

Thermo Scientific Orion 2111LL

Low Level Sodium Analyzer

UM-263639-004 • Revision C • October 2013

Contents

Section 1	General Information.....	6
	Introduction	6
	Markets	6
	Applications	7
	Features and Benefits.....	7
	Principles of Operation	8
	Principles of Calibration	9
	Double Known Addition (DKA)	10
	Offline Calibration.....	11
	Blank Correction.....	11
	Glossary.....	13
	Two Channel Analyzer Configurations.....	15
Section 2	Analyzer Preparation.....	16
	Unpacking the Analyzer.....	16
	Mounting and Plumbing Instructions.....	17
	Recommendations	17
	Instructions.....	17
	Sample Requirements	17
	Electrical Wiring.....	18
	Safety Requirements.....	18
	Warning Labels and Locations	19
	Wiring the Analyzer.....	19
	Required Tools.....	19
	Meter Inputs	20
	Terminal Assignments	21
	Electrode Wiring Assignments.....	21
	Installation of DIPA Reagent and Diffusion Tubing.....	23
	Recommendations	23
	DIPA Diffusion Tubing Assembly	23
	Diffusion Tubing Installation	24
	DIPA Reagent Bottle Installation	25
	Installation of New Electrode Cables	26
	Ferrite Installation.....	26
	Conditioning and Installation of a New Sodium Electrode	26
	Installation of the ATC Probe.....	27
	Installation of a New Reference Electrode.....	27
Section 3	Analyzer Operation.....	29
	Description of Basic Controls.....	29
	Description of Keypad Icons	31
	Use of the Setup Mode	32
	Navigating Tips for the Setup Mode	32
	Channel Specific Menu Options in the Setup Mode.....	33
	Using Password Protection	33
	Setup Mode Overview	34
	General Setup Mode Menu Options.....	34
	Channel Specific Setup Mode Menu Options.....	35
	Shutdown and Start-Up Procedure	62

Shutdown	62
Start-Up.....	63
Section 4 Calibration.....	64
Positioning the Valves for Calibration	64
Flow Cell Operation	66
Recommendations	66
Rinsing the Flow Cell.....	67
Air Regulation	68
Major Components of the Air Regulation System.....	68
Recommendations	68
Rinsing the Flow Cell.....	68
Before Performing a DKA Calibration	69
Recommendations	69
Performing a DKA Calibration.....	70
Calibration Abort Steps.....	73
Calibration Error Codes	74
Calibration At Custom Concentrations Using DKA	76
Span Check Procedure.....	77
Offline Calibration Procedure.....	77
Blank Correction Procedure.....	79
Section 5 Analyzer Maintenance	82
Maintenance Schedule	82
Recommendations	82
Weekly Maintenance	82
Monthly Maintenance.....	83
Conditioning the Sodium Electrode.....	83
Calibration.....	83
Replacement of the Reference Electrode Filling Solution	83
Replacement of the Sample Inlet Filter	84
Replacement of the DIPA Reagent and Diffusion Tubing Assembly.....	84
Notes on DIPA	86
Replacement of Reagent Manifold Face O-rings	86
Yearly Preventive Maintenance	86
Electrodes	86
Flow Cell	86
Replacement of the Restrictor Tubing.....	88
Section 6 Troubleshooting	89
Diagnostics Mode	89
Calibration Log.....	90
Error List.....	91
Measurement Log	92
Status Log.....	92
Software Revision	92
Electronics Serial Number.....	93
Model Number.....	93
mV and Noise Measurements	93
mA Output Values	93
Display Test	94
Keypad Test.....	95

Slope Problems	96
Low Slope	96
High Slope.....	97
Troubleshooting Matrix	97
Error/Event Codes	99
Resetting the Analyzer.....	103
Hard Reset.....	104
Serial Number and Software Revision	104
Service and Repair	104
Extended Warranty	104
Service Kit to Expand Standard Warranty.....	105
Advanced Replacement.....	105
Not sure which plan is best for you?.....	106
Installation and Start-Up.....	106
Remedial Service	106
Preventive Maintenance Programs	106
Section 7 Customer Service	107
Notice of Compliance.....	107
WEEE Compliance	108
Declaration of Conformity	108
Terms and Conditions.....	109
Contact Information.....	109
Minimum Order	109
Rush Orders.....	109
Returning Goods	109
Hazardous Materials	109
Restocking Charge.....	110
Short Shipments.....	110
Force Majeure	110
Warranty.....	110
Section 8 Appendix	112
Mounting Dimensions	112
ISE Default Values.....	113
Specifications.....	113
Ordering Information.....	117
Accessory Options	118
Field Replaceable Parts	118
Recommended Consumables for Annual Operation	119
Recommended Field Replaceable Spare Parts	120
Pipet Operation.....	120
Tip Ejection	120
Pipet Techniques.....	121
General	121
Forward Technique	121

1

SECTION 1 **General Information**

Introduction

This user guide covers the operation, maintenance and troubleshooting for the Thermo Scientific™ Orion™ 2111LL low level sodium analyzer, which incorporates state of the art technology designed for ease of use while offering the lowest limit of detection available.

Monitoring the sodium ion content of steam and water circuits to produce accurate and reproducible results requires a very well designed and maintained system. The system must optimize the fluidic design with the sensing technology to enable very low level (ppb) measurement of the contaminants as well as measuring across the linear range of the analyzer.

The 2111LL sodium analyzer meets all of the criteria for accurate and dependable sodium monitoring and more. The 2111LL incorporates patented technologies including:

- Thermo Scientific™ Orion™ ROSS™ and Thermo Scientific™ Orion™ ROSS Ultra™ electrodes
- Newly developed flow cell design
- Marquee help screen
- Pump-less reagent addition and DKA calibration system

Markets

- Power
- Semiconductor
- Chemical and petrochemical
- Pulp and paper

Applications

- Ultra pure water
- Boiler feed water
- Drum boiler water
- Ion exchange breakthrough
- Steam
- R/O system

Features and Benefits

The Thermo Scientific Orion 2111LL low level sodium analyzer meets all of the criteria for accurate and dependable sodium monitoring and more. Our 30 years of sensor expertise in sodium measurements combined with patented Thermo Scientific Orion technologies are skillfully incorporated in the 2111LL analyzer.

- Accurate and precise measurements even at the lowest levels of detection (range of 0.001 ppb to 10 ppm):
 - Reliable, low level measurements and wide range with selectable resolution.
- Patented ROSS Ultra® reference and ROSS® sensing electrodes:
 - Superior accuracy and stability over a wider temperature range.
- Patent-pending flow cell with air stirring and sample air transport:
 - Automatic sample handling and contamination control with no moving parts.
- Patented scrolling marquee:
 - Intuitive menu-driven digital operator interface.
- Data log of previous measurements and calibration:
 - Measurement, calibration and error history.
- Self diagnostics:
 - Ease of maintainability.
- Password protection:
 - Security and peace of mind for your operation.
- Auto-ranging electronics with large, backlit and easy to read LCD display:
 - Analyzer determines the best range.

Principles of Operation

The sample enters the Thermo Scientific Orion 2111LL sodium analyzer and passes through inlet valve, bypass valve assembly, inlet filter, pressure regulator, flow meter, calibration shut-off valve and into the restrictor tubing. The sample then passes through the reagent manifold into a reagent bottle through a diffusion tubing assembly where pH adjustment takes place. The pH adjusted sample then flows into the flow cell via the diverter valve, where air is introduced from the air pump to ensure proper mixing and fast response. The sample then flows into an atmospheric drain.

2111LL Schematic

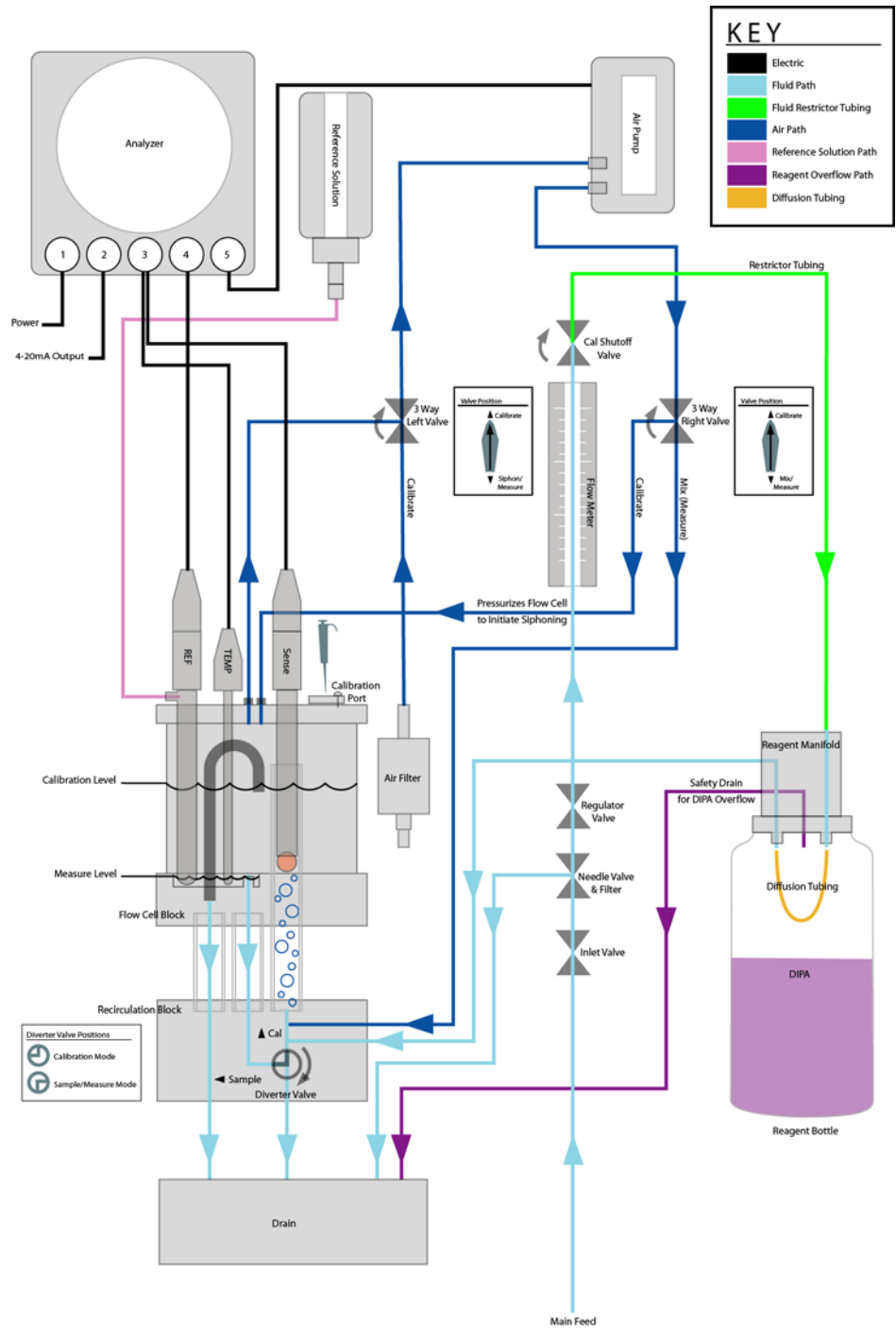

The sensing electrode responds logarithmically to changes in the sodium ion concentration. This response is described by the Nernst equation:

$$E = E_o + 2.3 (RT/nF) \log (C/C_{iso})$$

Where:

- E = measured electrode potential, mV
- E_o = potential, when C equals C_{iso}, mV
- R = ideal gas constant
- T = temperature of sample, degrees K
- n = valence of ionic species (+1 for sodium ion)
- F = Faraday's constant
- C = effective sodium ion concentration (activity)
- C_{iso} = concentration (activity) of sodium ion where potential E is temperature independent (isopotential point)

The above equation indicates that the measured potential varies with both temperature and the concentration of the ion of the interest. In order to eliminate error caused by fluctuations in sample temperature, the 2111LL microprocessor constantly updates temperature corrections from data supplied by the ATC probe.

From the Nernst equation, the theoretical response of a sodium ion-selective electrode to a ten-fold change in concentration at 25 °C is 59.16 mV. This is referred to as the electrode slope (S). Most electrodes, however, do not exhibit a theoretical slope. Therefore, the analyzer is calibrated to determine its actual value. Two standards are used to provide information necessary for the microprocessor to compute the actual slope and E₀ for use during sample analysis.

In order to eliminate interference from hydrogen ions, which can become significant when measuring low levels of sodium, the 2111LL analyzer adjusts sample pH to approximately 11. This pH adjustment is accomplished by the patented passive-diffusion process wherein the sample passes through a length of tubing contained in the reagent bottle. The reagent diffuses through the tube wall and mixes with the sample, raising sample pH to approximately 11.

Principles of Calibration

Calibration procedures for an analytical instruments are important and must be performed carefully. The calibration procedure used in the Thermo Scientific Orion 2111LL analyzer is a variation of Double Known Addition (DKA) using ROSS electrode technology and patent-pending flow cell technology in combination with the passive diffusion system. This method has the distinct advantages of being fast, easy, and accurate.

Double Known Addition (DKA)

Before calibration begins, the diverter valve is turned to divert flow from the measure drain to the re-circ tube, allowing the flow cell to fill.

The two air valves serve dual purposes during the calibration sequence.

The first function is to stop the airflow through the sample, and redirect the airflow to the headspace of the flow cell. Thus, the flow cell is filled without causing air bubble disturbance in the sensing tube. The second function ensures proper siphoning operation. The combination of these functions provides an accurate volume for calibration.

At the first step of the DKA calibration the actual concentration in the sample is unknown. The analyzer measures the potential (E_s) and stores this value in the microprocessor. A known amount of standard 1 solution is added to the flow cell, which increases the concentration (C_s) with a corresponding known amount (dC_1). During this process, air is pumped into the re-circ tube, thoroughly mixing sample and standard in a closed-loop system. The new potential (E_1) is measured and stored automatically when stability is reached. Adding standard 2, preferably 10 times more concentrated than standard 1, increases the concentration (dC_2) in the sample reservoir. Again, the new potential (E_2) is measured and stored when stable. Now, we have the following three unknowns:

$$E_s = E_o + S(T_s/298.15) \log (C_s/C_{iso})$$

$$E_1 = E_o + S(T_1/298.15) \log [(C_s + dC_1)/C_{iso}]$$

$$E_2 = E_o + S(T_2/298.15) \log [(C_s + dC_1 + dC_2)/C_{iso}]$$

S is the Slope at 25 °C (298.15 K)

T is the temperature in Kelvin, measured when the potential E is measured.

E_s , E_1 , E_2 have been determined during the calibration procedure. The microprocessor solves these three equations, to obtain the values of S and E_o . The calibration result is stored for use during online monitoring to convert the measured potential and temperature in the sample into concentration values in either ppm or ppb.

When the calibration is complete the flow cell drains as the sample flow returns. The flow cell volume returns to the measurement level. After allowing approximately 30 minutes for concentrated calibration solution to be flushed from the system, the 2111LL analyzer can begin sample measurement again.

In addition to Double Known Addition (DKA), the 2111LL analyzer also allows the operator the ability to perform an offline calibration.

Flow Cell Volume for DKA

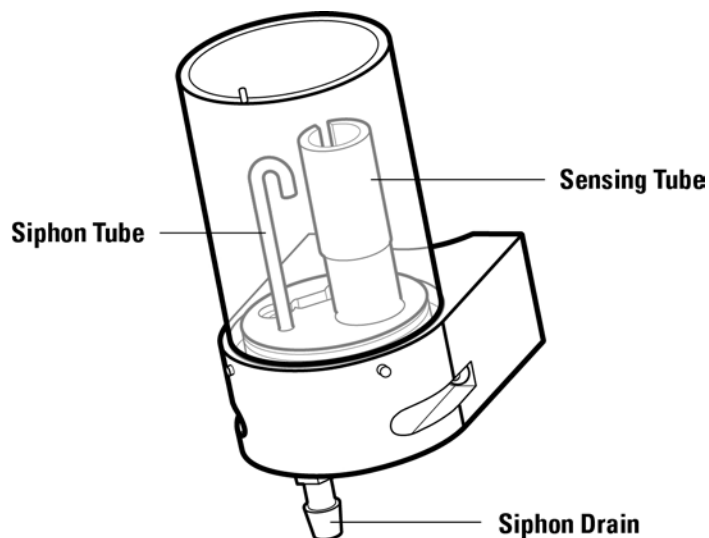

Offline Calibration

The offline calibration feature of the 2111LL analyzer allows the operator to adjust the analyzer to values determined by alternate methods used in their laboratory such as elemental spectroscopy and ion chromatography.

It is essentially a one point calibration. To perform offline calibration, a sample is taken from the bypass of the analyzer; the sample concentration value is stored in memory; the sample is analyzed by an alternate method of choice; the previously stored reading is adjusted to the lab method result; and the analyzer is then returned to the analysis mode. The term “offline calibration” refers only to the fact that a sample from 2111LL analyzer bypass is taken “offline” for laboratory analysis; in fact, no downtime is experienced during the procedure and the analyzer remains online throughout.

Blank Correction

The blank correction adds an offset to the measurement, and does not change the slope or E_0 value. The blank can be varied up to ± 1 ppb of the sodium reading to match alternate analysis values.

Fluidics Diagram

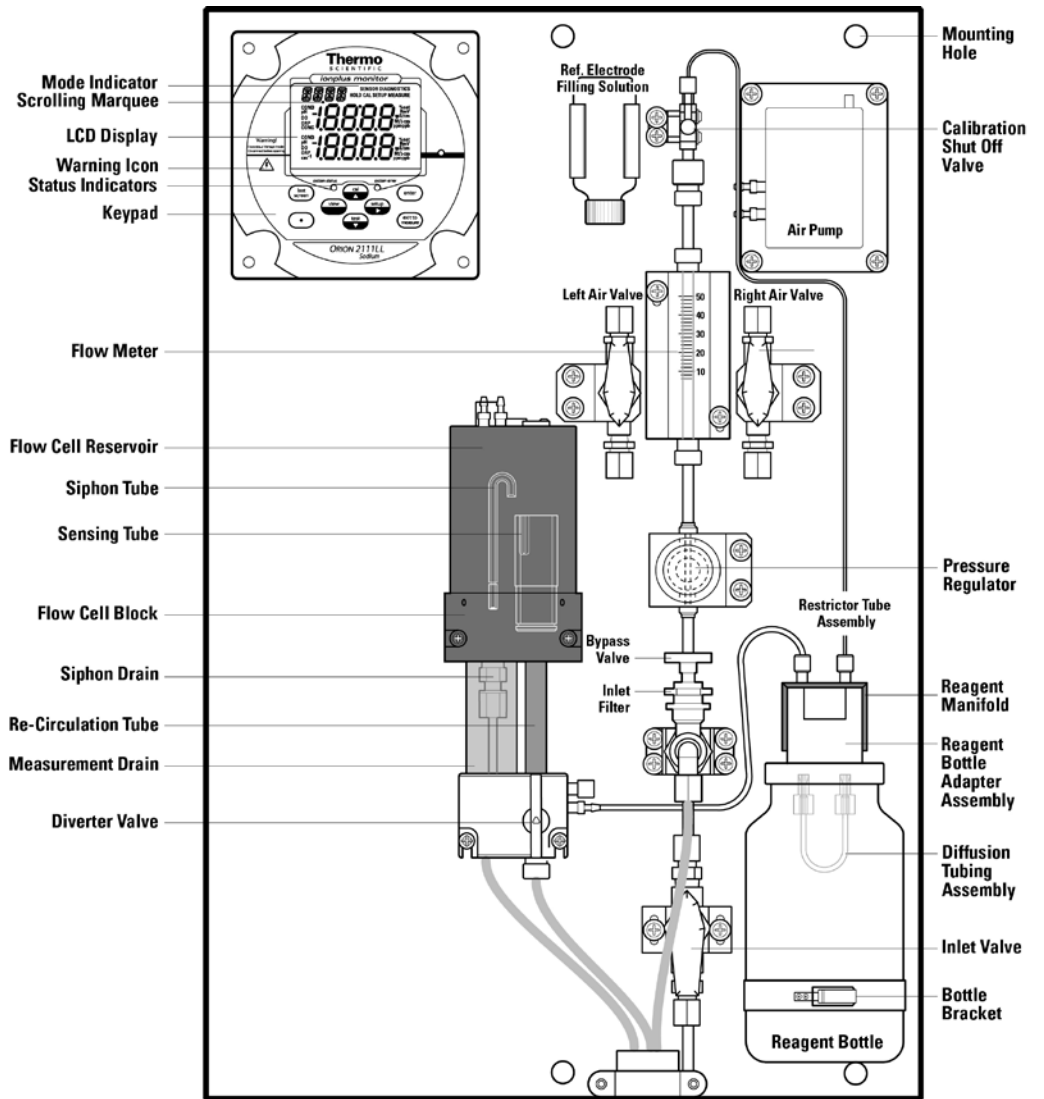

Fluidics Diagram (No Air Valves)

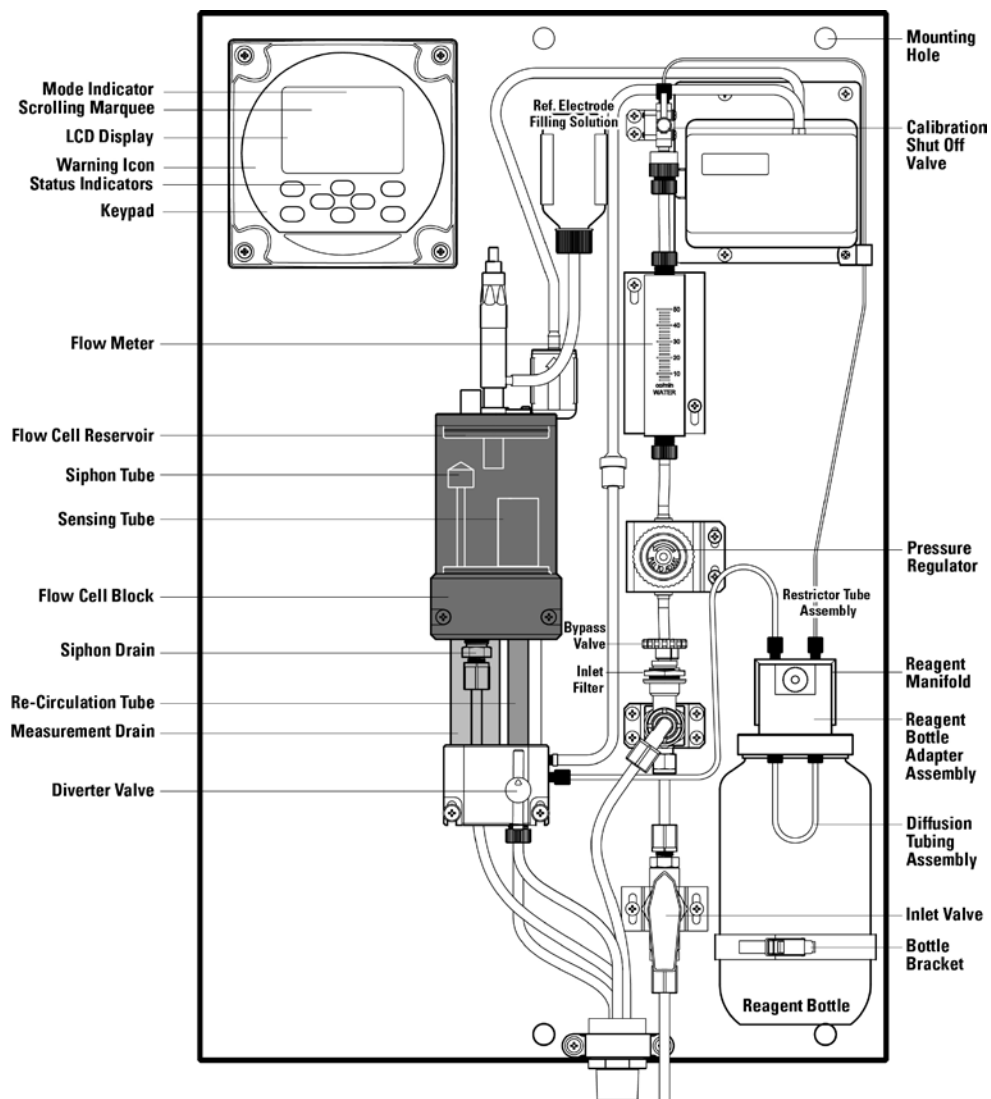

Glossary

Refer to 2111LL schematic diagram.

Inlet Valve – Accepts the sample stream via 1/4 inch NPTF connector. The operator must supply the sample with a pressure between 14 and 100 psig.

Inlet Filter – 60 micron stainless steel filter that traps particulate matter in the sample stream.

Bypass Valve – Used to redirect flow in the bypass system.

Pressure Regulator – Adjusts flow on the incoming sample stream.

Flow Meter – Measures the sample flow rate (40 mL/minute nominal).

Calibration Shut Off Valve – Used to stop the flow of sample from the flow meter to the restrictor tubing.

Restrictor Tube Assembly – Used in conjunction with the pressure regulator to lower downstream pressure.

Reagent Manifold – Directs the sample flow in and out of the reagent bottle assembly.

Reagent Bottle Adapter Assembly – Connects the reagent bottle assembly to the manifold.

Diffusion Tubing Assembly – Semi-permeable tubing through which reagent diffuses into the sample.

Reagent Bottle – Contains a water soluble amine, which raises the sample pH to approximately 11.

Reagent Bottle Bracket – Secures the reagent bottle.

Flow Cell – Contains the sodium sensing electrode, reference electrode and ATC probe.

Diverter Valve – Allows the flow cell reservoir to fill during calibration by forming a closed-loop system.

Re-circulation Tube – Tube through which sample (assisted by air) is pumped into the flow cell, used to mix solution in a closed-loop during calibration.

Sodium Electrode – Senses sodium ions in the sample stream and produces an electrical potential dependent on the sample concentration.

Reference Electrode – Provides a constant reference potential and completes the measurement circuit.

Reference Electrode Filling Solution Bottle – Provides constant flow of electrolyte solution through reference electrode for maximum stability.

ATC Probe – Measures sample temperature and inputs data to microprocessor for automatic temperature compensation (ATC).

Calibration Port – Allows introduction of standards to the sample reservoir during calibration.

Air Pump – Used to mix the sample during both measurement and calibration.

Right Air Valve – Adjusts airflow to the flow cell and controls airflow for mixing the sample.

Left Air Valve – Adjusts airflow to the flow cell and controls airflow for siphoning of the sample.

LCD Display – Provides digital readouts of concentration, temperature, millivolts and error codes.

Keypad – Consists of five mode keys, four prompt indicator lights, two scroll keys and one key for entering data. Mode and error indicators are also incorporated on keypad.

Status Indicator – Two LED lights that illuminate according to current status of the analyzer.

Green Light: Indicates that system is in correct working condition.

Yellow Light: Indicates a warning, system in hold or that maintenance is required.

Red Light: Indicates that something is seriously wrong.

Note: When either the yellow or red LED is lit, there may be an entry in the diagnostics mode that indicates the error. The logging feature must be initiated in the setup mode. Refer to Chapter III, Use of the Setup Mode for instructions.

Two Channel Analyzer Configurations

A pH/ORP module or conductivity module can be added by the operator to the second channel of the Thermo Scientific Orion 2111LL low level sodium analyzer for the ultimate flexibility in measurement capabilities. The 2100 series pH/ORP and conductivity analyzers provide accurate and reliable measurements in ultra pure water as well as the harshest industrial environments. Combined with decades of superior Thermo Scientific Orion sensor technology, our systems provide rapid results with complete stability.

Cat. No.	Description
2100PH2	Second channel module for pH/ORP
2100CD2	Second channel module for conductivity

When a pH/ORP module or conductivity module is installed on the second channel of the 2111LL sodium analyzer, refer to the *Thermo Scientific Orion 2100 Series pH/ORP Analyzer and Conductivity Analyzer User Guide* for detailed instructions on operating the pH/ORP or conductivity analyzer. Visit www.thermo.com/processwater to download any of the 2100 series analyzer user guides.

2

SECTION 2 Analyzer Preparation

Unpacking the Analyzer

Thermo Scientific Orion analyzers are assembled, tested and packaged with great care. Refer to the following diagram.

Report any obvious damage of shipping container to carrier and hold for inspection. The carrier (not Thermo Fisher Scientific) is responsible for any damage incurred during shipment.

1. Open the outer box. Remove the top two foam corner support pieces.
2. Open the inner box. This box should contain the analyzer and ATC temperature probe, sodium electrode box, reference electrode box, sodium standard solutions kit (two 2 oz. bottles of standard 1, 19.1 ppm sodium; two 2 oz. bottles of standard 2, 192 ppm sodium; and one 2 oz. bottle of etching solution), the options kit and user guide CD.
3. Remove the cardboard retaining shell by sliding it over the entire mounting board and the analyzer.
4. Carefully remove the entire mounting board with analyzer from the inner box.

Note: Do not lift or pull the analyzer by the fluidics or the electronic components.

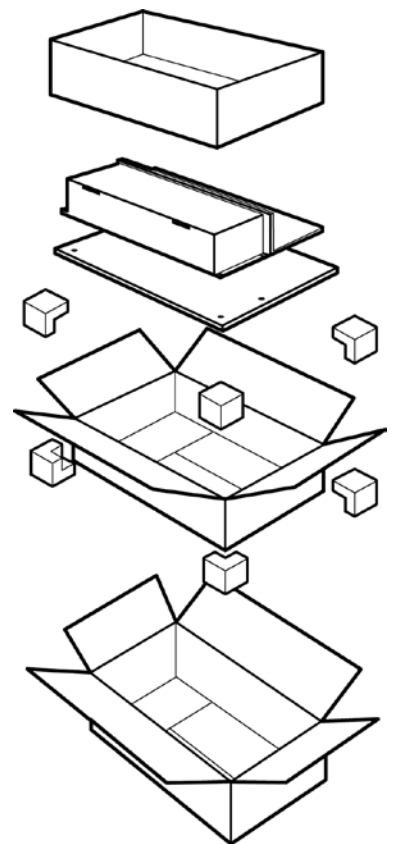

5. Unbolt the analyzer from the mounting board by removing the four mounting bolts with a 9/16 wrench. These bolts may be discarded.
6. Carefully place the analyzer at a convenient location until proper installation can be completed.

Mounting and Plumbing Instructions

Refer to **Section 8, Mounting Dimensions section**.

WARNING: Do not connect power prior to the mounting and plumbing of the analyzer.

Recommendations

- Select a site for the analyzer that allows it to be permanently bolted with ample height for atmospheric drain operation. Be sure that there is ready access to the electronic controls, calibration port and electrodes.
- A clearance of 15 inches (about 40 cm) must be allowed above the flow cell calibration port. Insert the pipet vertically (not angled) during the calibration.
- The analyzer location must permit connections to a sample line, drain and AC power supply and any connections for output devices.
- The analyzer should be mounted as close to the sampling point as possible. This ensures the fastest possible response to a changing sample condition. Refer to the **Section 8, Sample Conditions section**.
- For proper flow cell operation, the analyzer must be installed straight and level upon its mounting location. Failure to level the analyzer may cause poor siphoning in the flow cell.

Instructions

1. Prepare the mounting holes. Carefully lift the analyzer and bolt it into place. Do not lift the analyzer by holding on to any of the plumbing or fluid handling components.
2. Connect a waste line to the outlet of the analyzer, which is 3/4 NPT male. The waste line should be connected to a drain of sufficient capacity, 0.5 inch (1.27 cm) OD is recommended.
3. Connect a sample line to the inlet of the analyzer, which is 1/4 NPT female. It is recommended that a shutoff valve be installed at the sampling point.
4. The analyzer must be mounted and leveled vertically for proper operation.

Sample Requirements

Additional information is listed in the **Section 8, Specifications section**.

Sample inlet connection – 1/4" NPTF. If particulate matter is present in the sample, pre-filtration is necessary. The 60 micron stainless steel filter located after inlet valve will remove moderate amounts of particulates.

Flow rate – 40 mL/minute (nominal).

Pressure – 8 to 100 psig. Consult Technical Support for details on sample handling if the pressure is outside of this range.

Temperature – Temperature must be between 5 and 40 °C.

Sodium level – Sodium levels are read directly in ppb or ppm, when calibrated with Thermo Scientific Orion sodium standards 1 and 2 (Cat. No. 181140).

Sample alkalinity – Sample alkalinity should be less than 50 ppm CaCO₃ equivalent. For higher sample alkalinity, contact Technical Support.

Electrical Wiring

The warning icon highlights important information that should be strictly followed when using the analyzer for your own safety. Failure to follow these instructions may result in injuries.



WARNING: Read and observe the following safety recommendations.

Safety Requirements

- Prior to wiring, a switch or circuit breaker for disconnecting the analyzer from power supply should be installed.
 - The switch should be in close proximity to the analyzer and with easy reach of the user.
 - The switch should be marked as the disconnecting device for the analyzer.
- To reduce the risk of shock hazard, disconnect the power prior to opening the analyzer.
- Before connecting the analyzer to the main, make sure that the voltage lies within either range: 85 to 132 V, 200 mA or 170 to 264 V, 100 mA; 50 to 60 Hz AC.
- Cutting off the power by disconnecting power source will not reset the analyzer. This analyzer incorporates a non-volatile memory and will maintain calibration and settings after power failure. Battery power is supplied to the display for the date and time functions.
- If a repair is required, or to arrange Return Material Authorization, call Technical Support or contact your local authorized dealer.
- Installation and wiring of the analyzer may only be carried out in accordance with applicable local and national codes per this user guide.
- Be sure to observe the technical specifications and input ratings.

Warning Labels and Locations

WARNING: The following section provides important information that should be strictly followed when using the analyzer for your own safety. Failure to follow these instructions may result in injuries.

The safety warning icons are used in two locations on the analyzer.

- Faceplate.

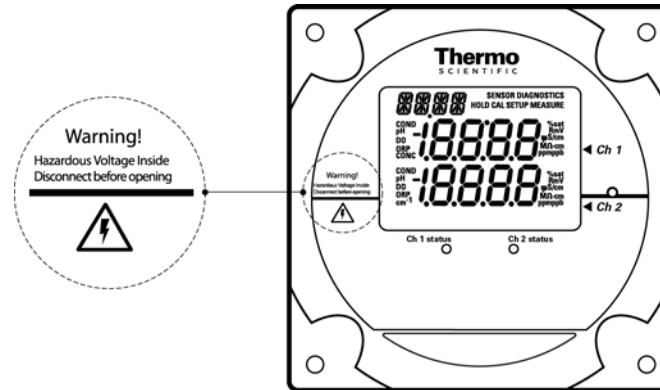

- Power supply.

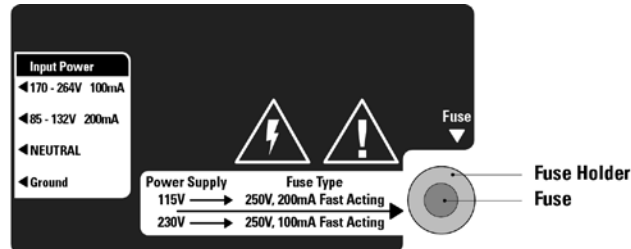

Note: Replace the fuse only with a fuse of same rating.

Wiring the Analyzer

WARNING: Read and observe the following requirements. If you install the wrong fuse for your system, you could damage the analyzer. Make sure that you select the correct fuse rating and discard the additional fuses supplied in the fuse kit.

Required Tools

- Options kit – includes fuses, cable glands, conduit fitting and green screw terminal.
- Phillips head screwdriver.
- 2 mm blade flat-head screwdriver.

Electronics Enclosure with Cable Glands

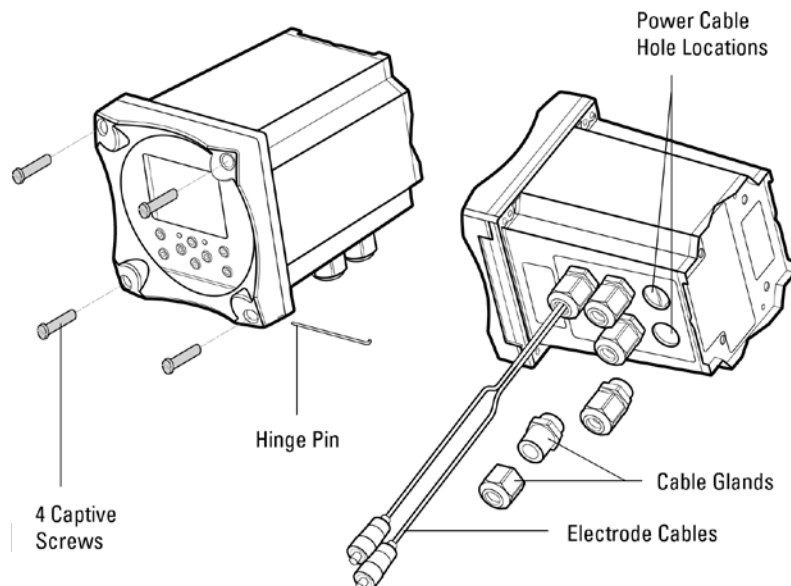

1. Open the faceplate – loosen the four screws using a Phillips head screwdriver. The electronics faceplate will open via the hinge pin connection.
2. Remove one or two of the two unused cable glands as required for wiring power cable or auxiliary connections. Power cable optional hole locations are shown in the figure above.
3. Select and install the appropriate size cable gland or conduit fitting as required.
4. Feed the power cable through the conduit or cable glands as required.



5. Wire the power cable to the green screw terminal connector from the options kit. Select correct terminal for hot conductor depending on line voltage. Refer to the figure above for terminal connector location.
6. Plug the terminal connector into the power supply. Refer to the power supply figure.
7. Select the correct fuse from the fuse kit. Install by inserting the fuse in the fuse holder and secure it using the twist and lock method. The fuses are clearly labeled with the appropriate voltages for your system. Refer to the power supply figure. Refer to the following table for fuse selection.

AC Voltage	Fuse Rating
115V	200mA
230V	100mA

Terminal Assignments

Terminal Layout		Terminal Layout		Terminal Layout		Terminal Layout	
1	Sout (mA) sensing signal	10	Relay 1	19	Solution ground	28	Do not connect
2	GND common ground	11	Relay 2	20	Conductivity drive +	29	Do not connect
3	Tout (mA) temp. signal	12	Relay 2	21	Conductivity sense +	30	Preamp power
4	Air pump (ISE only)	13	Relay 3	22	Conductivity sense -	31	Preamp ground
5	Air pump (ISE only)	14	Relay 3	23	Conductivity drive -	32	Shield
6	Shield ground for conductivity	15	Do not connect	24	Reference electrode	33	Shield
7	Do not connect	16	Temperature ground	25	Jumper to pin 24 when using preamp	34	Jumper to pin 26 when using preamp
8	Do not connect	17	Temperature drive	26	Sensing electrode		
9	Relay 1	18	Temperature sense	27	Do not connect		

Terminal Assignments

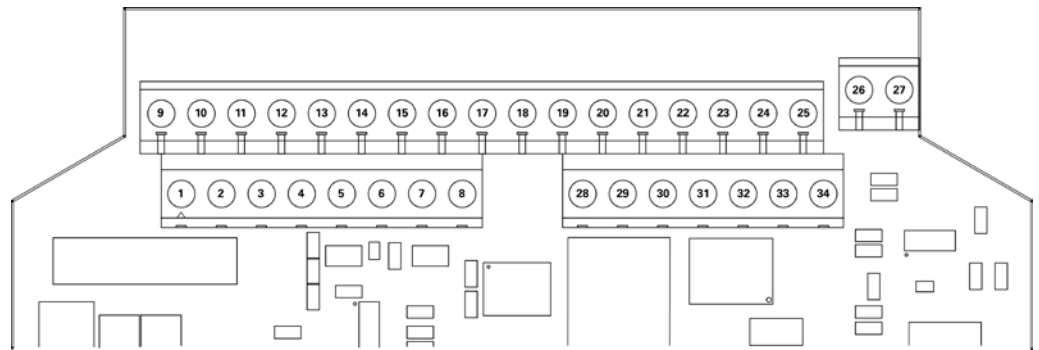

Electrode Wiring Assignments

Sodium Electrode		
26	Sensing electrode	Connect clear wire
33	Shield	Connect black wire

Reference Electrode

24	Reference electrode	Connect clear wire
32	Shield	Connect black wire

2100TP Temperature Probe

16	Temperature ground /thermistor	Connect white wire
17	Temperature drive /thermistor	Connect green wire
19	Solution ground	Connect red wire

2001TM Temperature Probe

16	Temperature ground /thermistor	Connect white wire
17	Temperature drive /thermistor	Connect green wire, jumper 17 and 18
18	Temperature sense	Jumper to 17
19	Solution ground	Connect red wire

2001SC pH Electrode

24	Reference electrode	Connect black wire
26	Sensing electrode	Connect clear wire

110250 ORP Electrode

19	Solution ground	Connect black wire
24	Reference electrode	Connect purple wire
26	Sensing electrode	Connect coax center wire

2002CC and 2002SS Conductivity Probes

6	Shield ground for conductivity	Connect clear wire
16	Temperature ground /thermistor	Connect white wire
17	Temperature drive /thermistor	Connect black wire
20	Conductivity drive +	Connect orange wire
21	Conductivity sense +	Connect red wire
22	Conductivity sense -	Connect green wire
23	Conductivity drive -	Connect blue wire

Note: Only reference the wiring configurations that are applicable to your analyzer and electrodes.

Installation of DIPA Reagent and Diffusion Tubing

WARNING: The diisopropylamine (DIPA) reagent is hazardous. Use protective glasses and gloves. Refer to the bottle label for precautions and work in a well-ventilated area. Installation of DIPA reagent requires a fume hood or well-ventilated area.

Recommendations

If the analyzer is offline or the sample flow is shut off from the analyzer for a prolonged period of time, follow the steps in Chapter III, Shutdown and Start-Up Procedure.

1. Unscrew the thumbnut and remove the reagent bottle from the reagent manifold.
 - New analyzers will ship with a rubber coated glass reagent bottle and complete diffusion tubing assembly installed. Only installation of the reagent is necessary for first time start-up.
2. Twist open the reagent bottle, separating the glass bottle, reagent bottle adapter assembly and plastic cap to the reagent bottle.

DIPA Diffusion Tubing Assembly

Designed to maximize uptime, our new diffusion tubing assembly can be replaced in a matter of seconds. Our method of snap and connect tubing installation combined with the easy pull off and dispose technique will have your system back online faster than ever before. The newly designed mechanism is precisely engineered to remain connected under variable temperature conditions and pressure fluctuations. The new style diffusion tubing assembly is now suspended in the headspace of the reagent bottle, which decreases the rate of consumption of reagent and saves you time and money.

The diffusion tubing ships fully assembled for quick and easy installation.

- Do not use Teflon tape during installation.
- Twisting of the clear silicone tubing will compromise tubing integrity and may cause ruptures. Be careful to avoid kinks and twisting during installation.

Note: The diffusion tube assembly mounts directly to the reagent bottle adapter fittings (2100RF). The reagent bottle adapter fittings are dedicated to the reagent bottle adapter and do not require change out when installing new diffusion tubing. Be sure to hand tighten these connectors monthly.

Diffusion Tubing Installation

Note: Turn off the air pump before beginning this procedure; otherwise, the air pump will splatter the reagent outward as the bottle is removed.

1. Remove the diffusion tubing assembly by unhooking the tubing from the hook, pulling off the two diffusion tubing caps and pulling the tubing off of the connectors, as shown in the following figures.

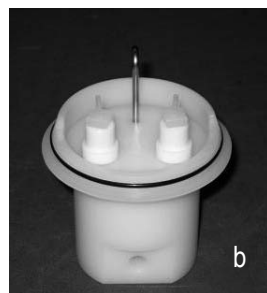
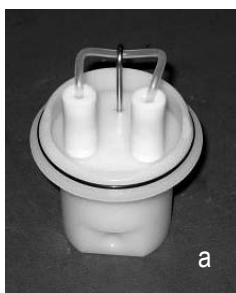

Diffusion Tubing Assembly

Note: Ensure the connectors are finger-tight to prevent possible leakage of sample into the reagent.

2. Check the new tubing assembly to make sure no black O-rings are caught in the caps. Remove if required. Press the diffusion tubing assembly on to the connector bars, as shown in Figure b. The holes at the tubing ends press onto the barb fitting.
3. Press the diffusion tubing assembly onto the connector bars, as shown in Figure c. The holes at the tubing ends press onto the barb fittings.

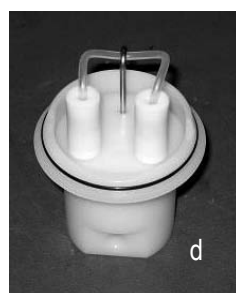
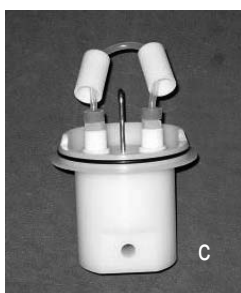

3. Press the diffusion tubing assembly caps onto the adaptors and loop the tubing onto the hook, as shown in Figure d.

Note: The length of the tubing should be equally balanced on the hook, to minimize the tubing touching the reagent. If using the 8 inch diffusion tubing, Cat. No. 211198, ensure that the tubing is above the DIPA reagent level. The 8 inch diffusion tubing may need to be looped twice onto the hook to keep the tubing above the liquid level.

DIPA Reagent Bottle Installation

1. Secure the diffusion tubing assembly to the base of the reagent bottle adapter assembly. The diffusion tubing adapter connectors must be perpendicular and straight when tightened into adapter assembly. Refer to Figure c.
2. Place a new reagent bottle on a flat surface and remove the cap. Ventilation or a hood is recommended for this step.
3. Holding the bottle steady with one hand, install the reagent bottle adapter assembly by tightening its cap onto the bottle. Ensure that the bottle label is oriented so that it will be visible when the entire assembly is mounted to the instrument.

Reagent Bottle Assembly

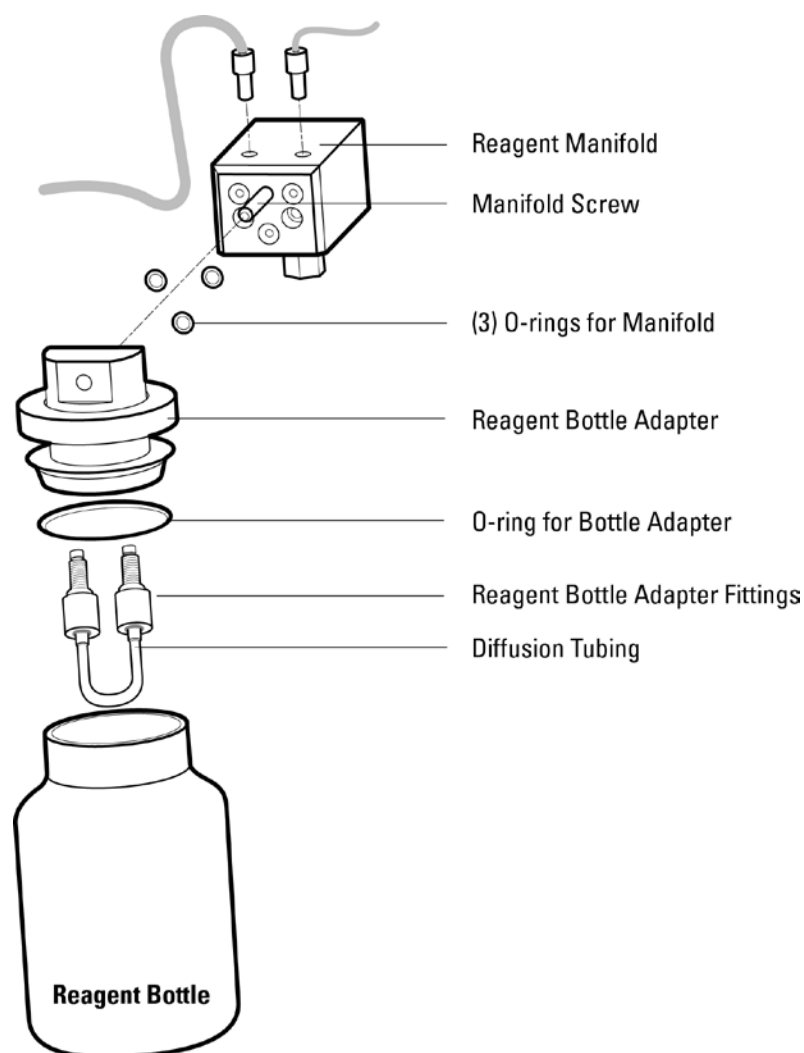

4. Replace the large single O-ring in the reagent bottle adapter assembly. Use needle nose pliers if necessary.
5. Replace all three O-rings on the face of the reagent manifold. Refer to the Reagent Bottle Assembly figure above.

6. Slide the reagent bottle adapter assembly over the threaded screw of the reagent manifold. Refer to the Reagent Bottle Assembly figure.
7. Tighten the thumbnut to secure the connection.

Installation of New Electrode Cables

1. Unpack the electrode cables.
2. Feed the tinned wires through the cable gland assemblies with the holes (2 or 1).
3. Follow the terminal assignments shown in Figure II-6 for the proper electrode cable wiring location.

Ferrite Installation

1. Open the ferrite using a flat tip screwdriver to lift the latch of the ferrite.
2. Feed the cable wires through the center of the ferrite and then loop the cable wires around the ferrite core and through the center of the ferrite again.
3. Place the ferrite at the bottom of the analyzer chassis, near its edge. Adjust the ferrite location on the cable so the ferrite is near the top of the cable.

Ferrite Installation

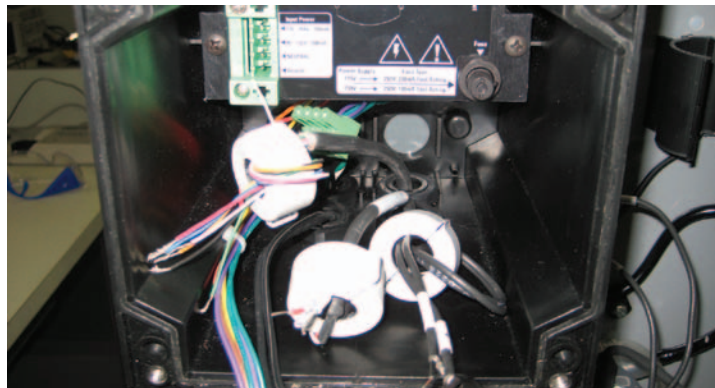

Conditioning and Installation of a New Sodium Electrode

The Thermo Scientific Orion sodium electrode (Cat. No. 210048) must be used in conjunction with the Thermo Scientific Orion reference electrode (Cat. No. 210058).

WARNING: Be sure to read and observe the following requirements. Only the sodium sensing electrode is etched. Do not etch the reference electrode. Safety glasses must be worn during the entire conditioning procedure. Gloves must be worn while etching the electrode.

1. Unpack the sodium electrode (Cat. No. 210048) and carefully remove the protective cap. Save the cap for future storage of the electrode.
2. Immerse the sodium electrode in the bottle of etch solution (Cat. No. 181113) for one minute.
3. Remove the sodium electrode from the bottle of etch solution and rinse it with deionized water. Gently blot the electrode bulb with a clean lab tissue paper. Rinse the electrode again with deionized water.
4. Insert the sodium electrode into its port in the flow cell cap. Refer to Figure II-12 for the location.

Flow Cell Cap



5. Plug the electrode cable marked "Sensing" into the top of the electrode. Be sure to push back the black cap to verify a secure connection between the male and female pin connection prior to tightening.
6. Tighten the screw cap connection to the cable.
Note: Do not twist the cable while tightening the connection. Twisting may cause damage requiring premature replacement of the cable.
7. Wait at least one hour before calibrating the analyzer.

Installation of the ATC Probe

The automatic temperature compensation (ATC) probe (Cat. No. 2100TP) is already connected to the correct terminal for temperature upon delivery.

Insert the ATC probe into its port in the flow cell cap. Refer to the figure above for the location.

Installation of a New Reference Electrode

1. Unpack the reference electrode (Cat. No. 210058) and its instruction sheet from the shipping box.
2. Carefully remove the protective caps from the bottom and sidearm of the reference electrode. Save the caps for future storage of the electrode.
3. Shake out as much of the fill solution as possible through the sidearm. Drain the fill solution through the sidearm or use a pipet or syringe.
4. While passing the 1/8 inch tubing into electrode sidearm, slide the 1/4 inch tubing over the sidearm. The outside tubing should extend 3/8 to 1/2 inches over sidearm. Refer to the following figure.

Reference Electrode with Filling Solution

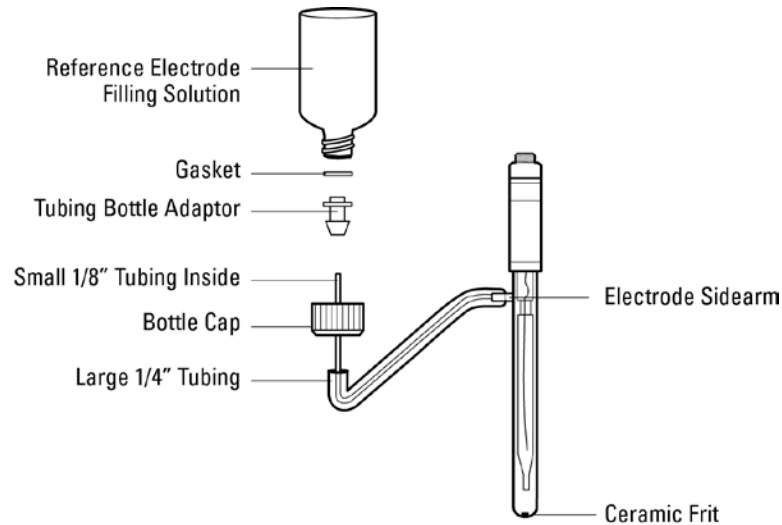

5. Remove the cap and fluid seal from reference electrode fill solution bottle (Cat. No. 211172). Hold the bottle in an upright position. Check that the rubber gasket is properly aligned, and then connect the cap end of the tubing assembly to the bottle. The 1/8 inch tubing should extend into the bottle.
6. Hold the reservoir bottle above the electrode with the bottle cap end down. The electrode should be horizontal with the sidearm pointing up. Gently shake the electrode to allow any trapped air bubbles to rise into the bottle as the electrode fills with solution.
7. Dry off the ceramic frit on the base of the electrode with a lint-free wipe. Squeeze the bottle for a few seconds. A small amount of filling solution should bead up on the frit surface, indicating good filling solution flow. If no moisture is visible, the electrode is clogged and should be cleaned or replaced.
8. Invert the electrolyte bottle and snap it into the clip. Refer to the following figure. Use the pushpin supplied with the reference electrode to puncture three air vents on the bottom of the filling solution bottle.

CAUTION: Failure to vent the filling solution bottle will lead to noisy and drifting output signals.
9. Plug the electrode cable marked "Reference" into the top of the electrode, and tighten the screw cap. Be sure to push back the black cap to verify a secure connection between the male and female pin connection prior to tightening.
10. Tighten the screw cap connection to the cable.

Note: Do not twist the cable while tightening the connection. Twisting may cause damage requiring premature replacement of the cable.
11. Insert the reference electrode into its port in the flow cell cap. Refer Flow Cell Cap figure for the location.

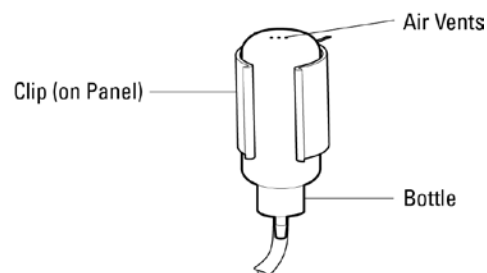

Reference Mounting Clip



3

SECTION 3 Analyzer Operation

Description of Basic Controls

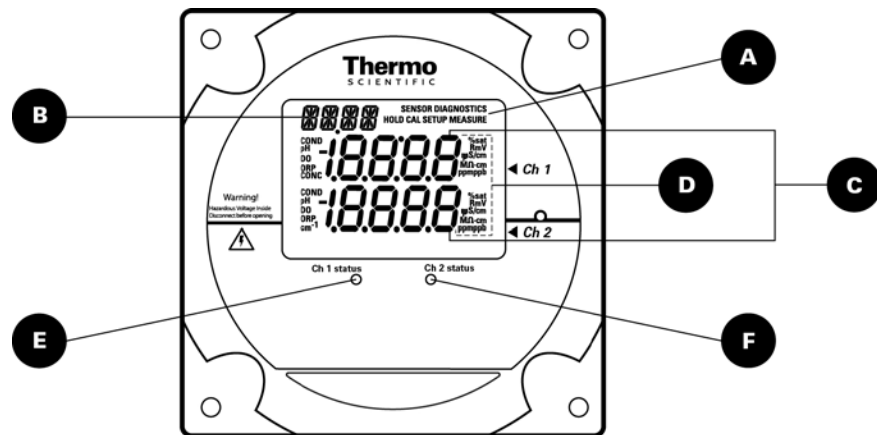
Faceplate









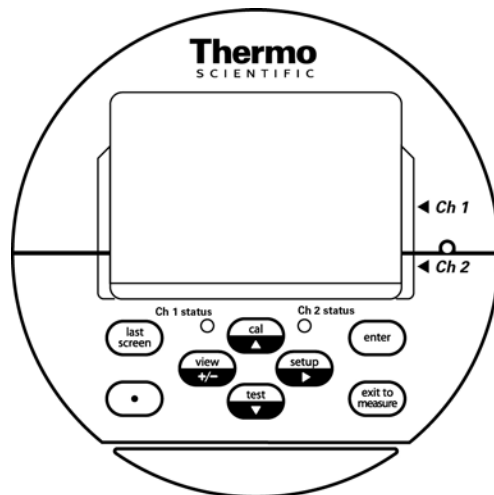

	Parameter	Location on Display	Options	Default
A	Mode Indicator	Top right corner of display	HOLD, CAL, SETUP, MEASURE, DIAGNOSTIC	MEASURE
B	Marquee Display	Top left corner of display	Analyzer provides prompts for operator using the scrolling message	
	Temperature Display		Celsius	In the measure mode, if an ATC probe is connected the default is the actual measured temperature and if no ATC probe is connected the default is 25 °C
C	Main Data Display	Middle line and bottom line of display	ISE board: concentration pH/mV board: pH or mV Conductivity board: conductivity, resistivity, salinity, concentration or TDS	Depends on type of board installed and selected measurement parameter
D	Measurement Units	Left and right side of middle and bottom display lines	ISE board: ppm or ppb, auto-ranging pH/mV board: pH or mV Conductivity board: μS/cm or mS/cm (conductivity), MΩ-cm (resistivity), SAL1 or SAL2 in the marquee (salinity), PCT1 or PCT2 in the marquee (concentration) and TDS1 or TDS2 in the marquee (TDS)	Depends on type of board installed and selected measurement parameter
E	Channel 1 Status Indicator	Below display screen, to the left of 	Green LED indicates that channel is OK Orange LED indicates a channel warning Red LED indicates a channel failure	At initial installation, the red LED indicates that the electrode or probe needs to be installed and calibrated.
F	Channel 2 Status Indicator	Below display screen, to the right of 	Green LED indicates that channel is OK Orange LED indicates a channel warning Red LED indicates a channel failure	At initial installation, the red LED indicates that the electrode or probe needs to be installed and calibrated.

Description of Keypad Icons

Keypad Icons















Key	Parameter/ Mode	Action	Operational Selections
	Enters calibration mode	Calibration mode with operator prompts	Depends on type of board installed
	Scrolls up digit numbers Scrolls up through a list of options in setup and cal modes	Use to edit numeric values Use to select available options	0 through 9 selectable by digit, first digit sometimes selectable 0 through 19
	Enters setup mode	System setup mode at the last parameter used by the operator	PASS, DATE, TIME, LOG, RSET, DISP, CH1, CH2, MDL, MEAS, HOLD, TCMP, TADJ, ALRM, mAMP, mADJ, TEST, CAL, PH, COND, DKA
	Moves to the next digit	Use to edit values	When moved to final digit, the system will wrap around to first digit
	Enters test mode	Use to advance through sequence of displays DIAGNOSTICS will appear in top right of screen	
	Scroll down digit numbers Scroll down through a list of options in setup and cal modes	Use to edit numeric values Use to select available options	0 through 9 selectable by digit, first digit sometimes selectable 0 through 19
	Enters log view mode	Use to view data in calibration, measure and status logs	
	+/- function	Enters negative/positive sign when editing numbers	
	Enter function	Use to accept value or selection displayed on screen and store value or selection in memory	
	Enter function (in test mode only)	Use in test mode to display additional information for selected menus	

Key	Parameter/ Mode	Action	Operational Selections
	Exit to measure function	Use to exit setup or cal modes and enter the measure mode	Analyzer automatically enters measure mode when first turned on and after calibration
	Last screen function	Use in setup and test modes to return to the previous screen or menu	
	Decimal point function	Use to set the decimal point position in certain menus with numbers that require a decimal point	

Use of the Setup Mode

Before the first sample measurements can be taken, the setup mode should be programmed and a successful calibration must be performed by the operator and stored in the memory of the analyzer.

Navigating Tips for the Setup Mode

- Press  to enter the setup mode.
- SETUP appears in the mode indicator screen.
- HOLD is displayed while in the setup mode.
- The analyzer will enter the setup mode at the last menu that was used by the operator.
- Press  and  to loop through the menu options.
- Press  to select the desired menu option and set the menu option parameters.
- Press  and  to:
 - Scroll between On and OFF for the selected menu option.
 - Scroll and set the first digit value to 0 through 19.
 - Scroll and set the remaining digit values to 0 through 9.
- Press  to move to the next digit (scroll right) to set each digit value (4 digits maximum).
- Press  to save the entered parameter for the selected menu option.
- Press  to exit the current screen and return to the previous screen.
- Press  to exit the setup mode and return to the measure mode. If  is pressed,  will not return the operator to the setup mode. The operator must reenter the setup mode by pressing .

Channel Specific Menu Options in the Setup Mode

If a single channel analyzer is in use, all of the menu options are accessible by pressing



in the setup mode. The system will loop through the menu options and all of the menu options are in the same level of the setup mode.

If a two channel analyzer is in use, only the general menu options are accessible by pressing



in the setup mode. The channel 1 and channel 2 specific menu options must be accessed by selecting the CH1 or CH2 menu options in the setup mode. The channel specific menu options are in the second level in setup mode. If a two channel analyzer is in use, make sure to program both the channel 1 and channel 2 menu options in the setup mode.

Using Password Protection

The default password is 0000 – indicates password protection has not been activated.

System password: Management secured password protection of setup mode and calibration process.

Calibration password: Operator secured password for protection of calibration process only.



If password(s) are activated:

- System prompts operator to enter system password:
- Marquee: ENTER PASSWORD
- Main display top: PASS
- Main display bottom: 0000 (flashing)
- Correct password – Allows operator to enter setup mode for custom programming options.
- Incorrect password – Password incorrect or not entered correctly.
- System password:
 - Marquee: SYSTEM PASS INCORRECT
 - Main display: E035
- Calibration password:
 - Marquee: CAL PASS INCORRECT
 - Main display: E034
- Verify password and re-enter it.

If password(s) are de-activated:

- System enters the setup mode at the last setup menu option used by the operator.
- Marquee: Flashes current menu option
- Main display: SEL SCrn

Setup Mode Overview

The setup mode features programmable menu options. The order of the menu options is dependent on the direction the operator scrolls by pressing  or . The menu options are listed below by pressing .

General Setup Mode Menu Options

The following menu options are displayed in the main setup mode of one and two channel analyzers.

PASS

Set either of two password options:

- System password – Setup settings protected, accessed by authorized operators only
- Calibration password – Calibration menu data is protected, accessed by authorized operators only
- Default password is 0000 – Disables both passwords
- Forgot your password? Contact Technical Support at 1-800-225-1480

DATE

Set the date in US or Europe format:

- Enter month, day and year
- Default date – System will continue to keep date and time due to battery back up, operator must set in accordance to local time zone
- If the battery is removed, the system will show 01/01/2000

TIME

Set the time:

- Enter hour and minutes in 24 hour format
- Default time – System will continue to keep date and time due to battery back up, operator must set in accordance to local time zone
- If the battery is removed the system will show 00:01

LOG

Set the data logging interval for measure log (calibration and error logs are accessed in the test mode):

- Set the log interval as hour:minute
- Default log interval is 00:00 – logging disabled
- Minimum log interval is 1 minute, maximum log interval is 99 hours and 59 minutes

RSET

Reset the analyzer to factory defaults for setup parameters:

- Use to troubleshoot the system (a hard reset can be performed if the keypad and software are not responding, refer to Chapter VI, Resetting the Analyzer)

WARNING: Resetting the analyzer will lose all stored information including relay, logs and calibration settings.

DISP

Set the automatic lighting options for the backlit display:

- AUtO – Brightness will change in response to ambient light source
- On – Backlit display is always on
- OFF – Backlit display is always off
- Default display – AUtO

Channel Specific Setup Mode Menu Options

If a two channel analyzer is in use, the following setup mode menu options are specific to the first channel of the 2111LL analyzer for sodium measurements. When a pH/ORP board or conductivity board is installed on the second channel of the 2111LL analyzer, refer to the **Thermo Scientific Orion 2100 Series pH/ORP Analyzer and Conductivity Analyzer User Guide** for detailed instructions on the second channel setup mode menu options.

CH1 or CH2

The operator must select the channel number in the main setup mode (CH1 or CH2) and the menu options that are relative to the measurement capability of that channel will be displayed. If a one channel analyzer is being used, the CH1 and CH2 menus will not be shown.

MEAS

Set the number of significant digits, mV display option and concentration units displayed when in the measure mode:

- Set the number of significant digits displayed measure mode
 - Scroll through 2, 3 or 4 significant digits
 - Default significant digits – 3
- Enable mV values to be displayed on the second line
 - Scroll between On or OFF
 - Default mV setting – OFF
- Set the displayed concentration units
 - Scroll through AUtO (automatically ranges from ppb to ppm), PPb (parts per billion, ppb), or PP (parts per million, ppm)
 - Default displayed concentration units – AUtO

HOLD

Set the time that the system will remain on hold before the actual measurements are displayed after a calibration:

- Once the hold time expires, the system implements any programmed changes to settings in the setup mode
- After a calibration, the hold function allows the operator to rinse the electrodes prior to recording actual measurement values
- Default hold time – 30 minutes

TADJ

Adjust the temperature reading from the ATC probe by ± 5.0 °C:

- Default adjustment – 0.0 degrees C

ALRM

Set up to three alarms – high, low and an error signaling contact:

- Relays 1 and 2 (rLY1, rLY2) are normally open dry contacts used to set high and low alarms for measurement values
 - rLY1 and rLY2 options – OFF, HI, LO
- Relay 3 (rLY3) is normally a closed contact that can be dedicated to errors (will close if power to analyzer is lost), this alarm is influenced by calibration, errors and offline or hold status
 - rLY3 options – OFF, CAL, HOLD, Err
- Default setting for all alarms – OFF

mAMP

Set the two analog current outputs (SOUt and tOUt):

- Scroll between 4-20 mA or 0-20 mA current signals
 - The outputs share a common return, but are isolated from the main circuitry of the analyzer
 - Default output current – 4-20 mA
- Scroll between logarithmic (LOg) and linear (LIn) scale for SOUt
- Set the low and high limits for the sensor output (SOUt)
 - Default – 1.0 ppb (low) and 100 ppb (high)
- Set the low and high limits for the temperature output (tOUt)
 - Default – 5.0 °C (low) and 45.0 °C (high)

mADJ

Set the mA offset adjustment value for the sensor (SOUt) and temperature (tOUt) outputs:

- Select the sensor (SOUt) or temperature (tOUt) output
- Scroll the numeric offset value and positive or negative offset value
- Default mA offset – 00.0 mA

TEST

Test relays and analog output lines (DIAGNOSTICS will appear in the mode indicator):

- Method to activate/deactivate relays and outputs to be tested
- Verify the accuracy of the analog outputs when used with an external loop calibrator
- Provides the values and settings for the mA output and relays
- mA output
 - 4-20 or 0-20
 - The sensor (SOuT) and temperature (TOuT) low and high values
- Relay status
 - Set RLY1, RLY2 and RLY3 status to OFF or On

CAL



Set calibration frequency in hours:



- High limit is 19999 hours
- Low limit is 00000 hours
- Default setting – 720 hours

















DKA













Set values for customized Double Known Addition (DKA):









- Programmable concentration (ppm) and volume (mL) of standard 1, concentration (ppm) and volume (mL) of standard 2, and whether the unit has air values or not.
- Flow cell volume: 190.0 mL
- Default concentration (Std1): 19.1 ppm
- Default volume addition (Std1): 0.10 mL
- Default concentration (Std2): 192.0 ppm
- Default volume addition (Std2): 0.10 mL
- Default model is dependent on the software version.
Latest software version will have No-Air-Valves as the default.









Default	Operator Action	Scrolling Marquee	Main Display	Notes
SETUP (One Channel Analyzer)				
	<p>Press  to enter setup mode</p> <ul style="list-style-type: none"> • SETUP appears as the mode indicator in the mode window • HOLD is displayed while in the setup mode • The system will enter the setup mode at the last saved menu option 	ASS DATE TIME LOG RSET DISP MEAS HOLD TADJ ALRM mAMP mADJ TEST CAL DKA	SEL SCrn	The displayed menu options depend on the measurement capability of the analyzer.
	<p>Press  to loop through the menu options</p>			
	<p>Press  to select the desired menu option and enter the submenu to customize setup parameters</p>			

Default	Operator Action	Scrolling Marquee	Main Display	Notes
	SETUP (Two Channel Analyzer)			
	<p>Press  to enter setup mode</p> <ul style="list-style-type: none"> • SETUP appears as the mode indicator in the mode window • HOLD is displayed while in the setup mode • The system will enter the setup mode at the last saved menu option 	<p>PASS DATE TIME LOG RSET DISP</p> <p>CH1 MEAS HOLD TADJ ALRM mAMP mADJ TEST CAL DKA</p> <p>CH2 MDL HOLD TCMP TADJ ALRM mAMP mADJ TEST CAL PH</p>	<p>SEL SCm SEL SCm SEL SCm SEL SCm SEL SCm SEL SCm</p> <p>SEL SCm SEL CH1 SEL CH1 SEL CH1 SEL CH1 SEL CH1 SEL CH1 SEL CH1 SEL CH1 SEL CH1</p> <p>SEL SCm SEL CH2 SEL CH2 SEL CH2 SEL CH2 SEL CH2 SEL CH2 SEL CH2 SEL CH2 SEL CH2</p>	<p>The list of menu options shown for CH2 are examples only. The displayed menu options for CH2 depend on the measurement capability of the channel.</p> <p>If only one board is installed in the analyzer, CH1 and CH2 will not be shown in the scrolling marquee and all of the menu options will be listed in the main setup mode.</p>
	Press  to loop through the menu options			
	Press  to select the desired menu option and enter the submenu to customize setup parameters			







Default	Operator Action	Scrolling Marquee	Main Display	Notes
	PASS	PASS (flashing)	SEL SCrn	
	Press  to set new passwords			
0 0 0 0		SET-UP NEW SYSTEM PASSWORD	PASS # # # # (first digit flashing)	
	Press  /  to set the first digit Press  to move to the next digit Press  /  to set the values of the remaining digits and press  to move through the remaining digits	SET-UP NEW SYSTEM PASSWORD	PASS # # # # (change flashing digit)	Do not scroll first digit above 9
	Press  to accept the system password and advance to the next screen to set the calibration password			
0 0 0 0		SET-UP NEW CALIBRATION PASSWORD	PASS # # # # (first digit flashing)	
	Press  /  to set the first digit Press  to move to the next digit Press  /  to set the values of the remaining digits and press  to move through the remaining digits	SET-UP NEW CALIBRATION PASSWORD	PASS # # # # (change flashing digit)	Do not scroll first digit above 9
	Press  to accept the calibration password and return to the main setup mode			
		PASS (flashing)	SEL SCrn	
	Press  to scroll to the next menu			

Default	Operator Action	Scrolling Marquee	Main Display	Notes
	DATE	DATE (flashing)	SEL SCm	
	Press  to set the date			
US		SET USA OR EUROPEAN	US (flashing)	
	Press  /  to scroll between US and EUR0	SET USA OR EUROPEAN	US or EUR0 (flashing)	
	Press  to accept the system password and advance to the next screen			
01/01/2000		ENTER DATE MM/DD/YYYY (US) or ENTER DATE DD/MM/YYYY (EUR0)	## . ## (Month . Day) 2 0 ## (Year) or ## . ## (Day . Month) 2 0 ## (Year) (first digit flashing)	
	Press  /  to set the first digit Press  to move to the next digit Press  /  to set the values of the remaining digits and press  to move through the remaining digits	ENTER DATE MM/DD/YYYY (US) or ENTER DATE DD/MM/YYYY (EUR0)	## . ## (Month . Day) 2 0 ## (Year) or ## . ## (Day . Month) 2 0 ## (Year) (change flashing digit)	
	Press  to accept the date setting and return to the main setup mode			
		DATE (flashing)	SEL SCm	
	Press  to scroll to the next menu			





Default	Operator Action	Scrolling Marquee	Main Display	Notes
	TIME	TIME (flashing)	SEL SCrM	
	Press  to set new passwords			
00:01		ENTER 24HR TIME HOUR/MINUTE	## : ## (hour : minute) (first digit flashing)	
	Press  /  to set the first digit Press  to move to the next digit Press  /  to set the values of the remaining digits and press  to move through the remaining digits	ENTER 24HR TIME HOUR/MINUTE	## : ## (hour : minute) (change flashing digit)	Set in 24 hour time format
	Press  to accept the time setting and return to the main setup mode			
		TIME (flashing)	SEL SCrM	
	Press  to scroll to the next menu			

Default	Operator Action	Scrolling Marquee	Main Display	Notes
	LOG	LOG (flashing)	SEL SCrn	
	Press  to set the log interval			
00:00		SET LOG TIME IN HOUR/MINUTE	## : ## (hour : minute) LOg (first digit flashing)	
	Press  /  to set the first digit Press  to move to the next digit Press  /  to set the values of the remaining digits and press  to move through the remaining digits	SET LOG TIME IN HOUR/MINUTE	## : ## (hour : minute) LOg (change flashing digit)	To disable the log enter 0000 for the log interval. The minimum log interval is 1 minute and the maximum log interval is 99 hours and 59 minutes
	Press  to accept the time setting and return to the main setup mode			
		LOG (flashing)	SEL SCrn	
	Press  to scroll to the next menu			





WARNING: The reset command will erase all operator settings, logs and calibration data. The analyzer will need to be set up and calibrated again before it can resume operation.





Default	Operator Action	Scrolling Marquee	Main Display	Notes
	RSET	RSET (flashing)	SEL SCrn	
	Press  to reset the analyzer			
		PUSH TEST VIEW ENTER TO RESET	rSet?	
	<p>To Reset the Analyzer:</p> <p>Press </p> <p>Press </p> <p>Press </p> <p>When the reset is complete, the system will return to the measure mode. The operator will need to re-enter the setup mode to continue programming the setup parameters. Press  to return to the setup mode.</p>	PUSH TEST VIEW ENTER TO RESET	rSet?	This command resets all previously set parameters to factory default values. Use this command only to set the analyzer to original factory setup values.
	<p>To Abort the Reset:</p> <p>Press  to return to the main setup mode</p>	PUSH TEST VIEW ENTER TO RESET	rSet?	
		RSET (flashing)	SEL SCrn	
	Press  to scroll to the next menu			













WARNING: Resetting the analyzer will erase all stored information including relay, logs and calibration settings.





















Default	Operator Action	Scrolling Marquee	Main Display	Notes
	DISP	DISP (flashing)	SEL SCrn	
	Press  to set the lighting option for the backlit display			
AUTO		BACK LITE	LITE AUTO (flashing)	
	Press  /  to scroll through AUTO, OFF and On settings	BACK LITE	LITE AUTO, OFF or On (flashing)	
	Press  to accept the display setting and return to the main setup mode			
		DISP (flashing)	SEL SCrn	
	Press  to scroll to the next menu			



Note: The following menu options are for analyzers with two boards installed only. If two channels are used, select the channel number in the main setup mode (CH1 or CH2) and additional menu options will be displayed.









Default	Operator Action	Scrolling Marquee	Main Display	Notes
	CH1	CH1 (flashing)	SEL SCrn	CH1 will not be shown in scrolling marquee if only one board is installed
	Press  to set the channel 1 specific menus in the setup mode			
	Press  to loop through the channel specific menu options	MEAS (flashing)	SEL CH1	
	Press  to select a menu option and customize the parameter (refer to the menu option displays that are shown on the following pages for detailed instructions)			
		CH1 (flashing)	SEL SCrn	
	Press  to scroll to the next menu			



Default	Operator Action	Scrolling Marquee	Main Display	Notes
	CH2	CH2 (flashing)	SEL SCrn	CH2 will not be shown in scrolling marquee if only one board is installed
	Press  to set the channel 2 specific menus in the setup mode			
	Press  to loop through the channel specific menu options	MDL (flashing)	SEL CH2	
	Press  to select a menu option and customize the parameter (when a pH/ORP or conductivity board is installed on channel 2, refer to the Thermo Scientific Orion 2100 Series pH/ORP Analyzer and Conductivity Analyzer User Guide for detailed instructions on the menu option displays)			
		CH2 (flashing)	SEL SCrn	
	Press  to scroll to the next menu			













Default	Operator Action	Scrolling Marquee	Main Display	Notes
	MEAS	MEAS (flashing)	SEL SCrn	
	Press  to set measurement parameters			
3		SET NUMBER OF SIGNIFICANT DIGITS	Slg 3 (flashing)	
	Press  /  to scroll through 2, 3 and 4	SET NUMBER OF SIGNIFICANT DIGITS	Slg 2, 3 or 4 (flashing)	
	Press  to accept the setting and advance to the next screen			
OFF		SHOW MV ON SINGLE CHANNEL DISPLAY	OFF (flashing)	
	Press  /  to scroll between OFF and On	SHOW MV ON SINGLE CHANNEL DISPLAY	OFF or On (flashing)	
	Press  to accept the setting and advance to the next screen			
AUTO		SELECT ISE UNIT	Unit AUTO (flashing)	
	Press  /  to scroll through AUTO, PPb and PP	SELECT ISE UNIT	Unit AUTO, PPb or PP (flashing)	PP is used as an abbreviation for ppm
	Press  to accept the setting and return to the main setup mode			
		CH1 or CH2 (flashing)	SEL SCrn	Displayed for two channel analyzer
	Press  to return to the channel specific menu options in the setup mode			Action required for two channel analyzer
		MEAS (flashing)	SEL SCrn	SEL CH1 or SEL CH2 on main display of two channel analyzer
	Press  to scroll to the next menu			

















Default	Operator Action	Scrolling Marquee	Main Display	Notes
	HOLD	HOLD (flashing)	SEL SCrn	SEL CH1 or SEL CH2 on main display of two channel analyzer
	Press  to set the hold time			
00:30		ENTER HOLD TIME HOUR/MINUTE	# # . # # (first digit flashing)	
	Press  /  to set the first digit Press  to move to the next digit Press  /  to set the values of the remaining digits and press  to move through the remaining digits	ENTER HOLD TIME HOUR/MINUTE	# # . # # (change flashing digit)	
	Press  to accept the setting and advance to the next screen			
LAST		ENTER HOLD STATE LAST OR USER VALUE	LAST (flashing)	
	Press  /  to scroll between LAST and USEr	ENTER HOLD STATE LAST OR USER VALUE	LAST or USEr (flashing)	
	Press  to accept the setting and advance to the next screen			
21.0		ENTER FIXED USER VALUE IN mA	# # . # (first digit flashing)	Displayed if USEr was selected in previous screen
	Press  /  to set the first digit Press  to move to the next digit Press  /  to set the values of the remaining digits and press  to move through the remaining digits	ENTER FIXED USER VALUE IN mA	# # . # (change flashing digit)	Action required if USEr was selected in previous screen
	Press  to accept the setting and advance to the next screen			Action required if USEr was selected in previous screen
OFF		HOLD TO 22mA WHEN ERROR	OFF (flashing)	
	Press  /  to scroll between OFF and On	HOLD TO 22mA WHEN ERROR	OFF or On (flashing)	

Default	Operator Action	Scrolling Marquee	Main Display	Notes
	HOLD	HOLD (flashing)	SEL SCrn	SEL CH1 or SEL CH2 on main display of two channel analyzer
	Press  to accept the setting and return to the main setup mode			
		CH1 or CH2 (flashing)	SEL SCrn	Displayed for two channel analyzer
	Press  to return to the channel specific menu options in the setup mode			Action required for two channel analyzer
		HOLD (flashing)	SEL SCrn	SEL CH1 or SEL CH2 on main display of two channel analyzer
	Press  to scroll to the next menu			















Default	Operator Action	Scrolling Marquee	Main Display	Notes
	TADJ	TADJ (flashing)	SEL SCrn	SEL CH1 or SEL CH2 on main display of two channel analyzer
	Press  to set the temperature adjustment value			
0.0 C		TEMPERATURE ADJUSTMENT	AdJ # . # c (first digit flashing)	
	Press  /  to set the first digit Press  to move to the next digit Press  /  to set the values of the remaining digits and press  to move through the remaining digits	TEMPERATURE ADJUSTMENT	AdJ # . # c (change flashing digit)	The maximum temperature adjustment is $\pm 5.0\text{ }^{\circ}\text{C}$
	Press  to set a positive or negative temperature value	TEMPERATURE ADJUSTMENT	AdJ - # . # c	
	Press  to accept the setting and return to the main setup mode			























Default	Operator Action	Scrolling Marquee	Main Display	Notes
	TADJ	TADJ (flashing)	SEL SCm	SEL CH1 or SEL CH2 on main display of two channel analyzer
		CH1 or CH2 (flashing)	SEL SCm	Displayed for two channel analyzer
	Press  to return to the channel specific menu options in the setup mode			Action required for two channel analyzer
	Press  to scroll to the next menu			



Default	Operator Action	Scrolling Marquee	Main Display	Notes
	ALRM	ALRM (flashing)	SEL SCm	SEL CH1 or SEL CH2 on main display of two channel analyzer
	Press  to set the alarms			
OFF		SELECT ALARM 1 HIGH LOW OR OFF	rLY1 OFF (flashing)	
	Press  /  to scroll through OFF, HI and LO	SELECT ALARM 1 HIGH LOW OR OFF	rLY1 OFF, HI or LO (flashing)	
	Press  to accept the setting and advance to the next screen			
100 ppb	Set the HI or LO value for rLY1: Press  to move the decimal point Press  /  to set the first digit Press  to move to the next digit Press  /  to set the values of the remaining digits and press  to move through the remaining digits	ENTER VALUE	rLY1 ##.## (change flashing digit)	Displayed if HI or LO was selected for rLY1 in previous screen
	Press  to set a positive or negative temperature value	TEMPERATURE ADJUSTMENT	AdJ -#. # c	





Default	Operator Action	Scrolling Marquee	Main Display	Notes
	ALRM	ALRM (flashing)	SEL SCm	SEL CH1 or SEL CH2 on main display of two channel analyzer
	Press  to accept the setting and advance to the next screen			Action required if HI or LO was selected for rLY1 in previous screen
OFF		SELECT ALARM 2 HIGH LOW OR OFF	rLY2 OFF (flashing)	
	Press  /  to scroll through OFF, HI and LO	SELECT ALARM 2 HIGH LOW OR OFF	rLY2 OFF, HI or LO (flashing)	
	Press  to accept the setting and advance to the next screen			
1 ppm	Set the HI or LO value for rLY1: Press  to move the decimal point Press  /  to set the first digit Press  to move to the next digit Press  /  to set the values of the remaining digits and press  to move through the remaining digits	ENTER VALUE	rLY2 ##.## (change flashing digit)	Displayed if HI or LO was selected for rLY2 in previous screen
	Press  to accept the setting and advance to the next screen			Action required if HI or LO was selected for rLY2 in previous screen
OFF		SELECT CALIBRATION HOLD ERROR OR OFF	rLY3 OFF (flashing)	
	Press  /  to scroll through OFF, CAL, HOlD and Err	SELECT CALIBRATION HOLD ERROR OR OFF	rLY3 OFF, CAL, HOLD or Err (flashing)	
	Press  to accept the setting and return to the main setup mode			
		CH1 or CH2 (flashing)	SEL SCm	Displayed for two channel analyzer
	Press  to return to the channel specific menu options in the setup mode			Action required for two channel analyzer













Default	Operator Action	Scrolling Marquee	Main Display	Notes
	ALRM	ALRM (flashing)	SEL SCm	SEL CH1 or SEL CH2 on main display of two channel analyzer
		ALRM (flashing)	SEL SCm	SEL CH1 or SEL CH2 on main display of two channel analyzer
	Press  to scroll to the next menu			



Default	Operator Action	Scrolling Marquee	Main Display	Notes
	mAMP	mAMP (flashing)	SEL SCm	SEL CH1 or SEL CH2 on main display of two channel analyzer
	Press  to set the analog output			
4-20	Press  /  to scroll between 4-20 and 0-20	SELECT 0-20 OR 4-20	4-20 or 0-20 (flashing)	
	Press  to accept the setting and advance to the next screen			
LOg	Press  /  to scroll between LOg and LIn	SELECT LOG OR LINEAR OUTPUT	SOUT LOg or LIn (flashing)	
	Press  to accept the setting and advance to the next screen			
1 ppb		mA SENSOR OUTPUT LOW VALUE	LO ###.# (first digit flashing)	
	Press  to move the decimal point Press  /  to set the first digit Press  to move to the next digit Press  /  to set the values of the remaining digits and press  to move through the remaining digits	mA SENSOR OUTPUT LOW VALUE	LO ###.# (change flashing digit)	









Default	Operator Action	Scrolling Marquee	Main Display	Notes
	mAMP	mAMP (flashing)	SEL SCm	SEL CH1 or SEL CH2 on main display of two channel analyzer
	Press  to accept the setting and advance to the next screen			
100 ppb		mA SENSOR OUTPUT HIGH VALUE	HI ###.# (first digit flashing)	
1 ppm	Press  to move the decimal point Press  /  to set the first digit Press  to move to the next digit Press  /  to set the values of the remaining digits and press  to move through the remaining digits	mA SENSOR OUTPUT HIGH VALUE	HI ###.# (change flashing digit)	
	Press  to accept the setting and advance to the next screen			
	Press  to set the temperature output value	SET TEMP OUTPUT VALUE	tOut	
05.0 C		mA TEMP OUTPUT LOW VALUE	LO ###.# c (first digit flashing)	
	Press  /  to set the first digit Press  to move to the next digit Press  /  to set the values of the remaining digits and press  to set a positive or negative temperature value	mA TEMP OUTPUT LOW VALUE	LO ###.# c (change flashing digit)	
	Press  to scroll to the next menu			
45.0 C		mA TEMP OUTPUT HIGH VALUE	HI ###.# c (first digit flashing)	
	Press  /  to set the first digit Press  to move to the next digit Press  /  to set the values of the remaining digits and press  to move through the remaining digits	mA TEMP OUTPUT HIGH VALUE	HI ###.# c (change flashing digit)	











Default	Operator Action	Scrolling Marquee	Main Display	Notes
	mAMP	mAMP (flashing)	SEL SCrn	SEL CH1 or SEL CH2 on main display of two channel analyzer
	Press  to accept the setting and return to the main setup mode			
		CH1 or CH2 (flashing)	SEL SCrn	Displayed for two channel analyzer
	Press  to return to the channel specific menu options in the setup mode			Action required for two channel analyzer
		mAMP (flashing)	SEL SCrn	SEL CH1 or SEL CH2 on main display of two channel analyzer
	Press  to scroll to the next menu			

















Default	Operator Action	Scrolling Marquee	Main Display	Notes
	mADJ	mADJ (flashing)	SEL SCrn	SEL CH1 or SEL CH2 on main display of two channel analyzer
	Press  to set the sensor and temperature mA offset values			
		SELECT TEMP OR SENSOR OUTPUT	SOUT or tOut (flashing)	
	Press  /  to scroll between SOUT or tOUT and select SOUT	SELECT TEMP OR SENSOR OUTPUT	SOUT (flashing)	
	Press  to accept the setting and advance to the next screen			
0.00		SENSOR 4-20mA OUTPUT ADJUSTMENT	AdJ 0 . 0 # (last flashing digit)	

Default	Operator Action	Scrolling Marquee	Main Display	Notes
	mADJ	mADJ (flashing)	SEL SCrn	SEL CH1 or SEL CH2 on main display of two channel analyzer
	Press  /  to set the sensor mA offset value Press  to set a positive or negative sensor mA offset	SENSOR 4-20mA OUTPUT ADJUSTMENT	Adj 0 . 0 # (last flashing digit)	
	Press  to accept the setting and return to the main setup mode			
		CH1 or CH2 (flashing)	SEL SCrn	Displayed for two channel analyzer
	Press  to return to the channel specific menu options in the setup mode			Action required for two channel analyzer
		mADJ (flashing)	SEL SCrn	SEL CH1 or SEL CH2 on main display of two channel analyzer
	Press  to set the sensor and temperature mA offset values			
		SELECT TEMP OR SENSOR OUTPUT	SOUt or tOUt (flashing)	
	Press  /  to scroll between SOUt or tOUt and select tOUt	SELECT TEMP OR SENSOR OUTPUT	tOUt (flashing)	
	Press  to accept the setting and advance to the next screen			
0.00		TEMP 4-20mA OUTPUT ADJUSTMENT	Adj 0 . 0 # (last flashing digit)	
	Press  /  to set the temperature mA offset value Press  to set a positive or negative temperature mA offset	TEMP 4-20mA OUTPUT ADJUSTMENT	Adj 0 . 0 # (change flashing digit)	
	Press  to accept the setting and return to the main setup mode			
		CH1 or CH2 (flashing)	SEL SCrn	Displayed for two channel analyzer











Default	Operator Action	Scrolling Marquee	Main Display	Notes
	mADJ	mADJ (flashing)	SEL SCrn	SEL CH1 or SEL CH2 on main display of two channel analyzer
	Press  to return to the channel specific menu options in the setup mode			Action required for two channel analyzer
		mADJ (flashing)	SEL SCrn	SEL CH1 or SEL CH2 on main display of two channel analyzer
	Press  to scroll to the next menu			















Default	Operator Action	Scrolling Marquee	Main Display	Notes
	TEST	TEST (flashing)	SEL SCrn	SEL CH1 or SEL CH2 on main display of two channel analyzer
	Press  to test the mA outputs (4-20) and relays (rLY)			DIAGNOSTICS appears above SETUP in mode window
4-20	To Test tOUt: Press  /  to scroll between 4-20 and rLY settings and select 4-20	SELECT mA OR RELAY	tEst 4 - 20 (flashing)	
	Press  to test 4-20 outputs			
		SELECT TEMP OR SENSOR OUTPUT	4 - 20 tOUt or SOUt (flashing)	
	Press  /  to scroll between SOUt and tOUt settings and select tOUt	SELECT TEMP OR SENSOR OUTPUT	4 - 20 tOUt (flashing)	
	Press  to display the tOUt low value			
Actual low value displayed		mA TEMP OUTPUT LOW VALUE	LO # . # c	4.0 mA are sourced at output terminal 11
	Press  to display the tOUt high value			



















Default	Operator Action	Scrolling Marquee	Main Display	Notes
	TEST	TEST (flashing)	SEL SCrn	SEL CH1 or SEL CH2 on main display of two channel analyzer
Actual high value displayed		mA TEMP OUTPUT HIGH VALUE	HI # . # c	
	Press  to accept the test and return to the main setup mode			
		CH1 or CH2 (flashing)	SEL SCrn	Display for two channel analyzer only
	Press  to return to the channel specific menu options in the setup mode			Action for two channel analyzer only
		TEST (flashing)	SEL SCrn	SEL CH1 or SEL CH2 on main display of two channel analyzer
	Press  to test the mA outputs (4-20) and relays (rLY)			
4-20	To Test SOUT: Press  /  to scroll between 4-20 and rLY settings and select 4-20	SELECT mA OR RELAY	tEst 4 - 20 (flashing)	
	Press  to test 4-20 outputs			
		SELECT TEMP OR SENSOR OUTPUT	4 - 20 tOUt or SOUt (flashing)	
	Press  /  to scroll between SOUT and tOUt settings and select SOUT	SELECT TEMP OR SENSOR OUTPUT	4 - 20 SOUT (flashing)	
	Press  to display the SOUT low value			
Actual low value displayed		mA SENSOR OUTPUT LOW VALUE	LO # . #	4.0 mA are sourced at output terminal 9
	Press  to display the SOUT high value			
Actual high value displayed		mA SENSOR OUTPUT HIGH VALUE	HI # . #	20.0 mA are sourced at output terminal 9

Default	Operator Action	Scrolling Marquee	Main Display	Notes
	TEST	TEST (flashing)	SEL SCrn	SEL CH1 or SEL CH2 on main display of two channel analyzer
	Press  to accept the test and return to the main setup mode			
		CH1 or CH2 (flashing)	SEL SCrn	Displayed for two channel analyzer
	Press  to return to the channel specific menu options in the setup mode			Action required for two channel analyzer
		TEST (flashing)	SEL SCrn	SEL CH1 or SEL CH2 on main display of two channel analyzer
	Press  to test the mA outputs (4-20) and relays (rLY)			
4-20	To Test rLY: Press  /  to scroll between 4-20 and rLY settings and select rLY	SELECT mA OR RELAY	tEst rLY (flashing)	
Actual rLY1 status	Press  to test relay outputs Press  /  to set the rLY1 setting OFF or On	USE ARROWS TO TOGGLE RELAY 1	rLY1 OFF or On	Relay contact according to screen indication
	Press  to accept the rLY1 test and move to the rLY2 test			
Actual rLY2 status	Press  /  to set the rLY2 setting OFF or On	USE ARROWS TO TOGGLE RELAY 2	rLY2 OFF or On	Relay contact according to screen indication
	Press  to accept the rLY2 test and move to the rLY3 test			
Actual rLY3 status	Press  /  to set the rLY3 setting OFF or On	USE ARROWS TO TOGGLE RELAY 3	rLY3 OFF or On	Relay contact according to screen indication
	Press  to accept the rLY3 test and return to the main setup mode			
		CH1 or CH2 (flashing)	SEL SCrn	Displayed for two channel analyzer
	Press  to return to the channel specific menu options in the setup mode			Action required for two channel analyzer

Default	Operator Action	Scrolling Marquee	Main Display	Notes
	TEST	TEST (flashing)	SEL SCrn	SEL CH1 or SEL CH2 on main display of two channel analyzer
		TEST (flashing)	SEL SCrn	SEL CH1 or SEL CH2 on main display of two channel analyzer
	Press  to scroll to the next menu			

Default	Operator Action	Scrolling Marquee	Main Display	Notes
	CAL	CAL (flashing)	SEL SCrn	SEL CH1 or SEL CH2 on main display of two channel analyzer
	Press  to set the required calibration frequency			
0720		ENTER CALIBRATION FREQUENCY IN HOURS	CAL #### (first digit flashing)	To disable the calibration alarm, set the value to 0000
	Press  /  to set the first digit Press  to move to the next digit Press  /  to set the values of the remaining digits and press  to move through the remaining digits	ENTER CALIBRATION FREQUENCY IN HOURS	CAL #### (change flashing digit)	The maximum temperature adjustment is ± 5.0 °C
	Press  to accept the setting and return to the main setup mode			
		CH1 or CH2 (flashing)	SEL SCrn	Displayed for two channel analyzer
	Press  to return to the channel specific menu options in the setup mode			Action required for two channel analyzer
	Press  to scroll to the next menu			

Default	Operator Action	Scrolling Marquee	Main Display	Notes
	DKA	DKA (flashing)	SEL SCrn	SEL CH1 or SEL CH2 on main display of two channel analyzer
	Press  to set custom DKA settings for the electrode calibration			
19.1 ppm		SET STD1 CONCENTRATION	COnc ###.# (flashing)	
	Press  /  to set the first digit Press  to move to the next digit Press  /  to set the values of the remaining digits and press  to move through the remaining digits	SET STD1 CONCENTRATION	COnc ###.# (change flashing digit)	
	Press  to accept the setting and advance to the next screen			
0.1 mL		SET STD1 VOLUME IN mL	Std1 ##.## (flashing)	
	Press  /  to set the first digit Press  to move to the next digit Press  /  to set the values of the remaining digits and press  to move through the remaining digits	SET STD1 VOLUME IN mL	Std1 ##.## (change flashing digit)	
	Press  to accept the setting and advance to the next screen			
192 ppm		SET STD2 CONCENTRATION	COnc ###.# (flashing)	

Default	Operator Action	Scrolling Marquee	Main Display	Notes
	DKA	DKA (flashing)	SEL SCm	SEL CH1 or SEL CH2 on main display of two channel analyzer
	Press  /  to set the first digit Press  to move to the next digit Press  /  to set the values of the remaining digits and press  to move through the remaining digits	SET STD2 CONCENTRATION	COnC ###.# (change flashing digit)	
	Press  to accept the setting and advance to the next screen			
0.1 mL		SET STD2 VOLUME IN mL	Std2 ##.## (flashing)	
	Press  /  to set the first digit Press  to move to the next digit Press  /  to set the values of the remaining digits and press  to move through the remaining digits	SET STD2 VOLUME IN mL	Std2 ##.## (change flashing digit)	
	Press  to accept the setting and advance to the next screen			
nO-A depending on software version	Press  /  to scroll between nO-A and A Press  to accept the setting and return to the main setup mode	SELECT NO AIR VALVES OR AIR VALVES RESENT	nO-A or A (flashing)	
		CH1 or CH2 (flashing)	SEL SCm	Displayed for two channel analyzer
	Press  to return to the channel specific menu options in the setup mode			Action required for two channel analyzer
		DKA (flashing)	SEL SCm	SEL CH1 or SEL CH2 on main display of two channel analyzer
	Press  to scroll to the next menu			

Shutdown and Start-Up Procedure

The following steps should be taken if a loss of sample flow is expected for more than one day. These procedures will prevent possible build-up of caustic reagent vapors in the analyzer.











Shutdown

WARNING: Be sure to read and observe the following requirements.

Air Pump Shutdown

DANGER: Turn off the air pump prior to removing reagent bottle.

The air pump will spatter caustic reagent outward as bottle is removed. Wear rubber gloves and safety goggles to avoid possible injury from reagent residues in the system.

1. To access air pump, press .
2. Press  /  to scroll through parameters until TEST appears in marquee window.
3. Press  to access the TEST menu.
4. Press  /  to scroll through the TEST menu until Air appears in the main display.
5. Press .
6. Press  /  to toggle between On and OFF settings for the air pump power. Select the OFF setting. Changing the air pump setting to On or OFF will be indicated by a click sound.
7. Press  to accept the setting and return to the TEST menu.
8. Press  to return to the measure mode.

Analyzer Shutdown

1. Shut off sample flow prior to the analyzer inlet. Refer to **Section 4, Flow Regulation**.
2. Disconnect the power. Refer to **Section 2, Wiring the Analyzer**.
3. Drain the flow cell.
4. Remove the reagent bottle and store it in a well-ventilated area such as a laboratory fume hood.
5. Carefully pull the sodium and reference electrodes out of the top of the flow cell and let them hang by their connectors.
6. Locate the protective cap from reference electrode kit and place it on the base of the reference electrode to prevent it from drying out.

Start-Up

1. Replace the diffusion tubing if the sample flow was off for more than a few days. Tubing becomes brittle with long-term exposure to the reagent. If the age of the reagent is not known, replace it and note
2. the date in the maintenance records. Re-install the reagent bottle on
3. the analyzer.
4. Restore sample flow to the analyzer. If necessary, adjust pressure and flow rate through the analyzer to 40 mL/min.
5. Remove the protective cap from the reference electrode. Re-install the electrodes on the analyzer. Be careful not to disconnect the reservoir tubing from the reference electrode sidearm.
6. Allow the analyzer to stabilize for approximately 1 hour and then recalibrate. Refer to **Section 4, Performing a DKA Calibration.**

4

SECTION 4 Calibration

Positioning the Valves for Calibration

The following figure represents the valve positioning for the Thermo Scientific Orion 2111LL low level sodium analyzer during measurement and calibration modes. This quick reference tool indicates the proper position of the 4 main valves used when starting calibrating the analyzer.

- Calibration shut off valve
- Left and Right air valves (some models)
- Diverter valve

Each 2111LL analyzer with air valves, is shipped with a valve reference guide as a self-adhesive tool to mount either to the back PVC panel or on the inside of the 2111LL enclosure (Cat. No. 2100EN). Make sure the DKA model type is set correctly in Setup chapter III as Air or no-Air valves.

Using the Valve Reference Guide	
Measure Mode	Turn valves to black arrow position. (on some models)
Calibrate Mode	Turn valves to red arrow position. (on some models)
Flow Regulation	Turn valves indicated in blue to either open or close position for sample flow adjustment.

Valve Reference Guide

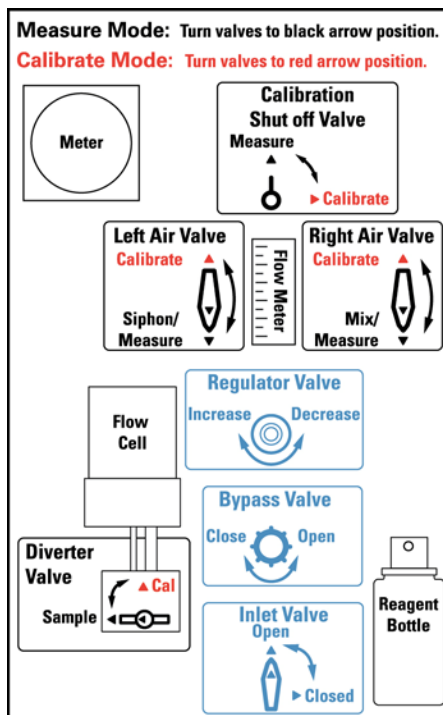

Figure A: Measurement mode showing both Left and Right air valves in the down position

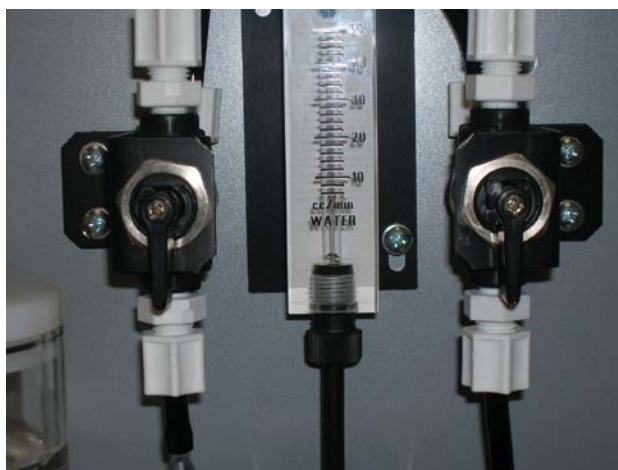

Figure B: Calibration starting position showing both Left and Right air valves in the up position



Flow Cell Operation

The sample reservoir in the flow cell, as shown in Figure IV-4, has two sample volumes: a normal operation volume of 20 mL and a highly accurate and individually calibrated flow cell volume of 190 mL. The lower volume results in fast system response while on-line, and the higher volume ensures accuracy in calibration.

When the 2111LL analyzer is first commissioned, it is advisable to flush out fluidics system overnight prior to the initial calibration and use.

The electronics need not be turned on at this time. Refer to **Section 4, Rinsing the Flow Cell**.

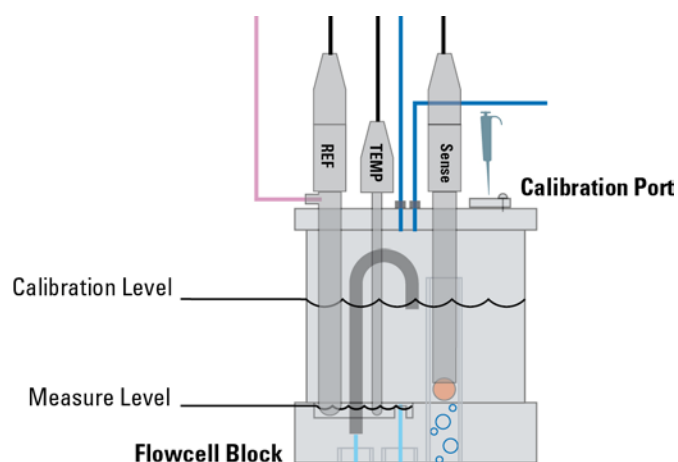

Recommendations

- For accurate volume displacement, install the sodium sensing electrode, reference electrode and ATC probe in their respective flow cell cap ports. Refer to **Section 2, Installation of a New Sodium Electrode**; **Section 2, Installation of a New Reference Electrode** and **Section 2, Installation of the ATC Probe**.
- Close the calibration port.
- When rinsing the flow cell before a low level standard calibration, be sure to rinse off the inside of the reservoir lid with deionized water to prevent buildup of sodium contamination along the lid.
- To ensure that the analyzer achieves stability and minimizes interference during calibration, the operator should minimize activity on the system during calibration.

Rinsing the Flow Cell

WARNING: Be sure to follow the air regulation procedure for rinsing the flow cell. Refer to Chapter IV, Air Regulation. Failure to initiate proper air settings will result in flow cell overflow. Sample will leak out of the top of the flow cell cap.

1. Open the calibration shut off valve, see **A** .
 - The open position shows the valve in a vertical position facing up.
2. Open the sample inlet valve, see **B** .
 - Position the valve with the pointed end facing up for open position.
3. Open the bypass valve by turning it counterclockwise, see **C** .
 - Check for the appropriate sample flow.
 - Adjust the pressure regulator if required. See step 4.
4. Adjust the knob on the regulator, see **E** , so the ball of the flow meter reads 40 mL/minute, see **D** .
 - Pulling the knob will unlock the setting and allow adjustment.
 - Turning the knob clockwise will increase flow.
 - Turning the knob counterclockwise will decrease flow.
 - Pushing the knob back in will lock into position.
5. Turn the arrow on the diverter valve to the cal position, with the arrow pointing up. Refer to **Section 4, Positioning the Valves for Calibration** .
 - The flow cell will begin to fill.
6. Continue to flush the flow cell for up to 60 minutes. The sample will drain from the siphon tube into the siphon drain to the waste.
7. Proceed with a DKA calibration. Refer to Section 4, **Before Performing a DKA Calibration** .

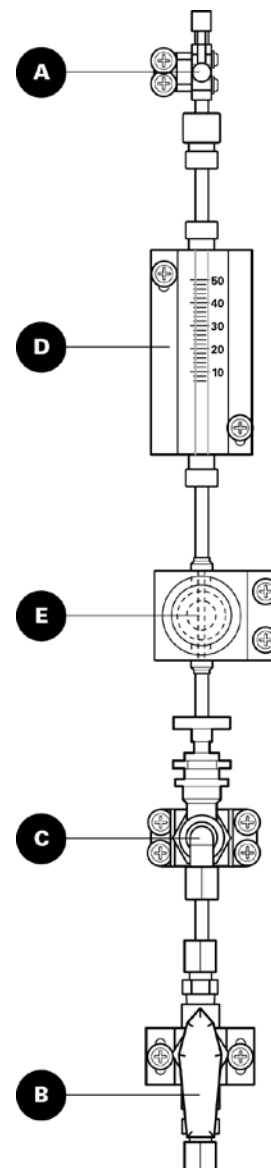

Air Regulation

The 2111LL analyzer utilizes pressure, gravity and fluid dynamics as the principal force of operation for the fluidic system.

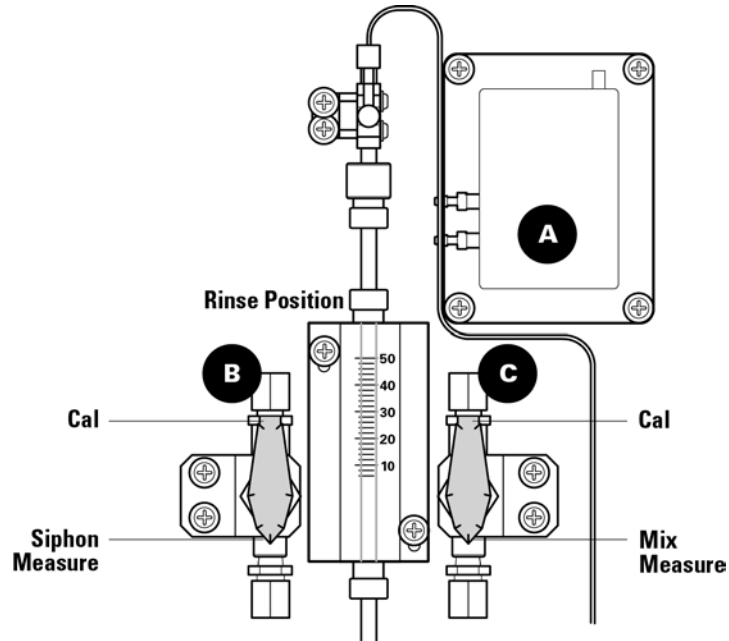

Major Components of the Air Regulation System

- Air pump, see **A**.
- Left air valve, see **B**. (some models)
- Right air valve, see **C**. (some models)

Recommendations

- Airflow regulation is critical to proper siphoning, mixing and operation of the flow cell during measurement and calibration modes.
- Successful air regulation requires proper air pump operation.

Rinsing the Flow Cell

1. On models with air valves, make sure the right air valve and left air valve (Figure A) are pointing down in the measure position.
2. At this point refer to **Section 4, Rinsing the Flow Cell** for proper fluid flow to rinse the flow cell.

Before Performing a DKA Calibration

Maximum system accuracy is ensured through a fast, easy and accurate calibration performed in the expected sample range. This calibration procedure uses equipment supplied in calibration kit (Cat. No. 181148).

Recommendations

- Perform monthly maintenance procedures including the conditioning of the sodium electrode.
- Wait at least one hour after changing the reagent or etching the sodium sensing electrode. Calibration must be initiated within 2 to 3 hours of etching the sodium electrode to ensure faster response.
- Check that present sample concentration is equal or less than standard 1 (10 ppb). If not, calibration can still be performed with a loss in accuracy as long as the background concentration is not significantly larger than the concentration of standard 1. Accuracy can be attained if alternate standards are employed but standard 1 should not be less than 10 ppb.
- Proper pipet technique is crucial to calibration. If the operator is not familiar with the pipet equipment or technique, refer to the Appendix, Pipet Operation section.
- Do not touch the pipet tip with bare fingers. Risk of contamination is possible. Use powder free gloves to prevent contamination.
- When using the pipet to inject standards during calibration, use a fresh pipet tip for each standard concentration and each injection.
- With a fresh tip installed, rinse the tip with the same concentration as the intended injection.
- Fill the tip and dispense the tip with the standard 1 to 3 times.
- Be sure to discard the standard in the drain between the rinses.
- Wipe any excess liquid from the outside of the tip without touching the opening.
- Insert the pipet tip into the calibration port on the flow cell cap.
- Be sure to hold the pipet completely vertical while dispensing.
- Do not inject any standard on the side of the flow cell, as a film may be retained on the inside of the wall resulting in errors in precision of calibration. Refer to the following figure.

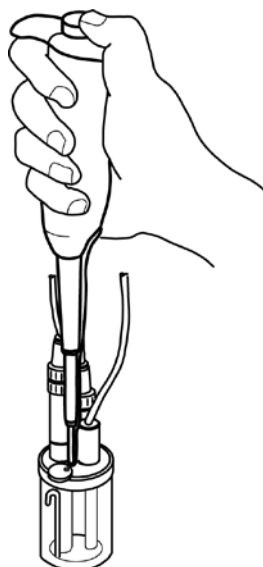























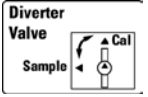

Pipet Dispensing

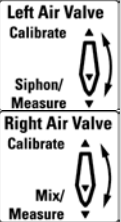

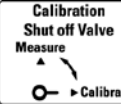

Performing a DKA Calibration

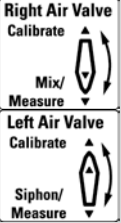

- To begin a DKA, the system starts from the measure mode. The air regulation must be in the following positions to perform step 1.
 - Calibration port is closed for proper flow cell pressure.
 - If the system has air valves, make sure both valves point down.

Note: Refer to **Section 4, Valve Reference Guide** for valve positions.

Step	Operator Action	Scrolling Marquee	Main Display	Notes
1	Make sure that the analyzer is in the measure mode.	Actual temperature reading	Actual concentration reading	
2	Press  to initiate the calibration.			CAL appears as mode
3	If the calibration password is active, enter the calibration password by pressing  /  to set the first digit,  to move to the next digit,  /  to set the values of the remaining digits and press  to move through the remaining digits. Press  to accept the password.	ENTER PASSWORD	PASS ####	
4		CH1 or CH2 (flashing)	CAL CHnL	Displayed for two channel analyzer
5	Press  /  to select the channel that will be calibrated and press  to begin the calibration.	CH1 or CH2 (flashing)	CAL CHnL	Action required for two channel analyzer
6		DKA, OFFL, or BLNK (flashing)	CAL tYPE	
7	Press  /  to select DKA and press  to accept the setting.	DKA (flashing)	CAL tYPE	
8	Follow the sodium electrode etching procedure in Section 2 and press  once the electrode is reinstalled in the flow cell.	ETCH SENSOR PRESS ENTER	EtCH SEnS	
9	Check that the cal port on the flow cell cap is closed. Turn the diverter valve to the cal position, arrow pointing up. Wait 60 minutes.	CHECK CAL PORT CLOSED TURN DIVERTER VALVE SO ARROW POINTS UP. WAIT 60 MINUTES	Actual concentration reading	 <p>The minutes will be counted down on marquee.</p>

Step	Operator Action	Scrolling Marquee	Main Display	Notes
10	Press  . * If no-Air-Valve 2111LL proceed to Step 12.	PRESS ENTER	Actual concentration reading	After 60 minutes the marquee will display PRESS ENTER.
11	Turn the left air valve to the calibrate position, arrow pointing up. Turn the right air valve to the calibrate position, arrow pointing up. Press  .	TURN LEFT AND RIGHT VALVES UP. PRESS ENTER	Air	
12	When the liquid level in the flow cell rises above the siphon tube and begins to drop, turn the calibration shut off valve (above flow meter) to the calibrate position. Press  .	WHEN LIQUID LEVEL BEGINS TO DROP TURN SHUTOFF VALVE RIGHT. PRESS ENTER	FLO OFF	
13	Turn the left air valve to the siphon position, arrow pointing down. The fluid passing through the siphon to the drain will be observed. Press  .	TURN LEFT VALVE DOWN PRESS ENTER	SIPH	
14	When the siphoning stops: Turn the left air valve to the calibrate position, arrow pointing up. Open the cal port on the flow cell cap. Turn the right air valve to the mix position, arrow pointing down. Press  .	WHEN SIPHONING STOPS TURN LEFT VALVE UP OPEN CAL PORT TURN RIGHT VALVE DOWN PRESS ENTER	Air	
15	Wait 4 minutes.	MEASURING BACKGROUND WAIT 4 MINUTES	Actual readings flashing	System circulates sample. Minutes will be counted down on the marquee.
16	Wait 0 to 5 minutes.	AWAITING DATA STABILITY	Actual readings flashing	System continuously evaluates the data until a stable condition is met. If there is a calibration error, the appropriate error message will be displayed.
17	Add standard 1 through the calibration port.	ADD STD1 PRESS ENTER	Add Std1	
18	Press  .	ADD STD1 PRESS ENTER	Add Std1	







Step	Operator Action	Scrolling Marquee	Main Display	Notes
19	Wait 3 minutes.	MEASURING STD1 WAIT 3 MINUTES	Actual readings flashing	System circulates sample. Minutes will be counted down on the marquee.
20	Wait 0 to 5 minutes.	AWAITING DATA STABILITY	Actual readings flashing	System continuously evaluates the data until a stable condition is met. If there is a calibration error, the appropriate error message will be displayed.
21	Add standard 2 through the calibration port.	ADD STD2 PRESS ENTER	Add Std2	
22	Press  .	ADD STD2 PRESS ENTER	Add Std2	
23	Wait 3 minutes.	MEASURING STD2 WAIT 3 MINUTES	Actual readings flashing	System circulates sample. Minutes will be counted down on the marquee.
24	Wait 0 to 5 minutes.	AWAITING DATA STABILITY	Actual readings flashing	System continuously evaluates the data until a stable condition is met. If there is a calibration error, the appropriate error message will be displayed.
25	No action necessary.			System calculates new E_0 and slope and checks for errors.
26	Press  to accept the new slope and E_0 values or Press  to abort the calibration. The new slope and E_0 values will not be saved. The last saved calibration prior to the aborted calibration will be used in the measure mode. * If no-Air-Valve 2111LL proceed to Step 28.	NEW CALIBRATION SLOPE AND E_0 PRESS ENTER TO ACCEPT OR PRESS EXIT TO ABORT WITHOUT SAVING	Calculated slope and E_0	If there is a calibration error, the appropriate error message will be displayed. If  is pressed, refer to the Calibration Abort Steps section.

Step	Operator Action	Scrolling Marquee	Main Display	Notes
27	<p>Turn the left air valve to the siphon position, arrow pointing down.</p> <p>Turn the right air valve to the mix position, arrow pointing down.</p> <p>Turn the diverter valve to the sample position, arrow pointing left.</p> <p>Turn the calibration shut off valve to the measure position, arrow pointing up.</p> <p>Close the port on the flow cell cap.</p> <p>Press  .</p> <p>* Proceed to Step 29.</p>	<p>TURN LEFT VALVE DOWN</p> <p>TURN DIVERTER VALVE SO ARROW POINTS LEFT</p> <p>TURN SHUTOFF VALVE UP</p> <p>CLOSE CAL PORT</p> <p>PRESS ENTER</p>	FLO On	
28	<p>Turn the diverter valve to the sample position, arrow pointing left.</p> <p>Turn the calibration shut off valve to the measure position, arrow pointing up.</p> <p>Close the port on the flow cell cap.</p> <p>Press  .</p>	<p>TURN DIVERTER VALVE SO ARROW POINTS LEFT</p> <p>TURN SHUTOFF VALVE UP</p> <p>CLOSE CAL PORT</p> <p>PRESS ENTER</p>	FLO On	
29	System will proceed to measure mode.	Actual temperature reading	Actual concentration reading	System enters measure mode, but will remain on hold until the hold timer expires. Default hold time is 30 minutes.

Calibration Abort Steps

The system allows the operator to abort the calibration or return to the calibration when  is pressed at any point during the calibration.









The following table lists the calibration abort steps with their marquee display and required operator actions.



Step	Operator Action	Scrolling Marquee	Main Display	Notes
Calibration Abort Exit Steps – If  is pressed at any point during the calibration, proceed with the following steps				
Exit 1		ARE YOU SURE? PRESS ENTER TO ABORT OR PRESS LAST SCREEN TO BACKUP	SUR ?	
Exit 2	Press  to abort the calibration. or Press  to return to the last screen used in the calibration sequence prior to when  was pressed. Continue to follow the calibration steps according to the marquee and main display directions.	ARE YOU SURE? PRESS ENTER TO ABORT OR PRESS LAST SCREEN TO BACKUP	SUR ?	
Exit 3		CALIBRATION ABORTED PRESS ENTER	CAL Abt	
Exit 4	Press  to abort the calibration.	CALIBRATION ABORTED PRESS ENTER	CAL Abt	
Exit 5	Turn the diverter valve to the sample position, arrow pointing left. Turn the calibration shut off valve to the measure position, arrow pointing up. Close the port on the flow cell cap. Press  .	TURN DIVERTER VALVE SO ARROW POINTS LEFT TURN SHUOFF VALVE UP CLOSE CAL PORT PRESS ENTER	FLO On	
Exit 6	No operator action needed. The system will enter the measure mode and remain on hold until the hold timer expires (default hold time is 30 minutes).	Actual temperature reading	Actual concentration reading	

Calibration Error Codes

At any point during a calibration, the appropriate error message will be displayed if there is a calibration related error.

The following table lists common calibration error codes with their marquee display and required operator actions.

Error	Operator Action	Scrolling Marquee	Main Display	Notes
Stability Time Out Error				
Error 41	Press  to continue the calibration despite the reading instability. or Press  to abort the calibration and refer to Exit 3. Repeat the calibration or refer to the troubleshooting section.	READINGS WERE UNSTABLE PRESS ENTER TO CONTINUE CALIBRATION OR PRESS EXIT TO ABORT SCREEN TO BACKUP	E041	The required system stability was not reached and a time out error occurred. Perform electrode cleaning, conditioning and troubleshooting.
Calibration Errors				
Error 42	Press  to abort the calibration and refer to Exit 3. Verify that the correct standards were used during the calibration, the standard values were entered correctly and in the right order and the electrodes are working properly and then repeat the calibration.	INVALID SLOPE PRESS ENTER	E042	The calculated slope was invalid. Standard values were likely entered in the wrong sequence or wrong standard values were entered.
Error 107	Press  to abort the calibration and refer to Exit 3.	CALIBRATION DATA TOO CLOSE TOGETHER PRESS ENTER	E107	Use new standards. Perform electrode cleaning, conditioning and troubleshooting.
Error 109	Press  to continue the calibration despite the bad slope. or Press  to abort the calibration and refer to Exit 3.	CH1 BAD SLOPE PRESS ENTER	E109	The calculated slope was outside of the recommended range. Perform electrode cleaning and conditioning, refer to the troubleshooting section and repeat the calibration.
Error 110	Press  to continue the calibration despite the bad slope. or Press  to abort the calibration and refer to Exit 3.	CH2 BAD SLOPE PRESS ENTER	E110	The calculated slope was outside of the recommended range. Perform electrode cleaning and conditioning, refer to the troubleshooting section and repeat the calibration.

Error	Operator Action	Scrolling Marquee	Main Display	Notes
Stability Time Out Error				
Error 125	Press  to abort the calibration and refer to Exit 3. Verify that the correct standards were used during the calibration, the standard values were entered correctly and in the right order and the electrodes are working properly and then repeat the calibration.	CH1 BAD OFFSET PRESS ENTER	E125	Use new standards. Perform electrode cleaning, conditioning and troubleshooting.
Error 126	Press  to abort the calibration and refer to Exit 3. Verify that the correct standards were used during the calibration, the standard values were entered correctly and in the right order and the electrodes are working properly and then repeat the calibration.	CH2 BAD OFFSET PRESS ENTER	E126	Use new buffers or standards. Perform electrode cleaning, conditioning and troubleshooting.

Calibration At Custom Concentrations Using DKA

The Thermo Scientific Orion 2111LL sodium analyzer software has default values to accommodate 0.1 mL additions of Thermo Scientific Orion standard 1 and standard 2 and a flow cell volume of 190 mL.

The operator has the option to use alternate standards by changing, in the setup mode, the flow cell volume, the standard 1 and standard 2 concentration values and the standard 1 and standard 2 volumes to be used.

Let	V_C	= Flow cell volume	Fixed: 190.0 mL
	C_1	= Standard 1 concentration	Default: 19.1 ppm
	C_2	= Standard 2 concentration	Default: 192 ppm
	V_1	= Volume of standard 1 added	Default: 0.1 mL
	V_2	= Volume of standard 2 added	Default: 0.1 mL
	dC_1	= Concentration change due to the first addition	
	dC_2	= Concentration change due to the second addition	
	dC_1	= $C_1 \times V_1 / (V_1 + V_C)$	
	dC_2	= $C_2 \times V_2 / (V_1 + V_2 + V_C)$	

For Maximum Accuracy:

- dC_1 should be at least twice the normal concentration in the sample
- dC_2 should be about ten times of dC_1 . dC_1 should not be less than 10 ppb

Span Check Procedure

The 2111LL sodium analyzer remains in the sample mode during this entire procedure.









1. The electrode must be etched within 2 to 3 hours of this procedure.
2. Fill the flow cell to the calibration level (V_0 , 190 mL).
3. Record the concentration that is displayed when the reading is reasonably stable (C_0).
4. Add standard 1, volume V_1 , with concentration C_1 .
5. When the reading is reasonably stable, record the concentration (C_S).
6. The recorded value should be within $\pm 10\%$ of the calculated value according to:















$$C_S = (C_0 \times V_0 + C_1 \times V_1) / (V_0 + V_1)$$









- C_1 should be the concentration actually in the standard bottle.

Offline Calibration Procedure

The offline calibration feature is simply a one point calibration without slope change. The term “offline calibration” refers only to the fact that a sample from 2111LL bypass is taken “offline” for laboratory analysis; in fact, no downtime is experienced and the analyzer remains online throughout the procedure.

Step	Operator Action	Scrolling Marquee	Main Display	Notes
1	Open the bypass/needle valve to redirect the sample flow.	Actual temperature reading	Actual concentration reading	
2	Press  to initiate the calibration.			HOLD and CAL appear as mode.
3	If the calibration password is active, enter the calibration password by pressing  /  to set the first digit,  to move to the next digit,  /  to set the values of the remaining digits and press  to move through the remaining digits Press  to accept the password.	ENTER PASSWORD	PASS ####	
4		CH1 or CH2 (flashing)	CAL CHnL	Displayed for two channel analyzer

















Step	Operator Action	Scrolling Marquee	Main Display	Notes
5	Press  /  to select the channel that will be calibrated and press  to begin the calibration.	CH1 or CH2 (flashing)	CAL CHnL	Action required for two channel analyzer
6		DKA, OFFL, or BLNK (flashing)	CAL tYPE	
7	Press  /  to select DKA and press  to accept the setting.	OFFL (flashing)	CAL tYPE	
8	Wait 1 to 10 minutes.	MEASURING SAMPLE WAIT 1 MINUTE AWAITING DATA STABILITY	Actual readings flashing	System continuously evaluates the data until a stable condition is met.
9	Take a QC sample from the 2111LL analyzer bypass for laboratory analysis. Press  .	TAKE SAMPLE FROM BYPASS DRAIN PRESS ENTER TO USE METER THEN PRESS CAL TO ENTER LAB RESULTS	Lab	
10	Perform laboratory analysis on QC sample and return with results.	Actual temperature reading	Actual concentration reading	System will return to measure mode and operate as normal. CAL and MEASURE appear as mode.
11	Press  to resume the calibration.			HOLD and CAL appear as mode.
12	If the calibration password is active, enter the calibration password as described in step 3. Press  to accept the password.	ENTER PASSWORD	PASS ###	
13		CH1 or CH2 (flashing)	CAL CHnL	Displayed for two channel analyzer
14	Press  /  to select the channel that will be calibrated and press  to begin the calibration.	CH1 or CH2 (flashing)	CAL CHnL	Action required for two channel analyzer
15	Press  /  to select OFFL and press  to accept the setting.	OFFL (flashing)	CAL tYPE	System circulates sample. Minutes will be counted down on the marquee.















Step	Operator Action	Scrolling Marquee	Main Display	Notes
16	<p>Enter the concentration value of the QC sample obtained from laboratory analysis:</p> <p>Press  to move the decimal point and set the value as ppm or ppb.</p> <p>Press  /  to set the first digit.</p> <p>Press  to move to the next digit.</p> <p>Press  /  to set the values of the remaining digits and press  to move through the remaining digits.</p> <p>Press  to save the value.</p>	<p>LAB ANALYSIS READY INPUT CONC VALUE FROM LAB PRESS ENTER TO CONTINUE OR PRESS EXIT TO ABORT</p>	<p>COnc ###.# (change flashing digit)</p>	
17		<p>NEW CALIBRATION E₀ PRESS ENTER TO ACCEPT OR PRESS EXIT TO ABORT</p>	<p>Actual E₀ value</p>	<p>The system will display the recalculated the E₀</p>
18	<p>Press .</p>			<p>The system will return to the measure mode. Only MEASURE should appear as mode.</p>

Blank Correction Procedure

The blank correction feature is simply a procedure used for very low (<1ppb) sample readings corrections. Blank correction adds an offset to the measurement and does not change the slope or E₀ value. The blank can be varied up to +/- 1ppb of the sodium reading to match alternate analysis values.

Step	Operator Action	Scrolling Marquee	Main Display	Notes
1	<p>Open the bypass/needle valve to redirect the sample flow.</p>	<p>Actual temperature reading</p>	<p>Actual concentration reading</p>	
2	<p>Press  to initiate the calibration.</p>			<p>HOLD and CAL appear as mode.</p>

Step	Operator Action	Scrolling Marquee	Main Display	Notes
3	<p>If the calibration password is active, enter the calibration password by pressing  /  to set the first digit,  to move to the next digit,  /  to set the values of the remaining digits and press  to move through the remaining digits.</p> <p>Press  to accept the password.</p>	ENTER PASSWORD	PASS ####	
4		CH1 or CH2 (flashing)	CAL CHnL	Displayed for two channel analyzer
5	<p>Press  /  to select the channel that will be calibrated and press  to begin the calibration.</p>	CH1 or CH2 (flashing)	CAL CHnL	Action required for two channel analyzer
6		DKA, OFFL, or BLNK (flashing)	CAL tYPE	
7	<p>Press  /  to select BLNK and press  to accept the setting.</p>	BLNK (flashing)	CAL tYPE	
8	Wait 1 to 10 minutes.	MEASURING SAMPLE WAIT 1 MINUTE AWAITING DATA STABILITY	Actual readings flashing	System continuously evaluates the data until a stable condition is met.
9	<p>Take a QC sample from the 2111LL analyzer bypass for laboratory analysis.</p> <p>Press .</p>	TAKE SAMPLE FROM BYPASS DRAIN PRESS ENTER TO USE METER THEN PRESS CAL TO ENTER LAB RESULTS	Lab	
10	Perform laboratory analysis on QC sample and return with results.	Actual temperature reading	Actual concentration reading	System will return to measure mode and operate as normal. CAL and MEASURE appear as mode.
11	Press  to resume the calibration.			HOLD and CAL appear as mode.
12	<p>If the calibration password is active, enter the calibration password as described in step 3.</p> <p>Press  to accept the password.</p>	ENTER PASSWORD	PASS ####	

Step	Operator Action	Scrolling Marquee	Main Display	Notes
13		CH1 or CH2 (flashing)	CAL CHnL	Displayed for two channel analyzer
14	Press  /  to select the channel that will be calibrated and press  to begin the calibration.	CH1 or CH2 (flashing)	CAL CHnL	Action required for two channel analyzer
15	Press  /  to select BLNK and press  to accept the setting.	BLNK (flashing)	CAL tYPE	System circulates sample. Minutes will be counted down on the marquee.
16	Enter the concentration value of the QC sample obtained from laboratory analysis: Press  to move the decimal point and set the value as ppm or ppb. Press  /  to set the first digit. Press  to move to the next digit. Press  /  to set the values of the remaining digits and press  to move through the remaining digits. Press  to save the value.	LAB ANALYSIS READY INPUT CONC VALUE FROM LAB PRESS ENTER TO CONTINUE OR PRESS EXIT TO ABORT	COnc ###.# (change flashing digit)	
17		NEW BLANK VALUE PRESS ENTER TO ACCEPT OR PRESS EXIT TO ABORT	Actual E _o value	The system will display the blank value
18	Press  .			The system will return to the measure mode. Only MEASURE should appear as mode.

5

SECTION 5 **Analyzer Maintenance**

Maintenance Schedule

The Thermo Scientific Orion 2111LL low level sodium analyzer is designed for simple maintenance. Follow the instructions in this section to ensure proper operation of your analyzer.

Recommendations

To ensure proper maintenance and good analyzer performance, a service logbook should be kept.

- Record the maintenance date and the type of service work completed.
- Mark the date and the fluid levels of the reagent and the date when it was replaced.
- Tag each electrode cable with the installation date of electrode.

Weekly Maintenance

1. Check that the sample flow rate is 35 to 45 mL/minute. To alter the flow rate, pull out the locking knob of the pressure regulator, and then rotate the black knob to increase (clockwise) or decrease (counterclockwise) sample flow. Push in the knob to lock the rate.
2. Inspect the analyzer for leakage. Diffusion tubing leakage is indicated by a rise in the level of reagent.
3. Check that there are no error indications and that the current concentration level is reasonable.
4. Check that the reference filling solution is adequate.
5. If required, wipe the analyzer with a damp cloth to remove dirt and dust particles.

Monthly Maintenance

WARNING: Safety glasses and gloves must be worn during the entire conditioning procedure. Read and follow the MSDS precautions. Only the sodium sensing electrode is etched. Do not etch the reference electrode.

Conditioning the Sodium Electrode

1. Immerse the sodium sensing electrode in the bottle of etch solution for one minute.
2. Remove the electrode and rinse it with deionized water.
3. Replace the electrode into the sensing port in the flow cell cap.

Calibration

Calibration frequency is operator dependent for the most accurate and precise measurements at low levels.

- Etching of the sodium electrode is required for effective calibration. Calibration must be completed within 2 to 3 hours of etching the electrode for optimal results.
- Replacement of the reagent requires calibration. Refer to **Section 4, Performing a DKA Calibration**.
- Calibration intervals can be programmed using the setup mode. This will prompt the operator to recalibrate after a specific amount of time has passed. Refer to **Section 3, Use of the Setup Mode**.

Replacement of the Reference Electrode Filling Solution

Refer to **Section 2, Installation of a New Reference Electrode**.

The reference electrode filling solution is meant to be a several month supply. Therefore, if the reservoir is less than one quarter full, replace the solution. This should be checked each month to ensure that the electrode does not run dry.

1. Remove the spent filling solution bottle from the clip. Unscrew the cap and discard the bottle.
2. Remove the cap and seal from a new reference electrode filling solution bottle. Check that the rubber gasket is properly aligned, and then connect the cap and tubing assembly to the bottle. The 1/8" tubing should extend into the bottle.
3. Invert the filling solution bottle and snap it into the clip.
4. Use the pushpin to puncture three air vents in the bottom of the bottle.

Replacement of the Sample Inlet Filter

1. If sample flow can be adjusted with the pressure regulator to 50 mL/minute or more, skip this procedure.
2. Turn off sample flow by turning the inlet valve to the right.
3. Remove the filter hex cap using a 1 inch open-ended wrench.
4. Separate the filter cap with bypass/needle valve assembly from the filter body, retaining the ring.
5. Remove the filter element and soft gasket (if necessary).
6. Replace the gasket and press a new sintered element into the filter body.
7. Replace the hex cap and bypass/needle valve assembly and reposition the bypass drain line into the drain assembly.
8. Retighten the hex cap to approximately 75 pound-inch in torque.
9. Turn on sample flow by turning the inlet valve left.
10. Check for leaks.

Replacement of the DIPA Reagent and Diffusion Tubing Assembly

WARNING: Replacement of DIPA reagent is dependent on operating conditions and usage. Replacement may occur as long as 60 days from installation. Be sure to monitor the DIPA levels weekly to assess the proper replacement schedule. DIPA is hazardous. Use protective glasses and gloves. Refer to the bottle label and MSDS for precautions. Work in a well-ventilated area.

DANGER: Turn off the air pump before beginning procedure; otherwise, the air pump will spatter caustic reagent outward as bottle is removed. Refer to **Section 3, Use of the Setup Mode** for instructions on how to turn the air pump on and off.

1. Remove the thumbnut and slide the reagent bottle and adaptor from the manifold assembly.
2. Unscrew the bottle cap and lift the adaptor from the bottle.
3. Remove the diffusion tubing assembly by unhooking the tubing from the hook, pulling off the two diffusion tubing caps and pulling the tubing off of the connectors, as shown in the figures below.

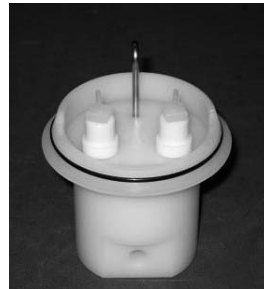
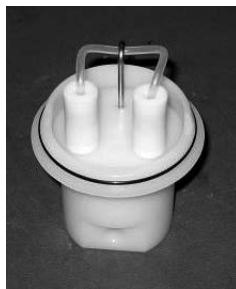

Note: Ensure the reagent bottle adapter connectors (2100RF) are finger tight to prevent possible leakage of sample into the reagent.

4. Press the diffusion tubing assembly onto the connector barbs, as shown in the figure below. The holes at the tubing ends press onto the barb fittings.



5. Press the diffusion tubing assembly caps onto the adaptors and loop the tubing onto the hook, as shown in the figure below.

Note: If using the 8 inch diffusion tubing, Cat. No. 211198, ensure that the tubing is above the DIPA reagent level. The 8 inch diffusion tubing may need to be looped twice onto the hook to keep the tubing above the liquid level.

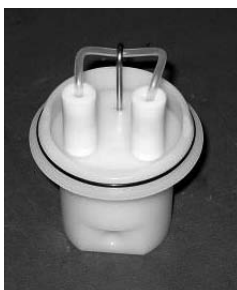

6. Properly dispose of the spent reagent and tubing.
7. Replace the reagent bottle cap adapter O-ring.
8. Follow the instructions in **Section 2, Installation of DIPA Reagent and Diffusion Tubing.**

Exploded View

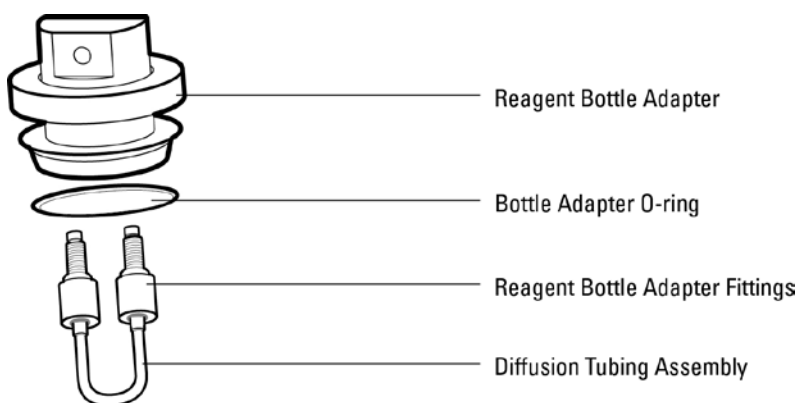

Notes on DIPA

DIPA reagent will last 2 months if the temperature is less than 25 °C. Higher temperatures will require bottle change out sooner, about 6 weeks. Generally, change reagents when the level is less than 1 inch remaining. The reagent bottle can be used almost to dryness, less than 50 mL remaining, if readings are not extremely low, less than 0.5 ppb. It is imperative that the bottle doesn't go completely dry or the system will be compromised.

Replacement of Reagent Manifold Face O-rings

Refer to the following figure for the replacement of reagent manifold face O-rings.

Reagent Manifold O-ring Location

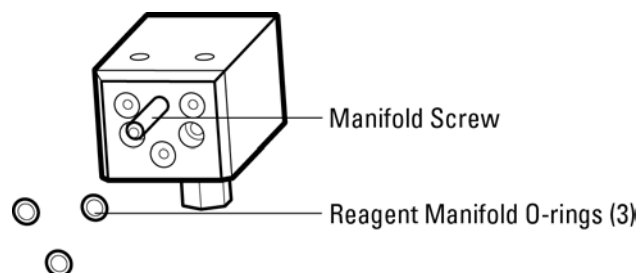

1. Remove the reagent bottle adapter assembly.
2. Remove all three O-rings from the face of the manifold.
3. Insert the new O-rings.

Yearly Preventive Maintenance

Electrodes

1. Replace the Thermo Scientific Orion reference electrode
2. (Cat. No. 210058). Refer to **Section 2, Installation of a New Reference Electrode** for step-by-step instructions.
3. Replace the Thermo Scientific Orion sensing electrode (Cat. No. 210048). Refer to **Section 2, Installation of a New Sodium Electrode** for step-by-step instructions.
4. Replace all of the calibration and etching solutions (Cat. No. 181140).

Dispose of all old solutions according to the MSDS instruction. The MSDS files can be downloaded at www.thermo.com/water.

Flow Cell

Use the flow cell O-ring kit from the annual maintenance kit (Cat. No. 2111MK). Refer to the following figure for O-ring location.

1. Follow the shut down procedure to stop sample flow to analyzer. Refer to **Section 3, Shutdown Procedure**.
2. Remove the electrodes and ATC probe from the flow cell cap.

3. Drain the flow cell completely.
4. Remove the flow cell cap. Replace the large O-ring in the flow cell cap.
5. Pull the flow cell chamber straight up to remove it from the flow cell base. Be careful not to twist it. The flow cell base has a pin to hold the flow cell chamber in the correct position.
6. Rinse the flow cell chamber with deionized water.
7. Remove the sensing tube by pulling it vertical from the flow cell base.
8. Replace the sensing tube O-ring in the base and install a new sensing tube to the original location.
9. Replace the large O-ring in the flow cell base.
10. Install the flow cell chamber. Line up the pinhole in the chamber to the pin in the flow cell block. Push it straight down. Do not twist it.
11. Replace the flow cell cap on the flow cell chamber.
12. Reinstall the electrodes and ATC probe in their port locations.
13. Follow the start-up procedure to return sample flow to the analyzer. Refer to **Section 3, Shutdown Procedure**.

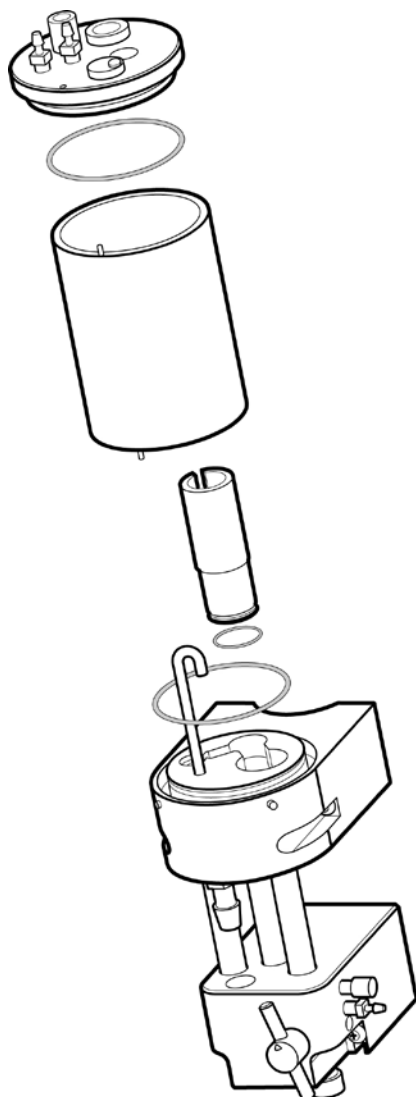

Flow Cell Assembly

Replacement of the Restrictor Tubing

Using the restrictor tube assembly (Cat. No. 2111RT) from the annual maintenance kit (Cat. No. 2111MK). Refer to the following figure for restrictor tubing connections.

1. Close the sample inlet valve to stop sample flow through analyzer by turning the valve to the right.
2. Loosen the restrictor tube fitting connection from the top of the calibration shut off valve.
3. Loosen the restrictor tube fitting from the reagent manifold.
4. Pull out the restrictor tube assembly at each end.
5. Unscrew the clip holding the restrictor to the panel.
6. Replace it with a new restrictor tubing assembly.
7. Be sure that all of the fittings are secure to prevent leaks.
8. Open the sample inlet valve to start sample flow through analyzer by turning the valve to the left.



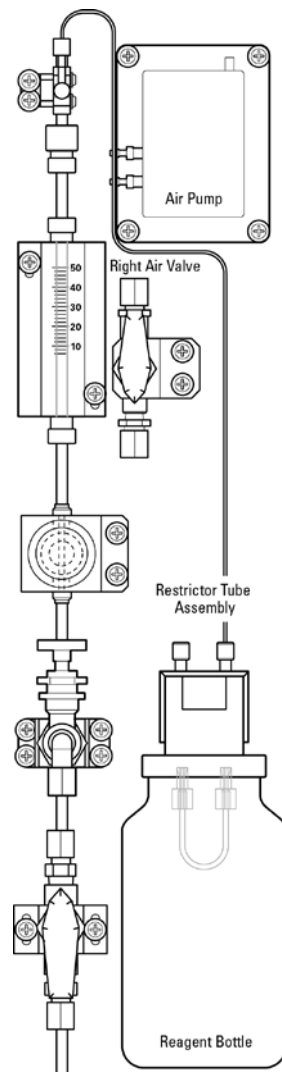

Restrictor Tubing





6

SECTION 6 Troubleshooting



Diagnostics Mode

- From the measure mode, press  to enter the diagnostics mode. The  key allows access to menus used for system diagnostics.
- Each menu is sequential. Press  to scroll through the diagnostics menu selections.
-  can be pressed at any time to return to the measure mode.







Default	Operator Action	Scrolling Marquee	Main Display	Notes
Diagnostics				
	<p>Press  while in the measure mode to enter the diagnostics mode.</p> <p>The system will enter the diagnostics mode at the calibration log menu.</p> <p>Press  to step through the menu items.</p>	CH1 CALIBRATION SLOPE AND E ₀ CH2 CALIBRATION CELL CONSTANT CH1 ERROR LIST PRESS VIEW CH2 ERROR LIST PRESS VIEW CH1 – SELECT TIME/DATE TO VIEW MEASUREMENT LOG CH2 – SELECT TIME/DATE TO VIEW MEASUREMENT LOG SELECT TIME/ DATE TO VIEW STATUS LOG SOFTWARE REV NUMBER CH1 SERIAL NUMBER CH2 SERIAL NUMBER CH1 MODEL NUMBER CH2 MODEL NUMBER CH1 MEASURE mV AND NOISE CH2 MEASURE mV AND NOISE	<p>The display will change with each menu</p>	<p>If only one board is installed in the analyzer, only one menu option will be shown in the scrolling marquee instead of CH1 and CH2 menu options.</p>

Default	Operator Action	Scrolling Marquee	Main Display	Notes
Diagnostics				
		CH1 mA OUTPUT VALUES SENSOR/TEMP CH2 mA OUTPUT VALUES SENSOR/TEMP PRESS ENTER FOR THE DISPLAY TEST PRESS ENTER TO CONTINUE PRESS ENTER TO CONTINUE KEYPAD TEST PRESS ALL KEYS ONE AT A TIME		



Calibration Log





- Displays up to the last twelve calibrations using three screens:
 1. Slope and E_0 (analyzers with a pH board or ISE board installed), mV offset (analyzers with an ORP board installed) or cell constant (analyzers with a conductivity board installed)
 2. Date and Time
 3. Temperature and Blank Correction
- Press  to scroll between the three information screens for each calibration
- Press  /  to view the last twelve calibrations

Default	Operator Action	Scrolling Marquee	Main Display	Notes
Calibration Log				
	Press  while in the measure mode to enter the diagnostics mode.			
		CALIBRATION SLOPE AND E_0	##.# (Slope) ##.# (E_0)	
		or _____		
		CALIBRATION OFFSET	###.# (mV offset)	
		or _____		
		CALIBRATION CELL CONSTANT	#.### (Cell Constant)	



Default	Operator Action	Scrolling Marquee	Main Display	Notes
Calibration Log				
	Press  to display the calibration time and date	CALIBRATION TIME/DATE	HH:MM MM/DD or DD/MM	Press  /  to scroll through the last 12 calibrations
	Press  to display the calibration temperature and electrode response	CALIBRATION TEMP AND BLANK CORRECTION	## . # c (Temperature) # . ## ppb (Blank)	Press  /  to scroll through the last 12 calibrations
	Press  to proceed to the next menu			





Error List

- Displays a list of system events, warnings, and error codes that cause the yellow or red LED to light.
- The top line of the main display shows the error code and the bottom line shows the number of error codes (1-5 indicates that one of five error codes is being displayed).
- Press  /  to scroll through the error list.
- Press  to display a description of each error code on the marquee.



Default	Operator Action	Scrolling Marquee	Main Display	Notes
Error List				
		ERROR LIST PRESS VIEW	E### # - #	
	Press  to display the description of the error code on the marquee	Actual description of error code	E### # - #	
	Press  /  to scroll through the error list	Actual description of error code	E### # - #	
	Press  to proceed to the next menu			

Measurement Log

- Displays logged measurements according to log interval entered in setup mode.
- Press  to toggle between the measurement value and the data and time.
- Press  /  to scroll through the log entries.



Default	Operator Action	Scrolling Marquee	Main Display	Notes
Measurement Log				
		SELECT TIME/DATE TO VIEW MEASUREMENT LOG	HH:MM MM/DD or DD/MM	
	Press  /  to scroll through the log entries	SELECT TIME/DATE TO VIEW MEASUREMENT LOG	HH:MM MM/DD or DD/MM	
	Press  to scroll between the measurement log and the data and time display	Actual temperature value for logged measurement	Concentration and mV values for logged measurement	
	Press  to proceed to the next menu			



Status Log

- Displays a list of system events.
- Press  /  to scroll through the log entries.
- Press  to toggle between the log code and the data and time.

Software Revision

- Displays the software revision numbers of the two processors.

Default	Operator Action	Scrolling Marquee	Main Display	Notes
Status Log				
		SELECT TIME/DATE TO VIEW STATUS LOG	HH:MM MM/DD or DD/MM	
	Press  /  to scroll through the log entries	SELECT TIME/DATE TO VIEW STATUS LOG	HH:MM MM/DD or DD/MM	

Default	Operator Action	Scrolling Marquee	Main Display	Notes
Status Log				
	Press  to toggle between the log code and the data and time	PRESS UP/DOWN KEY TO VIEW STATUS LOG	Event code	
	Press  to proceed to the next menu			
Software Revision				
		SOFTWARE REV NUMBER	r# . ## r# . ##	
	Press  to proceed to the next menu			

Electronics Serial Number

- Displays the serial number of the electronics assembly.

Model Number





- Displays the model number of the system.

mV and Noise Measurements





- Displays the current mV measurement value and the noise associated with the measurement.





mA Output Values

- Displays current mA values for sensor and temperature outputs.

Default	Operator Action	Scrolling Marquee	Main Display	Notes
Electronics Serial Number				
		SERIAL NUMBER	### ###	
	Press  to proceed to the next menu			
Model Number				
		MODEL NUMBER	#### ####	
	Press  to proceed to the next menu			
mV and Noise Measurements				
		MEASURE mV AND NOISE	Current mV measurement and noise	
	Press  to proceed to the next menu			
mA Output Values				
		mA OUTPUT VALUES SENSOR/TEMP	Current mA output values for sensor and temperature	
	Press  to proceed to the next menu			

Display Test

- Press  to start display test.
1. All the display segments will light up and the system will cycle through the LED colors.
 2. Verify that all the display segments are on and that the LED colors are functional and press .
 3. All the display segments will turn off except for the marquee display, which should show PRESS ENTER TO CONTINUE.
 4. Verify that all the display segments are off and press .
 5. The system will show a counting number pattern on both lines of the main display.
 6. Verify that the display segments are functional and press  to proceed to the keypad test.

Default	Operator Action	Scrolling Marquee	Main Display	Notes
Display Test				
		PRESS ENTER FOR THE DISPLAY TEST	dISP tEst	
	Press  to start the test			
	Verify that all of the display segments are on and that the LED colors are functional	All segments on	All segments on	System will cycle through the LED colors
	Press  to proceed to the next part of the test			
	Verify that all of the display segments are off	PRESS ENTER TO CONTINUE	All segments off	
	Press  to proceed to the next part of the test			
	Verify that all of the numeric display segments are functional	PRESS ENTER TO CONTINUE	Count pattern Count pattern	
	Press  to proceed to the next menu			

Keypad Test

- The main display will show 0 and the marquee will display KEYPAD TEST PRESS ALL KEYS ONE AT A TIME.
- Press all eight keys one at a time in any order.

*After the first key is pressed Error E033 will be displayed if a new key is not pressed within 10 seconds.

Default	Operator Action	Scrolling Marquee	Main Display	Notes
Keypad Test				
		KEYPAD TEST PRESS ALL KEYS ONE AT A TIME	0	
	Press all keys one at a time in any order	KEYPAD TEST PRESS ALL KEYS ONE AT A TIME	Display will show numbers 1 through 8 as keys are pressed	After the first key is pressed error E033 will be displayed if a new key is not pressed within 10 seconds
	No operator action needed The system will enter the measure mode if the keypad test is passed			

Slope Problems

Low Slope

Slope less than 44 mV/decade

- Check the electrode function, clean the electrode, recalibrate the analyzer, and if the analyzer continues to read low, replace the electrode.
- Check electronics to read mV input correctly. Use electronic test kit (Cat. No. 180029) procedure for checking electronics function.

Ion-selective electrodes (ISE) can be shown as DC-voltage sources with 50 to 1000 Megohm; a very high output impedance. ISEs respond to ion concentration changes with a voltage change of approximately 59 mV/decade for monovalent cations such as sodium. Knowing electrode and analyzers parameters like offset potential, slope, etc allows testing of various instruments by applying a known mV voltage.

Input Signal	Expected Reading: $\pm (0.5 \text{ mV} + 0.1\%)$
0 mV	- 0.5 mV to + 0.5 mV
- 1000 mV	-1001.5 mV to - 998.5 mV
+ 1000 mV	+ 998.5 mV to + 1001.5 mV

- Background concentration too high for the standards used.
- Standards contaminated or incorrectly made – verify calibration with fresh standards.
- Standard 1 and standard 2 interchanged – check the values on the standards and repeat the calibration. If using custom standards, verify the values for each standard.
- Standard 1 and standard 2 added in wrong sequence – check the sequence of the standards and repeat the calibration.
- pH adjustment is not correct – check the level and flow of the reagent. Replace the reagent if it is contaminated or the level is less than 50 mL. Refer to **Section 2, Installation of Reagent and Diffusion Tubing.**

High Slope

Slope greater than 63 mV/decade

- Improper calibration technique – refer to Chapter IV, Performing a DKA Calibration.
- Calibration standards contaminated – repeat the calibration using fresh standards.
- Electronics failure – reset the analyzer. Refer to Chapter VI, Resetting the Analyzer.
- Improper pipet technique – refer to the Appendix, Pipet Operation and Technique section.
- Background concentration too high for the standards used.
- Cables interchanged – verify wiring of cable connections to terminal strip. Refer to Chapter II, Wiring the Analyzer.
- Check the connection of the cable markers for the corresponding electrode. Cable markers are the white tape at the cap connector on the cable.
- “Ref” for the reference electrode
- “Sensing” for the sodium electrode
- Sensing electrode coated – clean or replace the sensing electrode.

Troubleshooting Matrix

Malfunction	Possible Cause	Remedy
Noisy	Blocked junction on reference electrode	Make sure electrolyte is flowing properly.
	Sodium or reference electrode failure	Check the cable connections and location of wiring to terminal strip. Refer to Section 2.
	Temperature probe failure	Disconnect ATC. Temperature should read 25 °C (E101). Replace if necessary.
	Air pump failure	Check the air flow for a steady stream of bubbles and replace if necessary.
	Calibration standard carryover	Disconnect the air pump intake tube. Rinse the flow cell and electrodes with deionized water by lifting the flow cell cap. Reconnect the air pump.
	Faulty electrode cables	Replace electrode cables.

Malfunction	Possible Cause	Remedy
Excessive Drift	Sample concentration varying	Check sample status. Perform a span check and if span check passes, the analyzer is okay.
	Blocked junction on reference electrode	Make sure the electrolyte is flowing properly and the bottle is vented.
	Sodium or reference electrode failure	Check the cable connections and location of wiring to terminal strip. Refer to Section 2 .
	Reference electrode filling solution empty or incorrect solution used	Use Cat. No. 211172 reference electrode filling solution.
	Diffusion tubing burst	Observe the liquid level in the reagent bottle. If the liquid level rises, replace the reagent and diffusion tubing. The tubing connector may need replacement. Refer to Section 2 .
	Temperature probe failure	Disconnect ATC. Temperature should read 25 °C (E101). Replace if necessary.
Low Flow Rate	Sample pressure below 8 psi	Check the sample pressure. If it is less than 8 psi, increase the pressure. Refer to Section 2 .
	Pressure regulator set too low	Increase the pressure by pulling on the red locking ring and turning the black knob clockwise. Refer to Section 2 .
	Inlet filter clogged	Replace or clean the filter.
	Restrictor tubing crimped or clogged	Replace the restrictor tubing. Refer to Section 2 .
No Air Bubbles	Air line crimped or disconnected	Check the air line and repair as required.
	Air pump failure	Replace if necessary.
Does Not Calibrate Properly	Contaminated standards, pipet or pipet tips	Use new standard solutions. Replace the pipet tips.
	Standards interchanged	Repeat calibration using standards in the correct sequence.
	Temperature probe failure	Disconnect ATC. Temperature should read 25 °C (E101). Replace if necessary.
	Background concentration too high for standards	Repeat calibration using custom, higher concentration standards. Refer to Section 4 .
	Pipet technique error	Use the correct pipet techniques. Refer to Section 8 .
	Reagent diluted or contaminated	Replace the reagent. Refer to Section 2 .
	Flow cell contaminated	Rinse the flow cell with deionized water. Flush the flow cell overnight at calibration liquid level. Refer to Section 4 .
Electronics failure or bad setup	Reset the analyzer. Refer to Section 6 .	
High Readings	Analyzer out of calibration	Recalibrate the analyzer. Refer to Section 4 .
	Flow cell contaminated	Rinse the flow cell with deionized water. Flush the flow cell overnight at calibration liquid level. Refer to Section 4 .

Malfunction	Possible Cause	Remedy
	Inlet filter just replaced	Flush the analyzer for one hour. Refer to Section 4 . If an offline calibration was performed, verify accuracy of alternate method value. Refer to Section 4 .
	Reagent spent or diluted	Replace the reagent. Refer to Section 2 .
Over-Range Readings	Electrode connections loose or bad	Verify the electrode connections to the electrode cables.
	Electrode wiring	Electrodes not properly wired to terminal strip. Refer to Section 2 .
	Blocked junction on reference electrode	Make sure electrolyte is flowing properly.
	Sodium or reference electrode failure	Electrode is shorted, cracked or damaged. Install a new electrode. Refer to Section 2 .
	Electronics failure or bad setup	Reset the analyzer. Refer to Section 6 .
	Analyzer out of calibration	Recalibrate the analyzer. Refer to Section 4 .
Low Readings	Analyzer out of calibration	Recalibrate the analyzer. Refer to Section 4 .
	Sample is very pure	Check sample status. Perform a span check and if span check passes, the analyzer is okay.
	Electronics failure	Try resetting the analyzer. Refer to Section 6 or consult Technical Support.
Default	Battery failure	Consult Technical Support.
	Electronics failure	Reset the analyzer. Refer to Section 6 .

Error/Event Codes

Error/event codes will be in the format “E###”. Some of these are errors, some are warnings, and some are purely informational. The first digits identify the type of error or event as identified in the table below.

Displayed Event Code	Description	Cause	Troubleshooting
System Status Codes			
A711	ALARM1 CH1 ON	Alarm 1 channel 1 engaged (closed)	
A712	ALARM2 CH1 ON	Alarm 2 channel 1 engaged (closed)	
A713	ALARM3 CH1 ON	Alarm 3 channel 1 engaged (open)	
A714	AIR PUMP ON	Air pump engaged	
A721	ALARM1 CH2 ON	Alarm 1 channel 2 engaged (closed)	
A722	ALARM2 CH2 ON	Alarm 2 channel 2 engaged (closed)	

Displayed Event Code	Description	Cause	Troubleshooting
System Status Codes			
A723	ALARM3 CH2 ON	Alarm 3 channel 2 engaged (open)	
A811	ALARM1 CH1 OFF	Alarm 1 channel 1 disengaged (open)	
A812	ALARM2 CH1 OFF	Alarm 2 channel 1 disengaged (open)	
A813	ALARM3 CH1 OFF	Alarm 3 channel 1 disengaged (closed)	
A814	AIR PUMP OFF	Air pump disengaged	
A821	ALARM1 CH2 OFF	Alarm 1 channel 2 disengaged (open)	
A822	ALARM2 CH2 OFF	Alarm 2 channel 2 disengaged (open)	
A823	ALARM3 CH2 OFF	Alarm 3 channel 2 disengaged (closed)	
C500	CAL MODE	Calibration mode entered	
R400	MEAS MODE	Measure mode entered	
S600	SETUP MODE	Setup mode entered	
E028	POWER FAIL	Brown out or power failure and system has stopped processing	Verify custom settings
E033	KEYPAD FAILURE	User did not press the keys during a diagnostic mode keypad test or keypad broken	Repeat diagnostic mode keypad test
E034	CAL PASS INCORRECT	User entered incorrect calibration password	Verify password
E035	SYSTEM PASS INCORRECT	User entered incorrect system password	Verify password
E036	USER VALUE INCORRECT	User entered a value that is out of range	Verify value and re-enter
E037	POWER RETURN	System started processing after brown out or power failure	Verify custom settings
E040	BLANK INCORRECT	Blank greater than 1 ppb	Verify scrolled blank value is correct and less than 1ppb. Repeat DKA if needed.
E041	CALIBRATION TIMEOUT	The electrode has not reach stability within the specified time	The system code may be due to out of range measurements or an invalid previous calibration
E042	INVALID SLOPE	Invalid slope obtained during calibration	Check electrodes, electrode cables and connectors for defects or shorts. Replace electrodes, if necessary. Recalibrate using new standards in the correct calibration sequence.

Displayed Event Code	Description	Cause	Troubleshooting
System Event/Error Codes - Yellow LED			
E004	DEFAULT VALUES	Analyzer has been reset or is new out of box	Calibrate the analyzer
E021	HARDWARE FAULT	System error	Contact Technical Support 1-800-225-1480
E101	CH1 TEMP OUT OF RANGE	Temperature sensor on channel 1 out of range (5 °C to 45 °C) for ISE	Check ATC cable and probe connections. Replace if needed.
E102	CH2 TEMP OUT OF RANGE	Temperature sensor on channel 2 out of range (5 °C to 45 °C) for ISE	Check ATC cable and probe connections. Replace if needed.
E111	CH1 CAL DUE	User calibration required on channel 1. No calibration has been performed in user specified time interval.	Recalibrate the analyzer.
E112	CH2 CAL DUE	User calibration required on channel 2. No calibration has been performed in user specified time interval.	Recalibrate the analyzer.
E127	CH1 SOUT mA OVER RANGE	Measured sensor value above Sout high limit value on channel 1	Verify user selectable Sout high limit value in setup mode
E128	CH1 SOUT mA UNDER RANGE	Measured sensor value below Sout low limit value on channel 1	Verify user selectable Sout low limit value in setup mode
E129	CH1 TOUT mA OVER RANGE	Measured temperature value above Tout high limit value on channel 1	Verify user selectable Tout high limit value in setup mode
E130	CH1 TOUT mA UNDER RANGE	Measured temperature value below Tout low limit value on channel 1	Verify user selectable Tout low limit value in setup mode
E131	CH2 SOUT mA OVER RANGE	Measured sensor value above Sout high limit value on channel 2	Verify user selectable Sout high limit value in setup mode
E132	CH2 SOUT mA UNDER RANGE	Measured sensor value below Sout low limit value on channel 2	Verify user selectable Sout low limit value in setup mode
E133	CH2 TOUT mA OVER RANGE	Measured temperature value above Tout high limit value on channel 2	Verify user selectable Tout high limit value in setup mode
E134	CH2 TOUT mA UNDER RANGE	Measured temperature value below Tout low limit value on channel 2	Verify user selectable Tout low limit value in setup mode

Displayed Event Code	Description	Cause	Troubleshooting
System Error Codes - Red LED			
E001	HARDWARE FAULT	System error	Contact Technical Support 1-800-225-1480
E002	HARDWARE FAULT	System error	Contact Technical Support 1-800-225-1480
E018	HARDWARE FAULT	System error	Contact Technical Support 1-800-225-1480
E019	HARDWARE FAULT	System error	Contact Technical Support 1-800-225-1480





Displayed Event Code	Description	Cause	Troubleshooting
System Error Codes - Red LED			
E020	HARDWARE FAULT	System error	Contact Technical Support 1-800-225-1480
E024	HARDWARE FAULT	System error	Contact Technical Support 1-800-225-1480
E026	HARDWARE FAULT	System error	Contact Technical Support 1-800-225-1480
E027	HARDWARE FAULT	System error	Contact Technical Support 1-800-225-1480
E029	HARDWARE FAULT	System error	Contact Technical Support 1-800-225-1480
E030	HARDWARE FAULT	System error	Contact Technical Support 1-800-225-1480
E038	HARDWARE FAULT	System error	Contact Technical Support 1-800-225-1480
E103	CH1 MEAS OVER RANGE	Measurement is over range on channel 1, the display should also be flashing '9999'	Check if electrode is not connected, electrode cables are faulty or electrode junction is fouled
E104	CH2 MEAS OVER RANGE	Measurement is over range on channel 2, the display should also be flashing '9999'	Check if electrode is not connected, electrode cables are faulty or electrode junction is fouled
E109	CH1 BAD SLOPE	Last calibration produced a bad slope on channel 1. Slope is less than 44 mV/decade or more than 63 mV/decade or the calibration standards may have been interchanged.	Recalibrate the analyzer using fresh standards. Recalibrate using the correct sequence of standards.
E110	CH2 BAD SLOPE	Last calibration produced a bad slope on channel 2. Slope is less than 44 mV/decade or more than 63 mV/decade or the calibration standards may have been interchanged.	Recalibrate the analyzer using fresh standards. Recalibrate using the correct sequence of standards.
E113	CH1 CAL OVERDUE	Calibration is overdue on channel 1 by more than 50% of the user specified time interval	Recalibrate the analyzer
E113	CH2 CAL OVERDUE	Calibration is overdue on channel 2 by more than 50% of the user specified time interval	Recalibrate the analyzer
E121	CH1 TEMP BROKEN	Temperature sensor on channel 1 broken or out of range	Check ATC cable connections and probe for damage. Replace if needed.
E122	CH2 TEMP BROKEN	Temperature sensor on channel 2 broken or out of range	Check ATC cable connections and probe for damage. Replace if needed.





Displayed Event Code	Description	Cause	Troubleshooting
System Error Codes - Red LED			
E125	CH1 BAD OFFSET	Last calibration produced a bad Eo offset on channel 1	Recalibrate the analyzer using fresh standards. Check electrode connections. Replace electrode, if needed.
E126	CH2 BAD OFFSET	Last calibration produced a bad Eo offset on channel 2	Recalibrate the analyzer using fresh standards. Check electrode connections. Replace electrode, if needed.

Resetting the Analyzer

The Thermo Scientific Orion 2111LL sodium analyzer allows the user to reset the analyzer through the setup mode or by a hard reset. Resetting the analyzer will restore all settings in the setup mode to factory default values.

WARNING: Resetting the analyzer will erase all data logs including calibration, and password protection settings for setup and calibration. The analyzer will reset setup parameters to factory default settings.

Operator Action	Scrolling Marquee	Main Display	Notes
Press  in the measure mode to enter the setup mode			
	Last menu used in setup mode	SEL SCm	SETUP appears as mode
Press  /  until RSET appears in the marquee			
	RSET (flashing)	SEL SCm	
Press  to reset the analyzer			
	PRESS TEST VIEW ENTER TO RESET	rSet ?	

Operator Action	Scrolling Marquee	Main Display	Notes
Press  Press  Press  When the reset is complete, the system will return to the measure mode. The operator will need to re-enter the setup mode to continue programming the setup parameters. Press  to return to the setup mode.	PRESS TEST VIEW ENTER TO RESET	rSEt ?	This command resets all previously set parameters to factory default values. Use this command only to set the analyzer to original factory setup values.

Hard Reset

A hard reset should be performed if the analyzer becomes unresponsive or the status indicators are flashing. Perform the following sequence:

- Carefully open the front cover of the electronics case (loosen the four corner screws).
- Press the small button located on the raised portion of the PCB to reset the electronics.
- Close the front cover of the electronics case and tighten the screws.

System settings and calibrations are preserved and analyzer returns to the measure mode. The actual value for concentration and temperature will be displayed if the electrodes are properly installed. If the system does not reset, contact Technical Support at 1-800-225-1480 for assistance.

Serial Number and Software Revision

In the event you require technical assistance, please have the serial number available when calling for assistance along with the software version.

- The analyzer serial number is located on the underside of the electronics enclosure or if panel mounted then on the backside of the electronics enclosure.
- The software revision is accessed through the diagnostics mode.

Service and Repair

Extended Warranty

The Thermo Scientific Orion 2111LL low level sodium analyzer provides measurements through a combination of our premium electrode technology and user friendly scrolling marquee to set a new industry standard for reliability. Similarly, Thermo Fisher Scientific now offers multiple levels of service programs to meet your needs beyond the One-Year Product Warranty period.

A cost effective way to blend your in-house expertise with our service and support experts, to get the support you need at a specified annual contracted price. This warranty plan must be purchased within ninety days of the initial product purchase date.

- Extends the features of the standard One-Year Product Warranty for a second or third year.
- Provides access to the manufacturer's technical experts at Thermo Scientific Orion Support Call Center, 1-800-225-1480, Monday through Friday, 8:00 AM to 5:00 PM EST.
- After telephone consultation, we will send you required parts for installation by your on-site technician.

Service Kit to Expand Standard Warranty

With in-house resources at a premium, many organizations require immediate access to manufacturer expertise. Purchase a service kit within ninety days of the initial product purchase date to eliminate the costly effects of down time.

- Provides a contracted, cost-effective means to enhance level of support offered during the product warranty period.
- Provides priority access to the manufacturer's technical experts at Thermo Scientific Orion Support Call Center.
- Provides a service kit to expedite on-site repairs in conjunction with telephone consultation with Thermo Scientific Orion product experts.

The service kit includes:

- Power supply
- Front panel display
- Air pump
- Electrode cables

Advanced Replacement

When down-time is a cost factor to be strictly controlled, the advanced replacement service plan is often times the best choice.

- Enhances level of support offered during the standard One-Year Product Warranty.
- Provides access to the manufacturer's technical experts at Thermo Scientific Orion Support Call Center and repair facilities.
- If, after reasonable remote diagnostics and trouble-shooting attempts, we determine the analyzer to be non-functioning, we will make all reasonable effort to get required parts or equipment out to your facility by the following day for installation by your on-site technician.
- Offers predictable expenditure through fixed annual contract price.

Not sure which plan is best for you?

Ask your Thermo Scientific Orion products sales representative to put you in touch with the service plan manager. We have additional service options that are sure to address your concerns.

Installation and Start-Up

To help you achieve optimum performance, rely on us to provide you with an efficient and quality installation and the start-up support you need to be up and running quickly. Our service representatives are highly trained, experienced, and certified for your product and will be there to make sure that your instrumentation delivers to specifications.

Remedial Service

This is a one-day service engineer on-site visit to your facility for remedial service events at standard response time. Consider this plan an excellent uplift to one of the aforementioned programs.

Preventive Maintenance Programs

All precision-made scientific equipment requires preventive maintenance and calibration checks to perform at their maximum effectiveness. Consider a fixed-fee preventive maintenance contract to have one of our experts perform the following tasks:

- Sampling check
- Full validation test
- Visual check for worn, loose or damaged parts
- Replacement of consumables (additional charge for consumables)
- Diagnostic check to verify all operating parameters are within the factory specifications
- Check analyzer electrodes, flows and pressures
- Clean and replace any wearable items

7

SECTION 7 **Customer Service**

Notice of Compliance

This equipment generates, uses and can radiate radio frequency energy and if not installed and used in accordance with the user guide, may cause interference to radio communications. It has been tested and found to comply with the limits for a Class A computing device pursuant to Subpart J of Part 15 of FCC Rules, which are designed to provide reasonable protection against such interference when operated in a commercial environment. Operation of this equipment in a residential area is likely to cause interference in which case the user, at his own expense, will be required to take whatever measure may be required to correct the interference.

“This digital apparatus does not exceed the (Class A) limits for radio noise emissions from digital apparatus set out in the Radio Interference Regulations of the Canadian Department of Communications.”

“Le présent appareil numérique n’émet pas de bruits radioélectriques dépassant les limites applicables aux appareils numériques (de la class A) prescrites dans le Règlement sur le brouillage radioélectrique édicté par le ministère des Communications du Canada.”

WEEE Compliance

This product is required to comply with the European Union's Waste Electrical & Electronic Equipment (WEEE) Directive 2002/96/EC. It is marked with the following symbol:



Thermo Fisher Scientific has contracted with one or more recycling/disposal companies in each EU Member State and this product should be disposed of or recycled through them. Further information on compliance with these directives, the recyclers in your country, and information on Thermo Scientific Orion products that may assist the detection of substances subject to the RoHS Directive are available at www.thermo.com/WEEERoHS.

Declaration of Conformity

Manufacturer: Thermo Fisher Scientific Inc.
Address: 22 Alpha Road
Chelmsford, MA 01824, USA

Hereby declares that the following products:

Model 2111LL Low Level Sodium Analyzer

Conforms with the following directives and standards:

Safety **Low Voltage Directive (LVD), 73/23/EEC**
EN61010-1:2001, Safety requirements for electrical equipment for measurement, control and laboratory use – general requirements

EMC **Electromagnetic Compatibility (EMC), 89/336/EEC**
EN 61326-1:2006, Electrical equipment for measurement, control and laboratory use

This product has been manufactured in compliance with the provisions of the relevant manufacturing and test documents and processes. These documents and processes are recognized as complying with ISO 9001:2008 by QMI, listed as File #001911.



Patrick Chiu
Senior Quality Engineer
Regulatory Compliance

Place and Date of Issue:
Beverly, MA
July 30, 2009

Terms and Conditions

For products not listed in this warranty statement, please visit our website at www.thermo.com/processwater.

Contact Information

For updated contact information, visit www.thermo.com/contactwater.

Thermo Fisher Scientific Inc.
22 Alpha Road
Chelmsford, MA 01824
Toll Free: 800-225-1480
Tel: 978-232-6000
Dom. Fax: 978-232-6015
Int'l Fax: 978-232-6031

Minimum Order

The minimum order requirement is \$100 for Thermo Scientific Orion process products. An order is considered to be a purchase order for products to be shipped to a single location. International minimum order requirements may vary. Contact your international coordinator for details.

Rush Orders

For customers in the U.S., rush orders received before 12 pm Eastern Time will be shipped the same day. Rush orders received after 12 noon Eastern Time will be shipped the next business day.

For customers and dealers in Canada, rush orders will be shipped within 2 business days. For customers and dealers outside the U.S. and Canada, contact your international coordinator for rush order scheduling. All rush orders carry a \$50 incremental charge per order. FOB: Beverly. Freight charges are prepaid and added or freight collect. All rush order processing is subject to stock availability.

Returning Goods

Permission to return Thermo Scientific Orion products must be obtained prior to return. Contact us within 30 days of receipt of goods for a return authorization number.

Hazardous Materials

Some materials are designated corrosive/oxidizer by DOT and IATA. Some materials may require special labeling and handling. Carriers may add additional freight charges for handling/transporting these materials. Consolidating such material with other products may be prohibited. Additional freight charges are billed to you per FOB terms. Advise manufacturer of shipping instructions for these hazardous materials to reduce your freight costs.

Restocking Charge

Permission to return new, excess inventory must be obtained prior to return. If any item is authorized to be returned for credit as a result of an incorrect purchase without a reorder, a 25% restocking charge of the price paid for the product will be made. International customer's restocking fee of 25% will be off the international price.

Only new (in the box) goods may be returned within 30 days of shipment from manufacturer. Older items, 9 digit parts and discontinued items cannot be returned for credit.

Short Shipments

Manufacturer must be notified within 30 days of receipt of invoice of any item or billing discrepancies. All substantiated claims will be remedied by a credit memo and a new order placed for short shipment. Any shipment discrepancy claimed after 30 days of invoice date will not be honored and credit will not be issued by manufacturer.

Force Majeure

Manufacturer shall not be liable for failure to perform or for delay in performance due to fire, flood, strike, or other labor difficulty, act of God, act of any governmental authority or of the purchaser, riot, embargo, fuel or energy shortage, wrecks or delays in transportation, inability to obtain necessary labor, materials, or manufacturing facilities from usual sources, or due to any cause beyond its reasonable control. In the event of a delay in performance due to any such cause, the date of delivery or time for completion of performance will be extended by a period of time reasonably necessary to overcome the effect of such delay.

Warranty

Thermo Scientific Orion process products are warranted to be free from defects in material and workmanship for a period of 12 months from date of installation or 18 months from date of shipment, whichever is earlier, when used under normal operating conditions and in accordance with the operating limitations and maintenance procedures given in the user guide and when not having been subjected to accident, alteration, misuse or abuse. This warranty is also conditioned upon expendable and consumable items (diffusion tubing, electrodes and all solutions) being stored at temperatures between 5 °C and 45 °C (40 °F and 110 °F) in a non-corrosive atmosphere and within the shelf life printed on the product.

In the event of failure within the warranty period, the manufacturer or its authorized dealer will, at the option of manufacturer, repair or replace the product nonconforming to the above warranty or will refund the purchase price of the product.

The warranty described is exclusive and in lieu of all other warranties whether statutory, express, or implied including, but not limited to, any implied warranty of merchantability or fitness for a particular purpose and all warranties arising from the course of dealing or usage of

trade. The buyer's sole and exclusive remedy is for repair or replacement of the non-conforming part thereof, or refund of the purchase price, but in no event shall the manufacturer (its contractors and suppliers of any tier) be liable to the buyer or any person for any special indirect, incidental, or consequential damages whether the claims are used in contract, in tort (including negligence), or otherwise with respect to or arising out of the product furnished hereunder.

Process products used at overseas nuclear facilities are also subject to the manufacturer's nuclear terms and conditions. Contact the manufacturer if you do not have a copy.

Representations and warranties made by any person, including its authorized dealers, distributors, representatives, and employees of the manufacturer, which are inconsistent or in addition to the terms of this warranty shall not be binding upon manufacturer unless in writing and signed by one of its officers.

8

SECTION 8 Appendix

Mounting Dimensions

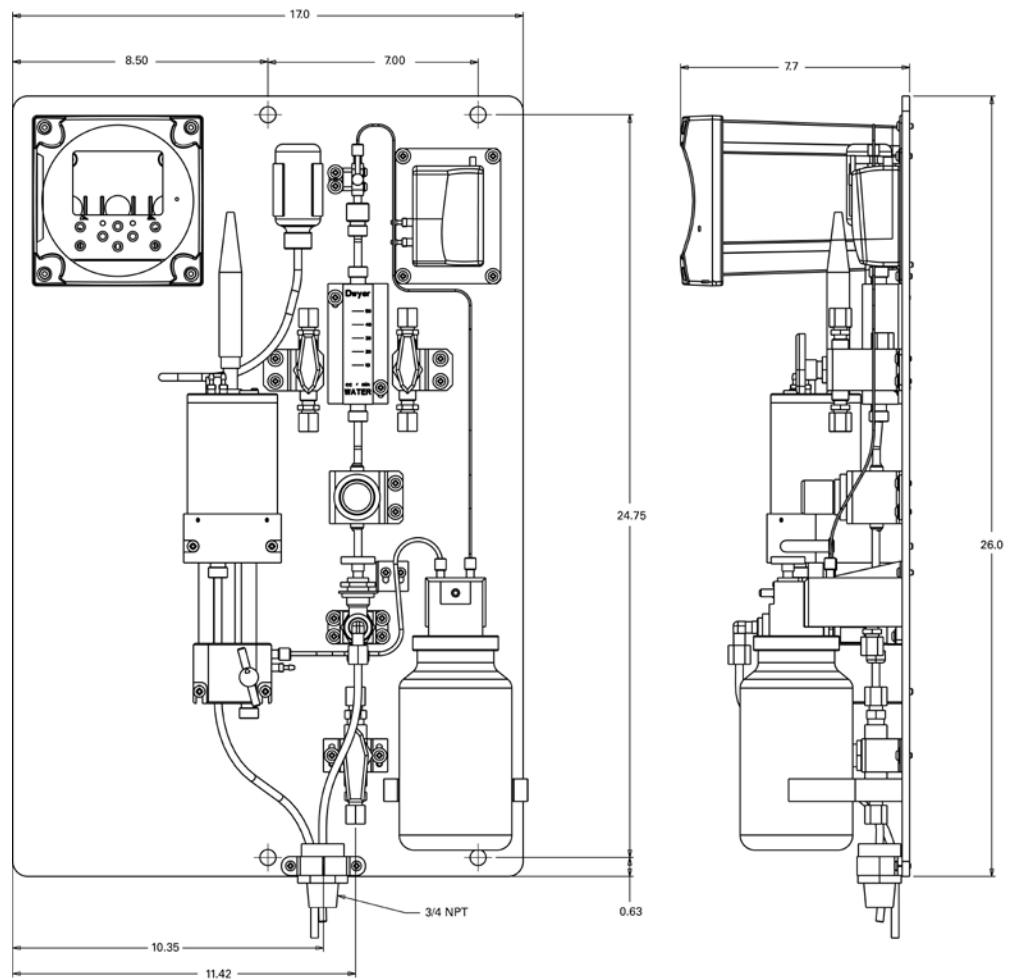

ISE Default Values

E_0 default: - 70.0 mV

Low limit of E_0 : - 130 mV

High limit of E_0 : - 10 mV

Slope default: 59.15 mV/decade

Slope range: 45.0 mV/decade to 62.0 mV/decade

C_{ISO} : 115 ppm = 115000 ppb

Volume of flow cell (fixed): 190 mL

Concentration of standard 1 added during calibration = 19.1 ppm

Volume of standard 1 added during calibration = 0.1 mL

Concentration of standard 2 added during calibration = 192 ppm

Volume of standard 2 added during calibration = 0.1 mL

Specifications

Sodium ISE	
Range	0.001 ppb to 10 ppm
Resolution	2, 3 or 4 significant digits
Accuracy (with DKA calibration)	± 5% or 0.01 ppb, whichever is greater. Accuracy not guaranteed above 10 ppm.
Accuracy (with DKA calibration and offline calibration)	± 2.5% or 0.01 ppb, whichever is greater (assuming "true" value from the reference)
Precision	± 2.5% or 0.01 ppb, whichever is greater
Response Time	90% within 5 minutes after calibration with freshly etched sodium sensing electrode <ul style="list-style-type: none"> • Reach 90% of final reading within 5 minutes of injecting a standard solution or • 5 minutes, maximum for time from 5% to 90% of measured change following dynamic addition of a standard solution
Units Displayed	ppb, ppm
Temperature Compensation	Automatic
Range	± 1999.9 mV
Resolution	0.1 mV
Relative Accuracy	± (0.5 mV + 0.1%)

Temperature Measurement	
Range	-10 to 120 °C
Resolution	0.1 °C
Relative Accuracy	± 0.5 °C
Failure Detection	Manual compensation
ATC Probe	30 K thermistor
LED Status Indicator	
Green	OK
Yellow	Warning
Red	Failure
Sample Conditions	
Temperature	5 to 45 °C
Total Alkalinity	Less than 50 ppm CaCO ₃
Inlet Pressure	8 to 100 psig
Flow Rate	40 mL/minute nominal set by pressure regulator 1/4" NPTF tube fitting
Sample Drain	3/4" NPT male
Grab Sampler	Optional
Reagent	Diisopropylamine
Display Features	
Type	Backlit custom LCD
Size	54 x 76 mm (2 1/8 in x 3 in)
Marquee	Temperature, operator prompts
Middle Line	Concentration, error codes
Lower Line	mV (selectable)
Text Display	Scrolling marquee for English language instructions for setup, calibration and diagnostics
Calibration	
DKA Calibration	Yes
DKA Calibration Points	3 points
Off-line Calibration	Yes
Off-line Calibration Points	1 point
Pre-programmed Standard Values	Yes
Custom Calibration	Programmable for concentration and volume
Operator Input	DKA, customer programmable, off-line and blank correction
Keypad	8 keys with graphic overlay

Inputs (Potentiometric)	
Sodium Ion Input	ROSS sodium
Sodium Ion Reference	ROSS Ultra reference
Outputs	
Number of Analog Outputs	2 (shared ground)
Galvanically Isolated	Yes
Output Selections	0 to 20 mA, 4 to 20 mA
Programmable Range	Yes
Channel Assignments	Sodium and temperature
Relative Accuracy	$\pm (0.05 \text{ mA} + 0.5\%)$
Maximum Load	500 ohm or 10 V
Log and Linear Output Options	Yes, operator selectable
Alarm Outputs	
Number of Relay Outputs	3
Maximum Relay Load	250 VAC/5 A, 30 VDC/5 A, resistive load only
Minimum Value Alarm	Yes
Maximum Value Alarm	Yes
Error Alarm	Yes
Offline/calibration Alarm	Yes
Programmable Min. and Max. Values	Yes
Analyzer Features	
Non-volatile Memory	Yes
Battery Backup (replaceable)	Yes
Data Logging	Yes
Software Features	
Self Test and Diagnostics	Yes
Real Time Clock	Yes
Programmable Alarms	High, low, error, calibration/offline
Reset Function	Yes
Measurement, Active	Signal noise, temperature
Calibration	Sensor response, drift, E_0 , slope, temperature

Miscellaneous	
Graphics	Custom chemical resistant
Cleaning Instructions	Wipe with damp cloth
Case Color	Black
Case Material	Valox 364
Warranty	12 months from date of installation or 18 months from date of shipment, whichever is earlier
Service Policy	Field service and factory
User Guide	CD/printed/web
Regulatory and Safety	CE, CSA, FCC class A limits
Physical Size of Analyzer	65 x 45 x 27 cm (26 x 17 x 11 in) Fits on 1811EL panel mounting footprint Weight: 22.7 kg (50 lbs)
Physical Size of Electronics Module	Size (mm): 144 x 144 x 187 (in): 5.67 x 5.67 x 7.36 Weight (kg): 1.7 (lbs): 3.75
Power Input	85 to 132 V; 200 mA or 170 to 264 V; 100 mA 50 to 60 Hz AC
Over Voltage Category	II
Environmental Operating Conditions	
Waterproof Enclosure	IP66 and NEMA 4X
Overvoltage Category	II
Ambient Temperature	5 to 45 °C
Relative Humidity	Up to 95% non-condensing
Pollution Degree	2
Storage Temperature	-20 to 60 °C
Storage Humidity	Up to 95%, non-condensing
Altitude	Sea level to 2000 M
Shock and Vibration	
Vibration, Shipping/handling	0 to 60 Hz @ 1 G Load
Shock, Drop Test in Packaging	36" on all sides and corners

Ordering Information

Cat. No.	Description
2111LL	Low Level Sodium Analyzer Only Package – includes low level sodium analyzer with ROSS sodium electrode (210048), ROSS Ultra reference electrode (210058), ATC probe (2100TP), sodium standard solutions kit (181140), CD user guide and options kit
2111LLG	Low Level Sodium Analyzer Only Package– includes low level sodium analyzer and integral grab sampler, ROSS sodium electrode (210048), ROSS Ultra reference electrode (210058), ATC probe (2100TP), standard solutions kit (181140), CD user guide and options kit
2111LLEN	Low Level Sodium Analyzer Protective Enclosure Package – includes low level sodium analyzer with enclosure, ROSS sodium electrode (210048), ROSS Ultra reference electrode (210058), ATC probe (2100TP), sodium standard solutions kit (181140), CD user guide and options kit
2111LLENG	Low Level Sodium Analyzer With Protective Enclosure Package– includes low level sodium analyzer with protective enclosure and integral grab sampler, ROSS sodium electrode (210048), ROSS Ultra reference electrode (210058), ATC probe (2100TP), standard solutions kit (181140), CD user guide and options kit
2111FP	Low level sodium analyzer, fluidics only
211100	Low level sodium analyzer, electronics only
181148	Calibration kit with carrying case, 0.1 mL pipet, box of pipet tips, wash bottle, (1) x 2 oz bottle of standard 1 (19.1 ppm sodium), (1) x 2 oz bottle of standard 2 (192 ppm sodium) and (1) x 2 oz bottle of etch solution
181140	Sodium standard solution kit with (2) x 2 oz bottles of standard 1 (19.1 ppm sodium), (2) x 2 oz bottles of standard 2 (192 ppm sodium) and (1) x 2 oz bottle of etch solution (181113)
181141	High level sodium standard solution kit with (2) x 2 oz bottles of standard 1 (1910 ppm sodium), (2) x 2 oz bottles of standard 2 (19200 ppm sodium) and (1) x 2 oz bottle of etch solution
181113	Sodium electrode etch solution, (1) x 2 oz. bottle
210048	ROSS sodium electrode with screw cap
210058	ROSS Ultra reference electrode with screw cap
211172	(5) x 2 oz bottles of ROSS reference electrode filling solution
2111EK	Electrode kit with (1) ROSS sodium electrode (210048) and (1) ROSS Ultra reference electrode (210058)
21003M	(2) x 3 meter extension cables for 210048 and 210058 electrodes
2100TP	Automatic temperature compensation probe with ground (30 k Ω)
2001XT	Automatic temperature compensation probe with 10 meter extension cable and ground (30 k Ω)
211192	Sodium consumables kit for one year operation, includes (6) x 0.8 L bottles of DIPA reagent with 6 diffusion tubing kits (211194), reagent bottle adapter (2100DRBA), sodium standard solutions kit (181140), sodium electrode (210048), reference electrode (210058), (5) x 2 oz bottles of reference filling solution, O-ring kit, check valve, 1 set of 100 pipet tips, restriction tube assembly, (2) x 60 micron inlet filters and filter gasket
211190	Diisopropylamine (DIPA) reagent for 60 day operation, includes 1 x 0.8 L bottle of DIPA reagent and diffusion tubing assembly
211190FOR	Reagent-less Diisopropylamine Reagent - (1) x 0.8 L empty bottle for use with DIPA reagent and (1) diffusion tubing kit (211194)

Cat. No.	Description
211191	Diisopropylamine (DIPA) reagent for one year operation, includes 6 x 0.8 L bottles of DIPA reagent and (6) diffusion tubing assemblies
211191FOR	Reagent-less Diisopropylamine Reagent - (6) x 0.8 L empty bottles for use with DIPA reagent and (6) diffusion tubing kits (211194)
211194	Diffusion tubing assembly for DIPA reagent, 4 inch tubing with O-rings
211198	Diffusion tubing assembly for DIPA reagent, 8 inch tubing with O-rings

Accessory Options

Cat. No.	Description
2100EN	Protective enclosure for use with the 2111LL sodium analyzer
180029	Electronic test kit for troubleshooting 2100 series analyzers
2100PH2	Second channel module for pH/ORP
2100CD2	Second channel module for conductivity
21GRABLL	Low level sodium grab sampler / FAST QC upgrade module to fit existing 2111LL and 2111LLEN analyzers
21GRBT	Replacement bottle for 2100 series grab sampler
21GRPA	Air pump replacement kit for 2100 series grab sampler
21GRFK	Fittings kit for 2100 series grab sampler
180300	Steam sample conditioner for high-pressure steam samples for use with 1800/2100 series analyzers
15DC15	Dynamic calibrator, 115 V, includes syringe pump, syringe kits (Cat. No. 150096 and 180096) and mounting bracket
15DC20	Dynamic calibrator, 230 V, includes syringe pump, syringe kits (Cat. No. 150096 and 180096) and mounting bracket
216970-A01	Low level verification kit, includes T-fittings and tubing for use with dynamic calibrator systems (Cat. No. 15DC15 and 15DC20)

Field Replaceable Parts

Cat. No.	Description
2100EN	2100 series enclosure for use with the 2111LL sodium analyzer
2111FP	Fluidics panel assembly
2100BP	Steel back panel assembly
2111LEP	2111LL electronics faceplate
2100NV	Inlet valve assembly
2100BV	Needle valve assembly
2111RG	Regulator assembly
2111FM	Flow meter assembly
2111SV	Calibration shut off valve assembly
2111RT	Restrictor tube assembly
2111RF	Reagent Bottle Adapter Fittings
2111RMA	Reagent manifold assembly

Cat. No.	Description
2100DRBA	Reagent bottle adapter assembly
2111DBB	Reagent bottle bracket for DIPA reagent bottle
2111NT	Inlet tube assembly
2111PA	Air pump assembly
2111RVA	Right air valve
2111LVA	Left air valve
2100AF	Air filter
2111VC	Check valve
2100TG	Tygon tubing (4 feet)
2100PS	Power supply assembly
2100FK115	Fuse kit assembly, 115 V
2100FK230	Fuse kit assembly, 230 V
2111FC	Flow cell assembly (complete)
2111CA	Flow cell cap assembly
2111LLOK	O-ring kit for 2111LL
2111ST	Sensing tube for flow cell
2111DV	Diverter valve
181170	2 Inlet sample filters
2111EC	(2) x 1 meter electrode cables for 210048 and 210058 electrodes
2111MK	Maintenance kit, includes (2) electrode cables, (1) diffusion tubing kit, (1) sample filter, (1) O-ring kit, (1) check valve, (1) sensing tube, (1) shut off valve, (1) restrictor tubing assembly, (1) air filter, (1) inlet tubing assembly and (1) reagent bottle cap and adapter
2111LLSK	Service kit, includes (1) electronics faceplate (2111LLEP), (1) air pump assembly (2111PA), (1) regulator assembly (2111RG), (2) electrode cable assemblies for 210048 and 210058 electrodes, (1) power supply assembly (2100PS) and (1) fuse kit assembly (2100FK115 and 2100FK230)

Recommended Consumables for Annual Operation

Cat. No.	Description	Quantity
211192	Sodium consumables kit for one year operation, includes (6) x 0.8 L bottles of DIPA reagent with 6 diffusion tubing kits (211194), reagent bottle adapter (2100DRBA), sodium standard solutions kit (181140), sodium electrode (210048), reference electrode (210058), (5) x 2 oz bottles of reference filling solution, O-ring kit, check valve, 1 set of 100 pipet tips, restriction tube assembly, (2) x 60 micron inlet filters and filter gasket	1
181148	Calibration kit with carrying case, 0.1 mL pipet, box of pipet tips, wash bottle, (1) x 2 oz bottle of standard 1 (19.1 ppm sodium), (1) x 2 oz bottle of standard 2 (192 ppm sodium) and (1) x 2 oz bottle of etch solution	1

Recommended Field Replaceable Spare Parts

Cat. No.	Description	Quantity
2111RG	Regulator assembly	1
2111PA	Air pump assembly	1
2111FM	Flow meter assembly	1
2111EK	Electrode kit with (1) 210048 sodium electrode and (1) 210058 reference electrode	1
2111MK	Maintenance kit, includes (2) electrode cables, (1) diffusion tubing kit, (1) sample filter, (1) O-ring kit, (1) check valve, (1) sensing tube, (1) shut off valve, (1) restrictor tubing assembly, (1) air filter, (1) inlet tubing assembly and (1) reagent bottle cap and adapter	1 per unit
2111LLSK	Service kit, includes (1) electronics faceplate (2111LLEP), (1) air pump assembly (2111PA), (1) regulator assembly (2111RG), (2) electrode cable assemblies for 210048 and 210058 electrodes, (1) power supply assembly (2100PS) and (1) fuse kit assembly (2100FK115 and 2100FK230)	1 per unit

Pipet Operation

Tip Ejection

To help eliminate the risk of contamination, each pipet is fitted with a tip ejector system. The tip ejector system consists of a soft-touch tip ejector and specially designed gearing mechanism. To release the tip, point the pipet at suitable waste receptacle and press the tip ejector with your thumb.

You can attach the pipet shelf hanger on a counter, pipet stand or anywhere where you want to hang your pipet.

Clean the area where you plan to attach the shelf hanger. Apply two stickers to the underside of the shelf hanger. Press the shelf hanger firmly into place on a shelf, counter top or pipet stand. To use, hang the grippy finger rest on the shelf hanger.

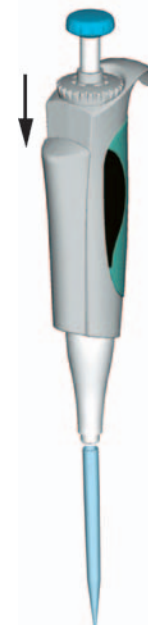

Pipet Techniques

General

Special care should be taken to avoid liquid being aspirated into the interior working of the pipet. Push and release the push button slowly at all times, particularly when working with high viscosity liquids. Never allow the push button to snap back. Make sure that the tip is firmly attached to the tip cone. Check for foreign particles in the tip.

- Do not touch pipet tip with bare fingers. Risk of contamination is possible. Use powder free gloves for protection.

Before you begin your actual pipeting work, fill and empty the tip 3 to 5 times with the solution that you will be pipeting. Hold the pipet in an upright position while aspirating liquid. The grippy should rest on your index finger. Make sure that the tips, pipet and solution are at the same temperature.

Forward Technique

Fill a clean reagent reservoir with the liquid to be dispensed.

1. Depress the push button to the first stop.
2. Dip the tip under the surface of the liquid in the reservoir to a depth of about 1 cm and slowly release the push button. Withdraw the tip from the liquid, touching it against the edge of the reservoir to remove excess liquid.
3. Deliver the liquid by gently depressing the push button to the first stop. After a delay of about one second, continue to depress the push button all the way to the second stop. This action will empty the tip.
4. Release the push button to the ready position. If necessary, change the tip and continue pipeting.

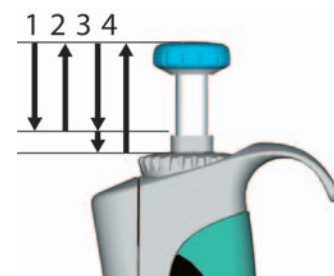



*Thermo Fisher Scientific
Water Analysis Instruments
Chelmsford, MA USA
Quality Management System
Registered to ISO 9001*

thermoscientific.com/processwater

© 2013 Thermo Fisher Scientific Inc. All rights reserved. Modbus is a registered trademark of Schneider Electric. Kimwipes is a registered trademark of Kimberly-Clark and its affiliates. Certified System StandardsMark logo is a trademark of SAI Global. All other trademarks are the property of Thermo Fisher Scientific Inc. & its subsidiaries.

Water Analysis Instruments

North America

Toll Free: 1-800-225-1480
Tel: 1-978-232-6000

Netherlands

Tel: (31) 020-4936270
info.water.uk@thermo.com

China

Tel: (86) 21-68654588
wai.asia@thermofisher.com

India

Tel: (91) 22-4157-8800
wai.asia@thermofisher.com

Singapore

Tel: (65) 6778-6876
wai.asia@thermofisher.com

Japan

Tel: (81) 045-453-9175
wai.asia@thermofisher.com

Australia

Tel: (613) 9757-4300
in Australia (1300) 735-295
InfoWaterAU@thermofisher.com

Thermo
SCIENTIFIC

Part of Thermo Fisher Scientific