

# HIGH-SPEED REFRIGERATED CENTRIFUGES

---

## CR22N/CR21N

---

Thank you for purchasing the high-speed refrigerated centrifuge. Before using this centrifuge, carefully read through this instruction manual to ensure efficient and safe operation. Keep this instruction manual handy.

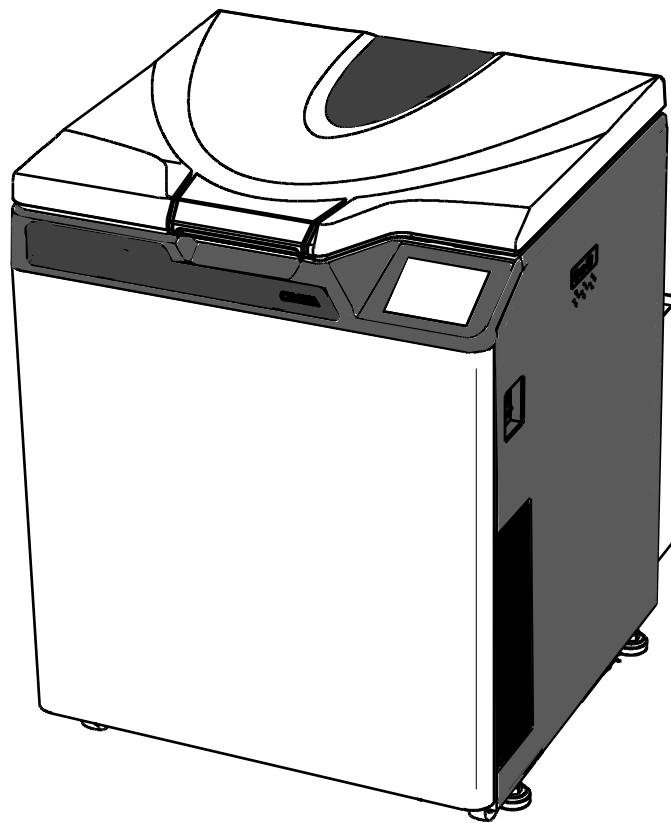

- The appearance or specification of the products covered in this manual is subject to partial change for improvement.





---

 **SAFETY NOTICES**

---

 **Safety reminders**

The centrifuge is designed to separate liquid-suspended materials having different densities and particle size.

Carefully read and fully understand the following safety instructions.

- Operate your instrument according to the instruction manual.
- Be sure to observe the all safety precautions in the instruction manual and safety instructions on your instrument. If neglected, personal injury and/or instrument damage can be caused.
- If the equipment is used in a manner not specified by the manufacturer, the protection provided by the equipment may be impaired.
- The safety reminders are indicated as shown below. The signal words "DANGER", "WARNING" and "CAUTION" are indicated together with the hazard alert symbols in this manual.

 **DANGER** : This note indicates an imminently hazardous situation, which if not strictly observed, could result in personal severe injury or possible death.

 **WARNING** : This note indicates a potentially hazardous situation, which if not strictly observed, could result in personal severe injury or possible death.

 **CAUTION** : This note indicates a potentially hazardous situation, which if not strictly observed, could result in personal injury or severe damage to the instrument.

This hazard alert symbol indicated together with a signal word is a reminder to emphasize important safety instructions.

"NOTE" indicates a note which has no direct bearing on personal safety.

- Do not perform any operation not specified in the instruction manual. If any problem is found on your instrument, contact an authorized sales or service representative.
- Although the safety precautions in the instruction manual and safety instructions on your instrument have been fully considered, an unexpected situation may arise. Observe the instructions in the instruction manual and always be careful yourself when operating this instrument.



## SAFETY NOTICES

---

### OMechanical Safety

-  **WARNING:**
- For operator safety, maintain a 30-cm "clearance envelope" around the instrument while the rotor is spinning. Do not store dangerous substances capable of developing flammable or explosive vapors on nor near the centrifuge.
  - Do not attempt to unlock the door forcefully while the rotor is spinning.
  - Do not attempt to slow or stop the spinning rotor by hand.
  - Check the chemical resistance chart provided with the rotor, and do not use any sample inapplicable to the rotor (including the buckets). Using such a sample could corrode the rotor (including the buckets).
  - Do not incline or move the instrument while the rotor is spinning. Do not lean on the instrument.
  - Do not exceed the maximum rated speed of the rotor or buckets in use.
  - Do not use corroded, scratched or cracked rotor, buckets and assemblies. Check that the rotor, buckets and assemblies are free of such abnormalities before operation.
  - When using a swing rotor, check that the buckets are properly engaged with the rotor pins before operation. Wrong setting can cause severe damage to the instrument. Be sure to set all the buckets of the same serial number.
  - When pressing the **[START]** button after closing the centrifuge door, the door is locked and the operation starts. When the door is locked, you can hear the beep sound from the centrifuge. When the door is locked, do not catch your fingers and objects in the space between the centrifuge door and the centrifuge table. Failure to do so can cause your fingers to be injured and failure to do so can cause the centrifuge to be damaged.
  - If abnormal sound or vibration occurs, stop the operation immediately and contact an authorized sales or service representative.

-  **CAUTION:**
- Before using a rotor, be sure to read through the rotor instruction manual.
  - Check the chemical resistance chart attached to the rotor, and do not use any sample inapplicable to the tubes, the bottles, the tube racks, the microplates or tube / bottle caps, etc. Using such a sample could deteriorate such parts.
  - Maximum rotor speed depends on the buckets, assemblies, tubes or adapters to be used. Follow the instructions on the rotor instruction manual.
  - Do not exceed the allowable imbalance.
  - Use the rotor tubes and bottles within their actual capacities.
  - Do not use tubes/bottles that have exceeded their life expectancy. Failure to do so could result in damage of tubes/bottles and the rotor and the centrifuge. The life expectancy of tubes/bottles depends on factors such as the characteristics of samples, speed of the rotor used, and temperature. Always check for deterioration and damage (cracks, deformation, and so on) on tubes/bottles before using them. Do not use the tubes/ bottles if you find such a problem.
  - Be sure to mount the rotor cover if provided. Check that the rotor cover is completely secured with a screw if provided.
  - Mount the rotor onto the drive shaft gently and properly. Do not drop the rotor or apply excessive force to the drive shaft to avoid damage to the drive shaft.
  - Clean the inside of the drive hole (crown hole) of the rotor and the surface of the drive shaft (crown) of the centrifuge once a month.
  - When storing the rotor on a shelf, make sure that the shelf is secured (for example, to avoid the rotor from dropping during an earthquake).
  - If dewdrops are in the rotor chamber, drain the chamber through the drain hose to prevent the sample to get mixed up with them or prevent them from leaking into the drive unit. Be sure to recap the drain hose after drainage.
  - Do not pour any liquid such as water, detergent and disinfectant directly into the rotor chamber.  
If you do so, the bearings of the drive unit might corrode or deteriorate.
  - Do not operate the display panel (Touchscreen) using a ballpoint pen.
  - Before relocating the centrifuge, remove the rotor from the rotor chamber to avoid damaging to the drive shaft.

---

# SAFETY NOTICES

---



## ○ Safety During Installation and/or Maintenance

-  **DANGER:**
- To avoid electrical shock hazards, follow below when servicing the centrifuge.
    - 1) Be sure to turn off the POWER switch and turn off the distribution board of your centrifuge room if your centrifuge is equipped with a three wire power cord. Then wait at least three minutes and then remove covers or tables from the centrifuge.
    - 2) Be sure to turn off the POWER switch and unplug the power cord from the receptacle if your centrifuge is equipped with a power cord with a plug. Then wait at least three minutes and then remove covers or tables from the centrifuge.

-  **WARNING:**
- Elevate the centrifuge completely by using the four level adjusters and level it. If the centrifuge is elevated incompletely, it can cause significant movement of the centrifuge in the event of the rotor disengagement.
  - Do not remove the adapter of the inner of the door, the cover of the left side of the centrifuge and the caps of the inside of rotor chamber except using a continuous flow rotor in the CR22N refrigerated centrifuge. The CR22N refrigerated centrifuge does not conform to the CE marking requirements when using a continuous flow rotor due to the construction of the rotor. Do not remove the adapter of the inner of the door, the cover of the left side of the centrifuge and the caps of the inside of rotor chamber if your centrifuge is the CR21N refrigerated centrifuge. A continuous flow rotor is not applicable to the CR21N refrigerated centrifuge.
  - Installation or relocation of your centrifuge must be done by the authorized service representative. Contact an authorized sales or service representative.
  - Repairs, disassembly, and other modifications to the centrifuge are strictly prohibited unless performed by an authorized sales or service representative.
  - Avoid a place exposed to ultraviolet rays for operation or storage of the centrifuge. Otherwise, the covers can be discolored and the coating can be peeled off easily. If installation in such place is unavoidable, cover the centrifuge with a cloth after operation to protect from ultraviolet rays.

 **CAUTION:**

## ○ Electrical Safety

-  **WARNING:**
- Your centrifuge must be grounded properly to avoid electrical shock hazards.
-  **CAUTION:**
- Do not place containers holding liquid in the rotor chamber or on or near the instrument. If they spill, liquid may get into the instrument and damage electrical components.

## ○ Safety against Risk of Fire

-  **WARNING:**
- This centrifuge is not explosion proof centrifuge. Never use explosive or flammable samples, or materials that chemically react vigorously. Do not centrifuge such materials in this instrument nor handle or store them near the instrument.

---

 SAFETY NOTICES

---

## ○Chemical and Biological Safety

- ⚠ WARNING:**
- Take all necessary safety measures before using samples that are toxic or radioactive, or blood samples that are pathogenic or infectious. You use such samples at your own responsibility.
  - Take all necessary safety measures when Risk Group II materials (as identified in the World Health Organization “Laboratory Biosafety Manual”) are handled, and that more than one level of protection shall be provided in the case of materials of a higher group.
  - If the centrifuge, rotor, or an accessory is contaminated by samples that are toxic or radioactive, or blood samples that are pathogenic or infectious, be sure to decontaminate the item according to good laboratory procedures and methods.  
If there is a possibility that the centrifuge, rotor, or an accessory is contaminated by samples that might impair human health (for example, samples that are toxic or radioactive, or blood samples that are pathogenic or infectious), it is your responsibility to sterilize or decontaminate the centrifuge, rotor, or the accessory properly before requesting repairs from an authorized sales or service representative.
  - It is your responsibility to sterilize and/or decontaminate the centrifuge, rotor, or parts properly before returning them to an authorized sales or service representative.

### Notice for an Earthquake

Depending on the magnitude, an earthquake might damage the centrifuge. If you observe some abnormality, stop using the centrifuge immediately and ask for inspection by the authorized service representative.

# SAFETY NOTICES

## WARNING

- Never use any materials capable of producing flammable or explosive vapors.
- Be sure to take the necessary precautions before separating radioactive, toxic or pathogenic materials.

## CAUTION

- Be sure to install the rotor cover and tighten the handle securely.



Exposed protrusions can cause severe injury. Do not put your hands on the table when closing the door.

- The gas spring is a consumable part. It deteriorates due to long-term use. Replace the gas spring with a new one if it is impossible to keep the door open.

## CAUTION

- When setting the rotor on the drive shaft, adjust it up and down 2 or 3 times in order to confirm that it is correctly in place.
- Foreign substances from broken or leaky tubes and other sources will interfere with the operation of this machine. Monthly cleaning of the drive shaft, the drive hole of the rotor and the chamber is highly recommended.

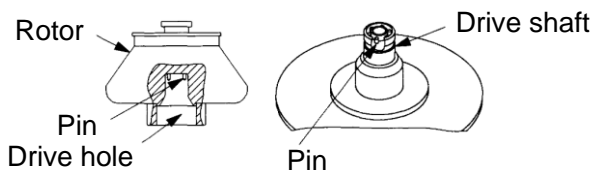

## CAUTION

Sharp fins  
Can cause severe injury.  
Do not touch the radiator fins.

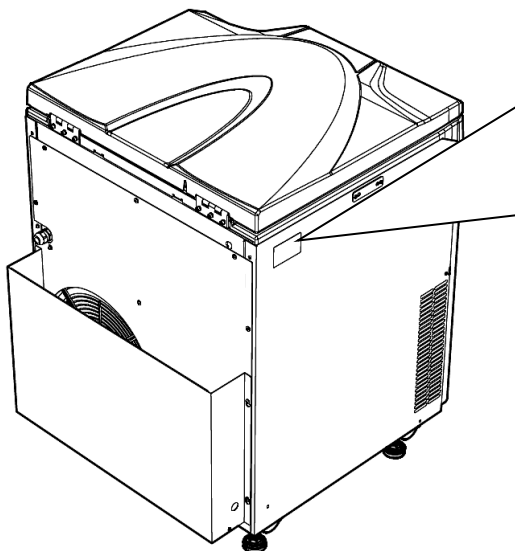
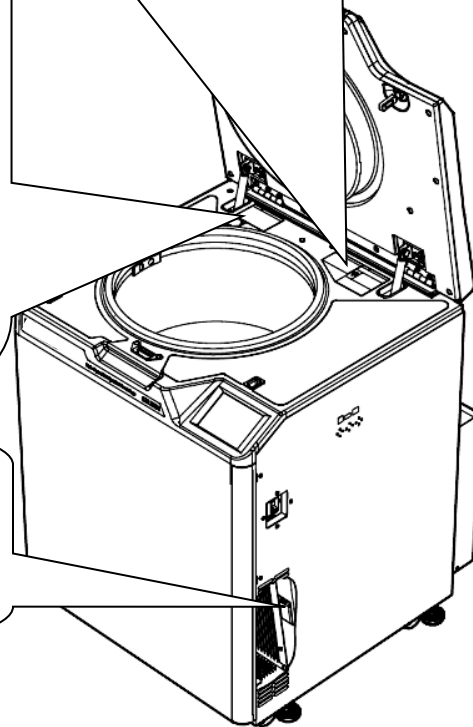

## Example of the Device nameplate

<b>himac</b>			
<b>CENTRIFUGE</b>			
TYPE	CR22N		
MAX.SPEED	22,000	rpm	
VOLT.	208	V	50/60 Hz
CUR.	24	A	
KIN.ENERGY	164	kJ	
MFG.NO.			

Made in Japan

Eppendorf Himac Technologies Co., Ltd. 1060 Takeda, Hitachinaka, Ibaraki 312-8502, Japan



---

# Table of Contents

---

1. Description	1-1
1-1 External View of Centrifuge	1-1
1-2 Structure	1-2
1-2-1 Touchscreen	1-2
1-2-2 POWER Switch	1-5
1-2-3 Safety Device	1-5
2. Operation	2-1
2-1 Run Preparation	2-2
2-1-1 Starting up This Machine	2-2
2-1-2 ROTOR	2-3
2-2 Basic Operation	2-4
2-2-1 Setting Run Conditions	2-4
2-2-2 Operational Procedure	2-9
2-2-3 Acceleration Rate and Deceleration Rate	2-12
2-2-4 Variable Deceleration Slope Function (CR22N only)	2-13
2-3 How to Use the FUNCTION Area	2-15
2-3-1 Programmed Operation	2-16
2-3-2 Step-Mode Operation	2-30
2-3-3 Displaying and Setting RCF	2-32
2-3-4 Displaying and Setting g-sec	2-37
2-3-5 RTC (real-time control) Operation	2-40
2-4 Selecting the Rotor	2-44
2-5 User Login	2-46
2-6 Features of the MENU Screen	2-48
2-6-1 Displaying the Run History and Loading the Information About Run Parameters	2-49
2-6-2 Rotor Catalog	2-50
2-6-3 Customizing the Settings	2-51
2-6-4 Administrator (Admin) Functions	2-55
2-7 Emergency Recovery from Power Failure	2-75
3. Maintenance	3-1
3-1 Rotor Chamber	3-2
3-2 Drive Shaft (Crown)	3-2
3-3 Cabinet	3-2
3-4 Rotor	3-3
3-5 Replacement Parts	3-3
3-6 Others	3-3

---

# Table of Contents

---

4. Troubleshooting .....	4-1
4-1 Alarm Messages .....	4-2
(1) Corrective actions .....	4-2
4-2 User-Corrected Problems .....	4-3
5. Installation and Relocation .....	5-1
6. Specifications .....	6-1
7. List of Standard Accessories.....	7-1
8. Tubes and Bottles .....	8-1

## APPENDIX

Decontamination sheet

WEEE Compliance

Marking for the restriction of the use of hazardous substances in electrical and electronic product  
(THE PEOPLE'S REPUBLIC OF CHINA)

# 1. Structure

This section explains the appearance and the structure of the main components of the CR-N series refrigerated centrifuge.

## 1-1 External View of Centrifuge

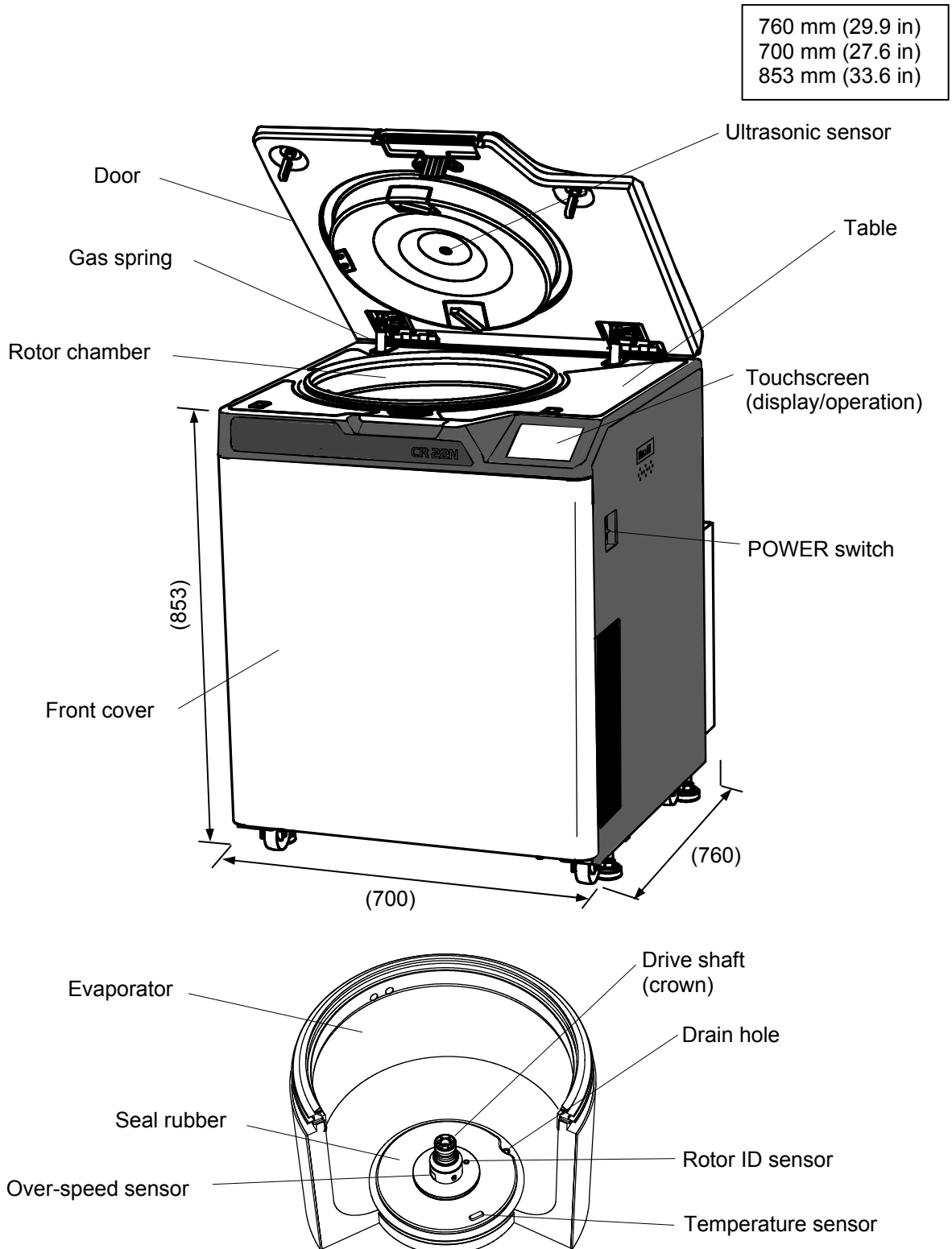

## 1-2 Structure

### 1-2-1 Touchscreen

The touchscreen with color liquid crystal screen is incorporated in this centrifuge. You can set the run conditions, perform the operation, and display Run History, Programmed Run, and User Customizations Screens by pressing the screen.

Fig. 1-2-1 shows the touchscreen.

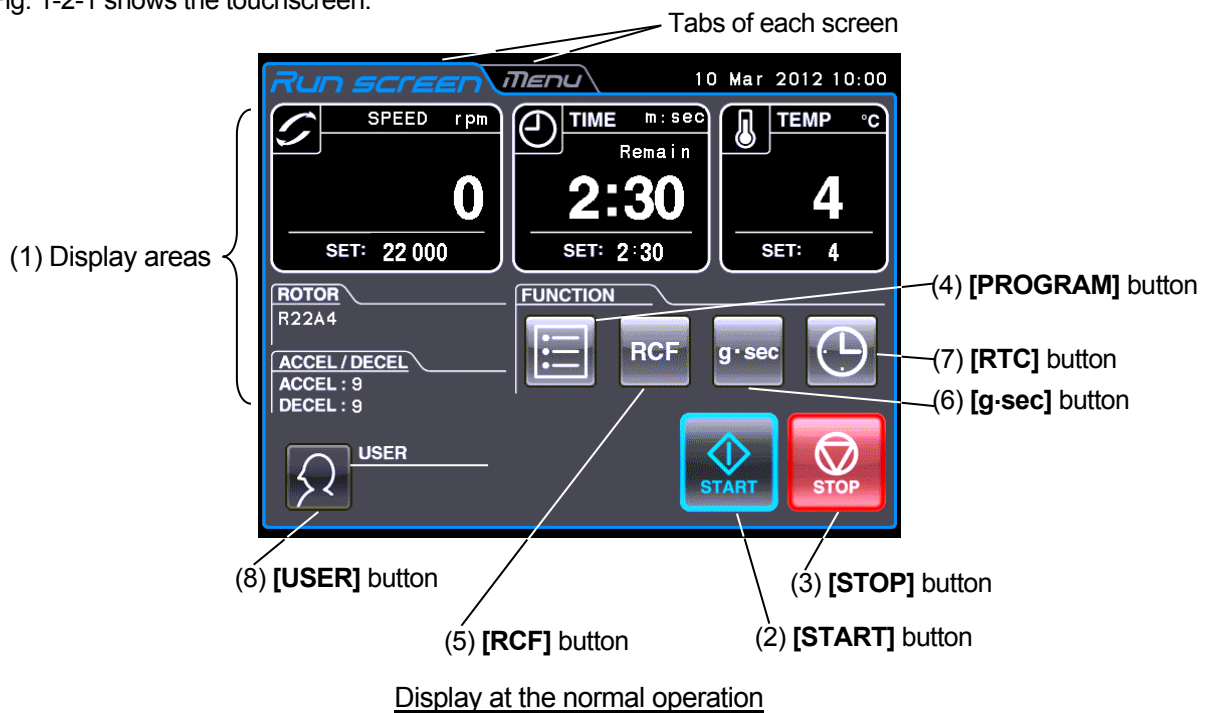



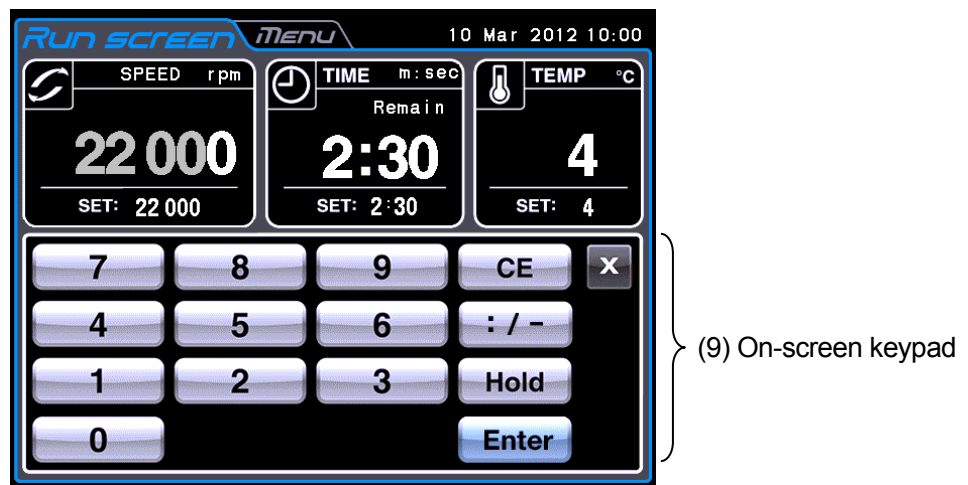



The following screen appears by pressing the **SPEED**, **TIME**, or **TEMP** area.



Display when setting the run conditions such as the speed etc.





Fig. 1-2-1 Touchscreen

## [Functions of the Run screen]

No.	Name and symbol	Functions and actions
(1)	Display areas:  SPEED area   TIME area   TEMP area   Rotor indicator   ACCEL/DECEL area 	These areas display various types of information. The SPEED, TIME, and TEMP areas display the current status in the upper part and the specified setting in the lower part (For settings, see section 2-2-1). <ul style="list-style-type: none"> <li>● <b>SPEED</b> (Rotational speed indicator)                Upper part: Displays the speed in increments of 10 rpm when lower than 10,000 rpm, and in increments of 100 rpm when 10,000 rpm or more.                Lower part: Used to set, and displays, a speed from 300 to the maximum speed in increments of 10 rpm when lower than 10,000 rpm, and in increments of 100 rpm when 10,000 rpm or more. The lowest digit (1 position) displays zero.                Maximum speed CR22N : 22,000 rpm                CR21N : 21,000 rpm</li> <li>● <b>TIME</b> (Running time indicator)                Upper part: Displays the remaining operation time. If the running time is set to HOLD, the upper part displays the elapsed time.                Lower part: Used to set, and displays, a range from 1 second to 99 minutes 59 seconds in increment of seconds and minutes.                (Option: Used to set, and displays, a range from 1 minute from 99 hours 59 minutes in increment of minutes and hours.)</li> <li>● <b>TEMP</b> (Temperature indicator)                Upper part: Displays the temperature in increments of 1 °C.                Lower part: Used to set, and displays, a temperature in the range from -20 °C to 40 °C in increments of 1 °C.</li> <li>● <b>ROTOR</b> (Rotor indicator)                Press this area to select the desired rotor.</li> </ul> Press this area to set the acceleration and deceleration rate. <ul style="list-style-type: none"> <li>● <b>ACCEL</b> (Acceleration mode indicator)                Displays acceleration modes 1 through 9.</li> <li>● <b>DECEL</b> (Deceleration mode indicator)                Displays deceleration modes 1 through 9, along with free coasting (0).                Displays "SLOW" or "FREE", and deceleration mode change speed when the DECEL SLOPE (variable deceleration slope function) is chosen. (CR22N only)</li> </ul>
(2)	 button	Press this button to start rotor rotation.
(3)	 button	Press this button to stop rotor rotation.

[Functions of the Run screen]



[Functions of the on-screen keypad]

No.	Name and symbol	Functions and actions
(4)	 button	Press this button to specify program settings and so on (see section 2-3-1).
(5)	 button	Displays the RCF (relative centrifugal force) values. Press this button to an RCF value (see section 2-3-3).
(6)	 button	Displays the g·sec values. Press this button to a g·sec value (see section 2-3-4).
(7)	 button	Press this button to set a start time or finish time (see section 2-3-5).
(8)	 USER area	Displays the user name (see section 2-6-4).

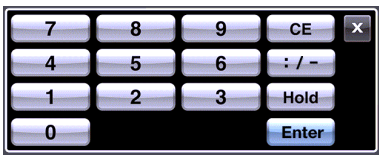
[Functions of the on-screen keypad]

No.	Name and symbol	Functions and actions
(9)	On-screen keypad 	Use the on-screen keypad to enter numeric values for run parameters. <b>[ : / - ]</b> When entering a time: Switches from minutes to seconds. (Option: Switches from hours to minutes.) When entering a temperature: If a temperature is below zero, press this to enter “minus sign (-)”. <b>[Hold]</b> When entering the operation time: Sets continuous running. <b>[CE]</b> Press this to cancel input (for example, if you enter the wrong number or the wrong value for a run parameter). <b>[Enter]</b> Press this to save the entered setting. <b>[x]</b> Press this to close the on-screen keypad.

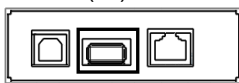
[External connection]

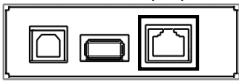
No.	Name and symbol	Functions and actions
(10)	USB (host side) (10) 	Use the USB connection to output the operation history of the centrifuge to USB memory. (CR22N only)
(11)	USB (device side) (11) 	Use for connecting optional items.
(12)	LAN (12) 	Use for connecting the LAN cable (to establish communication between “himac LogManager” (option) on your computer and the centrifuge).

### 1-2-2 POWER Switch

The POWER switch applies electric power to the centrifuge.

「 | 」 : ON

「 O 」 : OFF

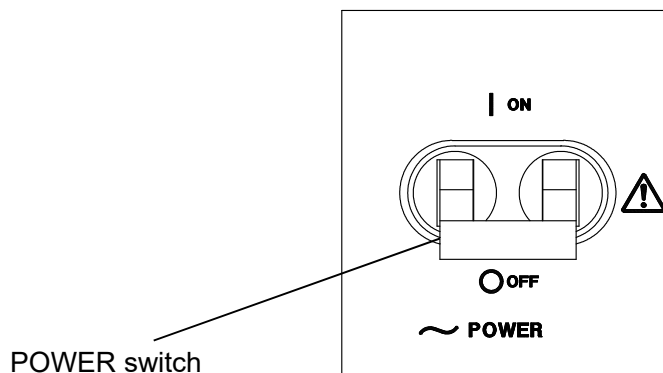

Fig. 1-2-2 POWER Switch

### 1-2-3 Safety Device

(1) Protector of rotor chamber

The rotor chamber allows the rotor to rotate at high speed. To prevent any rotor mishap during centrifugation, a steel protector is provided around the chamber for operator safety.

(2) Imbalance detector

This centrifuge is equipped with a sensor that detects severe vibration of the rotor due to improper bucket setting or excessive imbalance, and decelerates the rotor when detecting it.

(3) Door lock

For the sake of safety, the door is automatically locked while the rotor is rotating. The locked state is held even if the instrument power is turned off. The door can be opened/closed only when the rotor stops.

(4) Dual-overspeed detector

This centrifuge is equipped with a sensor that does not allow the rotor to rotate over the allowable maximum speed.

- 1.If improper speed over the allowable maximum speed is set, the overspeed detector detects it when the rotor is running at low speed (300 rpm) and displays an alarm message "SPEED".
- 2.Even if the improper operation exceeding over the allowable maximum speed is occurred, the centrifuge is equipped with the CPU that detects over-speed . Then it stops the rotor for operator safety.

(5) Rotor cover detector

Operation without the rotor cover can cause disengagement of rotor due to buoyant force. This centrifuge is equipped with a sensor that detects absence of the rotor cover and decelerates the rotor for operator safety.

However, if condensation or stains cover the back door ultrasonic sensor it may be impossible to detect the presence of the rotor cover.

If the ultrasonic sensor is covered, clean it with a soft cloth.

There might be other reasons for the ultrasonic sensor to be unable to detect the rotor cover, thus always mount the rotor cover correctly prior to operation when using rotors equipped with the cover.

## 2. Operation

The centrifuge operates in a variety of ways so that it may be applied for a wide range of use. A brief description of each mode of operation is given below.

		Brief description	Reference	
Normal operation			 Section 2-2 "Basic Operation"	
Add-on features	Programmed operation	You can save set run conditions in memory for later use in repeated operation.	 Section 2-3-1 "Programmed Operation"	
	Step-mode operation	Three normal operations can be combined in a sequence of operations.		 Section 2-3-2 "Step-Mode Operation"
	RTC operation (Real Time Control)	Automatic centrifugation can be performed by setting the desired date and time in advance.		 Section 2-3-5 "RTC (real-time control) Operation"
	Displaying and setting RCF (Relative Centrifugal Force)	The centrifuge automatically computes RCF values from set speed, or speed from set RCF values, and then displays the result of computation on the control panel	 Section 2-3-3 "Displaying and Setting RCF"	
	Displaying and setting g-sec	This centrifuge automatically computes and displays integrator (g-sec) values from RCF and run time. The centrifuge can also be operated by entering integrator (g-sec) values.	 Section 2-3-4 "Displaying and Setting g-sec"	
	Lockout system function	This function is used to limit the users of the centrifuge.	 Section 2-6-4 (2) "User Lockout"	
	Variable deceleration slope function	This function is used to separate samples that are apt to be disturbed during deceleration.		 Section 2-2-4 "Variable Deceleration Slope Function (CR22N only)"



## 2-1 Run Preparation

**⚠ WARNING:** 1. This centrifuge is not explosion proof centrifuge. Never use explosive or flammable samples, or materials that chemically react vigorously. Do not centrifuge such materials in this instrument nor handle or store them near the instrument.

2. Take all necessary safety measures before using samples that are toxic or radioactive, or blood samples that are pathogenic or infectious. You use such samples at your own responsibility.

**⚠ CAUTION:** Do not place containers holding liquid in the rotor chamber, on the centrifuge, or near the centrifuge. If spilt, liquid might get into the instrument and damage electrical and mechanical components.

### 2-1-1 Starting up This Machine

Before setting run conditions, display the Run screen (Screen for setting run conditions)

(1) Displaying the Run screen (Screen for setting run conditions)

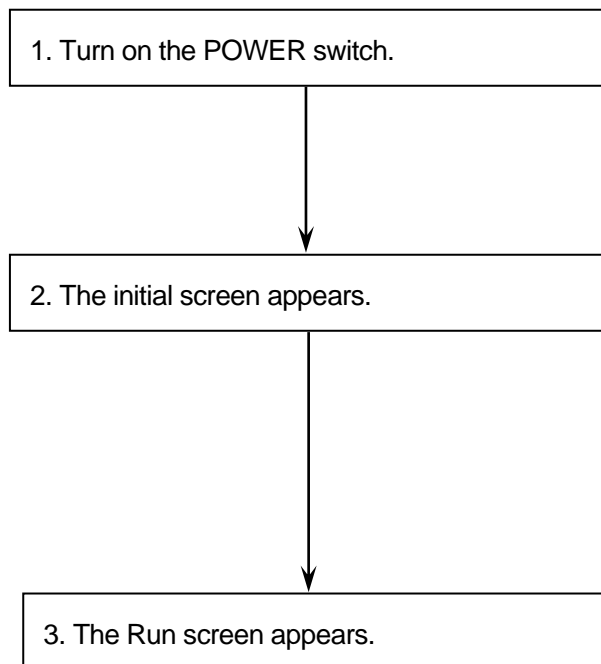

[Initial screen]

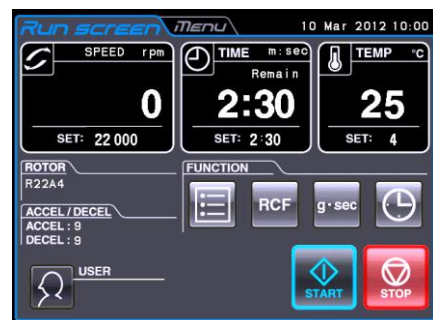

[Run screen]

Fig.2-1-1 Initial Screen and Run Screen

## 2-1-2 ROTOR

- ⚠ WARNING:**
1. Never use any rotor, bucket, assembly, etc. that is not designated for the centrifuge by us.
  2. Do not use corroded, scratched or cracked rotor, buckets and assemblies. Check that the rotor, buckets and assemblies are free of such abnormalities before operation.
  3. Do not exceed the maximum rated speed of the rotor or buckets in use.
  4. Be sure to set all the buckets of the same serial number.
  5. The rotor speed should be limited depending on the mean density of sample and the sample weight. Refer to the rotor instruction manual for details.
  6. Do not remove the adapter of the inner of the door, the cover of the left side of the centrifuge and the caps of the inside of rotor chamber except using a continuous flow rotor in the CR22N refrigerated centrifuge.  
The CR22N refrigerated centrifuge does not conform to the CE marking requirements when using a continuous flow rotor due to the construction of the rotor.  
Do not remove the adapter of the inner of the door, the cover of the left side of the centrifuge and the caps of the inside of rotor chamber if your centrifuge is the CR21N refrigerated centrifuge. A continuous flow rotor is not applicable to the CR21N refrigerated centrifuge.

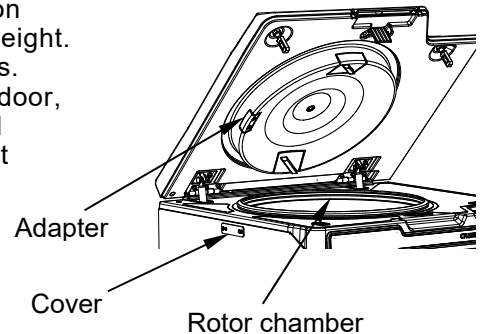

- ⚠ CAUTION :**
1. Read the rotor instruction manual thoroughly before use.
  2. Never use any adapter, tube or bottle that is not designated for the centrifuge by us.
  3. Mount the rotor cover securely.
  4. Do not exceed the allowable imbalance.
  5. Be careful that imbalance operation may occur in the following cases. Fill the same sample in the same tubes/bottles and load them in the buckets that are placed symmetrically with respect to the drive shaft in the rotor.
    - If samples that are equal in volume but different in composition are used, the precipitation levels may be different by centrifugation and such operation may increase the level of imbalance.
    - If samples that are equal in weight but different in volume (density) are used or if the tubes/bottles are different in inside diameter, material, or shape, there may be variations in position of center of gravity and such operation may cause imbalance.
  6. Be sure to set all the plates and all the plate adapters when using the horizontal rotor.
  7. Do not run this centrifuge over the allowable maximum speed of the rotor, buckets, tube, bottle, tube/bottle cap, and adapters. If their maximum speeds vary, run it at the lowest maximum speed among them. The allowable maximum speed may be limited depend on the combination of the tube/bottle, the tube/bottle cap, and the adapter. For the allowable maximum speed, refer to the rotor instruction manual provided with the rotor. When using tubes on the market, perform operation under the allowable speed or the allowable RCF specified by the manufacturer. Otherwise the tubes may be broken during operation.
  8. Although the tubes/bottles are balanced within the allowable range, imbalance alarm may occur when setting the acceleration rate 8 or less depending on the combination of the tubes/ bottles and the rotor. Balance them more accurately.
  9. If condensation or stains cover the back door ultrasonic sensor it may be impossible to detect the presence of the rotor cover.  
If the ultrasonic sensor is covered, clean it with a soft cloth.  
There might be other reasons for the ultrasonic sensor to be unable to detect the rotor cover, thus always mount the rotor cover correctly prior to operation when using rotors equipped with the cover.

For the specifications of applicable rotors to this centrifuge, refer to the “Applicable rotors to the CR-N series centrifuge”.

## 2-2 Basic Operation

**⚠ WARNING:** Do not incline or move the instrument while the rotor is spinning.  
Do not place any object on the instrument or lean on the instrument.

**⚠ CAUTION:** 1. Do not press the touchscreen with a sharp-pointed object such as a ballpoint pen.  
2. If abnormal sound is heard during the operation, stop the operation immediately and contact an authorized sales or service representative.

### 2-2-1 Setting Run Conditions

This section will first describe the screen for basic operation (the Run screen). For the display at the normal operation and the display when setting the run conditions, refer to Section 1-2-1.

#### [Run screen]

The screen for displaying the specified setting and current status is called the Run screen.

The SPEED, TIME, and TEMP areas display the current status in the upper part and the specified setting in the lower part.

The acceleration (ACCEL) and the deceleration (DECEL) area displays the specified setting.

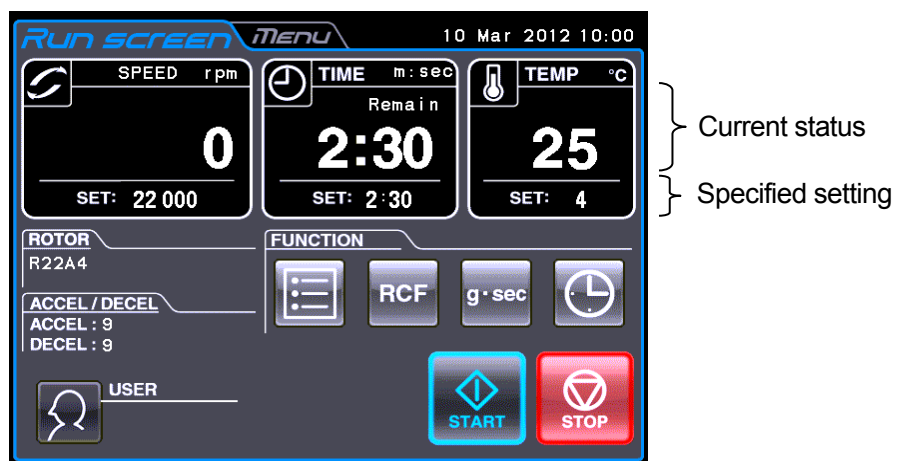
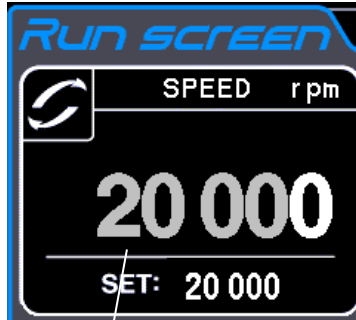

Fig. 2-2-1 (1) Run Screen

**Display and operations when entering the run parameters**

The on-screen keypad appears by pressing the SPEED area, TIME area, TEMP, or ACCEL/DECEL area.

- (1) Press the area of the desired item to turn the upper part blue.



Color of the upper part : Blue

- (2) Enter the desired numeric value with the on-screen keypad.  
(e.g.) SPEED:22,000rpm  
Press the [2] [2] [0] [0].

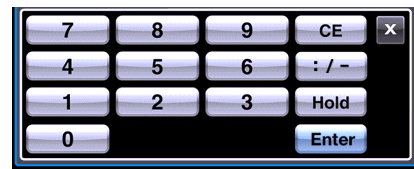

[On-screen keypad]



- (3) If you do not want to change any other setting, press the [Enter] button on the on-screen keypad.  
If you want to change other settings, press the area of the desired item, and the pressed area will become the input wait state.  
The new setting is displayed in the lower part of the pressed area.

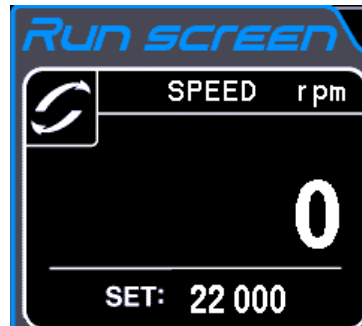

Fig. 2-2-1 Displaying the New Setting









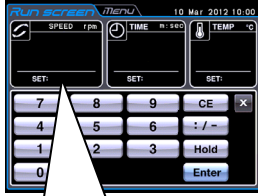
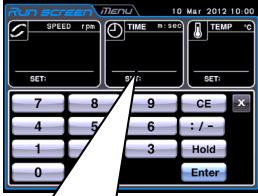
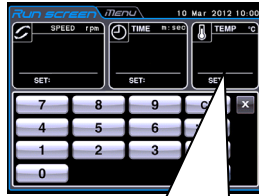
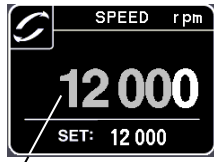

The next page describes how to set run condition by citing some examples.

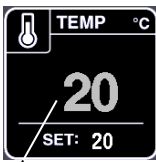
**NOTE**

- (1) If you enter the wrong value, press the **[CE]** button and then enter the correct value.  
If you have pressed the **[Enter]** button, repeat step (1) of the previous page, and then enter the correct value.
- (2) When setting the two or more of three run conditions (SPEED, TIME, and TEMP), you do not have to press the **[Enter]** button after each setting. You can store the setting by pressing the desired item.
- (3) If the system is running in (HOLD) and you want to set it to shut down at a future time, enter a new time setting while the instrument is in operation; enter the sum of the time elapsed plus the time remaining. If, for example, this machine has run continuously for five minutes and you want to stop it one and a half minutes later, press the TIME area, then enter **[6] [:-] [3] [0]**.

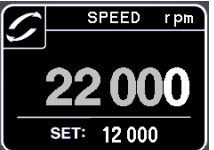

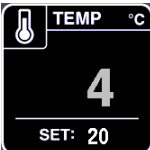
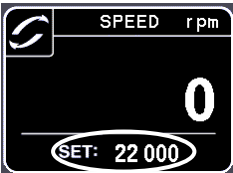

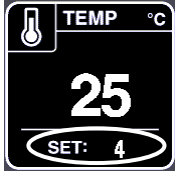

• **How to set speed, running time, and temperature**

Here are some examples and descriptions:

Setting item		RPM (SPEED)	Running time (TIME)	Temperature (TEMP)	
Typical setting		22,000rpm	2 minutes 30 seconds	4°C	
Operation procedure	1				
	2	Press the SPEED, TIME, or TEMP area to show the on-screen keypad.			
	3	The last entered value is displayed in each area. Press the area of the desired item again if the color of the upper part is white. Go to procedure 3 if the color of the upper part is blue.			
	4	Enter the desired numeric value with the on-screen keypad.			
	Entered numbers are moved to the left every time a new number is entered.				
	Make a check, then if you want to change other setting, press the area of the desired item. If you do not want to change any other setting, press the [Enter] button. Use the [CE] button to cancel input.	Set it to 22,000rpm.	Set it to 2 : 30. (2 minutes 30 seconds)	Set it to 4°C	
					
Setting range and units		1. Can be set to any value in the range from 300 rpm to 9,990 rpm in increments of 10 rpm. 2. Can be set to any value in the range from 10,000 rpm to maximum speed in increments of 100 rpm.	Can be set to any value up to 99 minutes 59 seconds in increments of 1 minute. (Option: Can be set to any value up to 99 hours 59 minutes in increments of 1 minute.)	Can be set to any value in the range from -20 °C to 40 °C in increments of 1 °C.	

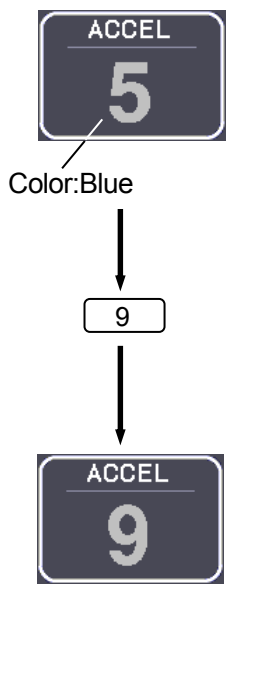
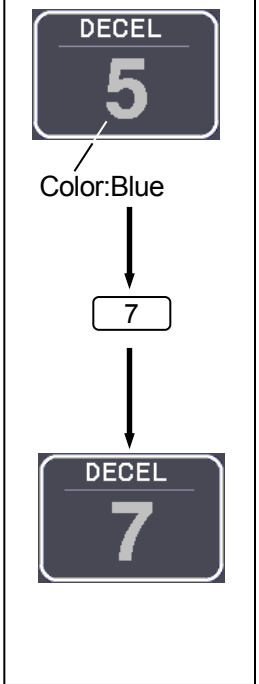
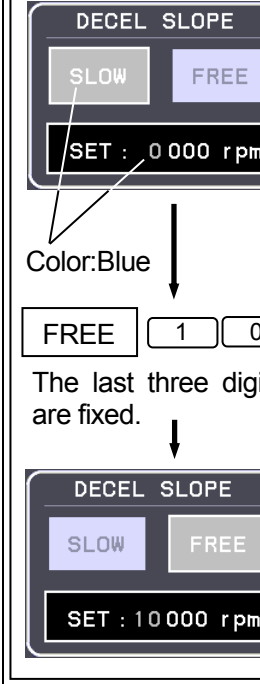
• How to set acceleration, deceleration, and deceleration slope



Here are some examples and descriptions:

Setting item		Acceleration (ACCEL)	Deceleration (DECCEL)	Deceleration slope (DECCEL SLOPE) (CR22N only)
Typical setting		9	7	FREE-10000rpm
Operation procedure	1			
		Press the ACCEL/DECCEL area to show the on-screen keypad.		
	2	Press the area of the desired item.		
	3	Enter the desired numeric value with the on-screen keypad.		
				
4	Make a check, then if you want to change other setting, press the area of the desired item. If you do not want to change any other setting, press the [Enter] button. <b>NOTE</b> You can not set DECCEL and DECCEL SLOPE at the same time. Choose between the DECCEL and DECCEL SLOPE. Use the [CE] button to cancel input.	Set it to 9.	Set it to 7.	Set it to FREE and 10000 rpm.
				
Setting range and units		1-9	0-9 (0: Free coasting)	SLOW or Free + 1000-10000 rpm

## 2-2-2 Operational Procedure

Given below is a description of the operational procedure for a normal run.

**NOTE** Before starting up this machine, carefully read the operation manual for your rotor and make sure that you have selected the correct type of tubes and injected the correct amount of sample.

Step	Touch panel operation	Screen displays and notes
1	Turn on the POWER switch on this machine.	<ul style="list-style-type: none"> <li>Run screen appears.</li> </ul>
2	Install the rotor.	<ul style="list-style-type: none"> <li>Install the rotor securely on the crown.</li> <li>When using a rotor without rotor ID*, press the Rotor indicator and select the desired rotor in the "Rotor Management" screen or "ROTOR CATALOG" screen.</li> <li>When using a rotor with rotor ID*, the rotor model appears on the Rotor indicator during operation. There is no need to select the rotor.</li> <li>Always mount the rotor cover correctly prior to operation when using rotors equipped with the cover.</li> </ul>
3	Set run conditions.	<ul style="list-style-type: none"> <li>See Section 2-2-1 "Setting run conditions" and set run conditions.</li> </ul>
4	Close the door.	<ul style="list-style-type: none"> <li>The below icon does not disappear on the Run screen, if the door is not closed completely. If the below icon does not disappear on the Run screen, close the door completely.</li> </ul> 
5	Press the <b>[START]</b> button. 	<ul style="list-style-type: none"> <li>When the door is locked, you can hear the beep sound from the centrifuge.</li> <li><b>⚠ WARNING:</b> When pressing the <b>[START]</b> button after closing the centrifuge door, the door is locked and the operation starts. When the door is locked, you can hear the beep sound from the centrifuge. When the door is locked, do not catch your fingers and objects in the space between the centrifuge door and the centrifuge table. Failure to do so can cause your fingers to be injured and failure to do so can cause the centrifuge to be damaged.</li> <li>The <b>[START]</b> button blinks and the rotor starts turning. (Note that rotors will stand by at 50rpm for about 10 seconds during acceleration and then go up to the set speed.)</li> <li>The timer begins operating. (When the actual run timer is activated, the timer begins operating after the speed reaches the set speed.)</li> <li>When the speed reaches the set speed, the <b>[START]</b> button lights up.</li> </ul>



Step	Touch panel operation	Screen displays and notes
6	<p>The specified centrifugation time elapses (time-out) or press the <b>[STOP]</b> button.</p> 	<ul style="list-style-type: none"> <li>The <b>[STOP]</b> button blinks and the rotor starts decelerating.</li> </ul> <p><b>NOTE</b> When the rotor starts decelerating, you can hear the hissing sound from the centrifuge for about three seconds. This is not a fault.</p>
7	The rotor stops.	<ul style="list-style-type: none"> <li>The <b>[STOP]</b> button lights up.</li> <li>The door is unlocked.</li> <li>The stop signal sounds to indicate that the rotor has stopped.</li> </ul>
8	Take out the rotor.	<ul style="list-style-type: none"> <li>Stop the rotor completely before taking it out.</li> </ul>

**NOTE** Take out the rotor from the centrifuge soon after the rotor has stopped. If the rotor is still installed on the crown after the rotor has stopped without opening the centrifuge door, small amounts of samples may be frozen.

\*Rotor ID (automatic discrimination function)

Rotors with rotor ID (i.e., automatic discrimination-type rotors) have blue adapters at the bottom and other rotors without rotor ID have black adapters.

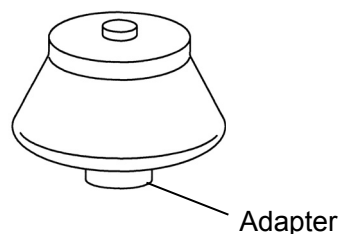

**NOTE** The rotors without the adapters are not available for this centrifuge.

Fig. 2-2-2 summarizes the operational procedure.

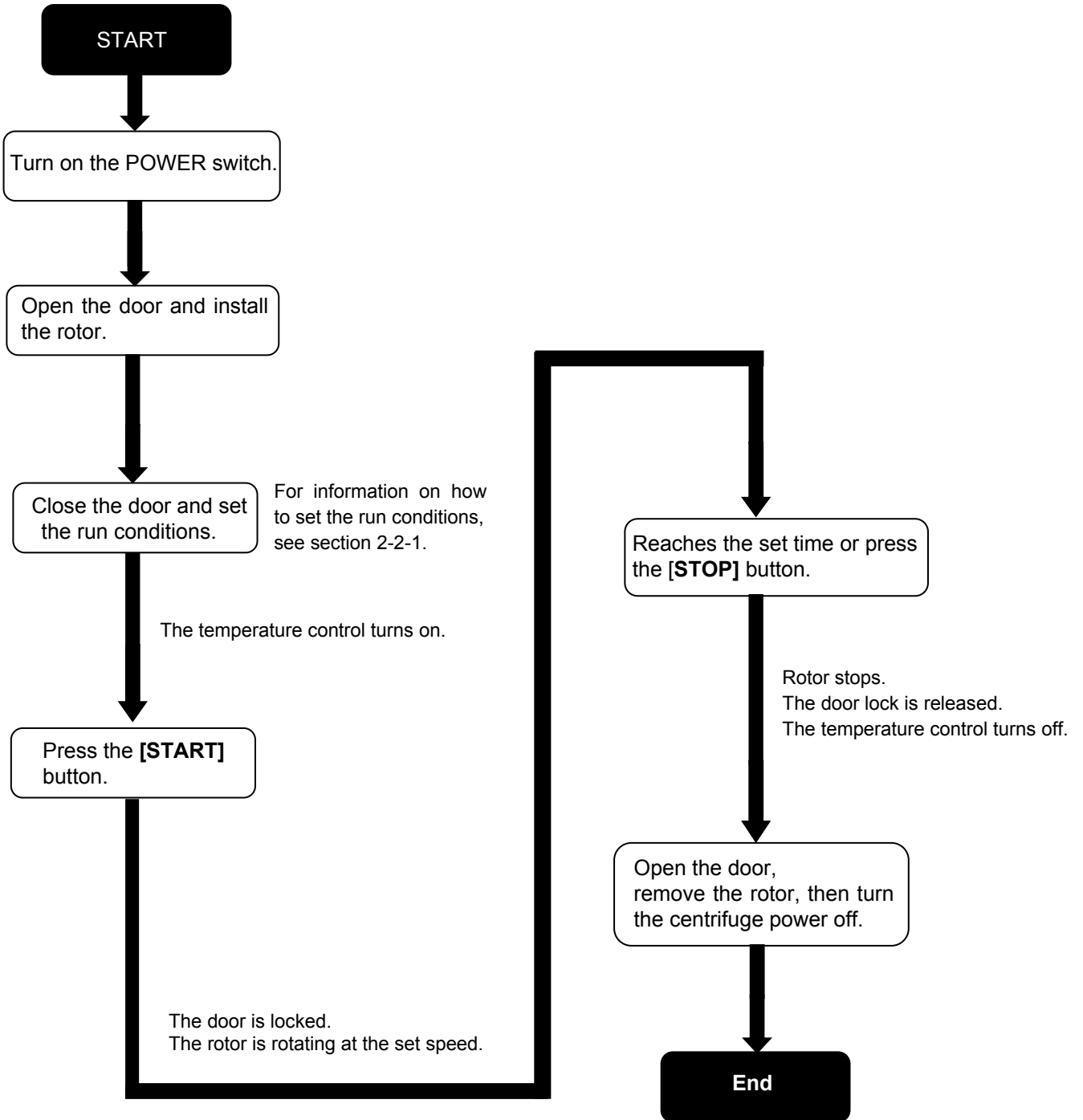
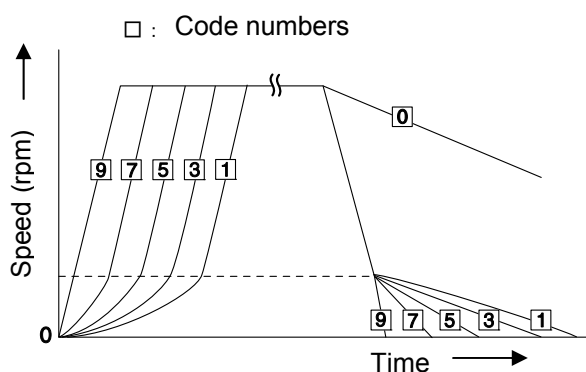

Fig. 2-2-2 Operational Procedure

### 2-2-3 Acceleration Rate and Deceleration Rate

The acceleration and deceleration rates can be adjusted for a wide range of use. The figure below shows how a rotor accelerates and decelerates in compliance with a code number selected from among 1 through 9.



Code No.	Time for acceleration from 0 to 500 rpm	Time for deceleration from 500 to 0 rpm
9	Minimum*	Minimum*
8	30 sec.	1 min.
7	45 sec.	2 min.
6	1 min.	3 min.
5	2 min.	4 min.
4	3 min.	6 min.
3	4 min.	9 min.
2	6 min.	12 min.
1	10 min.	15 min.
0	—	Coasting deceleration from set speed

**NOTE** These time values vary with the type of rotor in use.

\* The minimum time is the one that occurs when the rotor is being accelerated or decelerated with the maximum torque of the driving motor. This time varies with the type of rotor in use.

The variable deceleration slope function is designed for this centrifuge (see section 2-2-4).

## 2-2-4 Variable Deceleration Slope Function (CR22N only)

The variable deceleration slope function is designed for this centrifuge. Two slower deceleration slopes are selectable in addition to the same slope as the well-reputed slope of the conventional centrifuges. This function is effective for separation of samples that are apt to be disturbed. The deceleration mode is selectable from three SLOPEs, normal deceleration slope (NORMAL), slow deceleration slope (SLOW) and free coasting slope (FREE), and it is changeable from NORMAL to SLOW or FREE when the rotating speed is 10,000 rpm or lower as shown in the following example. The rotating speed is changeable to a desired speed between 1,000 rpm and 10,000 rpm in increments of 1,000 rpm. If the desired speed is higher than the set speed, it decelerates from the set speed to SLOW or FREE.

Example) Following is an example of operation using the variable deceleration slope function with the R22A3 rotor.

- ① Selection of the variable deceleration slope function  
Deceleration slope (SLOPE): SLOW  
Deceleration mode change speed (MODE CHANGE SPEED): 7,000 rpm
- ② Other setting  
Rotor: R22A3  
Speed: 22,000 rpm  
Time: 2 minutes and 30 seconds  
Temperature: 4°C  
Acceleration mode: 9

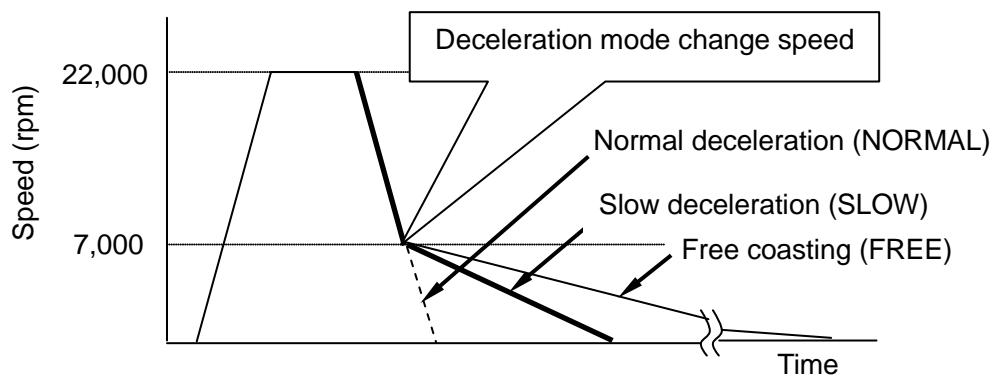

Fig. 2-2-4 (1) Example of Operation Using the Variable Deceleration Slope Function

**NOTE** The sample temperature might become lower than the set temperature if the code No. 0 of DECEL is chosen or the DECEL SLOPE is chosen. Although the set temperature is 4 °C, the sample may be frozen if the amount of the sample is small when the low capacity rotor is run at high speed.

【Screen for setting the DECEL SLOPE (Example: "SLOW-7000rpm")】

Fig. 2-2-4 (2) shows the screen for setting the DECEL SLOPE.  
"SLOW-7000rpm" is displayed in the Run screen (see fig. 2-2-4 (3)).

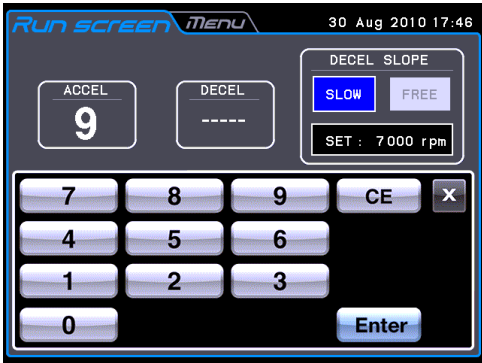

Fig. 2-2-4 (2)

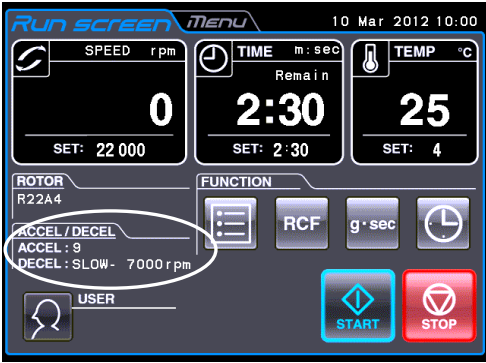

Fig. 2-2-4 (3)

\*Refer to section 2-2-1 for setting the DECEL SLOPE.

## 2-3 How to Use the FUNCTION Area

This centrifuge incorporates a number of features, such as step-mode and other programmed running, display and setting of centrifugal force, and RTC (real-time control) that can run the centrifuge at a required date and time. Buttons for these features are displayed and specified in the Run screen (FUNCTION area).

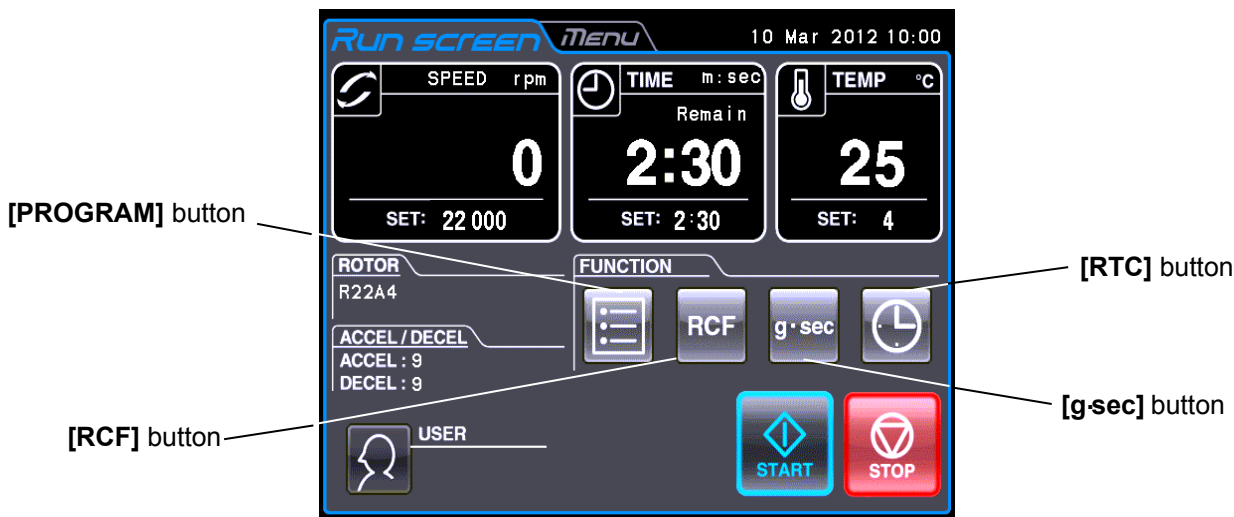

Fig. 2-3 Run Screen

Function	Icon (Button)	Description
PROGRAM		You can save run conditions in memory for later use in repeated operation. This feature also allows step-mode operation (three normal operations can be combined in a sequence of operations).
RCF		The centrifuge automatically computes and displays RCF values from set speed, or speed from set RCF values.
g-sec		The centrifuge automatically computes and displays integrator (g-sec) values from RCF and run time. The centrifuge can also be operated by entering integrator values.
RTC		Sets a start time or a finish time and runs the centrifuge at a desired date and time.

The above features can be used in combination.

**NOTE** To perform a combination of **PROGRAM** and **RTC**, first set **PROGRAM** and then set the **RTC**.  
Once **RTC** is activated, you cannot change the run time. You therefore cannot activate **PROGRAM**.

### 2-3-1 Programmed Operation

When a centrifugal condition is to be used frequently, entering the same condition every time you want to perform centrifugation is inconvenient.

This centrifuge has a programmed operation feature that stores run conditions. Storing run conditions which you often use allows you to call those conditions however often you may wish, thus saving time in setting. (Even while the POWER switch is OFF, this centrifuge retains the conditions entered.)

The memory in the centrifuge can contain 30 sets (No.1-No.30) of run parameters and 3 sets (No.31-No.33, No.41-No.43, No.51-No.53) of run parameters for three-step (step-mode) operations. After recording run parameters (speed, run time, temperature, etc.) for three-step operation, you can recall and perform those steps successively with the saved run conditions (i.e., step-mode operation).

(Basic operation of the programmed operation feature)

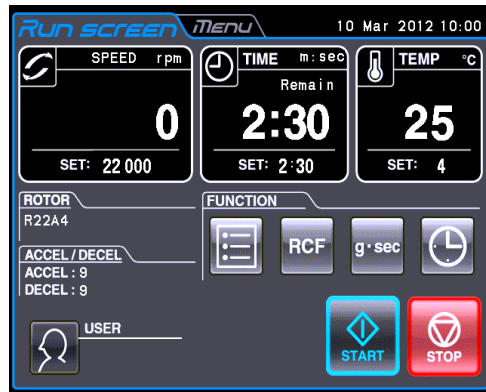

Press the **[PROGRAM]** button.



Box (for displaying a program No.)

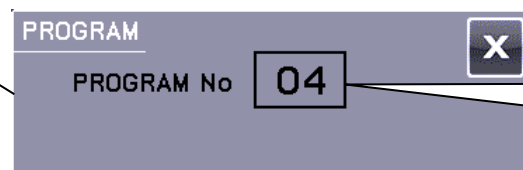

Program No. of the loaded run parameters is displayed.

Press the box (for displaying a program No.) (color: gray).



If the run parameters are stored, SPEED, TIME, TEMP, and REMARK are displayed.

[ < ] : Previous Page button  
 [ > ] : Next Page button

Press the row of the desired Program No.



↓

PROGRAM				
No.	SPEED	TIME	TEMP	REMARK
1	10 000	2:30	20	Test1
2				
3	22 000	15:30	4	R22A4
4	7 500	HOLD	25	LDH
5				

↓

The pressed row turns blue.

If you perform the programmed operation, → Press the **[Run]** button.

If you create or change a program, → Press the **[Select]** button.

If you delete a program, → Press the **[Delete]** button.



Press the **[Run]** button to go back to the Run screen. The loaded run parameters are displayed in the Run screen.

**NOTE** You cannot create, change, or delete a program while in running. Perform these operations while not in running.

\*If you do not know the Program No. of the program which you need, see Section 2-3-1 (2) (b).

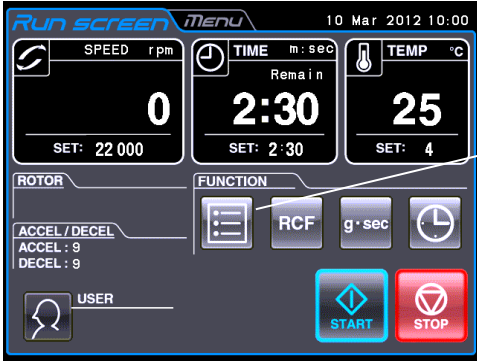

**(1) Programming procedure for run conditions (creating or changing)**

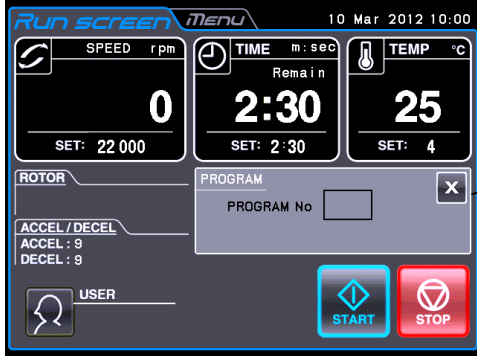
Shown below is the procedure for storing (creating) or changing an run condition.

Step	Touch panel operation	Screen displays and notes
1	In the FUNCTION area of the Run screen, press the  button.	<div style="text-align: center;">  <p>[PROGRAM] button</p> </div> <div style="text-align: center; margin: 10px 0;">  </div> <div style="text-align: center;">  <p>Box (for displaying a program No.)</p> </div> <ul style="list-style-type: none"> <li>• The box (for displaying a program No.) appears on the FUNCTION area.</li> <li>• If the Program No. is displayed in the PROGRAM No. box, it indicates that the run parameters which has been stored in this program are set.</li> </ul>

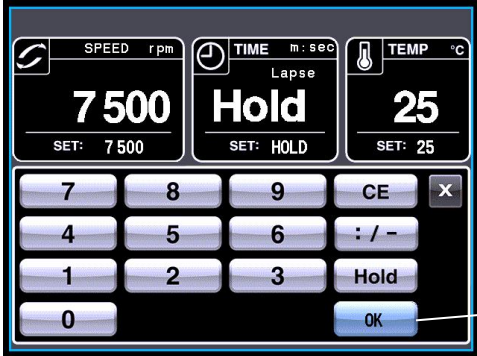
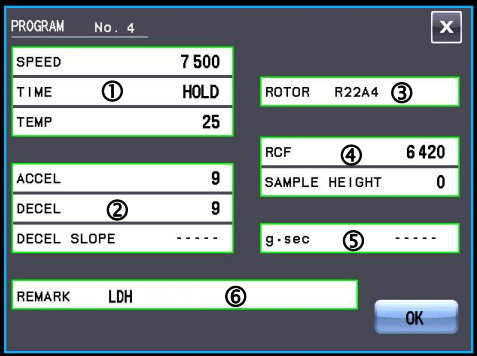
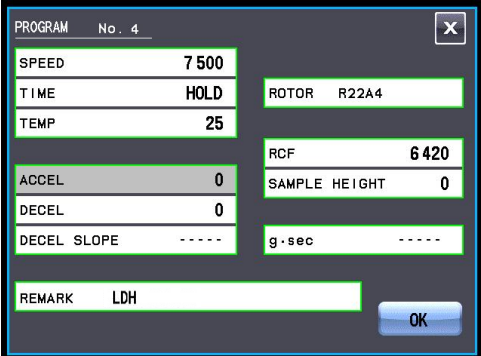
Step	Touch panel operation	Screen displays and notes																																																						
2	<p>Press the box (for displaying a program No.).</p>	<div data-bbox="657 392 1136 745" style="border: 1px solid black; padding: 5px;"> <p>PROGRAM</p> <table border="1"> <thead> <tr> <th>No.</th> <th>SPEED</th> <th>TIME</th> <th>TEMP</th> <th>REMARK</th> </tr> </thead> <tbody> <tr> <td>1</td> <td>10 000</td> <td>2:30</td> <td>20</td> <td>Test1</td> </tr> <tr> <td>2</td> <td></td> <td></td> <td></td> <td></td> </tr> <tr> <td>3</td> <td>22 000</td> <td>15:30</td> <td>4</td> <td>R22A4</td> </tr> <tr> <td>4</td> <td></td> <td></td> <td></td> <td></td> </tr> <tr> <td>5</td> <td></td> <td></td> <td></td> <td></td> </tr> </tbody> </table> <p>RUN &lt; &gt; Delete Select</p> </div> <ul style="list-style-type: none"> <li>● The PROGRAM screen appears.</li> <li>○ If a SPEED, REMARK, etc. are displayed in the row of a program No., run parameters have already been stored for that program.</li> <li>○ If you want to create a new program, press a row that does not display a SPEED, REMARK, etc.</li> </ul>	No.	SPEED	TIME	TEMP	REMARK	1	10 000	2:30	20	Test1	2					3	22 000	15:30	4	R22A4	4					5																												
No.	SPEED	TIME	TEMP	REMARK																																																				
1	10 000	2:30	20	Test1																																																				
2																																																								
3	22 000	15:30	4	R22A4																																																				
4																																																								
5																																																								
3	<p>Press the row of the program No. for which you want to create (or change) a program, and make sure that the pressed row turns blue.</p> <p>Then press the <b>[Select]</b> button.</p> <p>If you want to change a item of the program, press the item (①-⑥) which you want to change.</p>	<div data-bbox="663 940 1142 1294" style="border: 1px solid black; padding: 5px;"> <p>PROGRAM</p> <table border="1"> <thead> <tr> <th>No.</th> <th>SPEED</th> <th>TIME</th> <th>TEMP</th> <th>REMARK</th> </tr> </thead> <tbody> <tr> <td>1</td> <td>10 000</td> <td>2:30</td> <td>20</td> <td>Test1</td> </tr> <tr> <td>2</td> <td></td> <td></td> <td></td> <td></td> </tr> <tr> <td>3</td> <td>22 000</td> <td>15:30</td> <td>4</td> <td>R22A4</td> </tr> <tr> <td>4</td> <td></td> <td></td> <td></td> <td></td> </tr> <tr> <td>5</td> <td></td> <td></td> <td></td> <td></td> </tr> </tbody> </table> <p>RUN &lt; &gt; Delete Select</p> </div> <p>(If you want to store the run parameters as program No.4, press the row of the program No.4.)</p> <p><b>[Select]</b> button</p> <div style="text-align: center; margin: 10px 0;"> </div> <div data-bbox="657 1397 1142 1756" style="border: 1px solid black; padding: 5px;"> <p>PROGRAM No. 4</p> <table border="1"> <tbody> <tr> <td>SPEED</td> <td>0</td> <td>ROTOR</td> <td>③</td> </tr> <tr> <td>TIME ①</td> <td>0:00</td> <td>RCF</td> <td>④ -----</td> </tr> <tr> <td>TEMP</td> <td>0</td> <td>SAMPLE HEIGHT</td> <td>-----</td> </tr> <tr> <td>ACCEL</td> <td>0</td> <td>g·sec</td> <td>⑤ -----</td> </tr> <tr> <td>DECEL ②</td> <td>0</td> <td>REMARK</td> <td>⑥</td> </tr> <tr> <td>DECEL SLOPE</td> <td>-----</td> <td></td> <td></td> </tr> </tbody> </table> <p>OK</p> </div> <ul style="list-style-type: none"> <li>● The screen for displaying the run parameters appears.</li> <li>① SPEED/TIME/TEMP fields display the specified setting.</li> <li>② ACCEL/ DECEL, and DECEL SLOPE fields display the specified setting.</li> <li>③ ROTOR field displays the specified rotor.</li> <li>④ RCF / SAMPLe HEIGHT fields display the specified setting.</li> <li>⑤ g·sec fields display the specified setting.</li> <li>⑥ REMARK fields display the entered remark.</li> </ul>	No.	SPEED	TIME	TEMP	REMARK	1	10 000	2:30	20	Test1	2					3	22 000	15:30	4	R22A4	4					5					SPEED	0	ROTOR	③	TIME ①	0:00	RCF	④ -----	TEMP	0	SAMPLE HEIGHT	-----	ACCEL	0	g·sec	⑤ -----	DECEL ②	0	REMARK	⑥	DECEL SLOPE	-----		
No.	SPEED	TIME	TEMP	REMARK																																																				
1	10 000	2:30	20	Test1																																																				
2																																																								
3	22 000	15:30	4	R22A4																																																				
4																																																								
5																																																								
SPEED	0	ROTOR	③																																																					
TIME ①	0:00	RCF	④ -----																																																					
TEMP	0	SAMPLE HEIGHT	-----																																																					
ACCEL	0	g·sec	⑤ -----																																																					
DECEL ②	0	REMARK	⑥																																																					
DECEL SLOPE	-----																																																							

Step	Touch panel operation	Screen displays and notes
<p>4</p>	<p>Enter run parameters as follows:</p> <p>a) Press the area of the item which you want to change. Using the on-screen keypad, enter the run parameters (see section 2-2-1).</p> <div data-bbox="256 779 619 1205" style="border: 1px solid black; padding: 5px; margin: 10px 0;"> <p>Example:                      SPEED: 7,500 rpm                      TIME: HOLD                      TEMP: 25 °C                      ACCEL:9 / DECEL:9                      ROTOR: R22A4                      RCF: 6420                      SAMPLE HEIGHT: 0                      g.sec:-----                      REMARK: LDH</p> </div> <p>b) After entering the run parameters, press the <b>[OK]</b> button.</p> <p>Entering the numeric values for SPEED, TIME, TEMP, ACCEL, and DECEL (or DECEL SLOPE) is necessary.</p> <p>If you do not enter the numeric values for them, The field on which you do not enter the numeric value turns red.</p> <p>If you enter the wrong numeric values for them, The field on which you enter the wrong numeric value turns red.</p>	<p>Screen displays and notes</p> <p>a) The on-screen keypad appears.</p>  <p>[OK] button</p> <p>b) The screen for displaying the run parameters appears.</p>  <p>(If you do not enter the numeric value for ACCEL, the following screen appears.)</p>  <ul style="list-style-type: none"> <li>○ Be sure to enter numeric values for SPEED, TIME, TEMP, ACCEL, and DECEL (or DECEL SLOPE).                      (For a programmed operation, it is not necessary to select a rotor name, and enter remarks, and enter numeric values for RCF, SAMPLE HEIGHT, and g.sec.)</li> <li>○ If you do not enter a numeric value for SPEED, you can not select ROTOR(③).</li> <li>○ If you do not select a rotor name, you can not enter numeric values for RCF(④) and g.sec(⑤).</li> </ul>

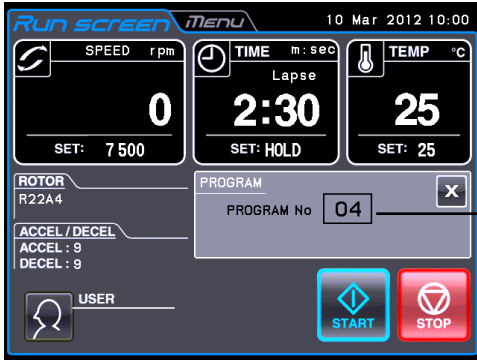

Step	Touch panel operation	Screen displays and notes
5	<p>Press the row of the program No. for which you created (or changed) a program, and make sure that the pressed row turns blue. Then press the <b>[RUN]</b> button.</p>	<div style="display: flex; align-items: flex-start;"> <div style="flex: 1;">  <p style="text-align: center;">↓</p>  <p style="text-align: center;">RUN button</p> </div> <div style="flex: 1; padding-left: 20px;"> <ul style="list-style-type: none"> <li>• The PROGRAM screen appears.</li>            <li>(If you pressed the row of the program No.4, it turned blue.)</li> </ul> </div> </div>
6		<div style="display: flex; align-items: flex-start;"> <div style="flex: 1;">  <p style="text-align: right; margin-right: 20px;">Program No.</p> </div> <div style="flex: 1; padding-left: 20px;"> <ul style="list-style-type: none"> <li>• Run screen appears.</li> </ul> </div> </div>



- NOTE**
- (1) If you make and store changes in a row that already stores run parameters, the previous parameters are replaced by the new parameters.
  - (2) You cannot store a run parameter while in running (while the rotor is rotating). Always perform this function while not in running.

**(2) How to perform a programmed operation**

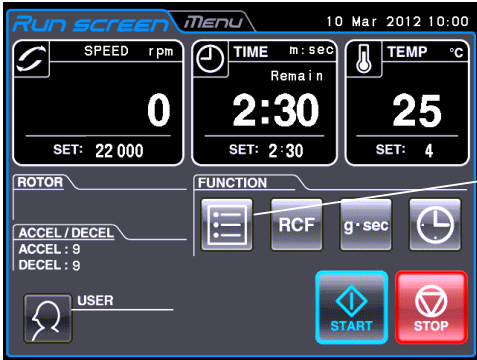
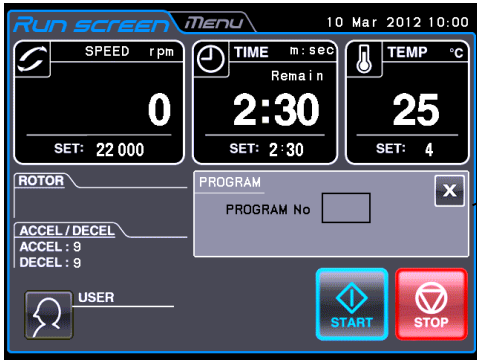

Shown below is how to perform a “programmed operation”, that is, how to call a stored set of run parameters and run this centrifuge accordingly.

(a) If you know the program No. you need

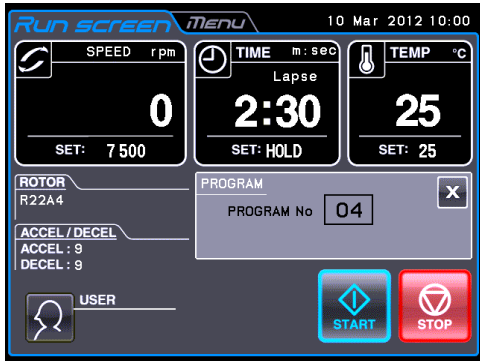

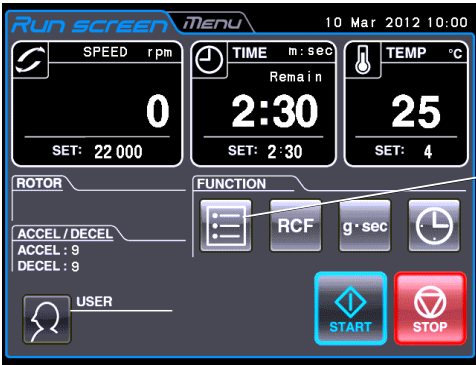
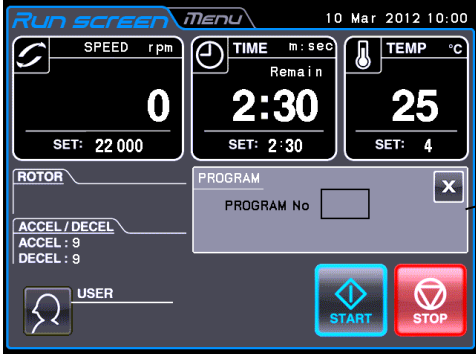

Step	Touch panel operation	Screen displays and notes
1	Turn on the POWER switch on the centrifuge.	○Runscreen appears.
2	In the FUNCTION area of the Run screen, press the  button.	 <p>[PROGRAM] button</p> <p style="text-align: center;">↓</p>  <ul style="list-style-type: none"> <li>• The box (for displaying a program No.) appears in the FUNCTION area.</li> <li>• Box (for displaying a program No.)</li> </ul>
3	Press the box (for displaying a program No.).	 <ul style="list-style-type: none"> <li>• The PROGRAM screen appears.</li> </ul>

Step	Touch panel operation	Screen displays and notes
4	Press the row of the program No. for which you want to run a program, and make sure that the pressed row turns blue. Then press the <b>[RUN]</b> button.	<div style="text-align: center;">  <p data-bbox="667 779 845 824">RUN button</p>  </div> <div style="display: flex; justify-content: space-between;"> <div style="width: 60%;">  </div> <div style="width: 35%;"> <ul style="list-style-type: none"> <li>• The loaded run parameters are displayed on the Run screen.</li> <li>• The program No. is displayed on the box (for displaying a program No.).</li> </ul> </div> </div> <p data-bbox="644 1227 1437 1294">○ You can not select the row of the program No. that does not store run parameters.</p>
5	Run the centrifuge under normal operation without making changes to the run parameters.	<p data-bbox="644 1330 1437 1397">○ Run this centrifuge according to Section 2-2-2 “Operational Procedure”.</p> <p data-bbox="644 1402 1437 1496">○ If you make changes to the run parameters (such as SPEED and TIME) after calling a program, the program you have just called is canceled. You must call it again to use it.</p>

(b) If you do not know the Program No. of the program which you need

Step	Touch panel operation	Screen displays and notes
1	Turn on the POWER switch on the centrifuge.	○Runscreen appears.
2	In the FUNCTION area of the Run screen, press the  button.	 <p>[PROGRAM] button</p> <p style="text-align: center;">↓</p>  <ul style="list-style-type: none"> <li>The box (for displaying a program No.) appears on the FUNCTION area.</li> <li>Box (for displaying a program No.)</li> </ul>
3	Press the box (for displaying a program No.).	 <ul style="list-style-type: none"> <li>The PROGRAM screen appears.</li> </ul>

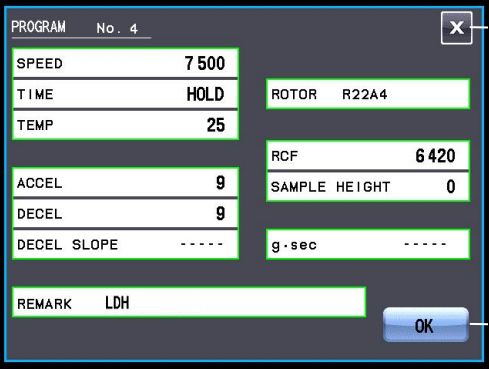



Step	Touch panel operation	Screen displays and notes
4	<p>① Press the row of the program No. for which you want to check a program, and make sure that the pressed row turns blue. Then press the <b>[Select]</b> button.</p> <p>② Check each field (run parameters etc.). If you want to select this program, press the <b>[OK]</b> button. (Proceed to step 5.)</p> <p>If you do not want to select this program, press the <b>[x]</b> button. (Proceed to step 4-①.)</p>	 <p><b>[RUN]</b> button</p> <p><b>[Select]</b> button</p>   <p><b>[x]</b> button</p> <p><b>[OK]</b> button</p> <ul style="list-style-type: none"> <li>○ You can not select the row of the program No. that does not store run parameters.</li> </ul>
5	<p>Run the centrifuge under normal operation without making changes to the run parameters.</p>	 <ul style="list-style-type: none"> <li>• The loaded run parameters are displayed in the Run screen.</li> <li>• The program No. is displayed in the box (for displaying a program No.).</li> </ul> <ul style="list-style-type: none"> <li>○ Run this centrifuge according to Section 2-2-2 “Operational Procedure”.</li> <li>○ If you make changes to the run parameters (such as SPEED and TIME) after calling a program, the program you have just called is canceled. You must call it again to use it.</li> </ul>

**NOTE** (1) To perform a combination of a programmed run with RTC (see Section 2-3-5 “RTC (real-time control) Operation”), call a programmed memory unit, then set RTC. The system will then calculate the total of the running times of all steps of the programmed run and calculate the start time for RTC. Therefore, cannot call the program memory after setting RTC.

### (3) Deleting a program

This section explains how to delete a program.

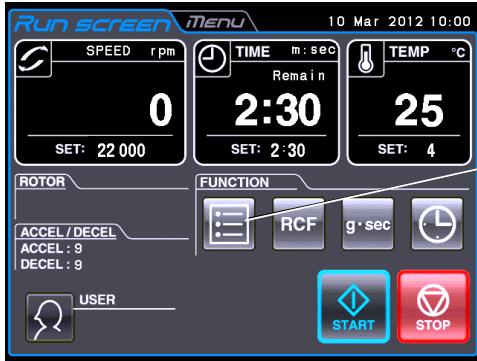
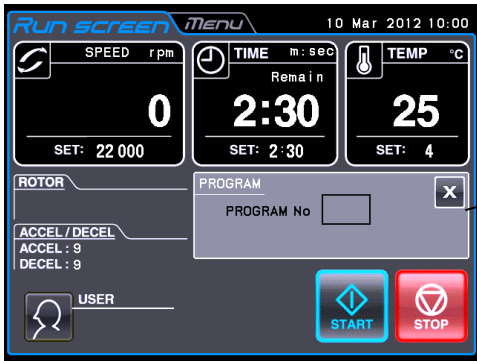
**NOTE** You cannot delete a program while in running (while the rotor is rotating). Always perform this function while not in running.

Step	Touch panel operation	Screen displays and notes
1	In the FUNCTION area of the Run screen, press the  button.	 <p>[PROGRAM] button</p> <p style="text-align: center;">↓</p>  <ul style="list-style-type: none"> <li>The box (for displaying a program No.) appears on the FUNCTION area.</li> <li>Box (for displaying a program No.)</li> </ul>
2	Press the box (for displaying a program No.).	 <ul style="list-style-type: none"> <li>The PROGRAM screen appears.</li> </ul>

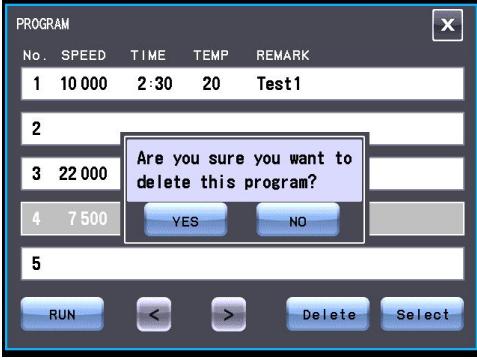
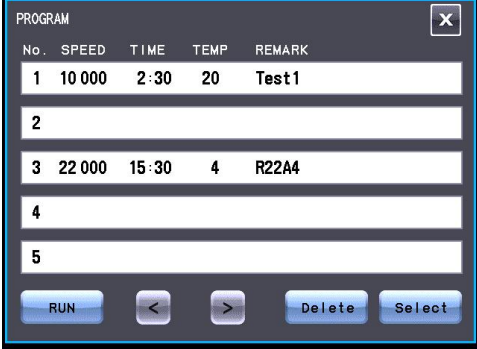
Step	Touch panel operation	Screen displays and notes																														
3	Press the row of the program No. for which you want to delete a program, and make sure that the pressed row turns blue. Then press the <b>[Delete]</b> button.	 <p>The screenshot shows a 'PROGRAM' screen with a table of programs. Program 4 is highlighted in blue. A confirmation dialog box is overlaid on the screen, asking 'Are you sure you want to delete this program?' with 'YES' and 'NO' buttons. The table below the dialog is as follows:</p> <table border="1"> <thead> <tr> <th>No.</th> <th>SPEED</th> <th>TIME</th> <th>TEMP</th> <th>REMARK</th> </tr> </thead> <tbody> <tr> <td>1</td> <td>10 000</td> <td>2:30</td> <td>20</td> <td>Test1</td> </tr> <tr> <td>2</td> <td></td> <td></td> <td></td> <td></td> </tr> <tr> <td>3</td> <td>22 000</td> <td></td> <td></td> <td></td> </tr> <tr> <td>4</td> <td>7 500</td> <td></td> <td></td> <td></td> </tr> <tr> <td>5</td> <td></td> <td></td> <td></td> <td></td> </tr> </tbody> </table> <p>Buttons at the bottom include RUN, navigation arrows, Delete, and Select.</p> <ul style="list-style-type: none"> <li>The deletion confirmation box is displayed.</li> </ul>	No.	SPEED	TIME	TEMP	REMARK	1	10 000	2:30	20	Test1	2					3	22 000				4	7 500				5				
No.	SPEED	TIME	TEMP	REMARK																												
1	10 000	2:30	20	Test1																												
2																																
3	22 000																															
4	7 500																															
5																																
4	Press the <b>[YES]</b> button on the deletion confirmation box.	 <p>The screenshot shows the 'PROGRAM' screen after program 4 has been deleted. Program 3 is now highlighted in blue. The table below is as follows:</p> <table border="1"> <thead> <tr> <th>No.</th> <th>SPEED</th> <th>TIME</th> <th>TEMP</th> <th>REMARK</th> </tr> </thead> <tbody> <tr> <td>1</td> <td>10 000</td> <td>2:30</td> <td>20</td> <td>Test1</td> </tr> <tr> <td>2</td> <td></td> <td></td> <td></td> <td></td> </tr> <tr> <td>3</td> <td>22 000</td> <td>15:30</td> <td>4</td> <td>R22A4</td> </tr> <tr> <td>4</td> <td></td> <td></td> <td></td> <td></td> </tr> <tr> <td>5</td> <td></td> <td></td> <td></td> <td></td> </tr> </tbody> </table> <p>Buttons at the bottom include RUN, navigation arrows, Delete, and Select.</p> <ul style="list-style-type: none"> <li>The program is deleted.</li> </ul>	No.	SPEED	TIME	TEMP	REMARK	1	10 000	2:30	20	Test1	2					3	22 000	15:30	4	R22A4	4					5				
No.	SPEED	TIME	TEMP	REMARK																												
1	10 000	2:30	20	Test1																												
2																																
3	22 000	15:30	4	R22A4																												
4																																
5																																

## 2-3-2 Step-Mode Operation

This centrifuge has the step-mode operation capability that allows you to save three different sets of values for a run parameter set in a single memory location (program No. 31 - 33, 41 - 43, and 51 - 53) and then change some or all of the run conditions (e.g., speed, run time, rotor temperature, etc.) for each step during a step-mode run. Save step-mode run conditions at the program No. 31 - 33 (41 - 43 or 51- 53) in accordance with "2-3-1 Programmed Operation (1)".

When the program No. 31 is recalled, the centrifuge automatically performs step-mode operation in order of program No. 31, 32 and 33.

### (1) How to activate a step-mode operation

[Typical settings]

Shown below is the example of a three-step run and how to activate a step-mode operation.

	1st step (Program No. 31)	2nd step (Program No. 32)	3rd step (Program No. 33)
Speed	1000 rpm	20000 rpm	5000 rpm
Run time	30 min	60 min	10 min
Temperature	4°C	4°C	4°C
Accel rate	9	9	9
Decel rate	9	9	7
Rotor	R20A2	R20A2	R20A2

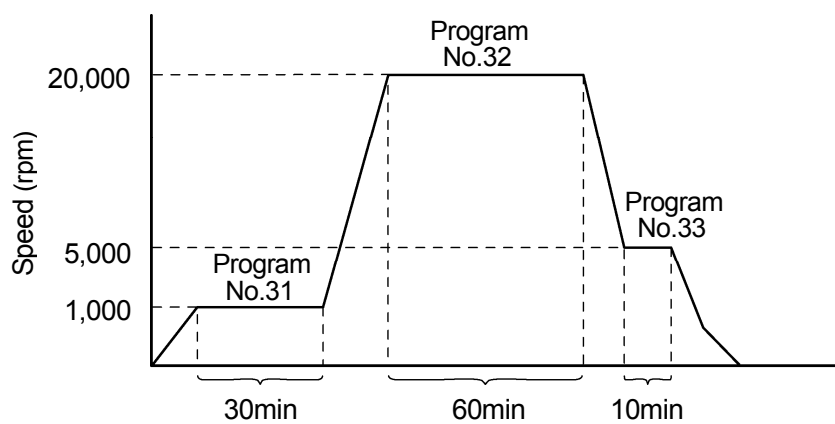

Fig. 2-3-2 (1) A typical Step-Mode Run

- NOTE**
- (1) Select the same rotor for each step. Otherwise, the centrifuge can not perform the step-mode operation.
  - (2) Use the program No. 32 and 33 (42 and 43 or 52 and 53) for the step-mode operation with two steps.
  - (3) During the step-mode operation, the following box appears in the FUNCTION area of the Run screen.

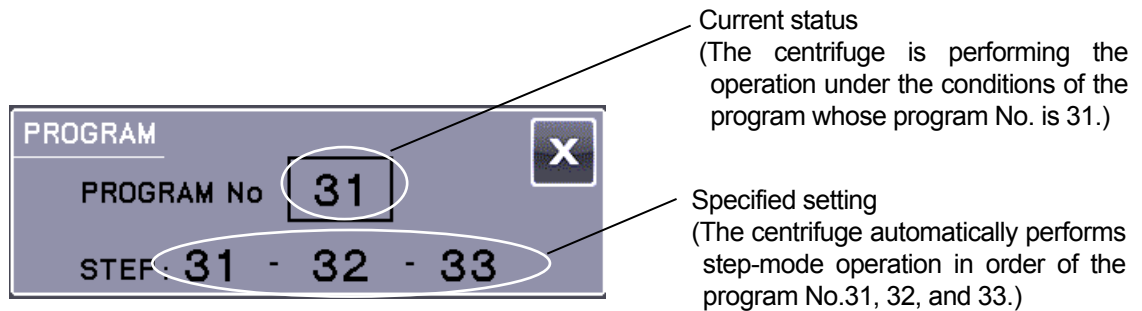

Fig. 2-3-2 (2) A Typical Box Which Appears During Step-Mode Operation

- (4) You can not store a run parameter while in running (while the rotor is rotating). Always perform this function while not in running.
- (5) To perform a combination of a step mode run with an RTC (real-time control) run (see Section 2-3-5 "RTC (real-time control) operation"), call a program, and then set RTC.

The system then calculates the total of running times of all steps of the programmed run and calculates the startup time for RTC. You therefore cannot call a program after setting RTC.

**(2) Other procedures**

- 1) Making changes to the run parameters  
 Call the program you want to make changes to and make the changes. Alternatively, delete the program, then store a new set of run parameters.
- 2) What if a SPEED alarm goes on?  
 If a step stores a speed exceeding the maximum allowable speed of your rotor, the system will detect it in the STEP1 run and display the SPEED alarm.  
 Double-check the speed of all steps and correct any wrong ones.
- 3) Stopping the centrifuge in operation  
 Press **[STOP]** button. The rotor stops and the system does not move to the next step.

**2-3-3 Displaying and Setting RCF**



This centrifuge stores the maximum and average radii of each rotor in the internal memory. Setting a speed causes this centrifuge to automatically calculate and display the RCF (relative centrifugal force) value, while setting an RCF value causes the centrifuge to automatically calculate and display the speed.

This section describes how to display and set a RCF value.

**NOTE** The RCF value computed from a certain speed and the speed computed from a certain RCF value may not be identical due to a residual in the numerical value.

**NOTE** Some applicable rotors to this centrifuge have outside tube cavities and inside tube cavities in them (see the rotor instruction manuals and “Applicable rotors to the CR-N series centrifuge”). This centrifuge can compute the RCF value and the speed in outside tube cavities. Some applicable rotors to this centrifuge have large tube cavities and small tube cavities in them (see the rotor instruction manuals and “Applicable rotors to the CR-N series centrifuge”). This centrifuge can compute the RCF value and the speed in large tube cavities.

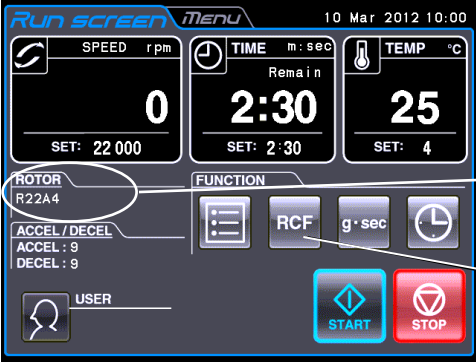
**(1) How to display and set a RCF value**

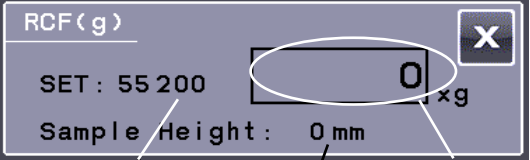
Step	Touch panel operation	Screen displays and notes
1	<p>Check that the desired rotor is displayed in the ROTOR indicator of the Run screen.</p> <p>When the desired rotor is not displayed, press the ROTOR indicator to show the ROTOR CATALOG screen.</p> <p>(For selecting the rotor, refer to section 2-4.)</p>	 <p>Labels in the screenshot:                  - ROTOR indicator: R22A4                  - [RCF] button: Located in the FUNCTION area.                  - START and STOP buttons: Located at the bottom right.</p>
2	<p>In the FUNCTION area of the Run screen, press the  button.</p>	 <p>Labels in the screenshot:                  - Specified setting of a RCF value: 55 200                  - Specified setting of a Sample Height: 0 mm                  - Box for displaying a RCF(g): The box containing the current RCF value (0).                  - Current status of a RCF value: 0 xg</p> <ul style="list-style-type: none"> <li>The box (for displaying a RCF(g)) appears in the FUNCTION area.</li> </ul> <p>○When there is no rotor name on the ROTOR indicator, even if you press the RCF button, the above box does not appear.</p> <p>○ The specified setting of a RCF value, the specified setting of a Sample Height, and the current status of a RCF value are displayed in the above box.</p>

Step	Touch panel operation	Screen displays and notes
3	<p>Press the box (for displaying a RCF(g)).</p>	<div style="text-align: center;"> </div> <ul style="list-style-type: none"> <li>• Screen for setting a RCF value appears.</li> </ul> <p>Specified setting of a RCF value</p> <p>Specified setting of a SPEED</p> <p>Specified setting of a SAMPLE HEIGHT</p> <p>Specified setting of a RCF(g) value, the specified setting of a SPEED, and the specified setting of a Sample Height are displayed in the screen for setting a RCF value. The specified setting of a SPEED displayed in this screen is the same as the specified setting of a SPEED displayed in the Run screen.</p>
4	<p>Press the area of desired item.</p> <p>If the color of the upper part is blue, proceed to step 5.</p> <p>If you want to set a SAMPLE HEIGHT, proceed to step 6.</p>	<div style="text-align: center;"> </div> <ul style="list-style-type: none"> <li>• The upper part turns blue.</li> </ul> <p>Color: blue</p> <p>If you want to change other settings, press the area of the desired item, and the pressed area will become the input wait state.</p>

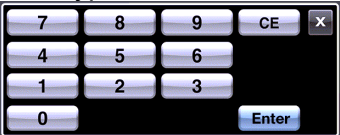
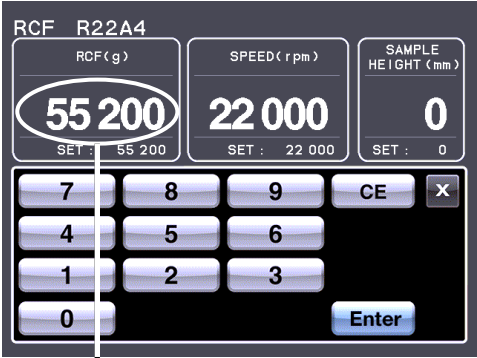
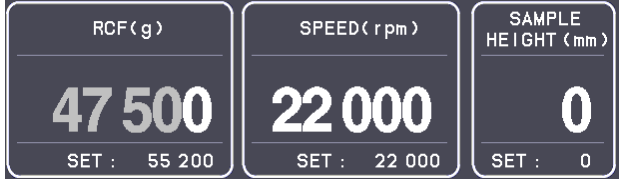
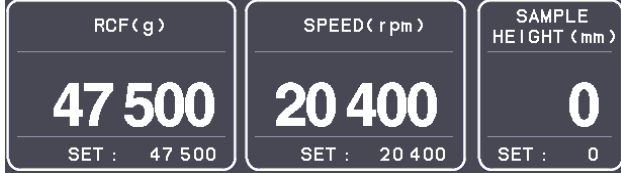

Step	Touch panel operation	Screen displays and notes
5	<p>a) Enter the desired numeric value with the on-screen keypad.</p>  <p>Entered numbers are moved to the left every time a new number is entered. (The last one digit is fixed.)</p> <p>b) Press the <b>[Enter]</b> button.</p> <p>Use the <b>[CE]</b> button to cancel input.</p> <p>If you do not need to set a Sample Height, press the <b>[x]</b> button.</p> <p>The Run screen reappears.</p>	<p>[Setting a RCF value and SPEED] e.g.) RCF(g) value: "47500"</p>  <p><b>[4] [7] [5] [0]</b> a) The color of the entered numbers is blue.</p>  <p>Press the <b>[Enter]</b> button.</p> <div style="border: 1px solid black; padding: 5px; width: fit-content; margin: 10px auto;"> <p>The SPEED is computed from the set Sample Height and the entered RCF(g).</p> </div> <p>b) The computed SPEED is displayed in the lower part of the SPEED area of the Run screen.</p>  <p>o You can set a SPEED in the same way that you set a RCF value.</p> <p>The RCF(g) is computed from the set Sample Height and the entered SPEED.</p>

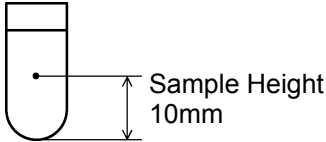
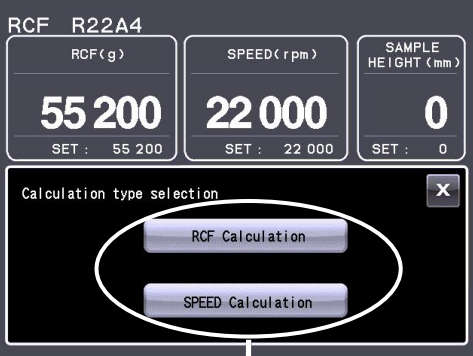
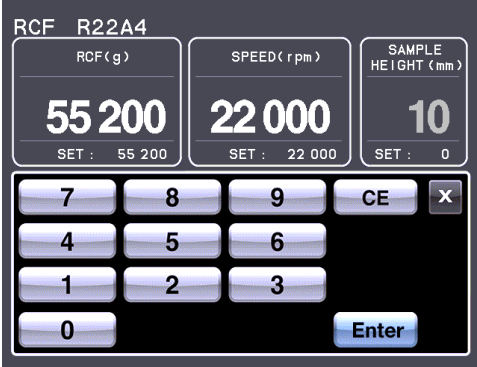
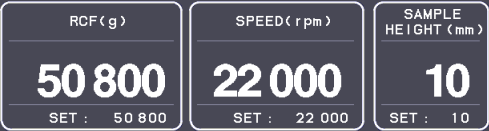

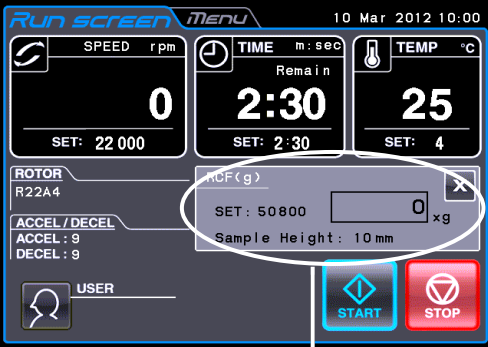
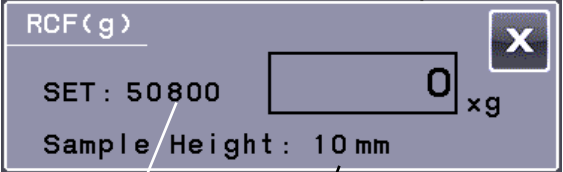
Step	Touch panel operation	Screen displays and notes
6	<p>[Setting a Sample Height]</p> <p>Press the SAMPLE HEIGHT area.</p> <p>a) Press the <b>[RCF calculation]</b> button or <b>[SPEED calculation]</b> button.</p>  <p>b) Use the on-screen keypad to enter the desired numeric value for a Sample Height.</p> <p>c) Press the <b>[Enter]</b> button.</p> <p>Use the <b>[CE]</b> button to cancel input.</p>	<p>[Setting a Sample Height]</p> <p>e.g.) Sample Height: "10"</p>  <p>a) The area (for choosing between the RCF calculation and the SPEED calculation) appears.</p> <p>Press the <b>[RCF calculation]</b> button and press <b>[1]</b> and <b>[0]</b> with the on-screen keypad.</p>  <p>b) The color of the entered numbers is blue.</p> <p>Press the <b>[Enter]</b> button.</p> <p>RCF calculation: The RCF(g) is computed from the entered Sample Height and the set SPEED.</p> <p>SPEED calculation The SPEED is computed from the entered Sample Height and the set RCF(g).</p>  <p>c) The computed RCF(g) is displayed in the RCF(g) area.</p>

Step	Touch panel operation	Screen displays and notes
7	<p>If you do not need to set a RCF value or a SPEED, press the [x] button.</p> <p>The Run screen reappears.</p>	<div style="display: flex; align-items: flex-start;"> <div style="flex: 1;">  <p style="text-align: center;">↓</p>  <div style="display: flex; justify-content: space-around; margin-top: 10px;"> <div style="text-align: center;"> <p>New specified setting of a RCF value</p> </div> <div style="text-align: center;"> <p>New specified setting of a Sample Height</p> </div> </div> </div> <div style="flex: 0.5; margin-left: 10px;"> <ul style="list-style-type: none"> <li>• The Run screen appears.</li> </ul> </div> </div> <p>○The new specified setting of a RCF value and the new specified setting of a Sample Height are displayed in the above box.</p>

2-3-4 Displaying and Setting g-sec

This section describes how to display and set a g-sec.

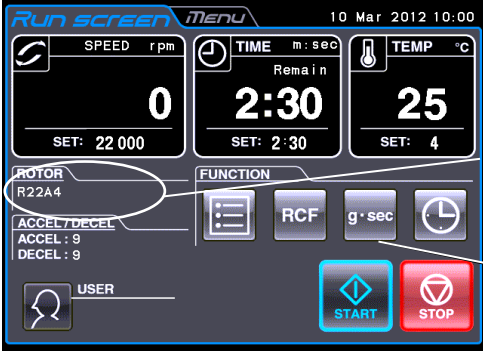
(1) How to display and set a g-sec value

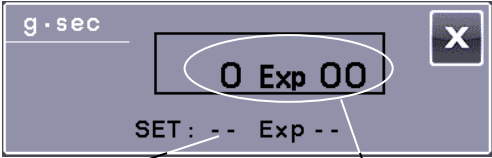
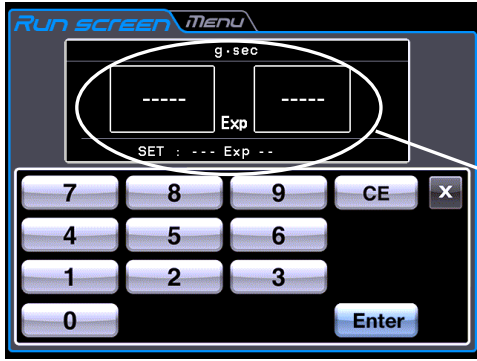
Step	Touch panel operation	Screen displays and notes
1	<p>Check that the desired rotor is displayed in the ROTOR indicator of the Run screen.</p> <p>When the desired rotor is not displayed, press the ROTOR indicator to show the ROTOR CATALOG screen. (For selecting the rotor, refer to section 2-4.)</p>	 <p>ROTOR indicator</p> <p>[g-sec] button</p>
2	<p>In the FUNCTION area of the Run screen, press the  button.</p>	 <ul style="list-style-type: none"> <li>The box (for displaying a g-sec) appears in the FUNCTION area.</li> </ul> <p>Specified setting of a g-sec      Current status of a g-sec      Box for displaying a g-sec</p> <ul style="list-style-type: none"> <li>When there is no rotor name on the ROTOR indicator, even if you press the g-sec button, the above box does not appear.</li> <li>The box for displaying a g-sec displays the current status in the upper part and the specified setting in the lower part.</li> <li>“--Exp--” is displayed when no g-sec value is set.</li> </ul>
3	<p>Press the box (for displaying a g-sec).</p>	 <ul style="list-style-type: none"> <li>Screen for setting a g-sec appears.</li> </ul> <p>Specified setting of a g-sec (Left part) Exponent (Right part) Mantissa</p> <ul style="list-style-type: none"> <li>Specified setting of a g-sec is displayed in the above screen.</li> <li>“--Exp--” is displayed when no g-sec value is set.</li> </ul>

Step	Touch panel operation	Screen displays and notes
4	<p>Press the area of desired item.</p>	<div data-bbox="722 387 1201 745" style="text-align: center;"> </div> <ul style="list-style-type: none"> <li>• The specified setting turns blue.</li> </ul> <p>Color: blue</p> <p>○ If you want to change other settings, press the area of the desired item, and the pressed area will become the input wait state.</p>
5	<p>a) Enter the desired numeric value with the on-screen keypad.</p> <div data-bbox="264 987 608 1122" style="text-align: center;"> </div> <p>Entered numbers are moved to the left every time a new number is entered.</p> <p>e.g.) setting “281exp12”</p> <ul style="list-style-type: none"> <li>• (Left part) Mantissa: <b>[2] [8] [1]</b></li> <li>• (Right part) Exponent <b>[1] [2]</b></li> </ul> <p>b) Press the <b>[Enter]</b> button.</p> <p>Use the <b>[CE]</b> button to cancel input.</p>	<p>e.g.) setting “281exp12”</p> <div data-bbox="683 925 1161 1283" style="text-align: center;"> </div> <p>a) The color of the inputted numeric values is blue.</p> <p>Part for inputting the exponent</p> <p>Part for inputting the mantissa</p> <p>Press the <b>[Enter]</b> button.</p> <div data-bbox="691 1693 1177 2051" style="text-align: center;"> </div> <p>b) The color of the inputted g-sec value turns white.</p>

Step	Touch panel operation	Screen displays and notes
6	Press the <b>[x]</b> button, and then the Run screen reappears.	<div data-bbox="667 376 1150 734" style="border: 1px solid black; padding: 5px;"> </div> <ul style="list-style-type: none"> <li>• The Run screen appears.</li> <li>○ “--:--” is displayed in the lower part of the TIME area by pressing <b>[Enter]</b> button (The elapsed time is displayed in the upper part of the TIME area.)</li> <li>○ The centrifuge starts deceleration when the current status of the g-sec matches the specified setting of the g.sec, and the current status of the g-sec shows the total value until the rotor stops.</li> <li>○ Set the run time in order to clear the operation of the g-sec setting.</li> </ul>

### 2-3-5 RTC (real-time control) Operation

This centrifuge contains an internal clock, allowing you to run the machine at a specified start or finish time for centrifugation. This feature for running the machine at a specified time is called the RTC (real-time control) feature. The feature saves you the trouble of calculating the delay time for “delayed-start operation”.

Explained below is how to perform an RTC operation, with an example.

e.g.) If you wish to install your rotor on the centrifuge under the run conditions listed below on the evening of January 10 and to take out the samples around 8:00 the next morning;

- (1) Rotor: R22A4
- (2) RPM: 22,000 rpm
- (3) Separation time: 60 minutes
- (4) Acceleration mode: 9
- (5) Deceleration mode: 9

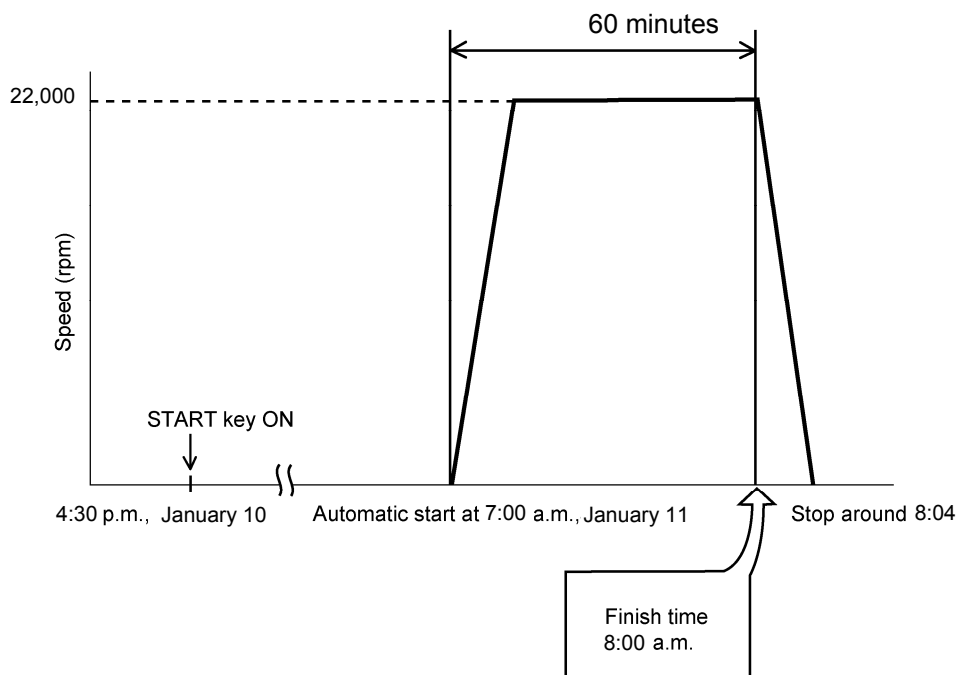

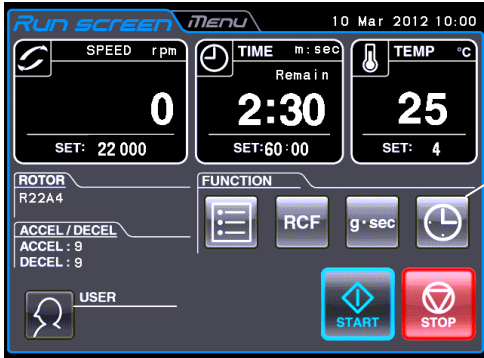
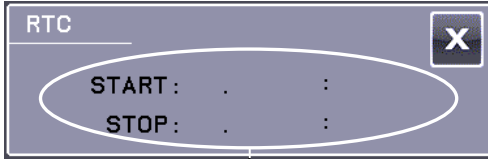
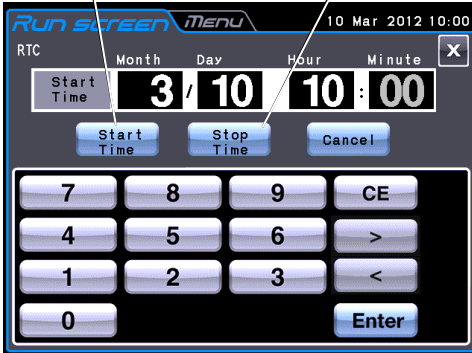

Fig. 2-3-5 A typical RTC Operation

In this example, you set the above run conditions (2) through (5), set the start time for RTC operation to 7:00, January 11 and start the centrifuge.

(You can make an identical setting by setting the finish time to 8:00 instead of setting the start time to 7:00.)



(1) How to perform an RTC operation

Step	Touch panel operation	Screen displays and notes
1	<p>In the Run screen, enter the run parameters.</p> <p>In the FUNCTION area of the Run screen, press the  button.</p>	 <p>[RTC] button</p> <ul style="list-style-type: none"> <li>To specify the run time (centrifugation time), do not set HOLD. Enter the desired numeric value.</li> </ul>
2	<p>Press the box (for displaying RTC).</p>	 <ul style="list-style-type: none"> <li>The box (for displaying RTC) appears in the FUNCTION area.</li> </ul> <p>Box for displaying RTC</p> <p>(Upper part) Start time (Lower part) Stop time</p>
3	<p>If you want to set a run to start on a particular date and time, press the <b>[Start Time]</b> button.</p> <p>If you want to set a run to stop on a particular date and time, press the <b>[Stop Time]</b> button.</p> <p>Enter the start time or stop time with the on-screen keypad.</p>	<p><b>[Start Time]</b> button</p> <p><b>[Stop Time]</b> button</p>  <ul style="list-style-type: none"> <li>Screen for setting RTC appears.</li> <li>You can switch items (Month, Day, Hour, Minute) for entering the numeric value by pressing the <b>[&gt;]</b> button and the <b>[&lt;]</b> button.</li> </ul> <ul style="list-style-type: none"> <li>If you want to change any of the Month, Day, Hour, or Minute setting, press the area of the desired item and enter the numeric value.</li> <li>To set the hours, use a number between 0 and 23 (in the 24-hours system).</li> <li>Enter a time later than the current time. When setting the "stop time", allow for centrifugation time and set the centrifugation start time to a time later than the current time.</li> <li>You cannot set the centrifugation start time to a date more than 20 days in the future.</li> </ul>

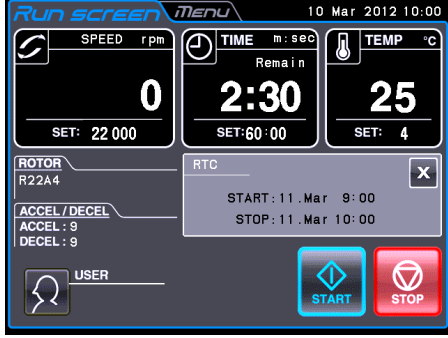
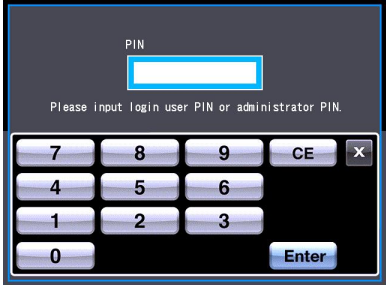

Step	Touch panel operation	Screen displays and notes
4	Press the <b>[Enter]</b> button.	 <ul style="list-style-type: none"> <li>• The START confirmation box appears.</li> </ul>
5	<p>Press the <b>[START]</b> button.</p> <div data-bbox="276 869 647 1032" style="border: 1px solid black; padding: 5px; margin: 10px 0;"> <p>The RTC operation does not get activated unless you press the <b>[START]</b> button.</p> </div> <div data-bbox="276 1070 647 1211" style="border: 1px solid black; padding: 5px; margin: 10px 0;"> <p>If you want to cancel the RTC operation, press the <b>[STOP]</b> button.</p> </div>	 <ul style="list-style-type: none"> <li>○ The START time and STOP time for centrifugation are displayed in the RTC area by pressing the <b>[START]</b> button. This centrifuge will turn the rotor automatically at the specified time.</li> <li>○ Pressing the <b>[START]</b> button enters the system into a condition causing the centrifuge to wait until the set time comes. This centrifuge will turn the rotor automatically at the specified time and run it for the specified time.</li> <li>○ Once the RTC setting is made, you cannot change the run time (centrifugation time). If you wish to make a change to the run time, cancel RTC first. If you want to cancel the RTC, press the <b>[RTC]</b> button in the Run screen and press the <b>[Cancel]</b> button in the screen for setting RTC.</li> <li>○ If you cancel RTC when the user lockout function (see Section 2-6-4 (2) on this function) is enabled, the following screen appears. Inputting the “login user PIN” or the “administrator PIN” is required in this screen.</li> </ul> 

**NOTE**



1. You cannot make an RTC setting in any of the following cases:
  - (1) When the Run screen is set to HOLD (continuous run)  
 Set the run time (centrifugation time) not to HOLD but to a numerical value.
  - (2) When it is past the start time  
 Set the start time to a time later than the current time.
  - (3) When the start time is more than 20 days after the current time  
 Set the time to a time no more than 20 days afterwards.
2. To change the run time (centrifugation time) after making an RTC setting, cancel RTC and then set a new run time.
3. To perform a combination of a programmed operation (including a step-mode operation) with an RTC run, call a program, then set RTC.  
The system calculates the total run times of all steps of the programmed operation and calculates the start time for RTC.  
Therefore, cannot call the program after setting RTC.
4. To stop this centrifuge in RTC operation, press the **[STOP]** button. The system then stops RTC and stops the rotor.

## 2-4 Selecting the Rotor

This centrifuge stores the maximum and average radii of each rotor in the internal memory. Setting a speed causes this centrifuge to automatically calculate and display the RCF (relative centrifugal force) value, while setting an RCF value causes the centrifuge to automatically calculate and display the speed.

You can control the rotor data such as total operation hours and number of runs by registering your rotors in the centrifuge.

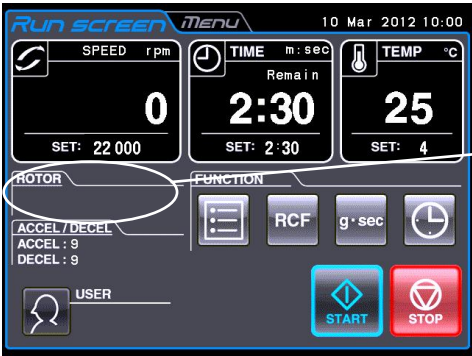
### (1) Procedure for selecting the rotor

Step	Touch panel operation	Screen displays and notes
1	<p>Check that the desired rotor is displayed in the ROTOR indicator of the Run screen. When the desired rotor is not displayed, press the ROTOR indicator.</p>	 <p>ROTOR indicator</p>
2	<p>Check whether the desired rotor is displayed in the Rotor Management screen or not. When the desired rotor is displayed, press the row of the desired rotor and press the [OK] button.</p>	 <ul style="list-style-type: none"> <li>• The Rotor Management screen appears.</li> <li>• Nothing is displayed in the ROTOR indicator by pressing the [Cancel] button.</li> </ul> <p>○ You can select your rotor in the Rotor Management screen, if you registered your rotor in advance (see Section 2-6-4 (4) “Rotor Management”).</p> <p><b>⚠ CAUTION:</b> If you have selected your rotor in the Rotor Management screen, be sure to check that the selected rotor (in the Rotor Management screen) and the rotor which is installed in the centrifuge have an identical serial number. The serial number of the selected rotor is shown in the Rotor Management screen, and also the ROTOR indicator of the Run screen. If the serial number of the selected rotor (in the Rotor Management screen) is different from the serial number of the rotor which is installed in the centrifuge, you can not control the total operation hours of both rotors and the total number of runs of both rotors.</p>

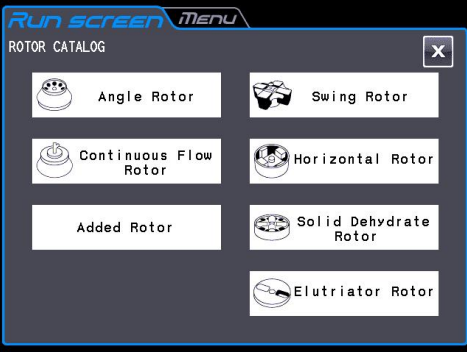
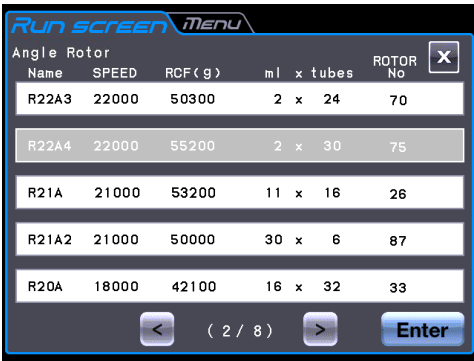
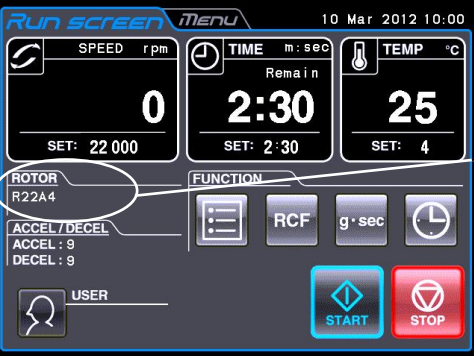

Step	Touch panel operation	Screen displays and notes
3	<p>When the desired rotor is not displayed, press the <b>[Rotor Catalog]</b> button.</p> <p>In the ROTOR CATALOG screen, press the field of the desired rotor type.</p>	 <ul style="list-style-type: none"> <li>The ROTOR CATALOG screen appears.</li> </ul>
4	<p>In the screen for selecting the rotor, press the row of the desired rotor. Check that the pressed row turns blue and press the <b>[Enter]</b> button.</p>	 <ul style="list-style-type: none"> <li>The screen for selecting the rotor appears.</li> <li>The pressed row turns from white to blue.</li> </ul>
5	<p>The desired rotor is displayed in the ROTOR indicator of the Run screen.</p>	 <ul style="list-style-type: none"> <li>The Run screen reappears.</li> <li>ROTOR indicator</li> </ul>

- NOTE**
- (1) Selecting the rotor is required to display and set an RCF value (see Section 2-3-3 “Displaying and Setting RCF”).
  - (2) You can select your rotor in the Rotor Management screen, if you registered your rotor in advance (see Section 2-6-4 (4) “Rotor Management”).

## 2-5 User Login

After logging in, individual users can control the operation history of the centrifuge.

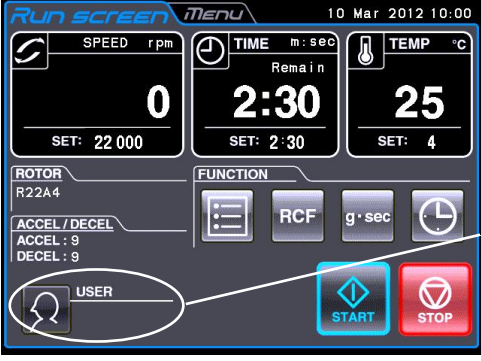
(1) Procedure for user login

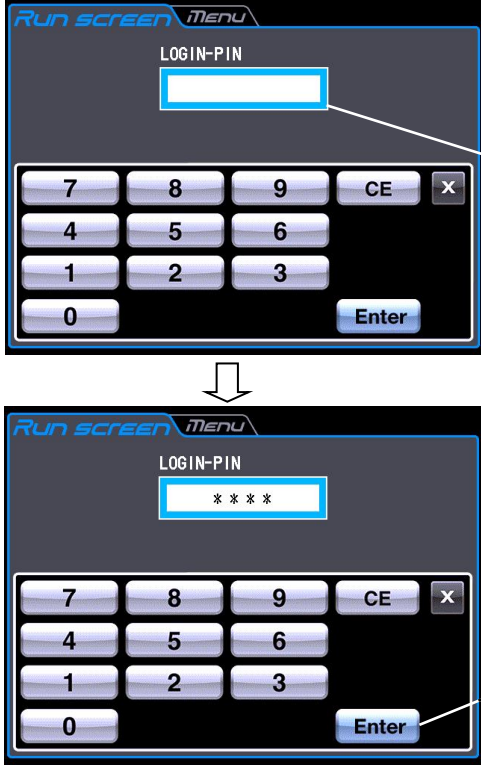
Step	Touch panel operation	Screen displays and notes
1	In the Run screen, press the USER area.	 <p style="text-align: right;">USER area</p>
2	In the User Management screen, press the row of the desired user name, and make sure that the pressed row turns blue. Then press the <b>[LOGIN]</b> button. (“Admin” was registered as a user name for this centrifuge before shipment.)	 <ul style="list-style-type: none"> <li>• The User Management screen appears.</li> <li>The pressed row turns from white to blue.</li> <li><b>[LOGIN]</b> button</li> </ul>
3	<p>Enter the desired PIN on the on-screen keypad and press the <b>[Enter]</b> button.</p> <p>PIN is the number (4 digits) which you entered on the PIN registration screen (see Section 2-6- 4 (1)).</p> <p>(“1111” is the PIN of “Admin” registered as a user name for this centrifuge before shipment. If necessary, change the PIN.)</p>	 <ul style="list-style-type: none"> <li>• The Login screen appears.</li> <li>PIN field</li> <li>• The masked PIN is displayed.</li> <li><b>[Enter]</b> button</li> </ul>

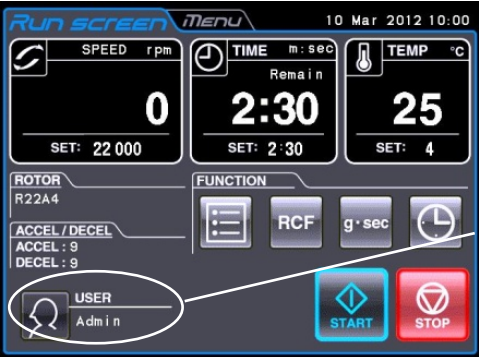
Step	Touch panel operation	Screen displays and notes
4	The user name is displayed in the USER area of the Run screen.	 <p>• Run screen reappears.</p> <p>USER area</p>

**NOTE** (1) User login is required to start operation when the user lockout function has been enabled as described in Section 2-6-4 (2) "User Lockout" You cannot operate the centrifuge without logging in. Perform registration according to Section 2-6-4 (1) "User Management" before attempting to log in.

## 2-6 Features of the MENU Screen

The Menu screen appears by pressing the MENU screen tab on the Touchscreen. These features are designed to allow you to use this centrifuge with additional handy options (see figure 2-6).

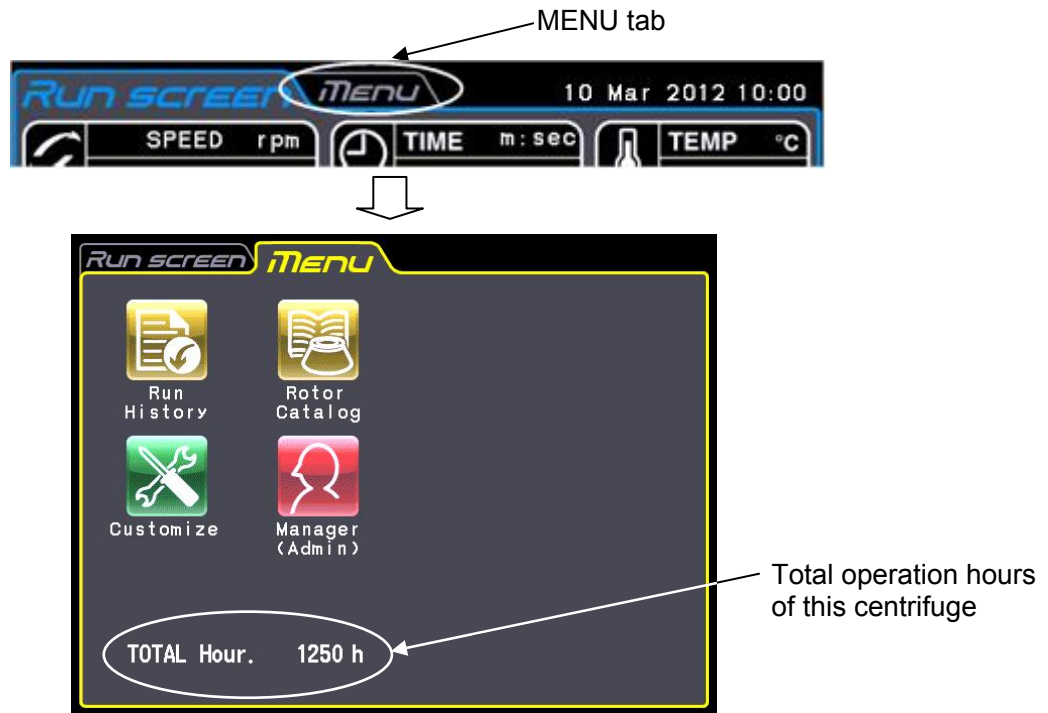





Fig. 2-6 MENU Screen

The functions of each icon on the MENU screen are described in the table below.

Function	Icon	Description
Run History		The information about 100 sets of the run parameters of the previous normal operations can be stored automatically in the centrifuge (see Section 2-6-1 “Displaying the Run History and Loading the Information About Run Parameters”).
Rotor Catalog		You can view the applicable rotor names and their specifications (see Section 2-6-2 “Rotor catalog”).
Customize		You can select rotor stop signal etc. which enable you to easily run the centrifuge (see Section 2-6-3 “Customizing the settings”).
Manager (Admin)		You can set the items which the administrator should set such as language (see Section 2-6-4 “Administrator (Admin) functions”).

Press the desired icon. Then the corresponding item is displayed.

2-6-1 Displaying the Run History and Loading the Information About Run Parameters

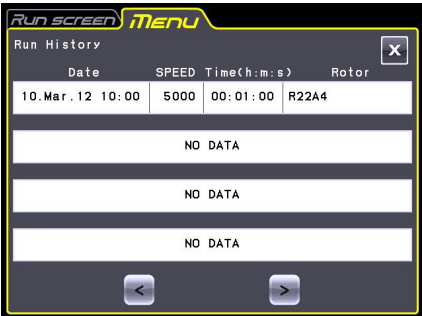
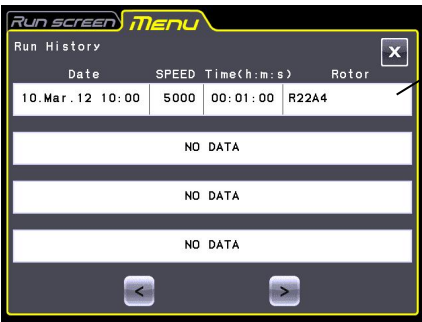
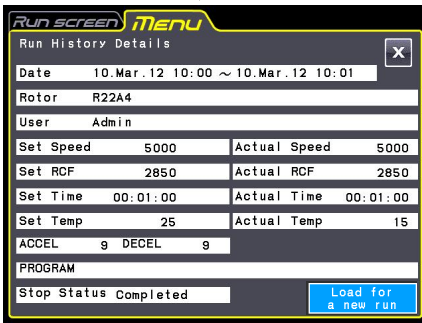

The information about 100 sets of the run parameters of the previous normal operations can be stored automatically in the centrifuge and you can load it for a new run.

Step	Touch panel operation	Screen displays and notes
1	Press the <b>[Run History]</b> icon in the MENU screen.	 <ul style="list-style-type: none"> <li>• The Run History screen appears.</li> </ul>
2	If you want to check the details of the information about run parameters of the operation, press the row of the information which you want to check the details about.	 <p>If you press this row, the following screen appears.</p>  <ul style="list-style-type: none"> <li>• The Run History Details screen appears.</li> </ul>
3	If you want to load the information about run parameters for a new run, press the <b>[Load for a new run]</b> button.	<ul style="list-style-type: none"> <li>○ The loaded run parameters are displayed in the Run screen.</li> </ul>
	If you need not to load the information about run parameters for a new run, press the Run screen tab to return to the Run screen.	<ul style="list-style-type: none"> <li>○ The Run screen reappears.</li> </ul>



## 2-6-2 Rotor Catalog

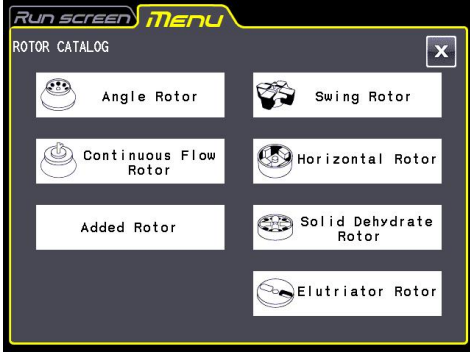
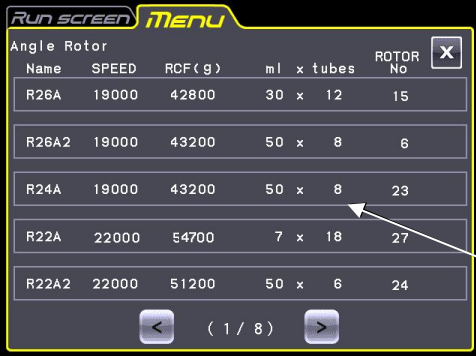

You can view the applicable rotor names and their specifications.

Step	Touch panel operation	Screen displays and notes
1	Press the [ <b>Rotor Catalog</b> ] icon in the MENU screen.	 <ul style="list-style-type: none"> <li>• The ROTOR CATALOG screen appears.</li> </ul>
2	Press the field of the desired rotor type in the ROTOR CATALOG screen.  [<] : Previous Page button [>] : Next Page button	 <ul style="list-style-type: none"> <li>• The screen for displaying the rotor specifications appears.</li> </ul> <p>ml x Number of tubes</p>
3	If you want to view the MENU screen, press the [ <b>x</b> ] button or MENU screen tab.  If you want to view the Run screen, press the Run screen tab.	<ul style="list-style-type: none"> <li>○ The MENU screen appears.</li> <li>○ The Run screen appears.</li> </ul>

2-6-3 Customizing the Settings



You can customize the settings in the Run screen and the settings in the CUSTOM screen such as the stop signal, sound volume and backlight.

In the MENU screen, press the **[Customize]** icon. Then the CUSTOM screen showing the six functions is displayed as shown in Fig. 2-6-3.

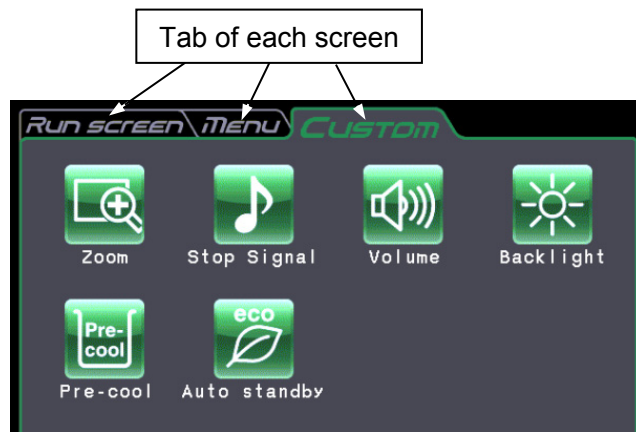







Fig. 2-6-3 CUSTOM Screen

The functions of each icon in the CUSTOM screen are described in the table below.

Function	Icon	Description
Zoom		The display in the Run screen can be zoomed in (see Section 2-6-3 (1)).
Stop signal		The rotor stop signal can be selected from six kinds of sound including five tunes and electric beep (see Section 2-6-3 (2) ).
Volume		The volume of the stop signal can be adjusted (see Section 2-6-3 (3)).
Brightness		The brightness of the screen can be adjusted (see Section 2-6-3 (4)).
Pre-cool		Pre-cool can be selected (see Section 2-6-3 (5)).
Auto standby		Auto standby mode can be selected (see Section 2-6-3 (6)).

Press the desired icon. Then the corresponding item is displayed. After setting, press the tab of the desired screen.

## (1) Zoom



The display on the Run screen can be zoomed in.

1. Normal: Displays the ordinary Run screen
2. Zoom: The speed and time display is zoomed when 20 seconds have passed after reaching the set speed.

Press either the **[NORMAL]** or **[ZOOM]** button and make sure that the selected button is surrounded with a green frame.

Then press the **[x]** button or the CUSTOM tab to store the setting.

To return from the zoom screen to the normal screen during operation, press anywhere except the **[STOP]** button. Then the screen returns to the normal screen.

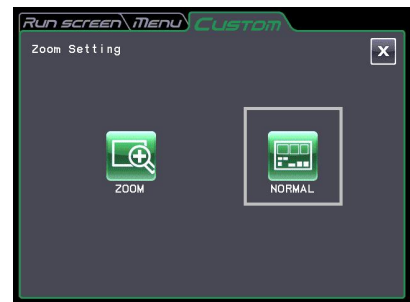

Fig. 2-6-3 (1) Zoom Setting screen

## (2) Stop signal



The rotor stop signal can be selected from six kinds of sound including five tunes and electric beep.

Press the row of the desired stop signal. Then the stop signal sounds and the row of the selected stop signal turns blue.

Press the **[Enter]** button to store the setting.

To set another function in the CUSTOM screen, press the **[x]** button or the CUSTOM tab.



Fig. 2-6-3 (2) Stop signal Setting screen

## (3) Volume Adjustment



The sound volume can be adjusted.

The sound volume is turned up as the green range in the volume setting indicator increases. The sound volume is the minimum (zero) if there is only the black range. Adjust the sound volume by pressing the following buttons.





-  The volume is lowered by pressing this button.
-  The volume is turned up by pressing this button.
-  The sound volume is the minimum (zero) by pressing this button.
-  The sound volume is the maximum by pressing this button.



Fig. 2-6-3 (3) Volume Setting screen

Press the **[x]** button or the CUSTOM tab to store the setting.

(4) Backlight setting



The brightness of the screen can be adjusted. Dimming backlight mode can be specified.

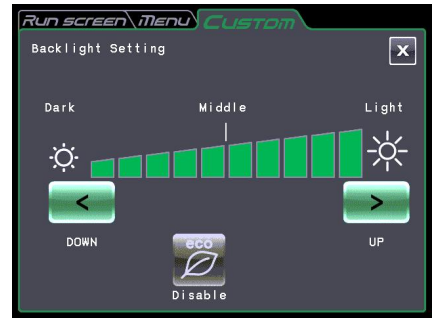

Fig. 2-6-3 (4) Backlight Setting screen

① Adjusting the brightness

The backlight brightens up as the green range in the backlight setting indicator increases. The backlight level is darkest if there is only the black range.

Press the following buttons to adjust the brightness of the screen. Press the [x] button or the CUSTOM tab to store the setting.



The brightness is decreased by pressing this button.



The brightness is increased by pressing this button.

② Setting the dimming backlight mode

When the dimming backlight mode is not selected, if you press the button, you can select the dimming backlight mode.

When the dimming backlight mode is selected, if you press the button, you can cancel the dimming backlight mode.



Fig. 2-6-3 (5) Button for indicating that the dimming backlight mode is not selected



Fig. 2-6-3 (6) Button for indicating that the dimming backlight mode is selected

- When the dimming backlight mode is selected, if you do not press any places on the screen for a specified time, the backlight level becomes darkest. If you press any places on the screen after the backlight level becomes darkest, the backlight level becomes the brightness which you adjusted (see section 2-6-3 (4) ①).

When the dimming backlight mode is selected, you can set the followings.

- If you want to dim the backlight while the rotor is not spinning, press the “Dim only during stopping” (see fig. 2-6-3 (6)).  
If you want to dim the backlight while the rotor is not spinning and while the rotor is spinning at the set speed, press the “Dim even during operation” (see fig. 2-6-3(6)).
- If you want to set the dimming backlight time, press the min. button. The Dimming backlight time setting screen appears (see fig. 2-6-3 (7)) . You can enter the desired numeric value with the on-screen keypad . You can set to any value in the range from 1 minute to 180 minutes in increment of 1 minute.

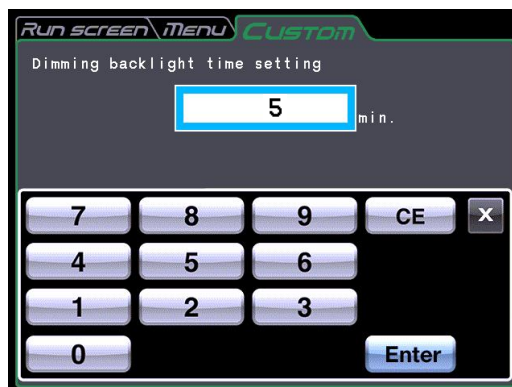

Fig. 2-6-3 (7) Dimming backlight time setting screen

## (5) Pre-cool setting



Pre-cool can be specified.

The temperature in the rotor chamber is controlled at about 15 °C by selecting “Pre-cool”. Presence of a rotor is automatically detected when closing the door and the temperature in the rotor chamber is controlled at about 15 °C if no rotor is mounted and the set temperature is below 15 °C. (It is controlled at the set temperature when a rotor is mounted. The temperature in the rotor chamber may not be controlled if the ambient temperature or the temperature of the rotor chamber is below 15 °C.

Press the **[Enable]** button if you want to select the Pre-cool.

Press the **[Disable]** button if you do not need to select the Pre-cool.

Make sure that the selected button is surrounded with a green frame, and then press the **[x]** button or the CUSTOM tab to store the setting.

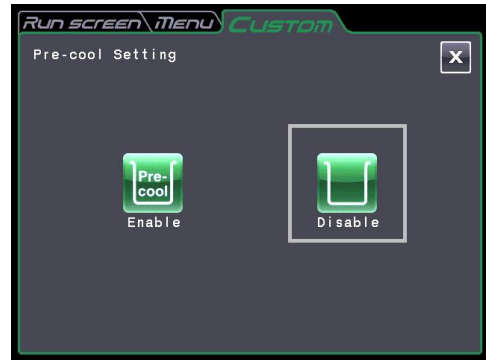

Fig. 2-6-3 (8) Pre-cool Setting screen

## (6) Auto standby setting



Auto standby can be specified.

- When the Auto standby is selected, if you do not press any places on the screen for a specified time while the rotor is not spinning, the backlight level becomes darkest and then the refrigerator and fan stop.
- This can lower the electric power consumption of the centrifuge (\*1). (\*1: When the backlight level becomes darkest, the refrigerator and fan might not stop soon. If the room is hot, the fan might start to cool the inside of the centrifuge.)
- If you press any places on the screen after the backlight level becomes darkest, the backlight level becomes the brightness which you adjusted (see section 2-6-3 (4)) and then the refrigerator and fan can start.
- When the Auto standby is selected, press the **[5 min.]** button. The Auto standby timeout setting screen appears (see fig. 2-6-3 (11)). You can enter the desired numeric value with the on-screen keypad. You can set to any value in the range from 1 minute to 180 minutes in increment of 1 minute.

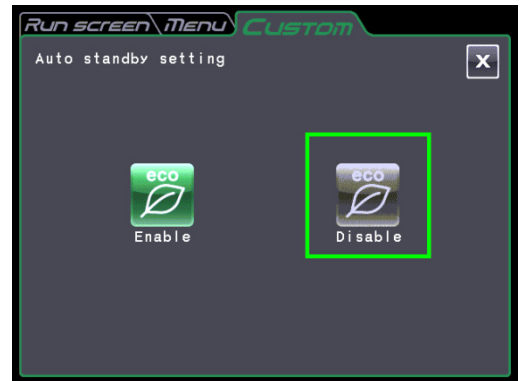

Fig. 2-6-3 (9) Auto Standby Setting screen

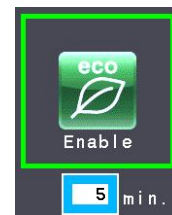

Fig. 2-6-3 (10) Button for indicating that Auto Standby Setting is selected



Fig. 2-6-3 (11) Auto standby timeout setting

2-6-4 Administrator (Admin) Functions



You can set the administrative items such as language mainly.

In the MENU screen, press the **[Manager(Admin)]** icon. Then the ADMIN screen showing the nine functions is displayed as shown in Fig. 2-6-4.

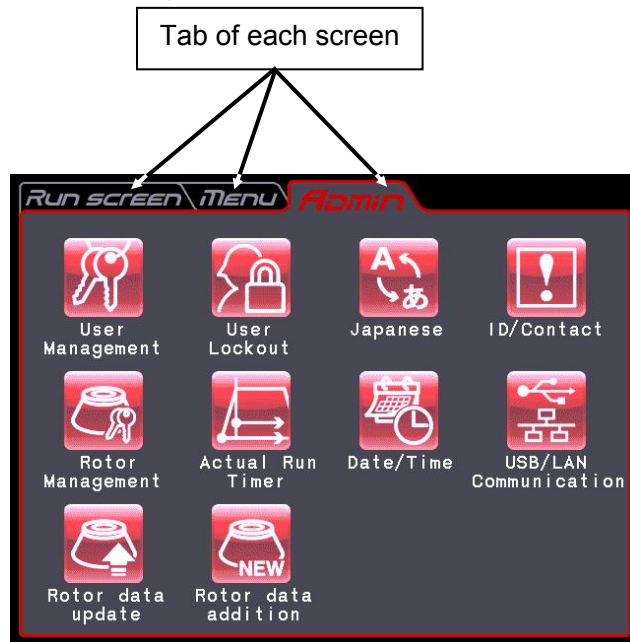



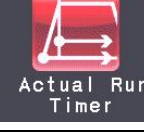
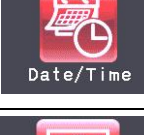
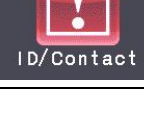



Fig. 2-6-4 ADMIN Screen

The functions of each icon on the ADMIN screen are described in the table below.

Function	Icon	Description
User Management		The user name can be registered and deleted (see Section 2-6-4 (1)).
User Lockout		User login can be required to start operation (see Section 2-6-4 (2)).
Language		English and Japanese can be toggled in display (see Section 2-6-4 (3)).
Rotor Management		You can use and control the rotor data such as total operation hours and number of runs (see Section 2-6-4 (4)).
Actual Run Timer		Actual run timer can be selected (see Section 2-6-4 (5)).
Date and time display		The date and the time can be set (see Section 2-6-4 (6)).
Centrifuge ID Service contact		Centrifuge ID can be set for identification (see Section 2-6-4 (7)).
USB/LAN(option) communication		The operation history data of the centrifuge can be exported to a USB flash drive. (CR22N only) If your centrifuge has a LAN communication option, LAN communication start/stoppage can be specified. (see Section 2-6-4 (8)).
Rotor data addition		New rotor can be registered (see Section 2-6-4 (9)).

Press the desired icon. Then the corresponding item is displayed. After setting, press the tab of the desired screen.



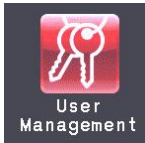

(1) User Management



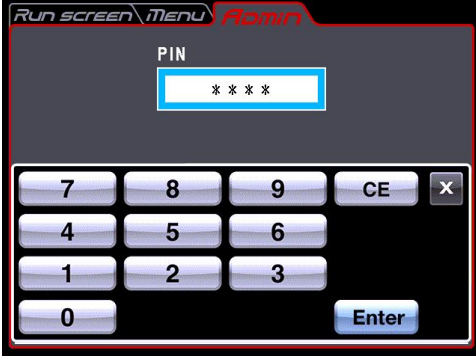

You can register up to 40 users with the system.  
How to store (register) and how to change a user name are described below.

Step	Touch panel operation	Screen displays and notes
	<p>Press the <b>[User Management]</b> icon. Then press the <b>[Add User]</b> button.</p> <p>(“Admin” whose PIN is “1111” has been registered in this centrifuge before shipment. If necessary, change the PIN.)</p>	<div data-bbox="687 600 1166 958"> </div> <ul style="list-style-type: none"> <li>The User Management screen appears.</li> </ul> <p style="text-align: center;">↓</p> <div data-bbox="687 1115 1166 1473"> </div> <ul style="list-style-type: none"> <li>A screen to register a user name is displayed.</li> </ul> <p> <b>[Clear]</b> button      <b>[Space]</b> button      <b>[Enter]</b> button  <b>[Shift]</b> button      <b>[Delete]</b> button         </p> <ul style="list-style-type: none"> <li>Press the <b>[Shift]</b> button to toggle case.</li> <li>Press the <b>[Clear]</b> button to delete all the characters in the user name box.</li> <li>Press the <b>[Space]</b> button to put one space after the last character in the user name box.</li> <li>Press the <b>[Delete]</b> button to delete the last character in the user name box.</li> <li>Press the <b>[Enter]</b> button to turn the screen to the PIN registration screen.</li> <li>Press the <b>[x]</b> button to return to the user administration screen.</li> </ul>

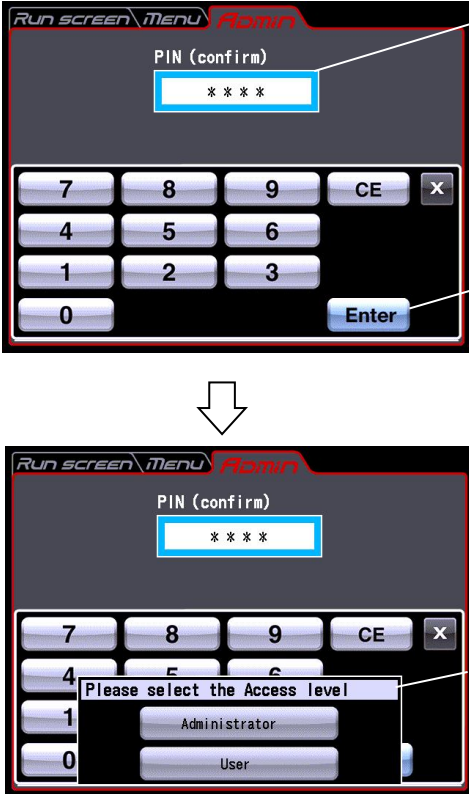

Step	Touch panel operation	Screen displays and notes
2	Register the user name and press the <b>[Enter]</b> button.	 <p><b>[Enter]</b> button</p> <p>↓</p>  <p>PIN box</p> <ul style="list-style-type: none"> <li>• The PIN registration screen is displayed.</li> </ul>
3	Enter the desired PIN number (4 digits) in the PIN box and press the <b>[Enter]</b> button.	 <ul style="list-style-type: none"> <li>• The masked PIN number is displayed.</li> </ul> <p>↓</p>  <ul style="list-style-type: none"> <li>• The PIN confirmation screen is displayed.</li> </ul>

Step	Touch panel operation	Screen displays and notes
<p>4</p>	<p>Enter the same PIN number (4 digits) as the one entered in the above step 3 in the PIN (confirm) box. Press the <b>[Enter]</b> button.</p> <p>Difference of access level                      Admin: The administrator can do every operation of this centrifuge.                      User: The user cannot use the Admin functions when the user lockout function is enabled.</p> <p>For the the user lockout function, refer to Section 2-4-6 (2).</p>	 <p>PIN (confirm) box</p> <ul style="list-style-type: none"> <li>The masked PIN number is displayed.</li> </ul> <p><b>[Enter]</b> button</p> <p>↓</p> <ul style="list-style-type: none"> <li>The access level selection box is displayed.</li> </ul> <p>Access level selection box</p>
<p>5</p>	<p>To place the registered user on the same access level with the administrator, press <b>[Administrator]</b> in the access level selection box. If you do not want to place the registered user on the same access level with the administrator, press <b>[User]</b> button.</p> <p>(The screen display shows the case when placing the registered user on the same access level with the administrator.)</p>	 <ul style="list-style-type: none"> <li>The screen returns to the User Management screen. "P. Johnson" is added to the user name and "Administrator" is displayed as the access level.</li> </ul> <p><b>[Access level]</b> button      <b>[PIN]</b> button</p> <ul style="list-style-type: none"> <li>To change the access level or the PIN number after registration of the user name, press the row of the desired user name and check that the row turns blue. Press the <b>[Access level]</b> button or the <b>[PIN]</b> button to make a change.</li> <li>To delete the user name after registration, press the row of the desired user name and check that the row turns blue. Press the <b>[Delete User]</b> button to delete it.</li> </ul>

## (2) User Lockout



**[Enable]** : User login is required to start operation.  
 You can not set run conditions and start operation without logging in. Prior user registration is required.

(See Section 2-6-4 (1) "User Management" and 2-5 "User login".)

In addition, login of a user having the administrator access level is required to call up the Admin screen.)

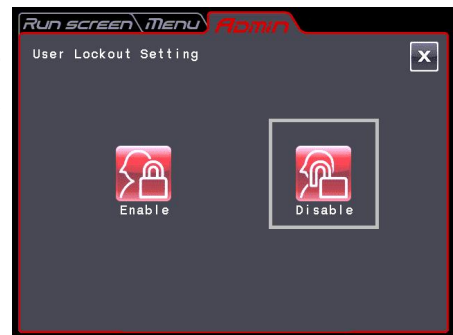

Fig. 2-6-4 (1) User Lockout Setting Screen

**[Disable]** : User login is not required to start operation.

Press either the **[Enable]** or **[Disable]** button and make sure that the selected button is surrounded with a red frame.

Then press the **[x]** button or the ADMIN tab to store the setting.

## (3) Language



You can select whether to give displays in English or Japanese by pressing this button.



(4) Rotor Management





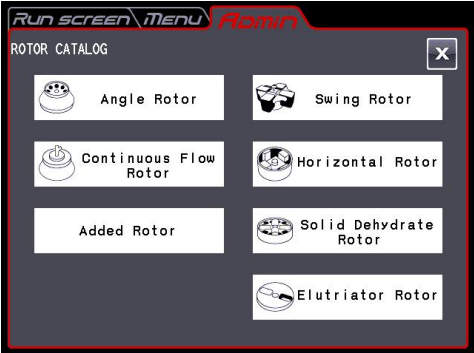
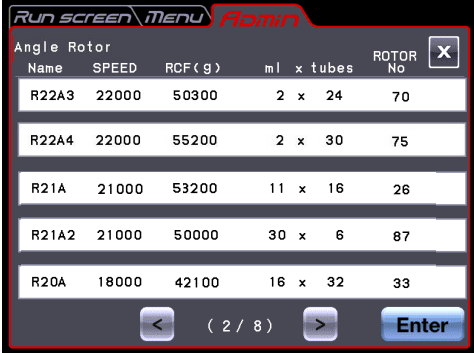

You can use and control the rotor data such as total operation hours and number of runs by registering your rotors in the centrifuge in advance.

1) Registering the rotor



Step	Touch panel operation	Screen displays and notes
1	<p>Register the rotor as follows:</p> <p>a) In the ADMIN screen, press the <b>[Rotor Management]</b> icon.</p> <p>b) Press the <b>[Add rotor]</b> button.</p> <p>c) In the ROTOR CATALOG screen, press the field of the desired rotor type</p> <p>d) Press the row of the desired rotor name and press the <b>[Enter]</b> button.</p>	<p>a) The Rotor Management screen appears.</p>  <p>b) The ROTOR CATALOG screen appears.</p>  <p>c) The screen for selecting the rotor appears.</p> 

Step	Touch panel operation	Screen displays and notes
1	<p>e) Enter the S/N (Serial number ) and press the <b>[Enter]</b> button.</p> <p>Registration is completed if it is a new rotor having no operation history. Proceed to step 4.</p>	<div style="display: flex; align-items: flex-start;"> <div style="flex: 1;">  </div> <div style="flex: 1; padding-left: 10px;"> <p>d) The Enter S/N screen appears.</p> <ul style="list-style-type: none"> <li>• Enter a 4-digit number: In the case of "123," prefix zero to the number ("0123").</li> </ul> </div> </div> <p style="text-align: center; margin: 10px 0;">↓</p> <div style="display: flex; align-items: flex-start;"> <div style="flex: 1;">  </div> <div style="flex: 1; padding-left: 10px;"> <p>e) The Rotor Management screen reappears.</p> </div> </div>

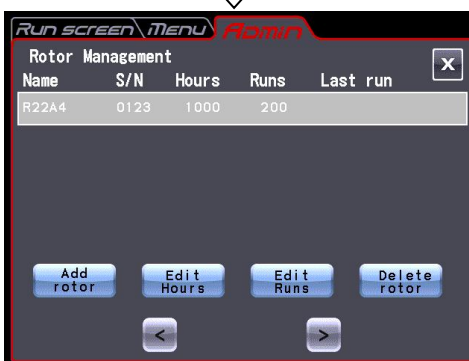
Step	Touch panel operation	Screen displays and notes
2	<p>Enter the total operation hours of the rotor as follows:</p> <p>a) In the Rotor Management screen, press the row of the rotor you want to select, and make sure that the pressed row turns blue. Then press the <b>[Edit Hours]</b> button.</p> <p>b) Using the on-screen keypad, enter the total operation hours of the rotor and press the <b>[Enter]</b> button.</p>	<div style="display: flex; flex-direction: column; align-items: flex-start;"> <div style="display: flex; align-items: flex-start; margin-bottom: 10px;">  <div style="margin-left: 10px;"> <p>● The total number of runs of a rotor having operation history can be registered. This operation is not required for a new rotor.</p> </div> </div> <div style="text-align: center; margin-bottom: 10px;">↓</div> <div style="display: flex; align-items: flex-start; margin-bottom: 10px;">  <div style="margin-left: 10px;"> <p>a) The screen for entering the total operation hours of the rotor appears.</p> </div> </div> <div style="text-align: center; margin-bottom: 10px;">↓</div> <div style="display: flex; align-items: flex-start;">  <div style="margin-left: 10px;"> <p>b) The Rotor Management screen reappears.</p> </div> </div> </div>

Step	Touch panel operation	Screen displays and notes
<p>3</p> <p>Enter the total number of runs of the rotor as follows:</p> <p>a) In the Rotor Management screen, make sure that the row of the rotor you want to select is blue. Then press the <b>[Edit Runs]</b> button.</p> <p>b) Using the on-screen keypad, enter the total number of runs of the rotor and press the <b>[Enter]</b> button.</p>	<p>a) The screen for entering the total number of runs of th rotor appears.</p> <p>b) The Rotor Management screen reappears.</p>	<p>● The total number of runs of a rotor having operation history can be registered. This operation is not required for a new rotor.</p>  <p style="text-align: center;">↓</p>  <p style="text-align: center;">↓</p> 
<p>4</p>	<p>Press the Run screen tab.</p>	<p>● The Run screen appears.</p>

2) Deleting a registered rotor

Step	Touch panel operation	Screen displays and notes
1	In the ADMIN screen, press the <b>[Rotor Management]</b> icon.	 <p>● The Rotor Management screen appears.</p>
2	In the Rotor Management screen, press the row of the rotor which you want to delete, and make sure that the pressed row turns blue. Then press the <b>[Delete rotor]</b> button.	 <p>● The deletion confirmation box is displayed.</p>
3	Press the <b>[YES]</b> button on the deletion confirmation box.	 <p>● The registered rotor is deleted.</p>



(5) Actual Run Timer setting



Actual Run Timer



Enable

<Actual Run Timer is enabled.>

When you press the **[Enable]** button, the timer starts counting after reaching the set speed.



Disable

<Actual Run Timer is not enabled.>

When you press the **[Disable]** button, the timer starts counting immediately after the start of operation.

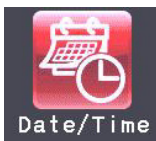

Fig. 2-6-4 (2) Actual Run Timer Setting screen

Press either the **[Enable]** or **[Disable]** button and make sure that the selected button is surrounded with a red frame.

Then press the **[x]** button or the ADMIN tab to store the setting.

(6) Date and time



Date/Time

Use this function to precisely set the current time setting of the internal clock. Set an exact date and time for RTC operation.

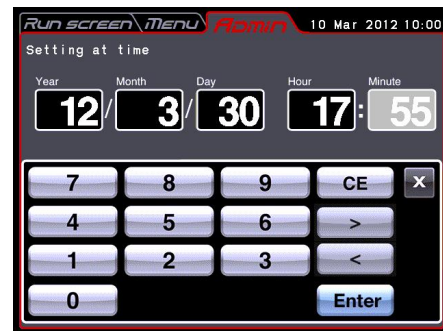

Fig. 2-6-4 (3) Setting at Time screen

Press the area of the desired item (Year, Month, Day, Hour, or Minute), and make sure that the pressed area turns red. Then enter the date and time using on-screen keypad.

If you want to change the other items, press the area of the other items.

You can also turn the desired area to red by pressing the **[ > ]** button and **[ < ]** button.

If you do not want to change the other items, press the **[Enter]** button on the on-screen keypad.

Example:

Year:2012  
 Month:March  
 Day:30th  
 Time:5:55pm

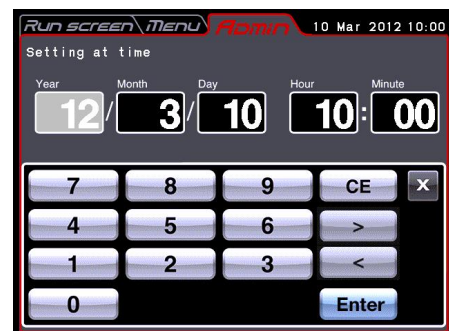
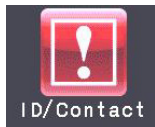

Fig. 2-6-4 (4) Setting at Time screen

If you want to change the setting of the other items in the ADMIN screen, press the ADMIN tab.

(7) ID /Contact



When you have two or more centrifuges, you can set the centrifuge ID for each centrifuge for identification.

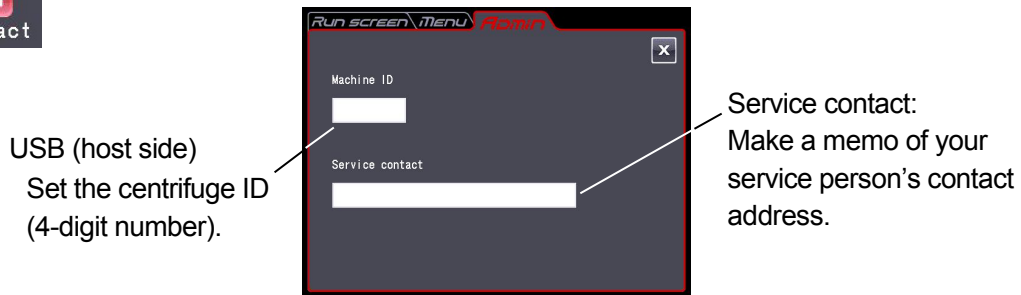

Fig. 2-6-4 (5) Centrifuge ID and Service Contact Setting screen

Press the Machine ID field.



Press the Service contact field.

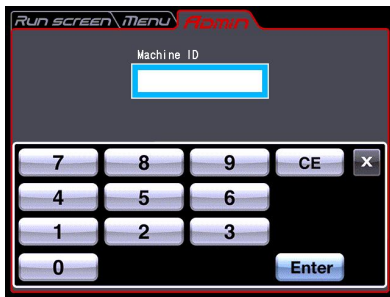

Fig. 2-6-4 (6) Enter Centrifuge ID screen



Fig. 2-6-4 (7) Enter Service Contact screen

(8) USB/LAN communication



[USB MEMORY] (CR22N only)

The operation history of the centrifuge can be output in CSV format\* to a USB flash drive on the market.

\*CSV format: This is a versatile file format that is compatible with spreadsheet softwares.

USB (host side) port

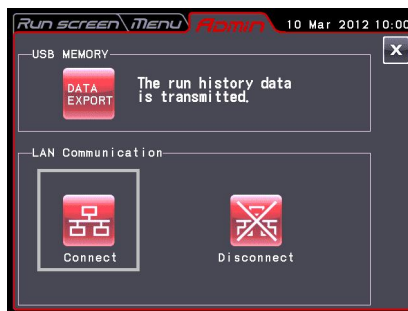
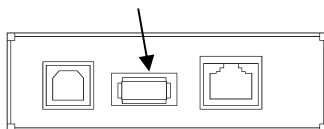

Press the DATA EXPORT button.  
(Writing in the USB flash drive is automatically started.)

Fig. 2-6-4 (8) USB/LAN Communication Setting Screen

**NOTE** (1) After writing in the USB flash drive is finished, the following screen appears.

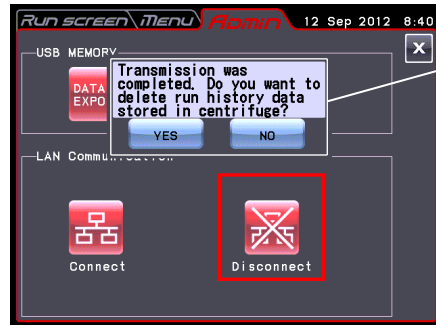

The following message is displayed.  
“Transmission was completed. Do you want to delete run history data stored in centrifuge?”

- If you press the **[YES]** button, the run history data stored in the centrifuge is deleted.  
If you press the **[NO]** button, the run history data stored in the centrifuge is not deleted.  
However, if the information about 100 sets of the run parameters of the previous normal operations has been stored in the centrifuge, the oldest information of the run parameters is deleted when you perform the centrifuge run.
- (2) Be sure to back up your data before using the USB flash drive. We will not be liable for any data loss.
  - (3) This centrifuge cannot use the USB flash drive with security function.
  - (4) When powered on with the USB flash drive, the centrifuge may not recognize the USB flash drive. In such a case, pull out the USB flash drive from the centrifuge and then insert it again into the centrifuge.

#### [LAN Communication] (option)

If your centrifuge has a LAN communication option, LAN communication start/stoppage can be specified. Insert the LAN cable into the LAN port at the right side of the centrifuge.

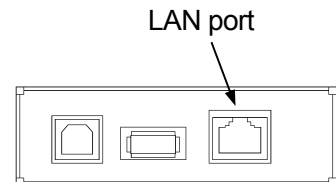

#### **[Connect]:** LAN communication starts.

Press this button to establish the communication between “himac LogManager” (option) on your computer and your centrifuge. It is possible to manage operation results of this centrifuge by using “himac LogManager” (option). If you press this button, either of the below icons is displayed in the left side of the **[START]** button of the Run screen.



:There is no problem in communication between “himac LogManager” (option) on your computer and your centrifuge.



:There might be problems in communication between “himac LogManager” (option) on your computer and your centrifuge. Follow the below instructions.

- Check whether the LAN cable is connected to the centrifuge properly.
- Check whether the “himac LogManager” on your computer is started.
- Check whether the LAN works properly.

#### **[Disconnect]** : LAN communication stops.





**NOTE** Even if your centrifuge does not have a LAN communication option, the **[Connect]** button is surrounded with a red frame as you press the **[Connect]** button. In that case, this icon  is always displayed in the Run screen, but there is no problem.

(9) Rotor data addition





In order to use a new rotor which is not registered in this centrifuge, you can register the information about a new rotor in this centrifuge. You can register the information about ten rotors.

1) Registering the rotor



Step	Touch panel operation	Screen displays and notes
1	<p>Register the rotor as follows:</p> <p>a) In the ADMIN screen, press the <b>[Rotor data addition]</b> icon.</p> <p>b) Press the row you want to add the rotor, and then press the <b>[Add]</b> button.</p>	 <ul style="list-style-type: none"> <li>• The Rotor data addition screen appears.</li> </ul> <p style="text-align: center;">↓</p>  <p style="text-align: right;">Press the row.</p>
2	<p>Input the rotor registration data in the field No.1-No.20.</p> <p><b>NOTE</b></p> <p>For the rotor registration data, contact an authorized sales or service representative.</p> <p><b>[ &lt; ]</b> : Previous Page button  <b>[ &gt; ]</b> : Next Page button</p>	 <ul style="list-style-type: none"> <li>• The Input item screen appears.</li> </ul> <p style="text-align: center;">↻</p> 

Step	Touch panel operation	Screen displays and notes
3	Press the field which you want to input the rotor registration data in.	<div data-bbox="651 371 1157 748" data-label="Image"> </div> <p data-bbox="890 763 938 819">↓</p> <ul data-bbox="655 842 1401 936" style="list-style-type: none"> <li>• A screen to input the rotor registration data is displayed. e.g.) If you press the field No.1, the screen to input the rotor registration data of the field No.1 is displayed (see below).</li> </ul> <div data-bbox="703 969 1197 1335" data-label="Image"> </div> <ul data-bbox="655 1361 1409 1890" style="list-style-type: none"> <li>○ It is necessary to use the <b>[0]</b>, <b>[1]</b>, <b>[2]</b>, <b>[3]</b>, <b>[4]</b>, <b>[5]</b>, <b>[6]</b>, <b>[7]</b>, <b>[8]</b> and <b>[9]</b> buttons. It is necessary to use the the <b>[A]</b>, <b>[B]</b>, <b>[C]</b>, <b>[D]</b>, <b>[E]</b>, and <b>[F]</b> buttons.</li> <li>○ Press the <b>[Clear]</b> button to delete all the characters in the Input data box.</li> <li>○ Press the <b>[Delete]</b> button to delete the last character in the Input data box.</li> <li>○ Press the <b>[Enter]</b> button to turn the screen to the input item screen if you completed entering the characters in the Input data box.</li> <li>○ Press the <b>[x]</b> button to return to the Input item screen.</li> <li>○ It is not necessary to use the <b>[Shift]</b> button and <b>[Space]</b> button.</li> </ul>

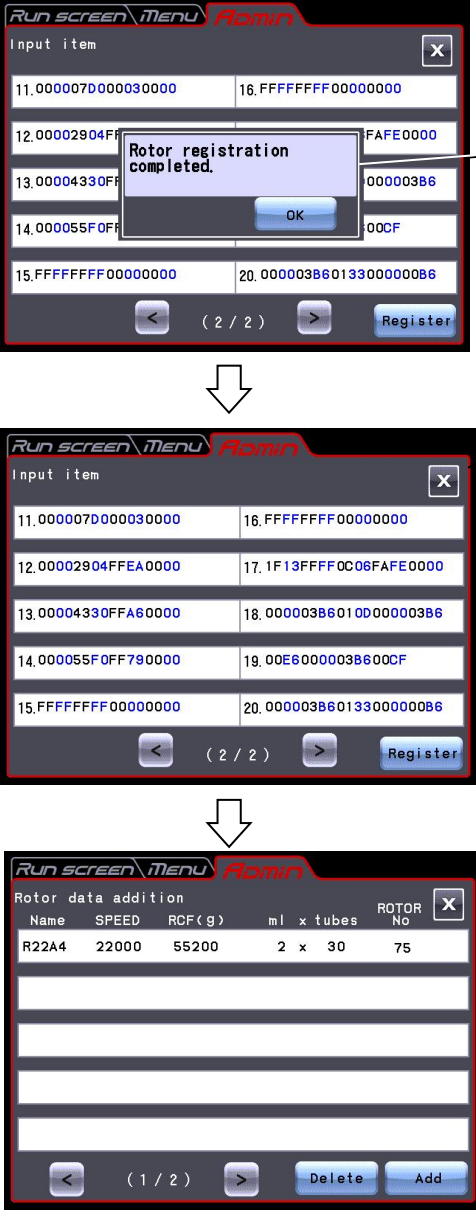
Step	Touch panel operation	Screen displays and notes
4	<p>Complete inputting the rotor registration data in all fields (No.1-No.20) and then press the <b>[Register]</b> button.</p> <p>(If the rotor registration data is not correct, you can not register the rotor.)</p>	<div style="display: flex; flex-direction: column; align-items: center;">  <p style="margin-left: 700px;">[Register] button</p> <div style="margin: 10px 0;">↓</div>  <ul style="list-style-type: none"> <li>• The rotor registration completion box appears.</li> </ul> </div>

Step	Touch panel operation	Screen displays and notes
5	<p>Press the <b>[OK]</b> button on the rotor registration completion box and then press <b>[x]</b> button in the Input item screen to return the Rotor data addition screen.</p>	 <p>The first screenshot shows a dialog box titled "Rotor registration completed." with an "OK" button. The background screen is the "Input item" screen with a list of 20 items and a "Register" button at the bottom right.</p> <p>The second screenshot shows the "Input item" screen with an "X" button in the top right corner. The list of 20 items is visible, and the "Register" button is at the bottom right.</p> <p>The third screenshot shows the "Rotor data addition" screen with a table of rotor data. The table has columns for Name, SPEED, RCF(g), ml x tubes, and ROTOR No. The first row contains the data: R22A4, 22000, 55200, 2 x 30, 75. There are "Delete" and "Add" buttons at the bottom right.</p> <p>Annotations:         <ul style="list-style-type: none"> <li>[OK] button</li> <li>[x] button</li> <li>The added rotor is displayed.</li> </ul> </p>

2) Deleting an added rotor

Step	Touch panel operation	Screen displays and notes
1	In the ADMIN screen, press the <b>[Rotor data addition]</b> icon and then press the row you want to delete the rotor.	<div style="display: flex; align-items: flex-start;"> <div style="flex: 1;">  </div> <div style="flex: 0.5; padding-left: 10px;"> <ul style="list-style-type: none"> <li>• The Rotor data addition screen appears.</li> </ul> <p>Press the row.</p> </div> </div> <div style="text-align: center; margin: 10px 0;">  </div> <div style="display: flex; align-items: flex-start;"> <div style="flex: 1;">  </div> </div>





## 2-7 Emergency Recovery from Power Failure

**⚠ DANGER:** To avoid electrical shock hazards, follow below when servicing the centrifuge.

- 1) Be sure to turn off the POWER switch and turn off the distribution board of your centrifuge room if your centrifuge is equipped with a three wire power cord. Then wait at least three minutes and then remove covers or tables from the centrifuge.
- 2) Be sure to turn off the POWER switch and unplug the power cord from the receptacle if your centrifuge is equipped with a power cord with a plug. Then wait at least three minutes and then remove covers or tables from the centrifuge.

**⚠ WARNING:** 1. Never attempt to open the door while the rotor is rotating.  
2. Never attempt to slow or stop the rotor by hand.

**⚠ CAUTION:** Do not perform any operation not specified in this manual. If any problem is found on your centrifuge, contact an authorized sales or service representative.

(1) Rotation of rotor

The rotating rotor coasts free and finally stops if a power failure occurs during operation. When the power is restored, the centrifuge automatically re-accelerates the rotor if the rotor is still rotating at 250 rpm or higher, or decelerates the rotor if the rotor is rotating below 250 rpm.

(2) Operation panel

During the power failure, all the displays on the control panel are off. When the power is restored, the centrifuge will restart the control of the run with the set parameters that were in effect before the power failure (battery-backed), and will report the occurrence of the power failure by lighting up the alarm message.

(3) Taking out the rotor during power failure

If the power failure is continuing for a long time, and you have decided to remove the rotor from the rotor chamber during the power failure, then take the following procedure.

**⚠ WARNING:** Make sure that the rotor has coasted to a complete stop. When the rotor is at rest, it make no sound. So listen carefully for any sound coming from the rotor chamber. Never attempt to override the door interlock system while the rotor is rotating.

It takes more than 90 minutes for the rotor to come to a complete stop when the rotor is rotating at high speed. Before opening the door, wait until the rotor comes to a stop.

1. Check that the rotor stops completely.
2. If your centrifuge is equipped with a three wire cord, turn off the POWER switch of the centrifuge and turn off the distribution board of your centrifuge room.  
If your centrifuge is equipped with a power cord with a plug, turn off the POWER switch of the centrifuge and unplug the power cord from the receptacle.
3. Remove the two screws from the lower portion of the front cover with the cross-headed screwdriver. Remove the four bolts from the front cover with the hexagonal key (accessory). Remove the front cover by pulling the front cover.
4. Insert the hexagonal bar (accessory) into the hole for releasing the door lock (see below) and turn the hexagonal bar 180 degrees to align the match-marks.

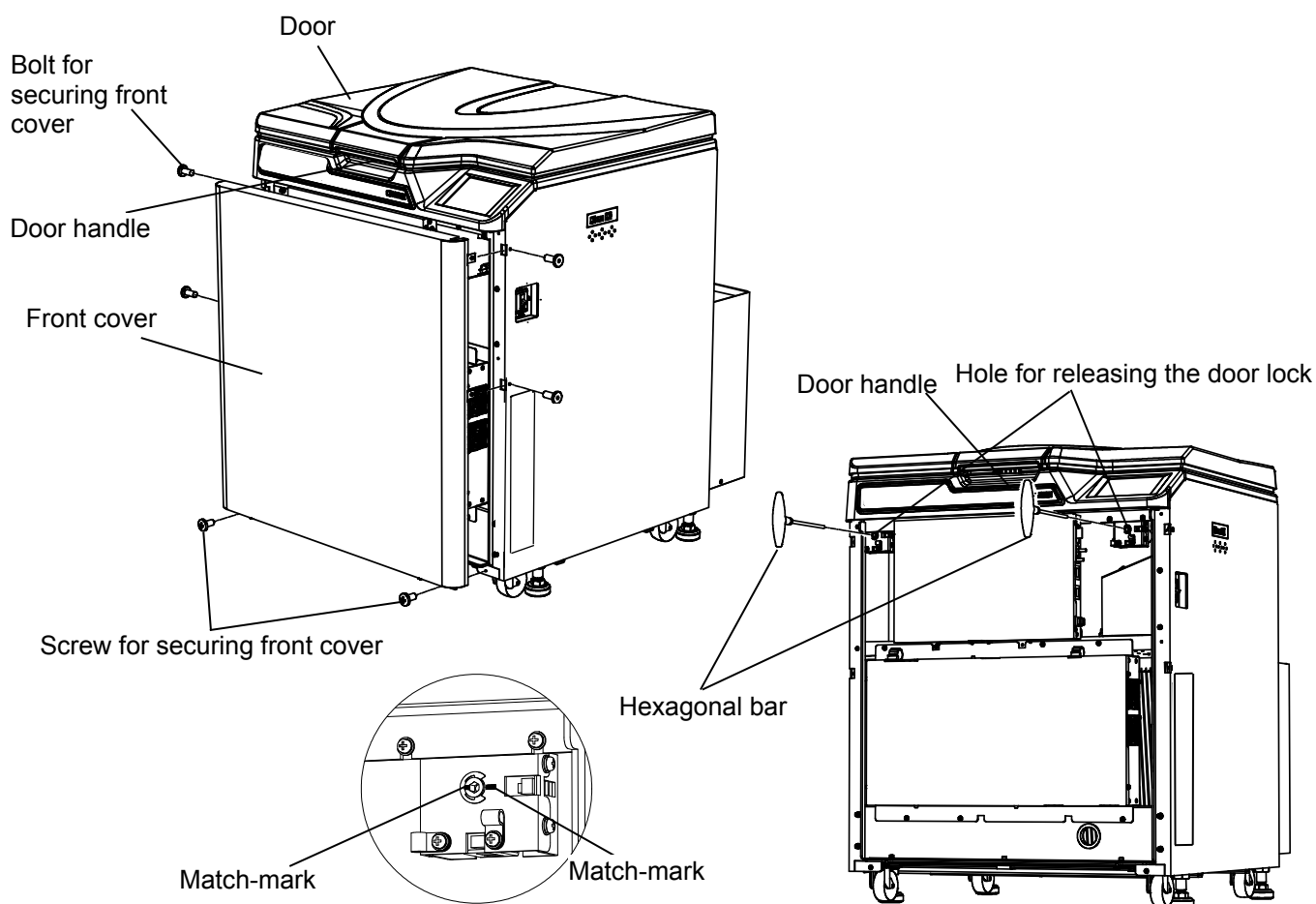

Fig. 3-4 Opening the Door

5. Release the door handle and open the door slowly.  
Check that the rotor stops completely. If the rotor is rotating, close the door immediately.

**⚠ WARNING:** In the event where the door is opened while the rotor is still rotating, close the door immediately.

**⚠ WARNING:** Never attempt to slow or stop the rotor by hand.

6. Take out the rotor. Reinstall the front cover (reverse the removal procedure). Then secure the front cover with the screws.

---

## 3. Maintenance

---

Be sure to read and keep in mind the following cautionary information before maintenance.

-  **DANGER** : To avoid electrical shock hazards, follow below when servicing the centrifuge.
- 1) Be sure to turn off the POWER switch and turn off the distribution board of your centrifuge room if your centrifuge is equipped with a three wire power cord. Then wait at least three minutes and then remove covers or tables from the centrifuge.
  - 2) Be sure to turn off the POWER switch and unplug the power cord from the receptacle if your centrifuge is equipped with a power cord with a plug. Then wait at least three minutes and then remove covers or tables from the centrifuge.

-  **WARNING** : 1.If the centrifuge, rotor, or an accessory is contaminated by samples that are toxic or radioactive, or blood samples that are pathogenic or infectious, be sure to decontaminate the item according to good laboratory procedures and methods.
- 2.If there is a possibility that the centrifuge, rotor, or an accessory is contaminated by samples that might impair human health (for example, samples that are toxic or radioactive, or blood samples that are pathogenic or infectious), it is your responsibility to sterilize or decontaminate the centrifuge, rotor, or the accessory properly before requesting repairs from an authorized sales or service representative. Note that we cannot repair the centrifuge, rotor, or the accessory unless sterilization or decontamination is completed.
- 3.It is your responsibility to sterilize and/or decontaminate the centrifuge, rotor, or parts properly before returning them to an authorized sales or service representative. In such cases, copy the decontamination sheet at the end of this manual and fill out the copied sheet, then attach it to the item to be returned.
- We may ask you about the treatment for the centrifuge, rotor or the part if the decontamination is checked and judged as insufficient by us. It is your responsibility to bear the cost of sterilization or decontamination.
- Note that we cannot repair or inspect the centrifuge, the rotor or the accessory unless sterilization or decontamination is completed.

-  **CAUTION** : Do not perform any operation not specified in this manual. If any problem is found on your centrifuge, contact an authorized sales or service representative.

This centrifuge does not require complicated maintenance and inspection. To ensure safe and trouble-free use for a long time, follow the instructions below.

**⚠ CAUTION** : Using a cleaning or sterilization method other than the ones recommended in this instruction manual might cause corrosion or deterioration of the centrifuge. Refer to the chemical resistance chart provided with the rotor, or contact an authorized sales or service representative.

**⚠ CAUTION** : For sterilization of the surface of the centrifuge and the rotor chamber, wipe them with a cloth dampened with 70% ethanol. Using the method other than the above method might cause corrosion or deterioration of the centrifuge. Refer to the chemical resistance chart provided with the rotor, or contact an authorized sales or service representative. While we recommend that 70% ethanol is used for sterilization, no guarantee of sterility or disinfection is expressed or implied. When sterilization or disinfection is a concern, consult your laboratory safety officer regarding proper methods to use.

**⚠ CAUTION** : Before cleaning or sterilizing the centrifuge, follow below.

- 1) Be sure to turn off the POWER switch and turn off the distribution board of your centrifuge room if your centrifuge is equipped with a three wire power cord.
- 2) Be sure to turn off the POWER switch and unplug the power cord from the receptacle if your centrifuge is equipped with a power cord with a plug.

For information on the maintenance of rotors and tubes, see the rotor instruction manual provided with the rotor.

## 3-1 Rotor Chamber

**⚠ CAUTION:** Do not pour any liquid (such as water, detergent, or disinfectant) directly into the rotor chamber. If you do so, the bearings of the drive unit might corrode or deteriorate.

- (1) If the rotor chamber is found not dry, wipe moisture from the chamber with a cloth or sponge to cool the rotor efficiently. Drain condensed water from the chamber by using the drain hose.
- (2) If the rotor chamber is found dirty, wipe the chamber with a cloth or sponge dampened with a diluted solution of neutral detergent.
- (3) Turn off the centrifuge power and keep the door opened to dry the chamber after operation.

## 3-2 Drive Shaft (Crown)

**⚠ CAUTION:** Once a month, clean the inside of the drive hole (crown hole) of the rotor and the surface of the drive shaft (crown) of the centrifuge. If the drive hole or the drive shaft is stained or any foreign matter adheres to it, the rotor may be improperly installed and come off during operation.

This part is very important because the rotor is mounted on it and the crown transmits the driving force to the rotor. Before mounting a rotor, wipe the outer surface of the crown with a soft cloth sufficiently dampened with water.

## 3-3 Cabinet

Always keep the table and the cabinet of the centrifuge clean to prevent dust and other materials from falling into the rotor chamber. Wipe the table and the cabinet with a cloth or sponge dampened with a diluted solution of neutral detergent. If any solution that is toxic, radioactive, or pathogenic is spilled inside or outside the centrifuge, take necessary action according to your proper laboratory procedures and methods.

## 3-4 Rotor

- (1) To prevent corrosion, take out the rotor from the rotor chamber after operation and remove the rotor cover to dry the tube holes.
- (2) If any sample is spilt inside the rotor, wash and dry the rotor well, then apply silicone grease (vacuum grease) lightly to the rotor.
- (3) Regularly apply lubricant for screw to the thread portion of the rotor cover knob.

## 3-5 Replacement Parts

The table below lists the consumable parts of this centrifuge. It is recommended to replace parts earlier referring to the suggested guidelines for replacement timing in the table below. The timing of replacement varies depending on operation environment and condition.

No.	Description (Part No.)	Guideline for replacement timing
1	Gas spring (2pcs.) (S310137A)	It is recommended to replace the gas spring every three years (about 15,000 times of opening and closing). If the opened door closes naturally or the door feels heavy to open within three years, replace the gas spring with new one.

## 3-6 Others

- (1) Storage period of service parts  
Service parts are kept in stock for seven years after the discontinuation of production.  
The term "service parts" means the parts that are necessary to ensure the correct functioning of the centrifuge.

---

## 4. Troubleshooting

---

Be sure to read and keep in mind the following cautionary information before troubleshooting.

-  **DANGER** : To avoid electrical shock hazards, follow below when servicing the centrifuge.
- 1) Be sure to turn off the POWER switch and turn off the distribution board of your centrifuge room if your centrifuge is equipped with a three wire power cord. Then wait at least three minutes and then remove covers or tables from the centrifuge.
  - 2) Be sure to turn off the POWER switch and unplug the power cord from the receptacle if your centrifuge is equipped with a power cord with a plug. Then wait at least three minutes and then remove covers or tables from the centrifuge.

-  **WARNING** : 1.If the centrifuge, rotor, or an accessory is contaminated by samples that are toxic or radioactive, or blood samples that are pathogenic or infectious, be sure to decontaminate the item according to good laboratory procedures and methods.
- 2.If there is a possibility that the centrifuge, rotor, or an accessory is contaminated by samples that might impair human health (for example, samples that are toxic or radioactive, or blood samples that are pathogenic or infectious), it is your responsibility to sterilize or decontaminate the centrifuge, rotor, or the accessory properly before requesting repairs from an authorized sales or service representative. Note that we cannot repair the centrifuge, rotor, or the accessory unless sterilization or decontamination is completed.
- 3.It is your responsibility to sterilize and/or decontaminate the centrifuge, rotor, or parts properly before returning them to an authorized sales or service representative. In such cases, copy the decontamination sheet at the end of this manual and fill out the copied sheet, then attach it to the item to be returned.
- We may ask you about the treatment for the centrifuge, rotor or the part if the decontamination is checked and judged as insufficient by us. It is your responsibility to bear the cost of sterilization or decontamination.
- Note that we cannot repair or inspect the centrifuge, the rotor or the accessory unless sterilization or decontamination is completed.

-  **CAUTION** : Do not perform any operation not specified in this manual. If any problem is found on your centrifuge, contact an authorized sales or service representative.

This refrigerated centrifuge has a self-diagnosis capability that identifies and reports a problem that occurs when the instrument is starting up or in operation, and that affects the operation of the instrument.

## 4-1 Alarm Messages

When a problem occurs that affects instrument operation, the centrifuge beeps and displays corresponding alarm message, in order to report the occurrence of the problem.



Fig.4-1 Displaying an alarm message

(1) Corrective actions

In response to the displayed alarm message, take the appropriate actions as described below to remove the cause of the problem and then press the [CE] button to restart the centrifugation.

**⚠ WARNING :** Unspecified repairs, remodeling or disassembly of the centrifuge that is not listed below is strictly prohibited by any person other than an authorized services representative.

After taking the actions, if the problem still persists, contact an authorized sales or service representative to ask for repair.

Alarm message	Cause	Corrective action
POWER FAILURE	A power failure occurred while the rotor was spinning and the speed decreased by 300 rpm from the set speed. If the rotor is rotating at 250 rpm or more when the power is restored, the centrifuge will accelerate again or decelerate if the speed is less than 250 rpm.	Check the run time if the rotor has stopped and restart operation if necessary.
SET ROTOR COVER OR ROTOR	Operation is started without mounting the rotor cover.	Mount the rotor cover properly.
	[START] button is pressed when no rotor is installed.	Install the rotor.
	The sensor on the back of the door becomes wet.	Wipe the sensor with a soft cloth.
INVALID ROTOR	The rotor in use is not registered in the centrifuge.	Register the data of the rotor (refer to Section2-6-4 (4) for details).
	The sensor on the back of the door becomes wet.	Wipe the sensor with a soft cloth.
	Use the rotor without the adapter	Use the rotor with the adapter
TEMP	TEMP display shows a temperature over 50 °C, or a temperature lower or higher (plus or minus 20 °C) than the set temperature.	Lower the room temperature if it is over 40 °C.
CLOSE DOOR	[START] button is pressed with the door opened.	Close the door and start operation.
INVALID SPEED	Rotor speed or RCF is set higher than the maximum allowable speed or RCF.	Set the speed or RCF within the permitted limits.
SELECT ROTOR	Incorrect rotor is selected.	Check the rotor and select the correct rotor.
	A rotor other than those saved in the program is used.	
IMBALANCE	Rotor is not properly balanced.	Check if the sample tubes exceed allowable imbalance level.
	Rotor cover is not properly secured.	Secure the rotor cover properly.
ROOM TEMP	The room temperature is over 40 °C.	In order that the room temperature will be less 40 °C, lower the room temperature.
E10~95	The centrifuge has a problem required maintenance by service personnel.	Contact an authorized service representative.



If any of the alarm messages E10 to E95 lights up, it is indicating that the centrifuge has a problem and requires maintenance by an authorized service representative. When you call the service personnel, tell them the displayed alarm code.

**NOTE** The E10 to E13 alarm codes indicate that the speed sensor is malfunctioning. When this alarm codes appear, the centrifuge will not accept an input from the **[CE]** button for 90 minutes, in order to allow the rotor to come to a complete stop. Wait without turning off the power to the centrifuge. Wait at least 90 minutes before pressing the **[CE]** button.  
(This “90 minutes” is the time which passed after a power failure occurs.)

## 4-2 User-corrected Problems

Some problems are not identified and reported by the self-diagnostic capability of the centrifuge. To correct these problems, take the actions described in the table below.

Symptom	Cause	Corrective action
The initial screen is not displayed when the POWER switch is turned on.	The distribution board of your centrifuge room is turned off.	When the distribution board of your centrifuge room is turned off, turn on the distribution board of your centrifuge room and then turn on the POWER switch.  If the distribution board of your centrifuge room is turned on, there is possibility that the earth circuit breaker worked. Contact an authorized service representative.
Centrifuge does not accept entries of run conditions.	<b>[Enter]</b> button is not pressed after entering the numeric values.	Press the <b>[Enter]</b> button after entering run parameters.
Rotor does not start accelerating when <b>[START]</b> button is pressed.	The short beep sounds when the <b>[START]</b> button is pressed.	Check the run conditions again. If the run parameters are not correct, enter the correct run parameters and then close the door securely.
Run conditions cannot be set or recalled.	The rotor is still rotating.	Set or recall the run conditions when the rotor stops completely.
Recalled run conditions are changed.	The battery to back up the programmed memory is dead.	Set the run conditions again and keep the centrifuge turned on for 10 hours to recharge the battery.
Rotor is not cooled.	The room temperature is over 30 °C.	Lower the room temperature using an air conditioner or lower the speed in non-air-conditioned environments.
	A heat-producing device such as a refrigerator or a generator is near the centrifuge.	Relocate the heat-producing device to another place or contact your local dealer to ask for relocation of the centrifuge.
The backlight level of the screen is too dark or too bright.	The brightness of the screen is not adjusted.	Make the adjustment while referring to the clause “Backlight setting” in Section 2-6-3 “Customizing the settings”

---

## 5. Installation and Relocation

---

Installation or relocation of your centrifuge must be done by the authorized service representative. Contact your local dealer or an authorized service representative.

Observe the following instructions for installation or relocation of your centrifuge.

**⚠ DANGER:** To avoid electrical shock hazards, follow below when servicing the centrifuge.

- 1) Be sure to turn off the POWER switch and turn off the distribution board of your centrifuge room if your centrifuge is equipped with a three wire power cord. Then wait at least three minutes and then remove covers or tables from the centrifuge.
- 2) Be sure to turn off the POWER switch and unplug the power cord from the receptacle if your centrifuge is equipped with a power cord with a plug. Then wait at least three minutes and then remove covers or tables from the centrifuge.

### (1) Electric power requirements

Your centrifuge can operate on the following power source: Single phase, AC 200, 208, 220, 230 or 240 V $\pm$ 10%; 50/60 Hz; 30A. Provide an emergency switch (circuit breaker) intended for the centrifuge only to turn off the centrifuge power in the event of failure. It is recommended to provide that switch at the outside of the centrifuge room or near the exit of the centrifuge room.

When your centrifuge is equipped with a power cord with a NEMA 6-30P plug to fit a NEMA 6-30R receptacle, do not position an object so that it is difficult to disconnect the power cord from the receptacle. If you do so, you cannot disconnect the power cord from the receptacle when you observe some abnormality.

### (2) Location

**⚠ WARNING:** For operator safety, maintain a 30-cm "clearance envelope" around the instrument and keep out that area while the rotor is spinning. Do not store dangerous substances capable of developing flammable or explosive vapors on nor near the centrifuge.

- a) Install the centrifuge on a flat, vibration-free concrete or stone floor. Avoid installing on a carpeted floor or other unsolid floor.
- b) Ambient temperature range is 2 °C to 40 °C.  
The rotor temperature will be high if the ambient temperature becomes higher than 25 °C.  
Avoid a place exposed to direct sunlight.
- c) Maintain a 30-cm "clearance envelope" around the centrifuge. Do not store any substances in the clearance envelope.
- d) In order to cool the rotor chamber properly, do not put any objects in the rear duct Ass'y.

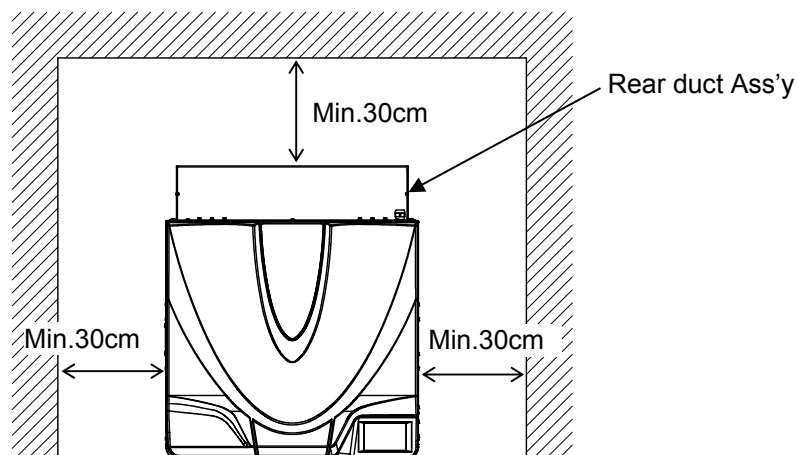

Fig.5-1 Location requirement

## (3) Power cord

**⚠ WARNING:** Your centrifuge must be grounded properly to avoid electrical shock hazards.

**⚠ WARNING:** Do not touch the power cord with wet hands to avoid electrical shocks.

- 1) When your centrifuge is equipped with a three wire power cord (see below), plug the power cord coming from the rear of the centrifuge in the terminal of the distribution board in accordance with ANSI/NFPA 70, NEC, with CSA C22.1, CEC, Part I or with both as appropriate. The green/yellow wire is a grounding wire. Your centrifuge must be grounded properly.

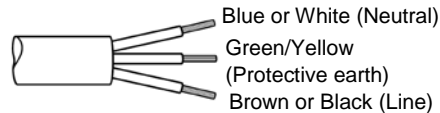

- 2) When your centrifuge is equipped with a power cord with a NEMA 6-30P plug (see below) to fit a NEMA 6-30R receptacle, plug the power cord coming from the rear of the centrifuge into the receptacle. Your centrifuge must be grounded properly.

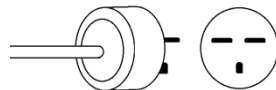

**⚠ WARNING:** Do not hold the cord when disconnecting the power cord from the receptacle. Hold the plug when disconnecting it.

## (4) Leveling

- Turn on the centrifuge power and open the door. (If power supply is not yet available, refer to section 2-7.)
- Place the level across the top of the drive shaft.

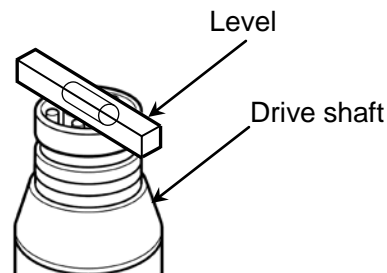
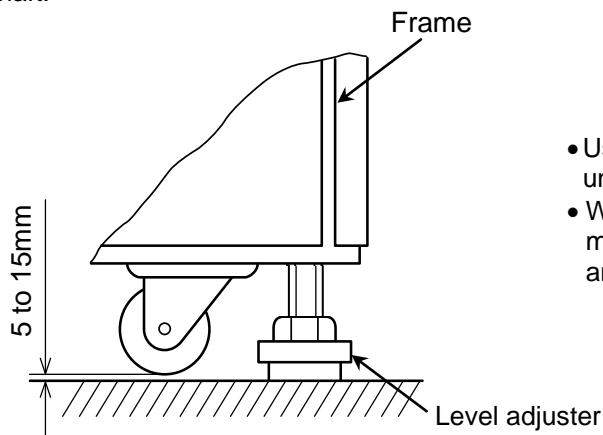

- Using a wrench, turn each of the four level adjusters until the casters are 5 to 15 mm off the floor.
- When the centrifuge is level, remove the level and make sure each of the four level adjusters is secure and rattle-free.

**⚠ WARNING :** Elevate this centrifuge by turning the four level adjusters and level it .  
Do not use this centrifuge with its casters on.

**⚠ CAUTION :** Do not use this centrifuge while one of the four level adjusters is unstable.  
It may cause vibration that results in damage to the centrifuge.

## (5) Relocation

Before relocating the centrifuge, unplug the centrifuge and lower the casters on the floor by turning the leveling bolts with a wrench. Raise the leveling bolts enough and relocate the centrifuge. After relocation, the centrifuge must be installed and leveled again.

**⚠ CAUTION :** Remove the rotor from the rotor chamber before relocating the centrifuge.  
Be careful when carrying on uneven or slanted floors not to turn over the centrifuge

(6) Handling the drain hose

- ⚠ CAUTION:**
- Be careful not to hurt your hands or fingers when cutting the band fixing the drain hose.
  - Cooling ability degrades if this centrifuge is operated with its drain hose inserted in an effluent container without the cap on.

1. Insert the clamps (accessories) into the holes of the lower left side of the centrifuge.
2. The drain hose is fastened to the back of the centrifuge by a band during transport. Cut this band to facilitate drainage. Fix the hose to the centrifuge with the clamps (see the right figure).
3. Remove the cap at the tip of the drain hose only while draining the centrifuge. Keep the cap on. Be careful not to lose it.

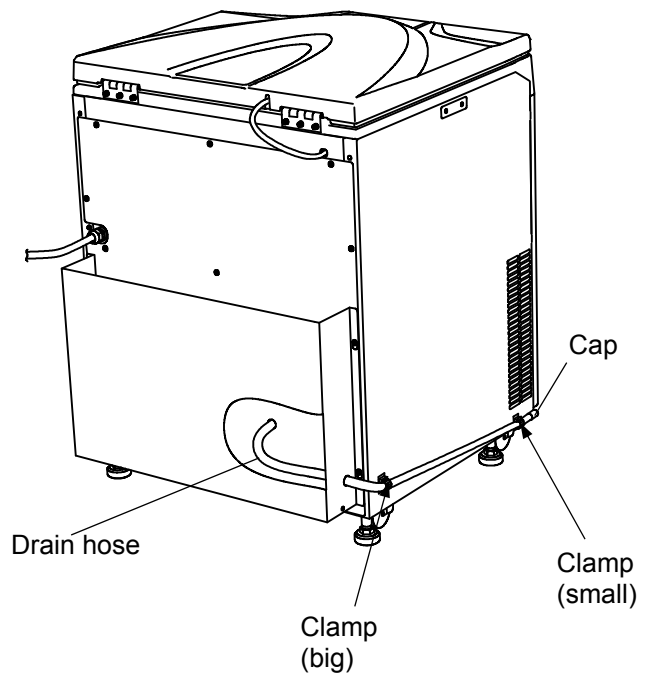

Installation or relocation of your centrifuge must be done by the authorized service representative.  
Contact an authorized sales or service representative.

---

*MEMO*

---

## 6. Specifications

	CR22N	CR21N
Maximum speed	22,000 rpm	21,000 rpm
Maximum RCF	55,200xg (R22A4 rotor)	53,200xg (R21A rotor)
Maximum nominal capacity	6,000ml (R9A2 rotor)	4,000ml (R9A rotor)
Set speed	300 to 22,000rpm	300 to 21,000rpm
Set temperature	-20° C to +40° C	
Set time	1 second to 99 minutes and 59 seconds; HOLD for continuous operation (Option: 1 minute to 99 hours and 59 minutes)	
Acceleration/deceleration control	9-stage variable acceleration control, 9-stage braked deceleration, plus coasting deceleration control	
Program function	Capable of saving 30 programmed run conditions, displaying/setting the RCF(g) and g·sec, and RTC (real-time control) operation	
Lockout function	available	
Machine log management function	available	
Variable deceleration slope function	available	unavailable
Driving motor	Induction motor (inverter-controlled)	
Refrigerator	Hermetically sealed (refrigerant: HFC410A) (For further information, see the instrument labels*1.)	
Safety devices	Door interlock, dual-overspeed detector, imbalance detector and over-temperature detector	
Applicable standard	CE marking (*)	
Noise level	$\leq 64$ dB(A) at 22,000 rpm setting 4°C (measured 1m in front of the instrument)	
Dimensions	700 (W) x 760* (D) x 915 (H) mm from bottom to the chamber inlet: 853mm *Measurement including the rear duct Ass'y	
Screen display and operation	Color touch-sensitive LCD*2	
Power requirements	<ul style="list-style-type: none"> <li>•Supply required Single phase: AC200/208/220/230/240 V+/-10 %, 50/60 Hz, 30 A</li> <li>•Centrifuge rating AC200-240 V, 50/60 Hz, 24 A</li> </ul>	
Environment requirements	Altitude 2000M max. Humidity of 80% max. for temperatures up to 31°C, decreasing to 50% relative humidity at 40 °C Indoor use Installation category: II Pollution degree:2	
Ambient temperature	Ambient temperature for operation : 2°C to 40°C Ambient temperature for performance guarantee : 15°C to 25°C	
Weight	260 kg	



The CR22N/CR21N centrifuges satisfy CE marking requirements. The CE marking is an international symbol, which shows that the product conforms to EU directives. Standards concerning these directives are as follows:

- Machinery Directive (2006/42/EC)
- Low Voltage Directive (2014/35/EU)  
EN 61010-1:2010, EN 61010-2-020:2006
- EMC Directive (2014/30/EU)  
EN 61326-1: 2013 Class A
- RoHS Directive (2011/65/EU)  
EN 50581: 2012











(\*) The following are required to satisfy the CE Marking requirements for the use of the CR22N/CR21N centrifuges.

- (1) Only the rotors with overspeed adapters (magnets) must be used.  
The CR22N refrigerated centrifuge does not conform to the CE marking requirements when using a continuous flow rotor due to the construction of the rotor.  
A continuous flow rotor is not applicable to the CR21N refrigerated centrifuge.

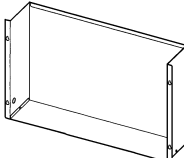
\*1: Because the instrument labels may differ from one country to another, please contact your local dealer or an authorized sales or service representative.

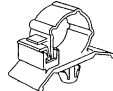
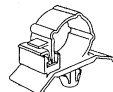
\*2: Please note that the LCD panel may contain a few dead or stuck pixels.

## 7. List of Standard Accessories

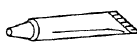
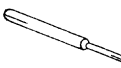
No.	Accessory	Q'ty	Figure	Remarks
1	Instruction manual	1		S998403
2	List* of applicable rotors	1		S998322
		1		S998492
3	Summarized sheet of instruction manual	1		S998317
4	Instruction manual (Not conforming to CE Marking requirements)	1		S998320 (Only for the CR22N centrifuges that do not conform to CE Marking requirements)
5	Rear duct Ass'y	1		S205386A (To be mounted to the rear cover at installation)
6	Level	1		84850901
7	Clamp (big)	1		7903159
8	Clamp (small)	1		7903157
9	Hexagonal bar	1		S413606
10	Hexagonal key	1		60000122
11	Silicone grease (Vacuum grease)	1		S413837
12	Lubricant for screw	1		84810601
13	Rotor cleaning bar	1		S301333

\*The provided list is one of them (see above).



## 8. Tubes and Bottles

### Cleaning and sterilizing tubes and bottles

Use the best method for cleaning and sterilizing tubes and bottles, referring to the table below.

Cleaning and sterilizing conditions for tubes and bottles

✓: Applicable    ✗: Inapplicable

Condition		Material	PA	PC	PP
Cleaning	Cleaning fluids	Acidic (pH5 or lower)	✗	✗	✗
		Acidic (higher than pH5)	✓	✓	✓
		Alkaline (higher than pH9)	✓	✗	✓
		Alkaline (pH9 or lower)	✓	✓	✓
		Neutral (pH7)	✓	✓	✓
		Warm water (up to 70°C)	✓	✓	✓
	Ultrasonic cleaning	Neutral detergent (pH7)	✓	✓	✓
Sterilization	Autoclaving	115°C (0.7kg / cm <sup>2</sup> ) 30 minutes	✓	✓	✓
		121°C (1.0kg / cm <sup>2</sup> ) 20 minutes	✗	✓	✓
		126°C (1.4kg / cm <sup>2</sup> ) 15 minutes	✗	✗	✗
	Boiling	15 to 30 minutes	✓	✓	✓
	Ultraviolet sterilization	200 to 300 nm	✗	✗	✗
	Gas sterilization	Ethylene oxide	✓	✗	✓
	Formaldehyde	✓	✓	✓	

PA: Polypropylene copolymer    PC: Polycarbonate    PP: Polypropylene

### Cleaning PC tubes and bottles

PC materials have low chemical resistance to alkaline solutions. Avoid using neutral detergents higher than pH9. Note that some neutral detergents are still higher than pH9 even if diluted according to the instruction in the maker's catalog. Use detergents between pH7 and pH9.

### Autoclaving PA, PC and PP tubes and bottles

PA begins softening at about 120°C, and PC and PP at about 130°C. Autoclave PA tubes/bottles at 115°C (0.7 kg/cm<sup>2</sup>) for 30 minutes and PC and PP tubes/bottles at 121°C (1.0 kg/cm<sup>2</sup>) for 20 minutes. If a certain temperature is exceeded, the tubes/bottles may be deformed.

Observe the following instructions when using a sterilizing chamber:

- (1) Place bottles in a vertical position, mouths facing up. If bottles are placed sideways, they may deform into an oval shape due to their own weight.
- (2) Remove screw caps and inner covers to prevent deformation or rupture.
- (3) Wait until the sterilizing chamber cools down to room temperature before removing the bottles.

Conditions and life expectancy of tubes and bottles

**⚠ CAUTION:** Do not use tubes/bottles that have exceeded their life expectancy. Failure to do so could result in damage of tubes/bottles and the rotor and the centrifuge. The life expectancy of tubes/bottles depends on factors such as the characteristics of samples, speed of the rotor used, and temperature. Always check for deterioration and damage (cracks, deformation, and so on) on tubes/bottles before using them. Do not use the tubes/ bottles if you find such a problem.

The life expectancies of plastic tubes and bottles depend on factors such as the characteristics of samples, speed of the rotor used, and temperature.

When plastic tubes/bottles are used for centrifugation of ordinary aqueous samples (between pH5 and pH9), their life expectancies are specified as follows.

When operated for 1 hour at the maximum speed:

Tubes (PA, PC, PP): 5 operations

Thick-walled tubes and bottles (PA, PC, PP): 50 operations

himac 50 TC tubes, himac 15 TC tubes, and tubes on the market: 1 operation

The life expectancies of the PC bottles are specifically specified as follows according to the pretreatment conditions such as cleaning and sterilization.

Cleaning and sterilization	Gas sterilization and cleaning with warm water	Autoclaving at 121°C for 20 min.
Sample		
Neutral (PH7)	50 operations	10 operations
Alkalescent (PH7 to 9)	30 operations	5 operations

Do not use crazed (cracked) tubes or bottles.

The life expectancy of a plastic tube/bottle as the above is an approximate guide. We do not warrant the life expectancies of tubes/bottles.

# APPENDIX

It is requested that you return the faulty product with this Decontamination Sheet in order to repair it safely in our plant.

Be sure to decontaminate the product according to good laboratory procedures and methods, and fill out this Decontamination Sheet and attach it to the product to be returned to Eppendorf Himac Technologies for repair.

Attention: Eppendorf Himac Technologies Co., Ltd.

## Decontamination Sheet

Date: \_\_\_\_\_

Name: \_\_\_\_\_

Name of company(organization) or school: \_\_\_\_\_

Division or faculty/Subject of study: \_\_\_\_\_

Telephone number: \_\_\_\_\_

Address: \_\_\_\_\_

I performed decontamination to remove biological or chemical contaminants(including radioactive isotope) from this product as follows.

Model of centrifuge: \_\_\_\_\_

Serial number \_\_\_\_\_

Model of rotor: \_\_\_\_\_

Serial number \_\_\_\_\_

Accessory: \_\_\_\_\_

Serial number \_\_\_\_\_

Contaminants used: \_\_\_\_\_

Decontamination methods(conditions): \_\_\_\_\_

\_\_\_\_\_

\_\_\_\_\_

Date of decontamination \_\_\_\_\_

Signature \_\_\_\_\_

\* If you return an ultracentrifuge rotor, fill out the following information.

Number of runs of the rotor \_\_\_\_\_

Cumulative operating time of the rotor \_\_\_\_\_

### **WEEE Compliance**

The mark is in compliance with the Waste Electrical and Electronic Equipment Directive 2012/19/EU (WEEE).

The mark indicates the requirement NOT to dispose the equipment as unsorted municipal waste, but use the return and collection systems available.

For further information regarding return, collection, recycle or disposal, please contact your local dealer or an authorized sales or service representative.



### **Marking for the restriction of the use of hazardous substances in electrical and electronic product**

#### **(THE PEOPLE'S REPUBLIC OF CHINA)**

The mark and separated sheet "Names and Contents of Hazardous Substances in Each Component of This Centrifuge" are in compliance with "People's Republic of China Electronic Industry Standard SJ/T11364-2014" requirements.

The mark indicates that this electrical and electronic product contains certain hazardous substances, and can be used safely during its environment-friendly use period. The number in the middle of the mark indicates the environment-friendly use period of the product. The outer circle indicates that the product can be recovered.



---

*MEMO*

---



## After-Sales Service

Periodic inspection of the centrifuge is recommended to assure safe and efficient operation. If the centrifuge fails to function normally, do not attempt to repair it yourself. Contact an authorized sales or service representative.

---

**Eppendorf Himaс Technologies Co., Ltd.**

1060, Takeda, Hitachinaka City  
Ibaraki Pref., 312-8502 Japan

URL: <https://www.himac-science.com>