

Register your instrument!  
[www.eppendorf.com/myeppendorf](http://www.eppendorf.com/myeppendorf)



# FemtoJet<sup>®</sup> 4x

Operating manual

Copyright© 2017 Eppendorf AG, Germany. All rights reserved, including graphics and images. No part of this publication may be reproduced without the prior permission of the copyright owner.

Eppendorf® and the Eppendorf Brand Design are registered trademarks of Eppendorf AG, Germany.

FemtoJet®, Femtotips®, TransferMan® and InjectMan® are registered trademarks of Eppendorf AG, Germany.

Registered trademarks and protected trademarks are not marked in all cases with ® or ™ in this manual.

## Table of contents

<b>1</b>	<b>Operating instructions</b>	<b>7</b>
1.1	Using this manual	7
1.2	Danger symbols and danger levels	7
1.2.1	Danger symbols	7
1.2.2	Danger levels	7
1.3	Symbols used	7
<b>2</b>	<b>Safety</b>	<b>8</b>
2.1	Intended use	8
2.2	Warnings for intended use	8
2.3	Warning signs on the device	9
2.4	User profile	9
2.5	Information on product liability	9
<b>3</b>	<b>Product description</b>	<b>10</b>
3.1	Delivery package	10
3.2	Features	10
3.3	Exemplary set-up of a microinjection system	11
3.4	Product overview	12
3.4.1	Interfaces	13
3.5	Name plate	14
3.6	Control panel	15
3.7	Rotary knobs	16
3.8	Foot control	17
3.9	Hand control	17
3.10	Pressure tube	18
3.11	Injection tube	19
3.12	Pressure parameters	19
3.12.1	Compensation pressure $p_c$	20
3.12.2	Injection pressure $p_i$	20
3.12.3	Injection time $t_i$	20
3.12.4	Rinsing pressure	21
3.12.5	Operating pressure $p_w$	21
3.13	Self-calibration	21
3.14	Capillary holder 4	21
3.15	Grip head 4	22
<b>4</b>	<b>Installation</b>	<b>23</b>
4.1	Preparing installation	23
4.1.1	Complaints about damages	23
4.1.2	Incomplete delivery	23
4.2	Selecting the location	23

## Table of contents

4 FemtoJet® 4x  
English (EN)

4.3	Connecting the external pressure supply . . . . .	23
4.3.1	Preparing the external pressure supply . . . . .	24
4.3.2	Connecting the compressor. . . . .	24
4.3.3	Connecting the compressed gas cylinder . . . . .	24
4.3.4	Connecting the in-house compressed air supply . . . . .	25
4.4	Connecting the Microinjector . . . . .	25
4.5	Inserting o-rings in the grip head . . . . .	26
4.6	Connecting an external device . . . . .	26
4.6.1	Connecting a micromanipulator . . . . .	27
4.6.2	Connecting the PC. . . . .	27
4.6.3	Connecting two devices. . . . .	27
4.7	Connecting accessories. . . . .	28
4.7.1	Connecting a foot control . . . . .	28
4.7.2	Connecting a hand control . . . . .	28
<b>5</b>	<b>Software . . . . .</b>	<b>29</b>
5.1	Main screen. . . . .	29
5.2	Main menu . . . . .	30
5.3	Navigating in the menu. . . . .	30
5.3.1	Selecting the menu and navigating. . . . .	30
5.3.2	Exiting the menu . . . . .	30
5.3.3	Selecting parameters. . . . .	31
5.3.4	Changing a parameter value . . . . .	31
<b>6</b>	<b>Operation . . . . .</b>	<b>32</b>
6.1	Switching on or off the Microinjector . . . . .	32
6.1.1	Switching on the Microinjector. . . . .	32
6.1.2	Switching off the Microinjector. . . . .	32
6.2	Switching on or off the standby mode . . . . .	32
6.2.1	Switching on standby mode . . . . .	32
6.2.2	Switching off the standby mode . . . . .	32
6.3	Determining the injection parameters . . . . .	33
6.3.1	Filling the capillaries with fluorescence dye . . . . .	33
6.3.2	Carrying out a test injection . . . . .	33
6.3.3	Possible sources of error - cell inflates or bursts . . . . .	33
6.3.4	Possible sources of error - capillary is clogged. . . . .	33
6.3.5	Possible sources of error - liquid is not being injected. . . . .	34
6.3.6	Possible sources of error - capillary does not reach the cell. . . . .	34
6.3.7	Result – the injection parameters have been determined . . . . .	34
6.4	Setting the compensation pressure $p_c$ . . . . .	34
6.5	Setting the injection pressure $p_i$ . . . . .	34
6.6	Setting the injection time $t_i$ . . . . .	35
6.7	Setting the injection mode . . . . .	35
6.7.1	Setting the automatic injection mode . . . . .	35
6.7.2	Setting the manual injection mode . . . . .	35

6.8	Injecting liquid . . . . .	36
6.8.1	Automatically injecting liquid . . . . .	36
6.8.2	Manually injecting liquid. . . . .	36
6.9	Replacing the capillary . . . . .	36
6.10	Rinsing the capillary . . . . .	37
6.11	Setting the injection counter to zero. . . . .	37
6.12	Calling up saved injection parameters . . . . .	37
6.12.1	Calling up saved injection parameters . . . . .	37
6.13	Saving or changing the injection parameters. . . . .	38
6.13.1	Saving injection parameters . . . . .	38
6.13.2	Changing the saved injection parameters. . . . .	38
6.14	Adjusting the device settings . . . . .	38
6.14.1	Change capillary function – Changing the capillary . . . . .	38
6.14.2	Pressure unit function – Selecting the pressure unit . . . . .	38
6.14.3	Beeper function – Switching on/off the signal tone . . . . .	39
6.14.4	Contrast function – Setting the display contrast . . . . .	39
6.14.5	Illumination function – Switching on/off the display illumination. . . . .	39
6.14.6	Continuous flow function – Setting the constant operating pressure. . . . .	39
6.15	Inserting the capillary into the capillary holder . . . . .	40
6.16	Inserting Femtotips into the capillary holder . . . . .	40
<b>7</b>	<b>Troubleshooting . . . . .</b>	<b>41</b>
7.1	General errors . . . . .	41
7.2	Error messages . . . . .	41
7.2.1	Error 01 – 10 . . . . .	41
7.2.2	Error 11 – 18 . . . . .	42
7.2.3	Error 19 – 38 . . . . .	44
7.2.4	Warnings 37 – 40. . . . .	45
<b>8</b>	<b>Maintenance. . . . .</b>	<b>48</b>
8.1	Exchanging the o-rings in the grip head . . . . .	48
8.1.1	Remove the o-rings and distancing sleeves . . . . .	48
8.1.2	Inserting the o-rings and the distance sleeve . . . . .	49
8.2	Exchanging the o-ring in the Femtotips adapter . . . . .	50
8.2.1	Exchanging the o-ring. . . . .	50
8.3	Replacing fuses . . . . .	51
8.4	Cleaning . . . . .	51
8.5	Disinfection/decontamination . . . . .	52
8.6	Hints with regard to service intervals . . . . .	52
8.7	Service and maintenance . . . . .	52
<b>9</b>	<b>Technical data . . . . .</b>	<b>53</b>
9.1	Mode of operation. . . . .	53
9.2	Weight/dimensions . . . . .	53

## 6 Table of contents

FemtoJet® 4x  
English (EN)

9.3	Power supply . . . . .	53
9.4	Interfaces . . . . .	53
	9.4.1 USB . . . . .	53
	9.4.2 RS 232 . . . . .	53
9.5	External compressed air supply . . . . .	55
9.6	Ambient conditions . . . . .	55
<b>10</b>	<b>Transport, storage and disposal . . . . .</b>	<b>56</b>
10.1	Storage . . . . .	56
10.2	Decontamination before shipment . . . . .	56
10.3	Transport . . . . .	56
10.4	Disposal . . . . .	57
<b>11</b>	<b>Ordering information . . . . .</b>	<b>58</b>
11.1	FemtoJet 4x . . . . .	58
11.2	Accessories for FemtoJet 4x . . . . .	58
11.3	Capillary holders 4 and grip heads 4 . . . . .	59
11.4	Capillaries . . . . .	59
	<b>Index . . . . .</b>	<b>60</b>
	<b>Certificates . . . . .</b>	<b>63</b>

## 1 Operating instructions





### 1.1 Using this manual

- ▶ Read this operating manual completely before using the device for the first time. Also observe the instructions for use of the accessories.
- ▶ This operating manual is part of the product. Thus, it must always be easily accessible.
- ▶ Enclose this operating manual when transferring the device to third parties.
- ▶ You will find the current version of the operating manual for all available languages on our website under [www.eppendorf.com/manuals](http://www.eppendorf.com/manuals).

## 1.2 Danger symbols and danger levels

### 1.2.1 Danger symbols



The safety instructions in this manual have the following danger symbols and danger levels:

	<b>Electric shock</b>		<b>Hazard point</b>
	<b>Cuts</b>		<b>Material damage</b>
	<b>Biohazard</b>		

### 1.2.2 Danger levels

<b>DANGER</b>	<i>Will</i> lead to severe injuries or death.
<b>WARNING</b>	<i>May</i> lead to severe injuries or death.
<b>CAUTION</b>	May lead to light to moderate injuries.
<b>NOTICE</b>	May lead to material damage.

### 1.3 Symbols used

Depiction	Meaning
1.	Actions in the specified order
2.	
▶	Actions without a specified order
•	List
	Direction of movement
<i>Text</i>	Display text or software text
	Additional information

## 2 **Safety**

### 2.1 **Intended use**

The FemtoJet 4x Microinjector is designed and manufactured for the exclusive use within the context of biological, chemical and physical research.

Together with the micromanipulator and the capillary, the Microinjector forms a microinjection system. The Microinjector is used for the precise and reproducible injection of extremely small amounts of fluid (femto liter to micro liter range) in biological cells or nuclei.

The Microinjector is intended exclusively for indoor use and for operation by qualified staff.

### 2.2 **Warnings for intended use**

---



#### **WARNING! Risk of injury due to flying capillaries and glass splinters.**

If exposed to high pressures, capillaries can detach themselves from the grip heads and become projectiles.

Capillaries can crack as a result of incorrect handling.

- ▶ Wear protective goggles.
- ▶ Never aim capillaries at people.
- ▶ Use capillaries with an outer diameter that matches the grip head specifications.
- ▶ Always mount / dismount capillaries when they are depressurized.
- ▶ Mount the capillary correctly in the grip head.
- ▶ Do not touch the capillary with the Petri dish or other objects.



#### **CAUTION! Risk of cuts from broken capillaries.**

Capillaries are made of glass. They are very sharp and fragile.

- ▶ Wear your personal protective equipment (PPE).
- ▶ Always mount capillaries depressurized.
- ▶ Never aim capillaries at people.
- ▶ Handle the capillaries very carefully.





**WARNING! Damage to health due to infectious liquids and pathogenic germs.**

- ▶ When handling infectious liquids and pathogenic germs, observe the national regulations, the biological safety level of your laboratory, the material safety data sheets, and the manufacturer's application notes.
- ▶ Wear your personal protective equipment.
- ▶ Consult the "Laboratory Biosafety Manual" (source: World Health Organization, Laboratory Biosafety Manual, in its respectively current valid version).

**2.3 Warning signs on the device**

Warning symbol	Meaning
	Read the operating manual

**2.4 User profile**

The device and accessories may only be operated by trained and skilled personnel.

Before using the device, read the operating manual carefully and familiarize yourself with the device's mode of operation.

**2.5 Information on product liability**

In the following cases, the designated protection of the device may be compromised. Liability for any resulting property damage or personal injury is then transferred to the operator:

- The device is not used in accordance with the operating manual.
- The device is used outside of its intended use.
- The device is used with accessories or consumables which are not recommended by Eppendorf.
- The device is maintained or repaired by people not authorized by Eppendorf.
- The user makes unauthorized changes to the device.

**Product description**

FemtoJet® 4x

English (EN)

**3 Product description****3.1 Delivery package**

Quantity	Description
1	FemtoJet 4x
1	Injection tube
1	Capillary holder 4
1	Pressure tube with quick coupling and plug
1	Quick coupling (nickel plated), cylindrical thread
1	Quick coupling (brass), conical thread
1	Grip head 4 for capillaries with an outer diameter of 1.0 to 1.1 mm
1	Adapter for Femtotips
1	Foot control
1	Mains/power cord
1	Bag (for rotary knobs)
1	Operating manual

**3.2 Features**

The Microinjector FemtoJet 4x can be used to inject amounts of fluid of up to 1  $\mu\text{L}$  into cells. The parameters for pressure and time are set on the device and controlled by the software. It is possible to trigger the injection on the Microinjector or on a connected micromanipulator by Eppendorf. The semiautomatic injection movement is controlled by the Microinjector or the micromanipulator. The required pressure is provided by an external pressure source (e.g. in-house compressed air supply or compressed gas cylinder).

### 3.3 Exemplary set-up of a microinjection system

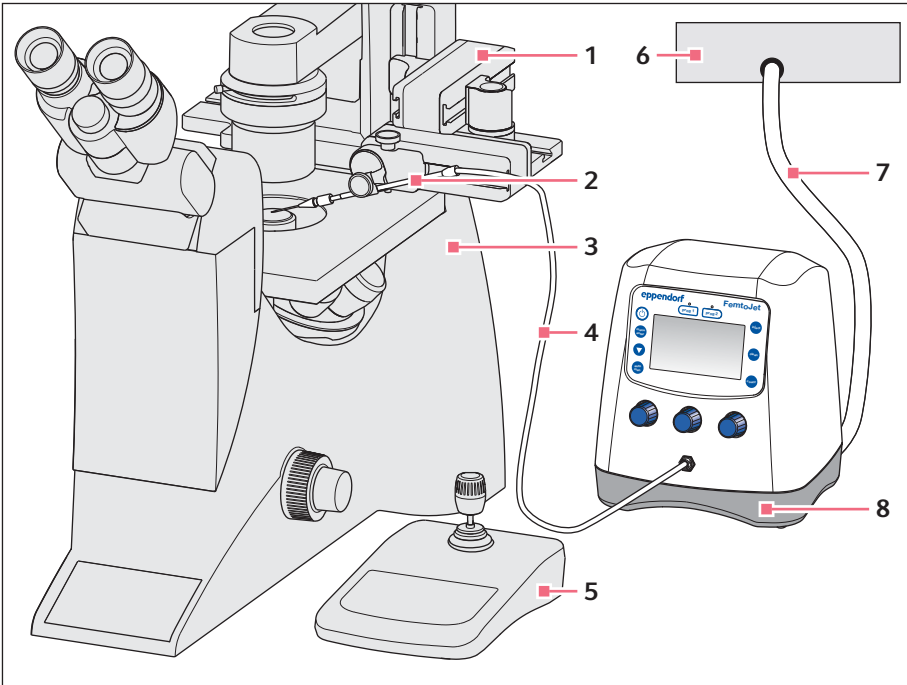

Fig. 3-1: Microinjection system with FemtoJet 4x

- |   |  |   |  |
|---|--|---|--|
| 1 | <b>Micromanipulator InjectMan 4</b>              | 5 | <b>Control board InjectMan 4</b>   |
| 2 | <b>Universal capillary holder with capillary</b> | 6 | <b>External pressure supply</b><br>Compressor, compressed gas cylinder or in-house compressed air supply |
| 3 | <b>Inverse microscope</b>                        | 7 | <b>Pressure tubing</b>   |
| 4 | <b>Injection tube</b>                            | 8 | <b>Microinjector FemtoJet 4x</b>   |

### 3.4 Product overview

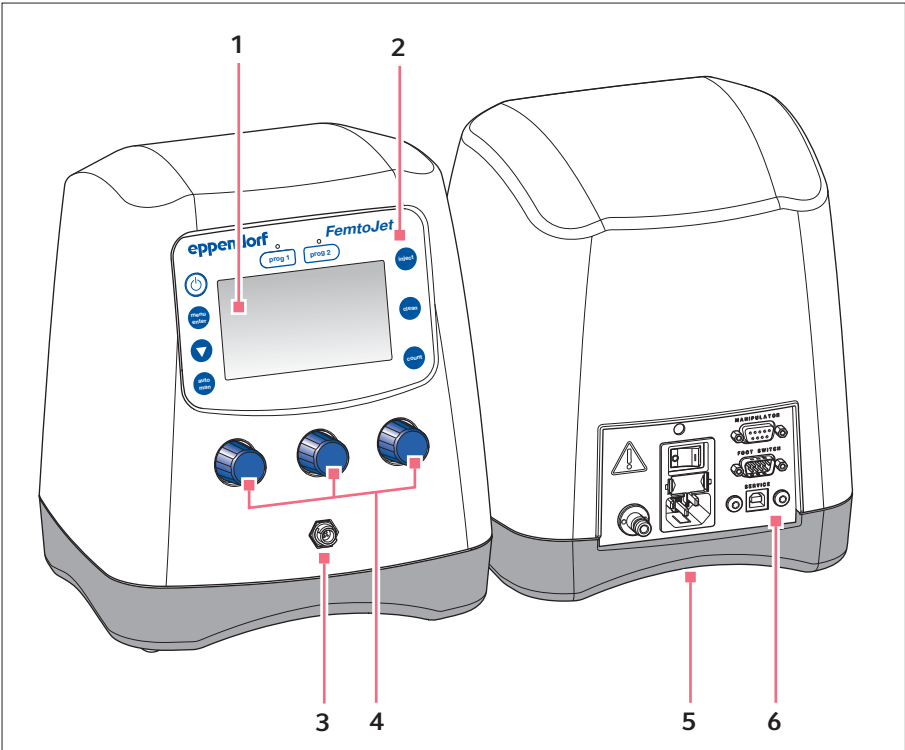

Fig. 3-2: Front and rear side

- |                                    |   |
|------------------------------------|---|
| 1 Display                          | 4 Rotary knobs for injection parameters |
| 2 Control panel                    | 5 Name plate<br>Lower side of device    |
| 3 Bayonet joint for injection tube | 6 Interfaces                            |

### 3.4.1 Interfaces

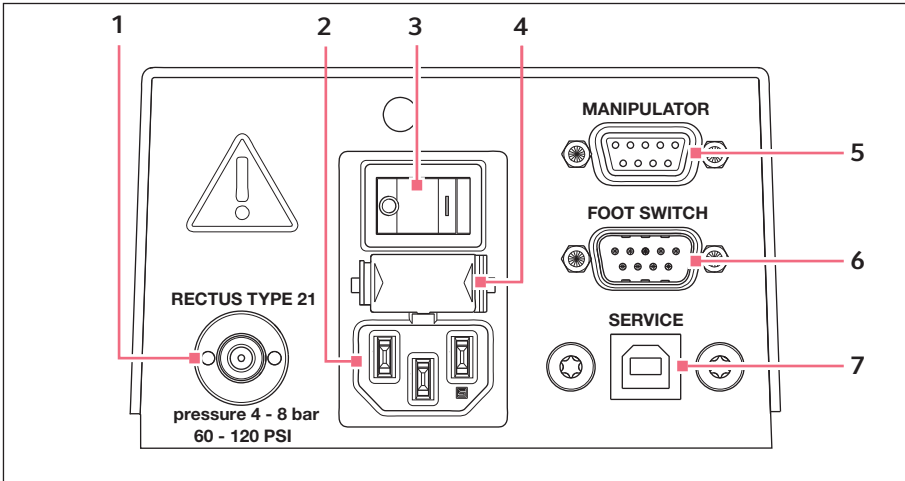

Fig. 3-3: Interfaces

- |  |  |
|--|--|
| <b>1</b> Port for external pressure supply | <b>5</b> Port for micromanipulator or computer |
| <b>2</b> Mains/power connection            | <b>6</b> Connection for foot or hand control   |
| <b>3</b> Mains/power switch On/Off         | <b>7</b> Service connection                    |
| <b>4</b> Micro fuse                        |  |

### 3.5 Name plate

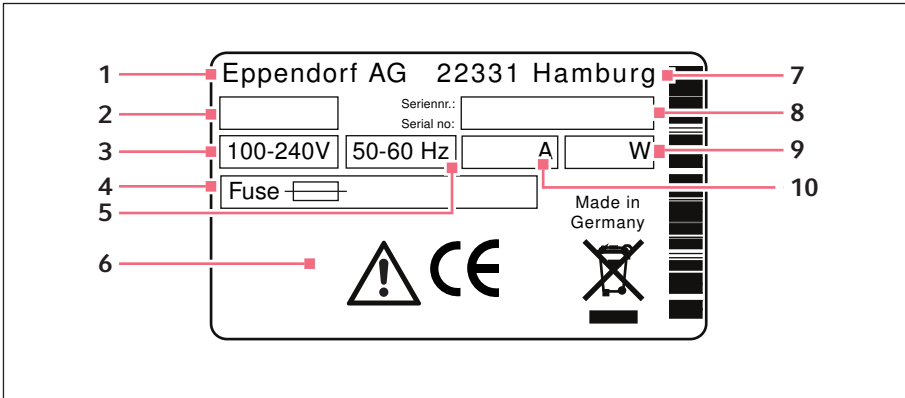

Fig. 3-4: Name plate

- |   |                |    |                         |
|---|----------------|----|-------------------------|
| 1 | Manufacturer   | 6  | Labelings               |
| 2 | Product number | 7  | Address of manufacturer |
| 3 | Voltage        | 8  | Serial number           |
| 4 | Micro fuse     | 9  | Output                  |
| 5 | Frequency      | 10 | Current consumption     |

### 3.6 Control panel

The keys of the control panel are used to switch on the Microinjector, to perform functions, to select programs and to navigate through the menu.

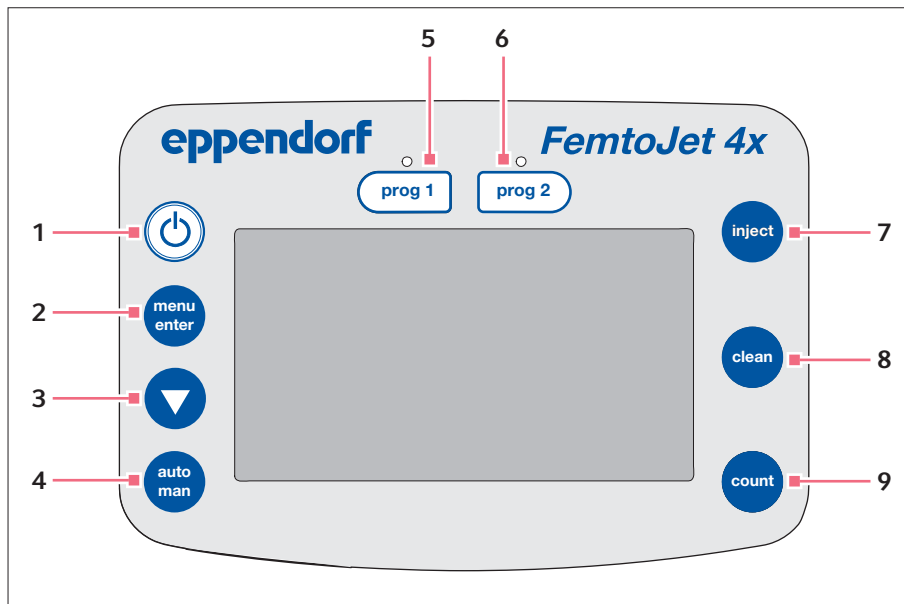

Fig. 3-5: Control panel

- |  |  |
|--|--|
| <p><b>1</b> <i>standby key</i><br/>Activate/deactivate standby mode</p> <p><b>2</b> <i>menu enter key</i><br/>Opens the menu</p> <p><b>3</b> <b>Arrow key</b><br/>Navigating the menu</p> <p><b>4</b> <i>auto man key</i><br/>Toggle between automatic and manual injection</p> <p><b>5</b> <i>prog 1 key</i><br/>Select or save parameter set 1</p> | <p><b>6</b> <i>prog 2 key</i><br/>Select or save parameter set 2</p> <p><b>7</b> <i>inject key</i><br/>Perform an injection</p> <p><b>8</b> <i>clean key</i><br/>Clean the capillary</p> <p><b>9</b> <i>count key</i><br/>Set the counter for performed injections to zero</p> |
|--|--|

**Product description**

FemtoJet® 4x

English (EN)

**3.7 Rotary knobs**

The rotary knobs are used to set the injection parameters as injection time, injection pressure and compensation pressure.

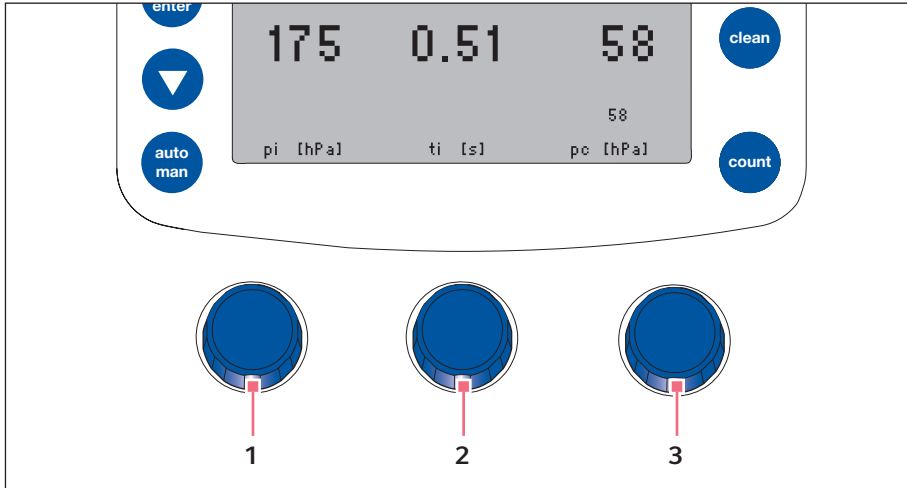

Fig. 3-6: Rotary knobs

**1 Rotary knob**

Set the injection pressure  $p_i$

**2 Rotary knob**

Set the injection time  $t_i$

**3 Rotary knob**

Set the compensation pressure  $p_c$



### 3.8 Foot control

You can connect the foot control to the Microinjector.

The foot control corresponds to the following key on the Microinjector:

- Foot control – *inject* key

**i** The *inject* key remains active when the foot control is connected.

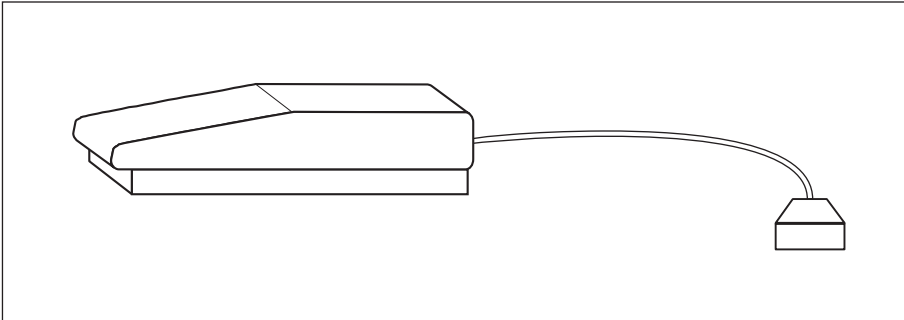

Fig. 3-7: Foot control with plug

### 3.9 Hand control

**i** The hand control is not included in the delivery package and must be ordered separately.

You can connect the hand control to the Microinjector.

The hand controls correspond to the following keys on the Microinjector:

- Left hand control – *inject* key
- Right hand control – *clean* key

**i** The *inject* and *clean* keys remain active when the hand control is connected.

**Product description**

FemtoJet® 4x

English (EN)

**3.10 Pressure tube**

The Microinjector is connected to an external pressure supply with a pressure tube.

- i** The installation only must be realized by qualified staff that has received training on compressed air systems.

You can use the following external pressure supplies:

- Compressor
- Compressed gas cylinder with industrial gas
- In-house compressed air supply

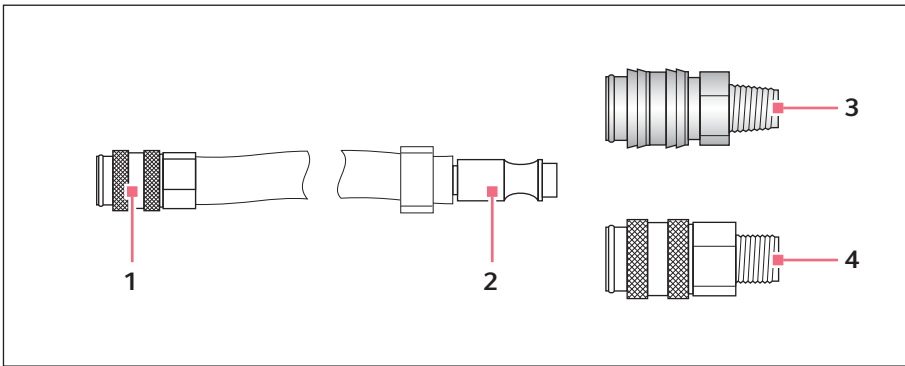
**1 Quick coupling**

Port for Microinjector

**2 Plug****3 Quick coupling**

Brass with conical thread

**4 Quick coupling**

Nickel-plated with cylindrical thread

### 3.11 Injection tube

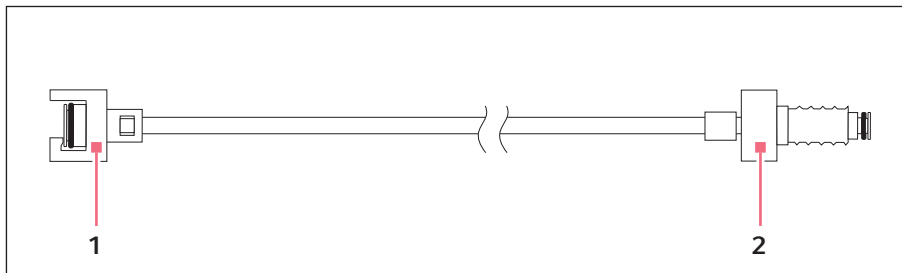

**1 Bayonet coupling**  
FemtoJet connection

**2 Bolted connection**  
Connection for universal capillary holder

### 3.12 Pressure parameters

The parameters are used to define the pressure and time for the injection and the cleaning of the capillary.

The pressure parameters include the following parameters:

- Compensation pressure –  $p_c$
- Injection pressure –  $p_i$
- Injection time –  $t_i$
- Operating pressure
- Rinsing pressure

### 3.12.1 Compensation pressure $p_c$

The compensation pressure prevents the liquid from rising from the Petri dish into the capillary due to the capillary action. Due to the compensation pressure, some liquid will leak constantly from the capillary tip. This prevents the injection material from clumping together.

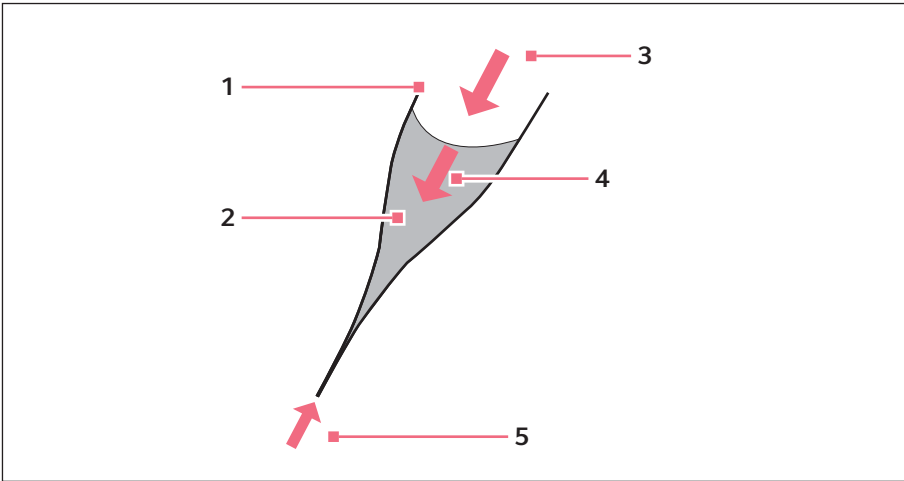

Fig. 3-8: Pressure ratios in the capillary

- |                                  |                        |
|----------------------------------|------------------------|
| 1 Capillary                      | 4 Hydrostatic pressure |
| 2 Liquid with injection material | 5 Capillary action     |
| 3 Compensation pressure $p_c$    |                        |

### 3.12.2 Injection pressure $p_i$

The injection pressure defines the pressure used for injecting liquid into the cell. During the injection process, the injection pressure is applied as long as the injection time is running. To inject liquid into a cell, the injection pressure must be higher than the inside pressure of the cell.

### 3.12.3 Injection time $t_i$

The injection time defines the time period for injecting the liquid. The start of the injection time depends on the presettings of the micromanipulator. The injection time begins either when triggering the injection function or when reaching the lower safety limit. The injection pressure is applied as long as the injection time is running.

### 3.12.4 Rinsing pressure

The rinsing pressure is used to clean the capillary.

### 3.12.5 Operating pressure $p_w$

The operating pressure subsumes the injection pressure, compensation pressure and rinsing pressure.

### 3.13 Self-calibration

The Microinjector performs a calibration every two hours. During the calibration, the ventilation valve opens and the collected condensation water is discharged.

### 3.14 Capillary holder 4

You can insert a capillary or a Femtotips in capillary holder 4.

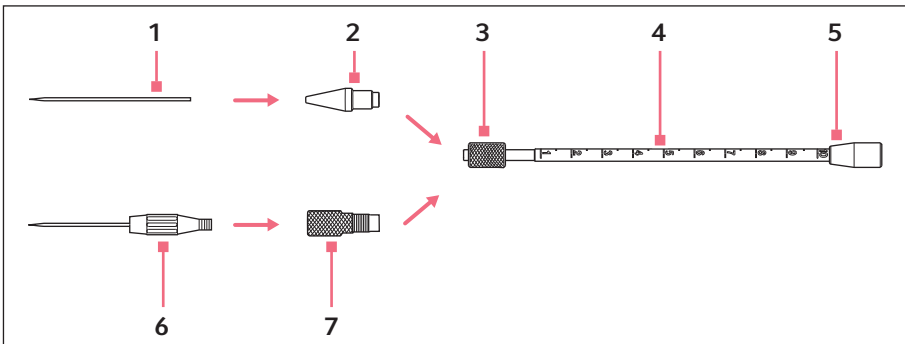

Fig. 3-9: Capillary holder 4

- |                      |                           |
|----------------------|---------------------------|
| 1 Capillary          | 5 Port for injection tube |
| 2 Grip head 4        | 6 Femtotips               |
| 3 Knurled screw      | 7 Adapter for Femtotips   |
| 4 Capillary holder 4 |                           |

**Product description**

FemtoJet® 4x

English (EN)

**3.15 Grip head 4**

The grip head is inserted in the capillary holder. There are different grip head sizes available for different capillary diameters. Grip heads can be differentiated based on the number of grooves they have.

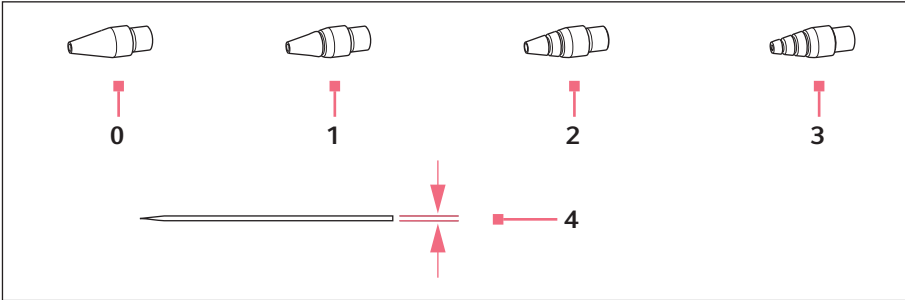

Fig. 3-10: Grip head sizes

**0 Size 0**

For capillary diameters from  
1.0 to 1.1 mm

**1 Size 1**

For capillary diameters from  
1.2 to 1.3 mm

**2 Size 2**

For capillary diameters from  
1.4 to 1.5 mm



**3 Size 3**

For capillary diameters from  
0.7 to 0.9 mm

**4 Capillary diameter**

## 4 Installation

### 4.1 Preparing installation

-  Store the packaging for later transport or storage.
-  In case of visible damages on the Microinjector or the packaging, do not commission the Microinjector.

1. Check the packaging for damage.
2. Check that everything is included in the delivery.
3. Check the Microinjector and the accessories for damages.

#### 4.1.1 Complaints about damages

- ▶ Contact your local Eppendorf distribution partner.

#### 4.1.2 Incomplete delivery

- ▶ Contact your local Eppendorf distribution partner.

## 4.2 Selecting the location

Select the device location according to the following criteria:

- Suitable mains/power connection in accordance with the name plate.
- A bench with a horizontal and even work surface which is designed to support the weight of the device.
- Connection for external compressed air supply according to technical data.

-  The mains/power switch and cutting unit of the mains/power line must be easily accessible during operation (e.g., residual current circuit breaker).

## 4.3 Connecting the external pressure supply

You can use the following external pressure supplies:

- Compressor
- Compressed gas cylinder with industrial gas
- In-house compressed air supply

The external pressure supply must provide a constant pressure within the set pressure limit (see *External compressed air supply on p. 55*). You may use compressed air or nitrogen gas.

The gases must meet the following quality criteria:

- Compressed air – oil-free, clean and dry
- Nitrogen gas – cleaned

### 4.3.1 Preparing the external pressure supply

For connecting the Microinjector, mount the appropriate quick coupling to the pressure supply. The installation only must be realized by qualified staff that has received training on compressed air systems.

Prerequisites

- Quick coupling from brass with conical thread is available (delivery package).
- Nickel plated quick coupling with cylindrical thread is available (delivery package).
- ▶ Install the quick coupling.

### 4.3.2 Connecting the compressor

Prerequisites

- Quick coupling (nickel plated) is mounted to the compressor.
- The Microinjector is switched off.



**CAUTION! Material damage due to contaminated compressed air or compressed gas**

Compressed air containing oil or contaminations will damage the valves and sealings in the Microinjector.

- ▶ Only use oil-free, clean and dry compressed air.
  - ▶ Only use cleaned compressed gas (e.g. nitrogen gas).
- 

1. Connect the pressure tube to the compressor.
2. Connect the pressure tube to the Microinjector.
3. Switch on the compressor.

### 4.3.3 Connecting the compressed gas cylinder

Prerequisites

- Quick coupling (from brass) is mounted to the pressure reducer.
- The valves on the compressed gas cylinder are closed.
- The Microinjector is switched off.



**CAUTION! Material damage due to contaminated compressed air or compressed gas**

Compressed air containing oil or contaminations will damage the valves and sealings in the Microinjector.

- ▶ Only use oil-free, clean and dry compressed air.
  - ▶ Only use cleaned compressed gas (e.g. nitrogen gas).
-



1. Connect the pressure tube to the compressed gas cylinder.
2. Connect the pressure tube to the Microinjector.
3. Open the pressure reducer.

#### 4.3.4 Connecting the in-house compressed air supply

Prerequisites

- Quick coupling (nickel plated) is mounted.
- The Microinjector is switched off.



**CAUTION! Material damage due to contaminated compressed air or compressed gas**

Compressed air containing oil or contaminations will damage the valves and sealings in the Microinjector.

- ▶ Only use oil-free, clean and dry compressed air.
- ▶ Only use cleaned compressed gas (e.g. nitrogen gas).

- 
1. Connect the pressure tube to the in-house pressure supply.
  2. Connect the pressure tube to the Microinjector.
  3. Open the compressed air supply.

#### 4.4 Connecting the Microinjector

Prerequisites

- The external compressed air supply is connected.
- Electrical connection data according to the name plate.
- The Microinjector is switched off.
- ▶ Connect the mains/power cord.

#### 4.5 Inserting o-rings in the grip head

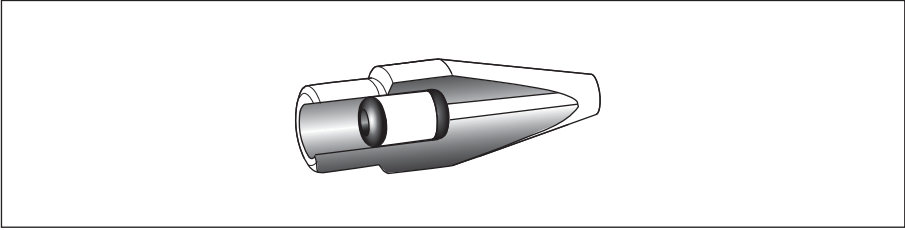
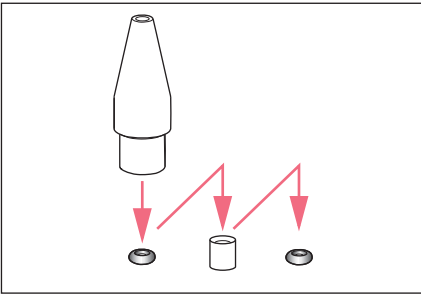

Fig. 4-1: Cross-section of the grip head with correctly inserted o-rings and distancing sleeve

##### Prerequisites

- The o-rings and the distancing sleeve are clean and free of damage.
- The grip head is clean and free of damage.
- A flat and clean surface is available.



1. Place the o-rings and the distancing sleeve on a flat surface.
2. Press the grip head vertically onto the first o-ring and push it into the grip head with the capillary holder.
3. Press the grip head vertically onto the distancing sleeve and push it into the grip head with the capillary holder.
4. Press the grip head vertically onto the second o-ring and push it into the grip head with the capillary holder.

#### 4.6 Connecting an external device

The following devices can be connected to the Microinjector:

- Micromanipulator (InjectMan 4, TransferMan 4r or InjectMan NI 2)
- Computer

#### 4.6.1 Connecting a micromanipulator

##### Prerequisites

- Y-cable FJ4 is available.
- The Microinjector is switched off.
- The micromanipulator is switched off.

 The operation is described in the manual for the micromanipulator.

1. Connect the Y-cable to the MANIPULATOR port.
2. Connect the micromanipulator to the Y-cable.
3. Switch on the Microinjector.  
 The initialization phase starts.  
 After completion of the initialization phase, the main screen appears.

#### 4.6.2 Connecting the PC

##### Prerequisites

- Y-cable FJ4 is available.
- Devices are switched off.

 Control with a PC is described in the **Cell Technology · PC Control** manual.

1. Connect the Y-cable to the MANIPULATOR port.
2. Connect the computer to the Y-cable.
3. Switch on the Microinjector.  
 The initialization phase starts.  
 After completion of the initialization phase, the main screen appears.

#### 4.6.3 Connecting two devices

##### Prerequisites

- Y-cable FJ4 is available.
- Devices are switched off.

Two devices can be connected with the Y-cable FJ4.

The following combinations are possible:

- Computer
- Micromanipulator

 Control with a PC is described in the **Cell Technology · PC Control** manual.

 The operation is described in the manual for the micromanipulator.

1. Connect the Y-cable to the MANIPULATOR port.
2. Connect the computer to the Y-cable.
3. Connect the micromanipulator to the Y-cable.
4. Switch on the Microinjector.  
The initialization phase starts.  
After completion of the initialization phase, the main screen appears.

## **4.7 Connecting accessories**

It is possible to connect the following accessories to the Microinjector:

- Foot control or
- Hand control

### **4.7.1 Connecting a foot control**

Prerequisites

- The Microinjector is switched off.
1. Connect the foot control to the FOOT SWITCH port.

### **4.7.2 Connecting a hand control**

Prerequisites

- The Microinjector is switched off.
- No foot control has been connected.



The hand control is not included in the delivery package and must be ordered separately.

- ▶ Connect the hand control to the FOOT SWITCH port.

## 5 Software

### 5.1 Main screen

The main screen displays all injection parameters, the selected pressure unit, the injection mode and the number of injections.

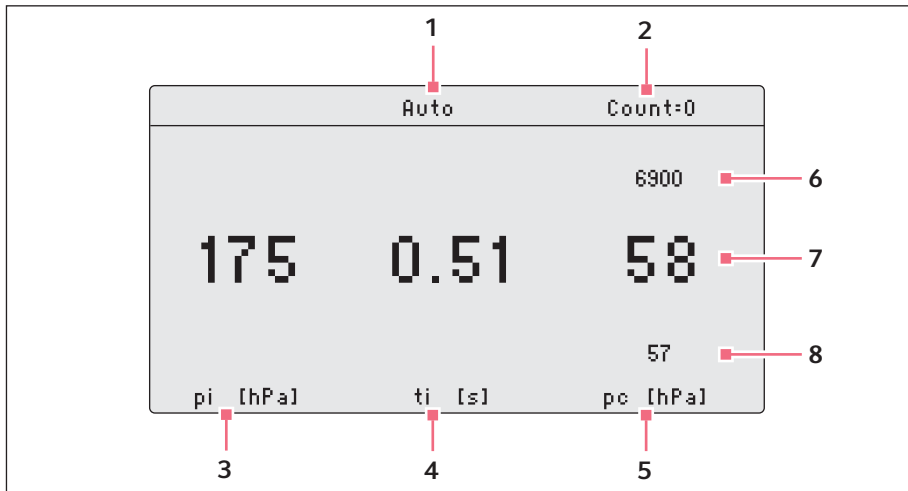

Fig. 5-1: Main screen splitting

- |  |  |
|--|--|
| <p><b>1 Injection mode</b><br/>Automatic or manual injection</p> <p><b>2 Injection counter</b></p> <p><b>3 Parameter for injection pressure <math>p_i</math></b><br/>Pressure unit in hPa or PSI</p> <p><b>4 Parameter for injection time <math>t_i</math></b><br/>Time in seconds</p> | <p><b>5 Parameter for compensation pressure <math>p_c</math></b><br/>Pressure unit in hPa or PSI</p> <p><b>6 External pressure supply</b></p> <p><b>7 Line with set values</b></p> <p><b>8 Line with actual values</b></p> |
|--|--|

## 5.2 Main menu

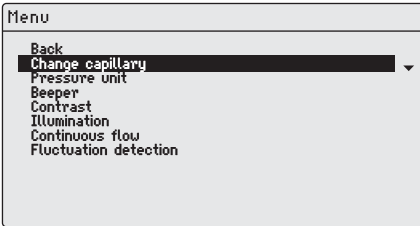
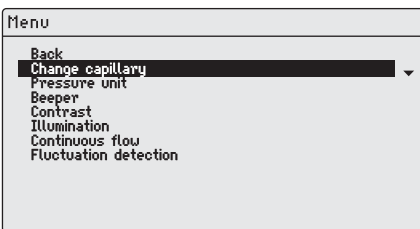

Fig. 5-2: Main menu

Menu	Parameter
<i>Change capillary</i>	Change the capillary.
<i>Pressure unit</i>	Set the unit for pressure (hPa or PSI).
<i>Beeper</i>	Switch on/off the signal tone.
<i>Contrast</i>	Set the display contrast.
<i>Illumination</i>	Switch on/off the display illumination.
<i>Continuous flow</i>	Set a fixed value for a continuous pressure.
<i>Fluctuation detection</i>	Switch on/off the leakage sensors, e.g., to detect capillary breakage.

## 5.3 Navigating in the menu

### 5.3.1 Selecting the menu and navigating



1. Press the *menu enter* key.  
The menu appears.
2. To select a menu entry, press the arrow key.  
The menu entry is shown with a black bar.

### 5.3.2 Exiting the menu

1. Select the submenu *Back*.
2. Press the *menu enter* key.  
The main screen appears.

### 5.3.3 Selecting parameters

#### Prerequisites

- A submenu with parameters is selected.

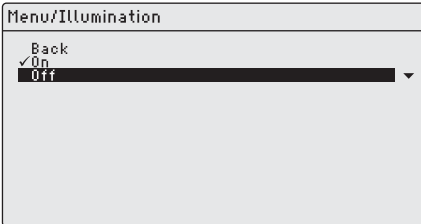

1. To select a parameter, press the arrow key.
2. Confirm with the *menu enter* key.  
The selected parameter is marked with a check mark.  
The main screen appears.

### 5.3.4 Changing a parameter value

#### Prerequisites

- A submenu with parameter values is selected.

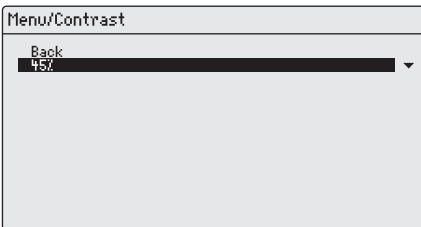

1. For changing a value, use the rotary knob.
2. Confirm with the *menu enter* key.  
The main screen appears.

## 6 Operation

### 6.1 Switching on or off the Microinjector

---



#### **WARNING! Electric shock due to damage to device or mains/power cord.**

- ▶ Only switch on the device if the device and the mains/power cord are undamaged.
  - ▶ Only use devices that have been properly installed or repaired.
  - ▶ In case of danger, disconnect the device from the mains supply. Disconnect the mains/power plug from the device or the earth/grounded socket. Use the isolating device intended for this purpose (e.g., the emergency switch in the laboratory).
- 

#### 6.1.1 Switching on the Microinjector

##### Prerequisites

- External compressed air supply is connected and ready for operation.
1. Take off the injection tube.
  2. Switch on the Microinjector with the mains/power switch.  
The Microinjector performs a self test.  
The main screen appears.

#### 6.1.2 Switching off the Microinjector

1. Switch off the Microinjector with the mains/power switch.
2. Close the external compressed air supply.

### 6.2 Switching on or off the standby mode

For short intermissions, you can use the standby mode. The Microinjector remains ready for operation.

#### 6.2.1 Switching on standby mode

1. Press the *standby* key.
2. Take off the injection tube.  
The display shows *STANDBY*.  
The operating controls are deactivated.

#### 6.2.2 Switching off the standby mode

##### Prerequisites

- The display shows *STANDBY*.
1. Take off the injection tube.
  2. Press the *standby* key.  
The Microinjector performs a short self test.  
The display shows the main screen.



### 6.3 Determining the injection parameters

To determine the correct injection parameters, you can carry out a test injection with fluorescence dye.

#### 6.3.1 Filling the capillaries with fluorescence dye

Prerequisites

- Use a capillary with an opening of 0.5 µm.
  - The injection tube is mounted to the universal capillary holder.
  - Eppendorf pipette and Microloader are available.
1. Fill the Microloader with fluorescing liquid.
  2. Equip the capillary with the Microloader.
  3. Insert the capillary into the universal capillary holder.

#### 6.3.2 Carrying out a test injection

Prerequisites

- The Microinjector and the micromanipulator are connected and ready for operation.
  - The universal capillary holder is prepared with a capillary and fluorescence dye.
  - The universal capillary holder is clamped in the Eppendorf micromanipulator.
  - The Petri dish with adherent cells is prepared.
1. Connect the injection tube to the microinjector.
  2. Define the lower safety limit on the micromanipulator.
  3. Position the capillary above the cell.
  4. Press the *prog 1* key.
  5. Press the *inject* key.
  6. Check the injection visually.

#### 6.3.3 Possible sources of error - cell inflates or bursts

The injected volume is too large.



A volume increase of about 10 % is an appropriate guide value for adherent cells.

1. Decrease the injection pressure or the injection time.
2. Repeat the test injection.

#### 6.3.4 Possible sources of error - capillary is clogged

The injection material has clumped together or an old capillary was used.

1. Press the *clean* key.
2. Repeat the test injection.
3. Replace the capillary if it is not possible to clean it by rinsing.

### 6.3.5 Possible sources of error - liquid is not being injected

The interior cell pressure is higher than the injection pressure.

1. Increase the injection pressure.
2. Repeat the test injection.

### 6.3.6 Possible sources of error - capillary does not reach the cell

The cell is below the lower safety limit (*Z-axis Limit*) of the micromanipulator.

1. Adjust the lower safety limit on the micromanipulator.
2. Repeat the test injection.

### 6.3.7 Result – the injection parameters have been determined

If the correct injection parameters for the current test set-up have been determined, you can continue by performing the injection or you can save the parameter set.

- Saving the injection parameters –  
(see *Saving or changing the injection parameters on p. 38*)
- Performing the injection – (see *Injecting liquid on p. 36*)

## 6.4 Setting the compensation pressure $p_c$

The compensation pressure depends on the surface tension, the viscosity of the injection liquid and the diameter of the capillary opening. The setting of the compensation pressure must provide for a continuous slight leak of liquid at the capillary tip.

Prerequisites

- The injection parameters are known.
- Use a capillary with an opening of 0.5  $\mu\text{m}$ .
- ▶ Set the compensation pressure  $p_c$  with the rotary knob.  
The actual value is shown below the set value.  
The set value is displayed.

## 6.5 Setting the injection pressure $p_i$

The set injection pressure must be higher than the inside pressure of the cell. The injection pressure is built up from the start of the injection time.

Prerequisites

- The injection parameters are known.
- Use a capillary with an opening of 0.5  $\mu\text{m}$ .



Guide values for the injection pressure are 50 hPa to 500 hPa (0.73 PSI to 7.20 PSI).

- ▶ Set the injection pressure  $p_i$  with the rotary knob.

## 6.6 Setting the injection time $t_i$

The injection time and the injection pressure determine the injected volume. The moment from which the injection time is counted depends on the set synchronization mode on the connected micromanipulator.

Beginning of time measurement during synchronization mode:

- *IMMEDIATE* – directly after triggering the injection
- *LIMIT* – when the lower safety limit is reached

Prerequisites

- The injection parameters are known.



Guide values for the injection time are 0.3 – 1.5 seconds.

- ▶ Set the injection time  $t_i$  with the rotary knob.

## 6.7 Setting the injection mode

### 6.7.1 Setting the automatic injection mode

During the automatic injection mode, the set injection time is used. During the injection, the time elapses in reverse and the injection stops at zero.

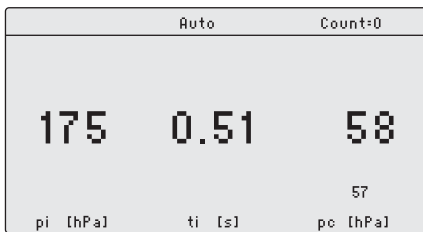

- ▶ Press the *auto man* key.  
The *Auto* injection mode is displayed.  
The injection time is displayed.

### 6.7.2 Setting the manual injection mode

During the manual injection mode, **no** preset injection time is used. The injection only stops when releasing the *inject* key.

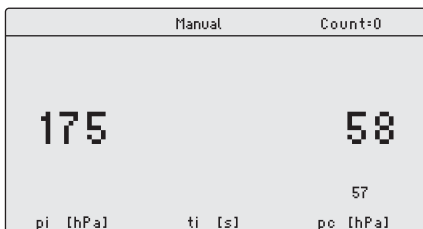

- ▶ Press the *auto man* key.  
The *Manual* injection mode is displayed.  
The injection time only is displayed when pressing the *inject* key.

## 6.8 Injecting liquid

You can trigger an injection with the *inject* key, the foot control or the hand control.

### 6.8.1 Automatically injecting liquid

Prerequisites

- The display shows *Auto*.
  - The injection parameters are set.
  - The micromanipulator is connected.
  - For the synchronization, *IMMEDIATE* is set on the micromanipulator.
- ▶ Press the *inject* key.  
The injection movement is triggered on the micromanipulator.  
The *inject* key is disabled during the injection.  
The elapsing injection time is displayed.

### 6.8.2 Manually injecting liquid

Prerequisites

- The injection parameters are set.
  - The micromanipulator is connected.
  - For the synchronization, *IMMEDIATE* is set on the micromanipulator.
1. Press the *auto man* key.  
The display shows *Manual*.
  2. Keep the *inject* key pressed.  
The injection of the liquid continues until the *inject* key is released.  
The progress of the injection time is displayed.

## 6.9 Replacing the capillary

1. Press the *menu enter* key.
2. Select the *Change capillary* menu.
3. Confirm with the *menu enter* key.  
The message *Capillary may be changed now* is displayed.  
The valve on the injection tube is closed.
4. Replace the capillary on the micromanipulator.
5. Press the *menu enter* key.  
The main screen appears.

## 6.10 Rinsing the capillary

You can rinse a clogged capillary using the cleaning function.

1. Keep the *clean* key pressed.  
The rinsing of the capillary continues until you release the *clean* key.  
The capillary is rinsed at maximum pressure.  
The pressure build-up is shown in a chart.

## 6.11 Setting the injection counter to zero

For each injection performed, the counter is increased by one. You can reset the counter to zero.

1. Press the *count* key.  
The *Count* display is reset to zero.

## 6.12 Calling up saved injection parameters

The program keys are predefined with exemplary parameter sets for standard applications. One parameter set consists of injection pressure, injection time, compensation pressure and injection mode.

The parameter sets are suited for the following standard applications:

- *prog 1* – For adherent cell injection with a capillary diameter of approx. 0.5 µm.
- *prog 2* – For pronucleus injection with a capillary diameter of approx. 0.5 µm.

Parameter set	Injection pressure $P_i$	Injection time $t_i$	Compensation pressure $P_c$	Injection mode
<i>prog 1</i>	150 hPa	0.30 s	50 hPa	<i>Auto</i>
	2.18 PSI	0.30 s	0.73 PSI	
<i>prog 2</i>	110 hPa	–	15 hPa	<i>Manual</i>
	1.60 PSI	–	0.22 PSI	

### 6.12.1 Calling up saved injection parameters

1. Press the *prog 1* or *prog 2* key.  
An acoustic signal will sound.  
The LED above the program key is illuminated.  
The selected program is active.  
The parameter set is displayed.

## 6.13 Saving or changing the injection parameters

You can save individual injection parameters on the two program slots. One parameter set consists of injection pressure, injection time, compensation pressure and injection mode.

### 6.13.1 Saving injection parameters



The current parameter set is overwritten. Please refer to the table for the default parameter sets (Tab. on p. 37).

1. Set the injection parameters.
2. Select the injection mode automatically or manually.
3. Keep the *prog 1* or *prog 2* key pressed for approx. two seconds.  
An acoustic signal will sound.  
The LED above the program key is illuminated.  
The injection parameters are saved.

### 6.13.2 Changing the saved injection parameters



The current parameter set is overwritten. Please refer to the table for the default parameter sets (Tab. on p. 37).

1. Change the injection parameters.
2. Keep the *prog 1* or *prog 2* key pressed for two seconds.  
An acoustic signal will sound.  
The LED above the program key is illuminated.  
The new value is saved.

## 6.14 Adjusting the device settings

### 6.14.1 *Change capillary* function – Changing the capillary

1. Press the *menu enter* key.
2. Select the *Change capillary* menu.
3. Confirm with the *menu enter* key.  
You can change the capillary.
4. Quit the menu with the *menu enter* key.

### 6.14.2 *Pressure unit* function – Selecting the pressure unit

1. Press the *menu enter* key.
2. Select the *Pressure unit* menu.
3. Confirm with the *menu enter* key.
4. Select the pressure unit.
5. Confirm with the *menu enter* key.

### **6.14.3 Beeper function – Switching on/off the signal tone**

1. Press the *menu enter* key.
2. Select the *Beeper* menu.
3. Confirm with the *menu enter* key.
4. Select mode.
5. Confirm with the *menu enter* key.

### **6.14.4 Contrast function – Setting the display contrast**

1. Press the *menu enter* key.
2. Select the *Contrast* menu.
3. Confirm with the *menu enter* key.
4. Set the parameter value with a rotary knob.
5. Confirm with the *menu enter* key.

### **6.14.5 Illumination function – Switching on/off the display illumination**

1. Press the *menu enter* key.
2. Select the *Illumination* menu.
3. Confirm with the *menu enter* key.
4. Select mode.
5. Confirm with the *menu enter* key.

### **6.14.6 Continuous flow function – Setting the constant operating pressure**

1. Press the *menu enter* key.
2. Select the *Continuous flow* menu.
3. Confirm with the *menu enter* key.  
The screen for *Continuous flow* appears.
4. Set the operating pressure  $p_w$  with the rotary knob.
5. Confirm with the *menu enter* key.

## 6.15 Inserting the capillary into the capillary holder

---



### **WARNING! Risk of injury due to flying capillaries and glass splinters.**

If exposed to high pressures, capillaries can detach themselves from the grip heads and become projectiles.

Capillaries can crack as a result of incorrect handling.

- ▶ Wear protective goggles.
  - ▶ Never aim capillaries at people.
  - ▶ Use capillaries with an outer diameter that matches the grip head specifications.
  - ▶ Always mount / dismount capillaries when they are depressurized.
  - ▶ Mount the capillary correctly in the grip head.
  - ▶ Do not touch the capillary with the Petri dish or other objects.
- 

### Prerequisites

- Grip head 0
- Capillary with an outer diameter of 1.0 mm to 1.1 mm

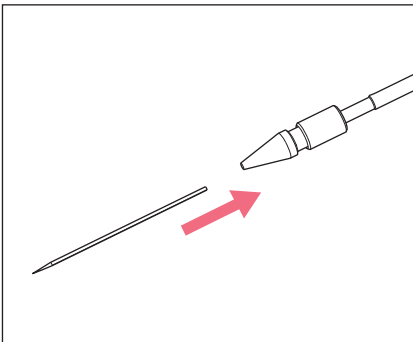

1. Insert the capillary up to the stop.
2. Tighten the grip head.

## 6.16 Inserting Femtotips into the capillary holder

1. Remove the grip head.
2. Screw the adapter for Femtotips into the capillary holder.
3. Screw Femtotips into the adapter and tighten.



## 7 Troubleshooting

### 7.1 General errors

Problem	Cause	Solution
No liquid is injected.	<ul style="list-style-type: none"> <li>• Capillary is clogged.</li> </ul>	<ul style="list-style-type: none"> <li>▶ Clean the capillary using the <i>clean</i> function.</li> <li>▶ If the error persists, replace the capillary.</li> </ul>
Capillary does not reach the injection position.	<ul style="list-style-type: none"> <li>• The lower safety limit is set too high.</li> </ul>	<ul style="list-style-type: none"> <li>▶ Set the lower safety limit on the micromanipulator.</li> </ul>

## 7.2 Error messages

### 7.2.1 Error 01 – 10

Problem	Cause	Solution
Error #01	<ul style="list-style-type: none"> <li>• Software problem</li> </ul>	<ul style="list-style-type: none"> <li>▶ Switch the device off and back on again.</li> <li>▶ If the error persists, please contact the authorized service.</li> </ul>
Error #02	<ul style="list-style-type: none"> <li>• Compressor control signals an unexpected error.</li> </ul>	<ul style="list-style-type: none"> <li>▶ Switch the device off and back on again.</li> <li>▶ If the error persists, please contact the authorized service.</li> </ul>
Error #03	<ul style="list-style-type: none"> <li>• System error</li> </ul>	<ul style="list-style-type: none"> <li>▶ Switch the device off and back on again.</li> <li>▶ If the error persists, please contact the authorized service.</li> </ul>
Error #04	<ul style="list-style-type: none"> <li>• General electronic error in the device.</li> </ul>	<ul style="list-style-type: none"> <li>▶ Switch the device off and back on again.</li> <li>▶ If the error persists, please contact the authorized service.</li> </ul>
Error #05	<ul style="list-style-type: none"> <li>• Faulty hand or foot control.</li> </ul>	<ul style="list-style-type: none"> <li>▶ Switch the device off and back on again.</li> <li>▶ If the error persists, please contact the authorized service.</li> </ul>
Error #06	<ul style="list-style-type: none"> <li>• The keyboard is faulty.</li> </ul>	<ul style="list-style-type: none"> <li>▶ Switch the device off and back on again.</li> <li>▶ If the error persists, please contact the authorized service.</li> </ul>

<b>Problem</b>	<b>Cause</b>	<b>Solution</b>
Error #07	<ul style="list-style-type: none"> <li>• System error</li> </ul>	<ul style="list-style-type: none"> <li>▶ Switch the device off and back on again.</li> <li>▶ If the error persists, please contact the authorized service.</li> </ul>
Error #08	<ul style="list-style-type: none"> <li>• Injection pressure control signals an unexpected error.</li> </ul>	<ul style="list-style-type: none"> <li>▶ Switch the device off and back on again.</li> <li>▶ If the error persists, please contact the authorized service.</li> </ul>
Error #09	<ul style="list-style-type: none"> <li>• Pressure reservoir control signals an unexpected error.</li> </ul>	<ul style="list-style-type: none"> <li>▶ Switch the device off and back on again.</li> <li>▶ If the error persists, please contact the authorized service.</li> </ul>
Error #10	<ul style="list-style-type: none"> <li>• Safety monitor signals an unexpected error.</li> </ul>	<ul style="list-style-type: none"> <li>▶ Switch the device off and back on again.</li> <li>▶ If the error persists, please contact the authorized service.</li> </ul>

### 7.2.2 Error 11 – 18

<b>Problem</b>	<b>Cause</b>	<b>Solution</b>
Error #11	<ul style="list-style-type: none"> <li>• Serial interface RS232 signals an unexpected error.</li> </ul>	<ul style="list-style-type: none"> <li>▶ Switch the device off and back on again.</li> <li>▶ If the error persists, please contact the authorized service.</li> </ul>
Error #12	<ul style="list-style-type: none"> <li>• The voltage control signals an unexpected error.</li> </ul>	<ul style="list-style-type: none"> <li>▶ Switch the device off and back on again.</li> <li>▶ If the error persists, please contact the authorized service.</li> </ul>
Error #13	<ul style="list-style-type: none"> <li>• The compressor does not work or is faulty.</li> </ul>	<ul style="list-style-type: none"> <li>▶ Switch the device off and back on again.</li> <li>▶ If the error persists, please contact the authorized service.</li> </ul>
Error #14	<ul style="list-style-type: none"> <li>• Pressure control is faulty.</li> </ul>	<ul style="list-style-type: none"> <li>▶ Switch the device off and back on again.</li> <li>▶ If the error persists, please contact the authorized service.</li> </ul>

<b>Problem</b>	<b>Cause</b>	<b>Solution</b>
Error #15	<ul style="list-style-type: none"> <li>• System error</li> </ul>	<ul style="list-style-type: none"> <li>▶ Switch the device off and back on again.</li> <li>▶ If the error persists, please contact the authorized service.</li> </ul>
Error #16	<ul style="list-style-type: none"> <li>• System error</li> </ul>	<ul style="list-style-type: none"> <li>▶ Switch the device off and back on again.</li> <li>▶ If the error persists, please contact the authorized service.</li> </ul>
Error #17	<ul style="list-style-type: none"> <li>• An open injection tube is connected.</li> </ul>	<ul style="list-style-type: none"> <li>▶ Take off the injection tube.</li> <li>▶ Connect the injection tube to the capillary holder.</li> <li>▶ Connect the injection tube.</li> <li>▶ Switch the device off and back on again.</li> <li>▶ If the error persists, please contact the authorized service.</li> <li>▶ Check the assemblies.</li> <li>▶ Exchange any faulty assemblies.</li> </ul>
Error #18	<ul style="list-style-type: none"> <li>• An open injection tube is connected.</li> </ul>	<ul style="list-style-type: none"> <li>▶ Take off the injection tube.</li> <li>▶ Connect the injection tube to the capillary holder.</li> <li>▶ Connect the injection tube.</li> <li>▶ Switch the device off and back on again.</li> <li>▶ If the error persists, please contact the authorized service.</li> </ul>

### 7.2.3 Error 19 – 38

Problem	Cause	Solution
Error #19	• System error	<ul style="list-style-type: none"> <li>▶ Switch the device off and back on again.</li> <li>▶ If the error persists, please contact the authorized service.</li> </ul>
Error #20	• System error	
Error #21	• System error	
Error #22	• System error	
Error #23	• System error	
Error #24	• System error	
Error #25	• System error	
Error #26	• System error	
Error #27	• System error	
Error #28	• System error	
Error #29	• System error	
Error #30	• System error	
Error #31	• System error	
Error #32	• System error	
Error #33	• System error	
Error #34	• System error	
Error #35	• System error	
Error #36	• System error	
Error #38	• System error	

### 7.2.4 Warnings 37 – 40

Problem	Cause	Solution
Warning #37	<ul style="list-style-type: none"> <li>• Micromanipulator is not connected correctly.</li> </ul>	<ul style="list-style-type: none"> <li>▶ Press the <i>menu enter</i> key.</li> <li>▶ Check the micromanipulator.</li> <li>▶ Check the connecting cable.</li> <li>▶ If the error persists, please contact the authorized service.</li> </ul>
	<ul style="list-style-type: none"> <li>• Micromanipulator is performing another action or requires too much time to perform the action.</li> </ul>	<ul style="list-style-type: none"> <li>▶ Press the <i>menu enter</i> key.</li> <li>▶ Wait for the micromanipulator to complete the action.</li> <li>▶ Shorten the traveling distance of the micromanipulator by bringing the capillary closer to the Z-limit.</li> <li>▶ If applicable, set the parameter <i>Synchr. inject</i> at the micromanipulator to the value <i>IMMEDIATE</i>.</li> <li>▶ If applicable, extend the injection time <math>t_i</math>.</li> </ul>

Problem	Cause	Solution
Warning #39	<ul style="list-style-type: none"> <li>• Capillary is broken.</li> </ul>	<ul style="list-style-type: none"> <li>▶ Insert a new capillary.</li> </ul>
	<ul style="list-style-type: none"> <li>• Injection tube is not separated from the device when switching on.</li> </ul>	<ul style="list-style-type: none"> <li>▶ Take off the injection tube.</li> <li>▶ Wait until the initialization phase is completed.</li> <li>▶ Connect the injection tube.</li> </ul>
	<ul style="list-style-type: none"> <li>• Injection tube connected without equipped capillary.</li> </ul>	<ul style="list-style-type: none"> <li>▶ Connect an equipped capillary.</li> </ul>
	<ul style="list-style-type: none"> <li>• Leak in the area of the capillary, capillary holder, injection tube or their connections.</li> </ul>	<ul style="list-style-type: none"> <li>▶ Check all connections and seals from the FemtoJet to the capillary.</li> <li>▶ Exchange defective o-rings.</li> </ul>
	<ul style="list-style-type: none"> <li>• Warning appears immediately when connecting the tube.</li> </ul>	<ul style="list-style-type: none"> <li>▶ Connect the tube by means of the <i>Change capillary</i> function.</li> <li>▶ Switch off <i>Fluctuation detection</i> function.</li> </ul>
	<ul style="list-style-type: none"> <li>• Storage pressure is too low.</li> </ul>	<ul style="list-style-type: none"> <li>▶ Wait until the storage pressure is reached.</li> </ul>
	<ul style="list-style-type: none"> <li>• System error</li> </ul>	<ul style="list-style-type: none"> <li>▶ Switch the device off and back on again.</li> <li>▶ If the error persists, please contact the authorized service.</li> </ul>

Problem	Cause	Solution
Warning #40	<ul style="list-style-type: none"> <li>• Capillary is broken.</li> </ul>	<ul style="list-style-type: none"> <li>▶ Insert a new capillary.</li> </ul>
	<ul style="list-style-type: none"> <li>• Injection tube is not separated from the device when switching on.</li> </ul>	<ul style="list-style-type: none"> <li>▶ Take off the injection tube.</li> <li>▶ Wait until the initialization phase is completed.</li> <li>▶ Connect the injection tube.</li> </ul>
	<ul style="list-style-type: none"> <li>• Injection tube connected without equipped capillary.</li> </ul>	<ul style="list-style-type: none"> <li>▶ Connect an equipped capillary.</li> </ul>
	<ul style="list-style-type: none"> <li>• Leak in the area of the capillary, holder, injection tube or their connections.</li> </ul>	<ul style="list-style-type: none"> <li>▶ Check all connections and seals from the FemtoJet to the capillary.</li> <li>▶ Exchange defective o-rings.</li> </ul>
	<ul style="list-style-type: none"> <li>• Warning appears immediately when connecting the tube.</li> </ul>	<ul style="list-style-type: none"> <li>▶ Connect the tube by means of the <i>Change capillary</i> function.</li> <li>▶ Switch off <i>Fluctuation detection</i> function.</li> </ul>
	<ul style="list-style-type: none"> <li>• Storage pressure is too low.</li> </ul>	<ul style="list-style-type: none"> <li>▶ Wait until the storage pressure is reached.</li> </ul>
	<ul style="list-style-type: none"> <li>• System error</li> </ul>	<ul style="list-style-type: none"> <li>▶ Switch the device off and back on again.</li> <li>▶ If the error persists, please contact the authorized service.</li> </ul>

## 8 Maintenance

### 8.1 Exchanging the o-rings in the grip head

If you notice leaks on the grip head, the o-rings must be exchanged.

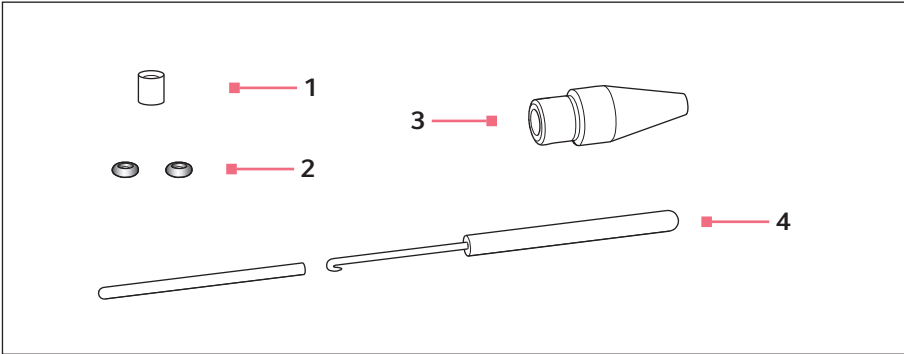

Fig. 8-1: Grip head 4 with removal tool

**1 Distance sleeve**

**2 O-rings**

Inner diameter 1.0 mm

**3 Grip head 4 size 0**

**4 Removal tool**

Hook with protective sleeve

#### 8.1.1 Remove the o-rings and distancing sleeves

Prerequisites

- The grip head has been unscrewed from the capillary holder.
- The capillary has been removed from the grip head.

The hook of the removal tool is used to pull out the o-rings and the distance sleeve.

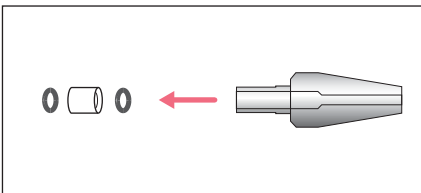

1. Pull out the first o-ring.
2. Pull out the distance sleeve.
3. Pull out the second o-ring.



## 8.1.2 Inserting the o-rings and the distance sleeve

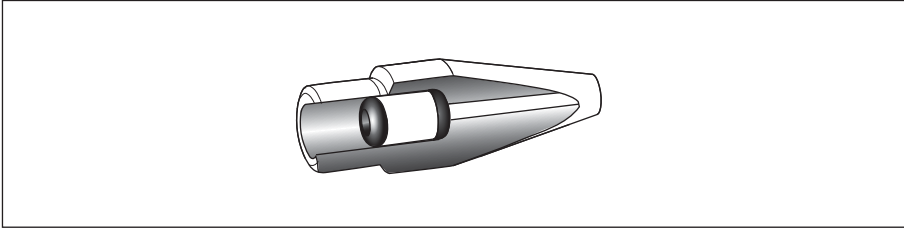
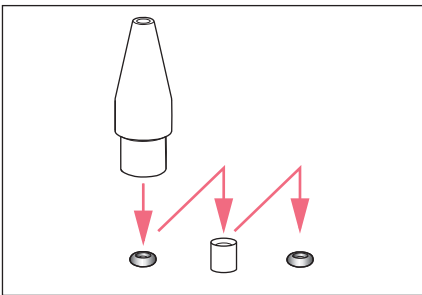

Fig. 8-2: Cross section with correctly positioned o-rings and spacing sleeve

### Prerequisites

- The o-rings are clean and free of damage.
- The grip head is clean and free of damage.
- A clean and flat surface is available.
- O-rings matching the grip head size are available.



1. Place the new o-rings and the distance sleeve on a flat surface.
2. Press the grip head vertically onto the first o-ring and push the o-ring into the grip head using the capillary holder.
3. Press the grip head vertically onto the distance sleeve and push the distance sleeve into the grip head using the capillary holder.
4. Press the grip head vertically onto the second o-ring and push the o-ring into the grip head using the capillary holder.

## 8.2 Exchanging the o-ring in the Femtotips adapter

If the o-ring is defective and leaky, it must be exchanged.

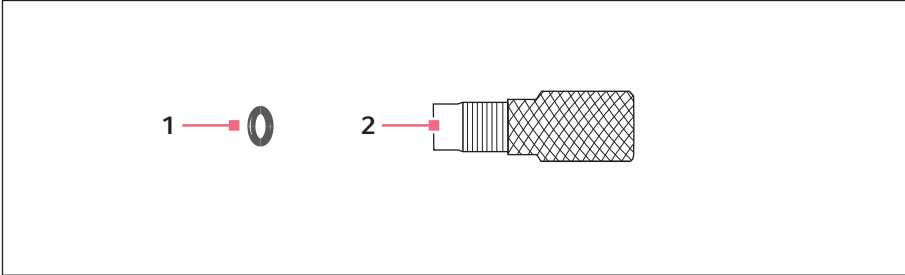

Fig. 8-3: Adapter for Femtotips

### 1 O-ring

Inner diameter 1.5 mm

### 2 Adapter

### 8.2.1 Exchanging the o-ring

Prerequisites

- An o-ring with an inner diameter of 1.5 mm is prepared.
- Femtotips is removed.

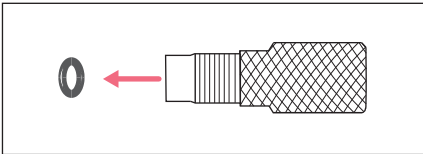

- ▶ Extract the o-ring with the hook of the removal tool.

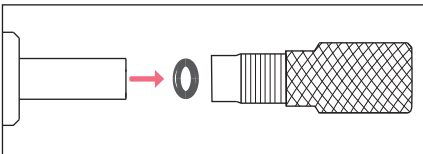

- ▶ Insert the new o-ring and push it into the adapter with the capillary holder.

### 8.3 Replacing fuses



**DANGER! Electric shock.**

- ▶ Switch off the device and disconnect the power plug before starting maintenance or cleaning work.

The fuse holder is located between the mains connection socket and the mains power switch. The fuses may only be replaced with the same type of fuse.

1. Disconnect the mains plug.
2. Pull the fuse holder out completely.
3. Replace the defective fuse.
4. Insert the fuse holder.

### 8.4 Cleaning



**DANGER! Electric shock due to the ingress of liquid.**

- ▶ Switch off the device and disconnect the power plug before starting cleaning or disinfection work.
- ▶ Do not allow any liquids to penetrate the inside of the housing.
- ▶ Do not spray clean/spray disinfect the housing.
- ▶ Only plug the device back in if it is completely dry, both inside and outside.



**NOTICE! Damage from the use of aggressive chemicals.**

- ▶ Do not use any aggressive chemicals on the device or its accessories, such as strong and weak bases, strong acids, acetone, formaldehyde, halogenated hydrocarbons or phenol.
- ▶ If the device has been contaminated by aggressive chemicals, clean it immediately using a mild cleaning agent.



Clean the device at least every 4 weeks.

1. Wipe the painted parts and the aluminum surfaces with a cloth and mild detergent.
2. Polish with a dry cloth.

## 8.5 Disinfection/decontamination

-  ▶ Select disinfection methods that comply with the legal regulations and guidelines for your area of application.
- ▶ If you have any questions regarding cleaning, disinfection and decontamination, please contact Eppendorf AG.

Prerequisites

- All device parts are cleaned.
- A disinfectant containing alcohol (such as isopropanol or spirit) is available.
- ▶ Wipe all parts of the device with a cloth and the disinfectant.

## 8.6 Hints with regard to service intervals

The display shows the following message:

- *Please contact local service soon* – Contact the authorized service.
- *Please contact local service now* – Have the service performed by the authorized service.

## 8.7 Service and maintenance

Application-specific service and safety inspections are not required.

-  Software updates may only be performed by authorized service personnel.

The Eppendorf AG service team is available to service and certify your device.

Service provisions:

- Service
- Operational qualification (OQ) according to manufacturer's specifications
- Electrical safety testing according to country-specific regulations
- Software update

Information on the services offered can be found on our webpage:

[www.eppendorf.com/epservices](http://www.eppendorf.com/epservices).

## 9 Technical data

### 9.1 Mode of operation

Mode of operation	S1 (IEC 60034-1)
-------------------	------------------

### 9.2 Weight/dimensions

Width	213 mm
Depth	207 mm
Height	250 mm
Weight	3.5 kg

### 9.3 Power supply

Voltage	100 V – 240 V, AC, 10 %
Frequency	50 Hz – 60 Hz
Power consumption	40 W
Protection class	I
Overvoltage category	II (IEC 61010-1)
Micro fuse	T 2.5 A/250 V

## 9.4 Interfaces

### 9.4.1 USB

Type	Slave
Use	Service

### 9.4.2 RS 232

Baud rate	9600
Start bit	1
Data bits	8
Parity	none
Stop bit	2

**Technical data**

FemtoJet® 4x

English (EN)

**9.4.3 Injection time  $t_i$** 

Time interval	0.10 s – 99.99 s
Increment	0.01 s

**9.4.4 Injection pressure  $p_i$** 

Pressure range, controlled	5 hPa – 6000 hPa
	0.07 PSI – 87.0 PSI
Increment	1 hPa
	0.01 PSI
Pressure, uncontrolled	0 hPa
	0 PSI

**9.4.5 Compensation pressure  $p_c/p_w$** 

Pressure range, controlled	5 hPa – 6000 hPa
	0.07 PSI – 87.0 PSI
Increment	1 hPa
	0.01 PSI
Pressure, uncontrolled	0 hPa
	0 PSI

**9.4.6 Rinsing pressure**

Pressure range	4000 hPa – 6000 hPa
	58.01 PSI– 87.02 PSI

### 9.4.7 Accuracy

6000 hPa 87.02 PSI	±8 hPa
	±0.12 PSI
2500 hPa 36.26 PSI	±6 hPa
	±0.09 PSI
1000 hPa 14.50 PSI	±3 hPa
	±0.04 PSI
100 hPa 1.45 PSI	±2 hPa
	±0.03 PSI
50 hPa 0.73 PSI	±1 hPa
	±0.01 PSI
15 hPa 0.22 PSI	±1 hPa
	±0.01 PSI

### 9.5 External compressed air supply

Pressure range	4000 hPa – 8000 hPa
	60 PSI – 120 PSI
Connection	G 1/4"
Source of compressed gas	Compressor, compressed gas cylinder, in-house compressed air supply
Compressed gas	Compressed air, nitrogen

### 9.6 Ambient conditions

Ambience	Only for use indoors.
Ambient temperature	15 °C – 40 °C
Relative humidity	10 % – 75 %, non-condensing.
Atmospheric pressure	795 hPa – 1060 hPa Use up to a height of 2000 m above sea level.
Degree of pollution	2 (IEC 664)

## 10 Transport, storage and disposal

### 10.1 Storage

	Air temperature	Relative humidity	Atmospheric pressure
In transport packaging	-20 °C – 70 °C	10 % – 80 %	300 hPa – 1060 hPa
Without transport packaging	–	–	–

### 10.2 Decontamination before shipment

If you are shipping the device to the authorized Technical Service for repairs or to your authorized dealer for disposal please note the following:



#### **WARNING! Risk to health from contaminated device**

1. Observe the information on the decontamination certificate. You can find it as a PDF document on our webpage ([www.ependorf.com/decontamination](http://www.ependorf.com/decontamination)).
2. Decontaminate all the parts you would like to dispatch.
3. Include the fully completed decontamination certificate in the package.

### 10.3 Transport

	Air temperature	Rel. humidity	Atmospheric pressure
General transport	-25 °C – 60 °C	10 % – 95 %	30 kPa – 106 kPa
Air freight	-40 °C – 55 °C	10 % – 95 %	30 kPa – 106 kPa

Carry out the following steps before transport:

1. Pull off the rotary knobs and pack them separately in the provided bag.
2. Pack the Microinjector in the original packaging.
3. Only use the original packaging for transporting the Microinjector.



## 10.4 Disposal

In case the product is to be disposed of, the relevant legal regulations are to be observed.

### **Information on the disposal of electrical and electronic devices in the European Community:**

Within the European Community, the disposal of electrical devices is regulated by national regulations based on EU Directive 2012/19/EU pertaining to waste electrical and electronic equipment (WEEE).

According to these regulations, any devices supplied after August 13, 2005, in the business-to-business sphere, to which this product is assigned, may no longer be disposed of in municipal or domestic waste. To document this, they have been marked with the following identification:



Because disposal regulations may differ from one country to another within the EU, please contact your supplier if necessary.

**Ordering information**FemtoJet® 4x  
English (EN)**11 Ordering information****11.1 FemtoJet 4x**

<b>Order no. (International)</b>	<b>Order no. (North America)</b>	<b>Description</b>
5253 000.017	5253000017	<b>FemtoJet 4x Microinjector</b>

**11.2 Accessories for FemtoJet 4x**

<b>Order no. (International)</b>	<b>Order no. (North America)</b>	<b>Description</b>
5192 082.007	5192082007	<b>Connecting cable</b> TransferMan 4r/InjectMan 4 - FemtoJet 4i/4x
5252 070.038	5252070038	<b>Connecting cable</b> InjectMan NI 2 - FemtoJet 4i/4x
5252 070.011	5252070011	<b>Hand control</b> for remote-controlling for FemtoJet 4i/4x
5252 070.020	5252070020	<b>Foot control</b> for FemtoJet 4i/4x
5192 080.004	5192080004	<b>Y-cable FJ4</b>
5248 200.008	920011993	<b>pressure tube</b> for connecting the FemtoJet express/4x to an external pressure supply Length 2.5 m, incl. 2 couplings G 1/4 inch and 1/ 4 inch 18 NPT
5252 070.054	5252070054	<b>Injection tube</b> 2 m, for universal capillary holder and capillary holder 4
5248 202.000	920011985	<b>Adapter for nitrogen pressure reducer</b> Coupling G 1/4 inch 18 NPT
5252 070.046	5252070046	<b>O-ring</b> for injection tube

### 11.3 Capillary holders 4 and grip heads 4

Order no. (International)	Order no. (North America)	Description
5196 081.005	5196081005	<b>Capillary holder 4</b> for mounting microcapillaries, Femtotips, Femtotip II or grip head 4 (incl. Grip head 4 size 0 and adapter for Femtotips)
5196 082.001	5196082001	<b>Grip head set 4</b> size 0
5196 083.008	5196083008	size 1
5196 084.004	5196084004	size 2
5196 085.000	5196085000	size 3
5196 062.000	5196062000	<b>Capillary holder 4, slim shape</b> incl. grip head set 4, for capillaries with outer diameter 1.0 mm
5196 063.007	5196063007	<b>Grip head set 4, slim shape</b> for Capillary holder 4 (slim shape), incl. 6 o-rings and 2 distance sleeves, for capillaries with outer diameter 1.0 mm
5196 086.007	5196086007	<b>O-ring set 4</b> incl. 10 o-rings large, 10 o-rings small, 2 distance sleeves, o-ring removal tool for grip head set 4

### 11.4 Capillaries

Order no. (International)	Order no. (North America)	Description
5242 952.008	930000035	<b>Femtotips</b> 20 pieces
5242 957.000	930000043	<b>Femtotip II</b> 20 pieces
5242 956.003	930001007	<b>Microloader</b> Eppendorf Quality, 2 racks of 96 tips 0.5 - 20 µL, light gray, length: 100 mm

**Index****A**

Ambient conditions ..... 55

**C**

Capillary

Cleaning ..... 37

Cleaning ..... 51

Compensation pressure

Setting ..... 34

Connection

Accessories ..... 28

Compressed air supply ..... 25

Compressed gas cylinder ..... 24

Compressor ..... 24

Computer ..... 27

Device combination ..... 27

External device ..... 26

External pressure supply ..... 23

Foot control ..... 28

Hand control ..... 28

Micromanipulator ..... 27

Pressure supply ..... 23

**D**

Decontamination ..... 56

Device settings

Functions ..... 38

Disinfectant ..... 52

Disposal ..... 57

Distance sleeve ..... 48

**F**

Fluorescence dye

Test injection ..... 33

Foot control ..... 17

Function

Beeper ..... 39

Change capillary ..... 38

Continuous flow ..... 39

*Contrast* ..... 39

Device settings ..... 38

*Illumination* ..... 39*Pressure unit* ..... 38**H**

Hand control

Accessories ..... 17

**I**

Injection

Liquid ..... 36

Injection counter ..... 37

Injection mode ..... 35

automatic ..... 35

manual ..... 35

Injection parameters

Compensation pressure ..... 20

Injection pressure ..... 20

Injection time ..... 20

Result ..... 34

Injection pressure

Setting ..... 34

Injection time

Setting ..... 35

Installation

Selecting the location ..... 23

Intermissions

Standby ..... 32

**M**

Main menu ..... 30

main screen ..... 29

**N**

Navigation

Menu ..... 30

**O**

O-ring ..... 48

**P**

- Parameter change ..... 31
- Parameter selection ..... 31
- Parameter set
  - prog 1* ..... 37
  - prog 2* ..... 37
- Possible sources of error
  - Capillary clogged ..... 33
  - Cell bursts ..... 33
  - Limit ..... 34
  - No injection ..... 34
  - Test injection ..... 33, 34
- Pressure parameters ..... 19
  - Operating pressure ..... 21
  - Rinsing pressure ..... 21
- Pressure supply
  - Connection ..... 23
- Program key
  - prog 1* ..... 37
  - prog 2* ..... 37

**S**

- Selecting the location ..... 23
- Service
  - Safety inspections ..... 52
  - Service provisions ..... 52
- Service interval ..... 52
- Setting
  - Compensation pressure ..... 34
  - Injection mode ..... 35
  - Injection pressure ..... 34
  - Injection time ..... 35
- Standby ..... 32
- Standby mode ..... 32
- Storage ..... 56
- Switching off ..... 32
- Switching on ..... 32
- Synchronization
  - Micromanipulator ..... 35

**T**

- Test injection
  - Injection parameters ..... 33

**U**

- Unpacking ..... 23



# Declaration of Conformity

The product named below fulfills the requirements of directives and standards listed. In the case of unauthorized modifications to the product or an unintended use this declaration becomes invalid.

**Product name:**

FemtoJet® 4x, FemtoJet® 4i

**Product type:**

Microinjector for cell biology

**Relevant directives / standards:**

2014/35/EU: EN 61010- 1  
UL 61010- 1, CAN/CSA C22.2 No. 61010- 1  
2014/30/EU: EN 55011, EN 61326- 1  
2011/65/EU EN 50581

Date: May 30, 2016



Management Board



Portfolio Management

Your local distributor: [www.eppendorf.com/contact](http://www.eppendorf.com/contact)  
Eppendorf AG · 22331 Hamburg · Germany  
[eppendorf@eppendorf.com](mailto:eppendorf@eppendorf.com)

Eppendorf® and the Eppendorf logo are registered trademarks of Eppendorf AG, Germany.  
U.S. Design Patents are listed on [www.eppendorf.com/ip](http://www.eppendorf.com/ip).  
All rights reserved, incl. graphics and pictures. Copyright 2016 © by Eppendorf AG.

[www.eppendorf.com](http://www.eppendorf.com)

ISO 9001  
Certified

ISO  
13485  
Certified

ISO  
14001  
Certified







# Evaluate Your Manual

Give us your feedback.  
[www.eppendorf.com/manualfeedback](http://www.eppendorf.com/manualfeedback)

**Your local distributor: [www.eppendorf.com/contact](http://www.eppendorf.com/contact)**  
Eppendorf AG · Barkhausenweg 1 · 22339 Hamburg · Germany  
[eppendorf@eppendorf.com](mailto:eppendorf@eppendorf.com) · [www.eppendorf.com](http://www.eppendorf.com)