



Thermo Scientific Orion Star A320 Series

Electrochemistry Portable Meters

68X000443 • Revision A • June 2015

Thermo
SCIENTIFIC



Important Note

Please read this user guide thoroughly before using your meter. Any use outside of these instructions may invalidate your warranty and cause permanent damage to the meter.

Contact Information

For assistance with Thermo Scientific™ Orion™ products, contact Technical Support by email at wai.techservbev@thermofisher.com or by phone – within the United States call 1-800-225-1480 and outside the United States call +1-978-232-6000 or fax +1-978-232-6031.

For additional product information, contact your local authorized dealer, local Thermo Scientific Orion technical sales representative or contact us using the Water and Laboratory Products (WLP) information on the page back of this manual.

Applications and Technical Resources

Visit www.thermoscientific.com/water to view Thermo Scientific Orion products and download product literature, user guides and manuals, software updates, and the latest application and technical resources.

Table of Contents

Chapter 1	6
Meter Introduction	6
Meter Overview.....	6
Packing List	8
Intended Use	9
Chapter 2	10
Meter Basics	10
Installing Batteries	10
Using the Universal Power Adapter (Optional Power Source).....	11
Portable Meter Accessories	12
Orion Star A Series Portable Meter Armor	12
Orion Star A Series Portable Meter Field Case.....	13
Meter Connections.....	14
Meter Keypad	17
Function Keys	18
Meter Display.....	19
Measurement Display Icons.....	21
pH Electrode Condition Icon.....	22
Meter Models and Measurement Capabilities.....	23
Meter Maintenance	23
Chapter 3	24
Meter Setup Menus	24
Main Setup Menu.....	24
General Setup Menu Navigation	24
Channel-Specific Method, Mode and Temperature Menus.....	28
Method Menu	29
Mode and Settings Menu	32
Temperature Menu.....	46
Instrument Settings Setup Menu.....	51
Log View Menu.....	52
Data Log.....	52
Calibration Log.....	53
Diagnostics Menu	54
Meter Self Test Procedure	54
Electrode Stability Test Procedure	55
Chapter 4	56
Using the pH or pH/ISE Channel	56
Meter and Electrode Preparation.....	56
pH Calibration Procedure	57
pH Calibration Editing.....	58
ORP Calibration Procedure (Relative mV Mode).....	59
ORP Calibration Procedure (E _H Units).....	60
ISE Calibration Procedure	61
ISE Calibration Editing	62
Measurement Procedure	63

Chapter 5	64
Using the Conductivity Channel	64
Meter and Sensor Preparation.....	64
Conductivity Calibration Procedure.....	65
Conductivity Calibration Editing.....	66
Alternative Certified Cell Constant Entry Calibration Procedure	66
Conductivity Standards vs. Temperature Table.....	67
Conductivity Meter Verification Procedure.....	68
Measurement Procedure	69
Chapter 6	70
Using the DO/RDO Channel	70
Meter and Sensor Preparation.....	70
Dissolved Oxygen Calibration Procedure	71
Air (Water-saturated Air) Calibration	72
Water (Air-saturated Water) Calibration	72
Manual (Winkler) Calibration	73
Set Zero Calibration	74
Measurement Procedure	75
Chapter 7	76
Data Transfer and Software Updates	76
Data Storage and Transfer Settings	76
Measurement Read Type Setting.....	76
Data Log Setting	77
Export Data Settings	78
Printer Compatibility and Requirements	80
Computer Compatibility and Requirements	81
Using the USB-to-Serial Computer Cable	82
Using the USB Computer Cable.....	84
Orion Star Com Communication Software	87
Meter Interfacing with Other Computer Programs.....	88
Star A200-A300 Meter Remote Control Protocols.....	89
Meter Software Upgrade Procedure	96
Chapter 8	100
Customer Services	100
Troubleshooting Tips	101
Meter Factory Reset Procedure	102
Meter User Reset Procedure.....	102
Notice of Compliance.....	103
WEEE Compliance	103
Declaration of Conformity	104
Meter Specifications	105
Ordering Information.....	114
Meter Accessories, Electrodes and Solutions	115

1

CHAPTER 1 **Meter Introduction**

Meter Overview

Thermo Scientific™ Orion Star™ A320 series portable meters feature a rugged, robust IP67-rated waterproof meter housing for testing in a variety of outdoor and challenging environments. Power the meter using the included four AA batteries or add an optional universal power adapter to save battery life when using the meter the lab. Utilize the durable meter armor with electrode holders, adjustable hand strap and built-in stand for on the go portability and use the field carrying case to store all required testing equipment in one easy to transport package.

The meter's informative, easy to read graphic display with backlight and onscreen calibration and setup instructions allow for intuitive, user-friendly operation with minimum training. A comprehensive keypad with menu-specific function keys and useful shortcut keys facilitates fast and efficient meter navigation and control. The multilanguage user interface allows customization of the meter in a variety of local languages with new languages available through software updates.

Measurements can be taken quickly and reliably with the onscreen reading stability indicator and selectable read modes – Auto-Read, timed or continuous with hold function. The data log collects up to 5000 measurement sets with time and date stamp and the non-volatile meter memory preserves all data, even with the loss of power. Use Thermo Scientific™ Orion™ Star Com™ software to facilitate data transfer from the meter to a computer via USB or RS232, export data to an Excel spreadsheet or comma separated value file (.csv) and print data to a network or local printer.

Meet your exact measurement needs by selecting a single, dual or multi-parameter meter from the seven available models of Orion Star A320 series portable meters.

Orion Star A321 pH Portable Meter

Measure pH, mV, relative mV or ORP with temperature

Orion Star A322 Conductivity Meter

Measure conductivity, TDS, salinity or resistivity with temperature

Orion Star A323 RDO/DO Meter

Measure dissolved oxygen as % saturation or concentration with temperature using either RDO® optical or polarographic DO sensors

Orion Star A324 pH/ISE Meter

Measure ion concentration using an ion selective electrode (ISE), pH, mV, relative mV or ORP with temperature

Orion Star A325 pH/Conductivity Meter

Measure pH, mV, relative mV or ORP with temperature on channel one and measure conductivity, TDS, salinity or resistivity with temperature on channel two

Orion Star A326 pH/RDO/DO Meter

Measure pH, mV, relative mV or ORP with temperature on channel one and measure dissolved oxygen as % saturation or concentration with temperature on channel two

Orion Star A329 pH/ISE/Conductivity/RDO/DO Meter

Measure pH, ion concentration, mV, relative mV or ORP with temperature on channel one; measure conductivity, TDS, salinity or resistivity with temperature on channel two; and measure dissolved oxygen as % saturation or concentration with temperature on channel three

Packing List

Orion Star A320 series portable meters include the following items:

- 4 AA batteries (installed)
- Literature CD with printed quick start guide
- Computer interface cable
- Meter test certificate

Orion Star A320 series portable meter kits also include the portable meter armor and field case.

Each Orion Star A320 series meter is fully tested and certified by Thermo Fisher Scientific and a certificate of calibration is included with each meter. For specific meter and kit contents, refer to the [Ordering Information](#) section.

Visit our website at www.thermoscientific.com/OrionMeters to download the complimentary Orion Star Com data transfer computer software and Star A200/A300 series USB driver.

Intended Use

Please read this reference guide thoroughly. Any use outside of these instructions may invalidate the meter warranty and cause permanent damage to the meter.

2

CHAPTER 2 Meter Basics

Installing Batteries

Four AA batteries are included with Orion Star A320 series portable meters and are preinstalled in the meter battery compartment. Use the following procedure to replace batteries as needed.

1. Select four new AA alkaline batteries.
2. Confirm that the meter is powered off.
3. Turn the meter over, with the meter display facing down, on a clean dry surface.
4. Loosen the two screws holding the battery cover in place and gently pull up the battery cover to release it from the meter.
5. Remove the old batteries from the battery compartment.
6. Install the new batteries in the battery compartment, orientating the batteries as shown in the battery compartment housing.
7. Replace the battery compartment cover and tighten the two screws to secure the battery cover with the meter.
8. Turn the meter over, with the meter display facing up, and power on the meter.

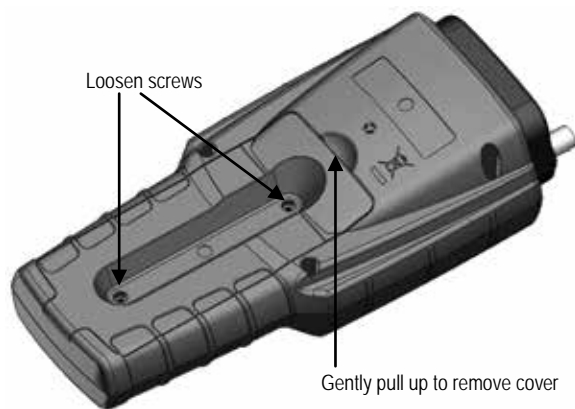

Using the Universal Power Adapter (Optional Power Source)

A universal power adapter (Catalog Number 1010003) with US, EU, UK and China plug plates can be purchased separately and used with the Orion Star A320 series portable meters. To save battery life, the meter will always obtain power from the universal power adapter when it is connected with the meter and a power outlet, even when batteries are installed in the meter. This universal power adapter is specifically for use with Star A320 series portable meters. Use of other power adapters can damage the meter and void the warranty.

1. Select the appropriate plug plate for the power outlet that will be used.
2. Remove the clear plastic cover from the groove on the back of the power adapter.
3. Slide the appropriate plug plate into the groove on the back of the power adapter.

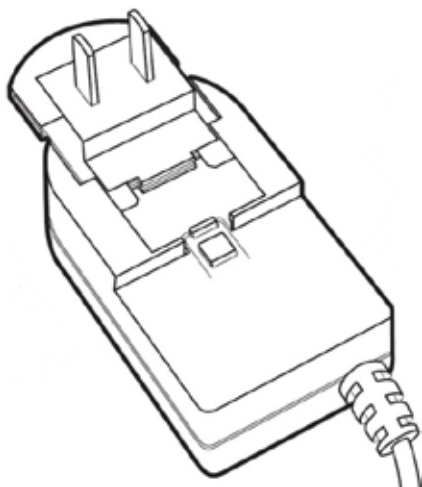

4. Connect the assembled power adapter to a power outlet and the meter input labeled Power. A surge protector or uninterruptible power supply (UPS) is also recommended.

Portable Meter Accessories

Orion Star A320 series portable meter kits include the portable meter armor with electrode holders, adjustable hand strap and built-in stand and the field carrying case. These portable meter accessories can also be purchased separately using the following catalog numbers.

Catalog Number	Description
STARA-AR	Orion Star A series portable meter armor with pH electrode holder, conductivity and DO sensor holder, adjustable hand-strap and built-in stand
STARA-ESPH	Orion Star A series pH electrode holder for portable meter armor
810017	Orion pH electrode sleeve for use with pH electrode holder
STARA-ESCD	Orion Star A series conductivity and DO sensor holder for portable meter armor
STARA-CS	Orion Star A series portable meter hard-sided field case

Orion Star A Series Portable Meter Armor

Insert the Orion Star A320 series portable meter into the top of the portable meter armor. The holders for a pH electrode and conductivity/DO sensors can be attached to either side of the meter armor. Adjust the hand strap as needed to your desired fit or use the strap with built-in stand to support the meter on a level surface.



pH Electrode Holder

Use the pH electrode holder with the pH electrode sleeve, Catalog Number 810017



Conductivity and Dissolved Oxygen Sensor Holder

Hold a 12mm or 15mm diameter conductivity sensor and a dissolved oxygen sensor in its calibration sleeve



Orion Star A Series Portable Meter Field Case

The hard-sided portable meter field case is designed to hold the Orion Star A320 series portable meter (with or without electrodes connected), electrodes and sensors, calibration and maintenance solutions, extra batteries and additional accessories all in one convenient location for easy portability in the field. The door can be easily detached for easier cable wrapping and then reattached to provide additional protection for the electrodes.



Meter Connections

The following diagram depicts all the possible meter connections available on the Orion Star A320 series portable meters. Some Orion Star A320 series portable meters will have fewer connections, depending on the meter's measurement capabilities.

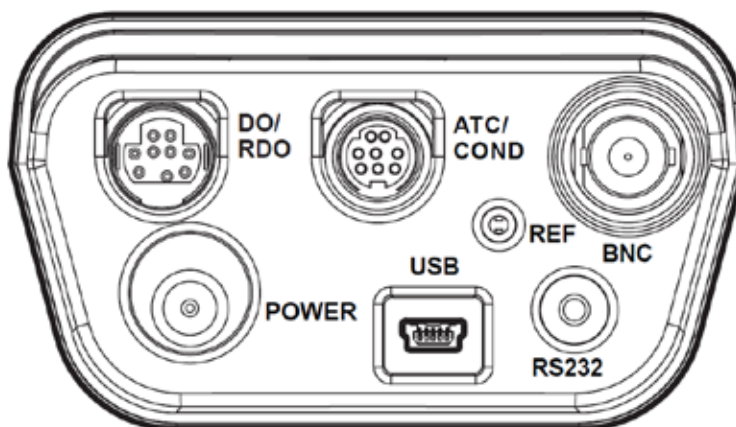

Connector	Function	Applicable Meter Models
Power	Connect the universal power adapter (catalog number 1010003) to power the meter	All Star A320 series meters
USB	Connect the USB cable for bi-directional data transfer and communication via USB to a printer or computer	All Star A320 series meters
RS232	Connect the RS232 cable for bi-directional data transfer and communication via RS232 to a printer or computer	All Star A320 series meters
BNC	Connect a pH electrode, ORP/redox electrode or ion selective electrode (ISE) with BNC connector	Star A321, Star A324, Star A325, Star A326 and Star A329 meters
Ref.	Connect a half-cell reference electrode with standard 2.5 mm pin-tip connector	Star A321, Star A324, Star A325, Star A326 and Star A329 meters
ATC/CON	Connect an ATC temperature probe with 8 pin MiniDIN connector	Star A321, Star A324 and Star A326 meters
	Connect a conductivity sensor or ATC temperature probe with 8 pin MiniDIN connector	Star A322, Star A325 and Star A329 meters
DO/RDO	Connect a dissolved oxygen sensor (either RDO optical or polarographic) with 9 pin MiniDIN connector	Star A323, Star A326 and Star A329 meters

Orion Star A320 series portable meters are compatible with the same electrodes and sensors used with Thermo Scientific™ Orion™ Versa Star™ meters and legacy Thermo Scientific™ Orion Star™ and Star Plus meters. This includes the Thermo Scientific™ Orion™ ROSS Ultra™ Triode™ pH/ATC electrodes, Thermo Scientific™ Orion™ ROSS™ pH electrodes and Thermo Scientific™ Orion™ DuraProbe™ conductivity sensors.

Orion Star A321 pH Meter Connections

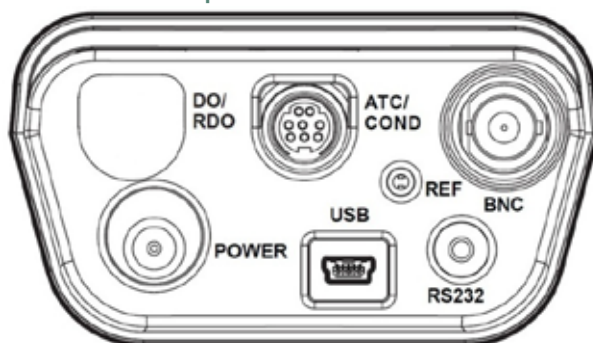

Orion Star A322 Conductivity Meter Connections

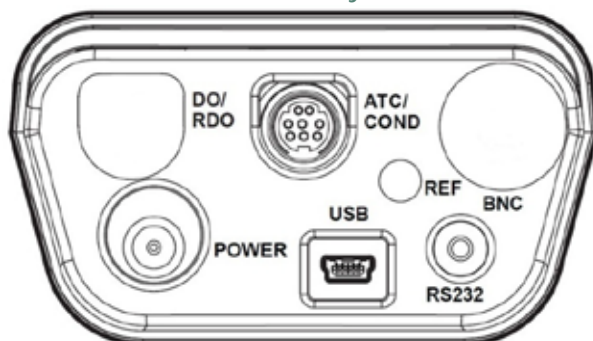

Orion Star A323 RDO/DO Meter Connections

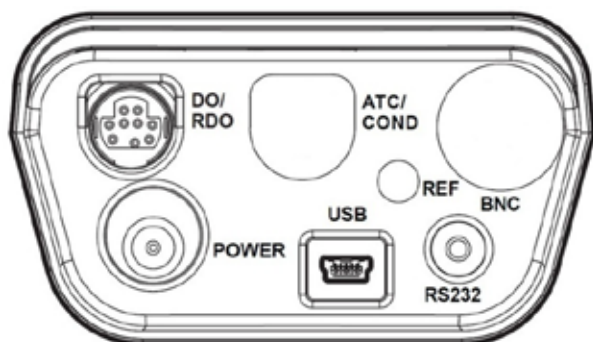

Orion Star A324 pH/ISE Meter Connections

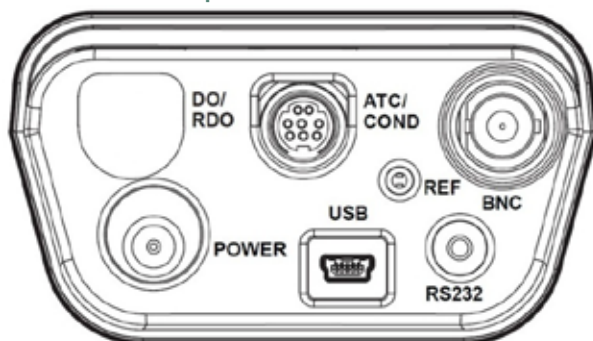

Orion Star A325 pH/Conductivity Meter Connections

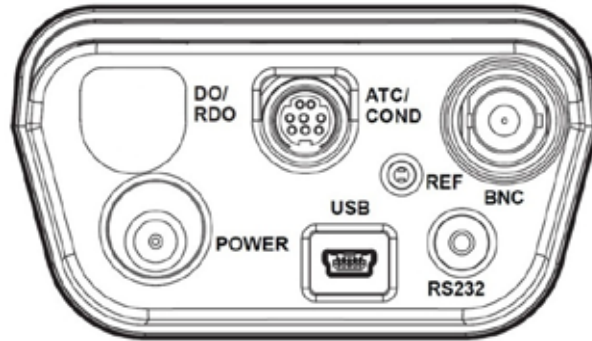

Orion Star A326 pH/RDO/DO Meter Connections

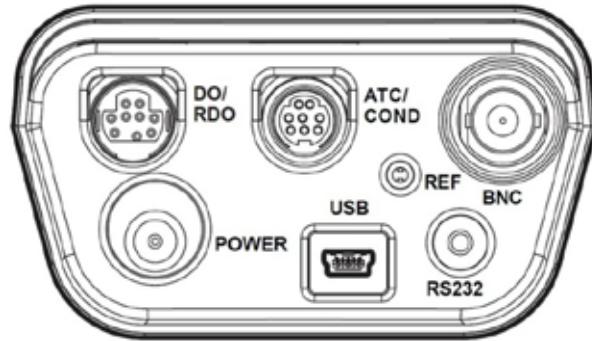



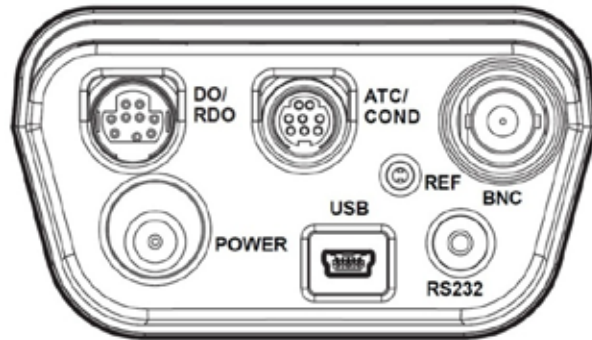

Orion Star A329 pH/ISE/Conductivity/RDO/DO Meter Connections





Meter Keypad

Orion Star A320 series portable meter keypads includes menu-specific function keys that update on the display for efficient meter operation and shortcut keys for easy navigation.



Key Icon and Name	Function
 f1, f2, f3	Press the f1 , f2 and f3 function keys to perform the action shown above each key on the display.
 power	Press the power key to turn on the meter. Press and hold the power key for about three seconds to turn off the meter. When the meter is powered on, press and release the power key to switch the display backlight on and off.
 measure (esc)	Press the measure (esc) key in the Auto-Read measurement mode to start a new measurement. Press the measure (esc) key to escape the current mode or menu and return to the measurement mode.
 setup / up arrow (P)	Press the setup key to enter the setup menu from the measurement mode. Press the up arrow (P) key to scroll up through a list of items.
 mode / right arrow (U)	Press the mode key to change the measurement mode of the displayed channel. Press the right arrow (U) key to scroll right through a list of items.

Key Icon and Name	Function
 log/print / down arrow (c)	Press the log/print key to manually log and/or print a measurement, depending on the selected measurement mode and export settings. Press the down arrow (c) key to scroll down through a list of items.
 Hold / left arrow (t)	In the continuous measurement mode, press the hold key to lock (freeze) the current displayed measurement and press the hold key again to release (unfreeze) the measurement. Press the left arrow (t) key to scroll left through a list of items.

Function Keys

The following image shows the **f1**, **f2** and **f3** keys with their corresponding actions above each function key on the meter display. Pressing the **f1 (cal)** key will prompt the meter to enter the calibration mode. Pressing the **f2 (sample ID)** key will prompt the meter to enter the sample ID setup mode. Pressing the **f3 (setup)** key will prompt the meter to enter the main setup menu.



Meter Display

Measurement Display Examples

The following displays are examples only. Actual meter displays will vary based on the selected meter setup parameters, active calibration data, etc.

Orion Star A321 pH Measurement Display



The image shows the Orion Star A321 pH measurement display. It features a color LCD screen with various data points and navigation buttons. The main display shows a temperature of 25.1 °C ATC and a pH value of 7.00. Other information includes the date and time (12/24/11 15:21), method (M1 100), and calibration points (4.01, 7.00). The screen also displays '0.0 mV' corresponding to the main measurement. Navigation buttons for 'cal', 'sample ID', and 'setup' are visible at the bottom.

- Temperature measurement and source → 25.1 °C ATC
- Main measurement mode → pH
- Main measurement value → 7.00
- Calibration points from most recent active calibration → Buffers 4.01 7.00
- Date and time → 12 / 24 / 11 15:21
- Method → M1 100
- Main measurement units → pH
- mV corresponding to main measurement → 0.0 mV

Orion Star A322 Conductivity Meter Display



The image shows the Orion Star A322 conductivity meter display. The screen displays a temperature of 24.7 °C ATC and a conductivity value of 1444 µS/cm. It also shows the date and time (01/24/12 15:03), method (M200), and temperature compensation setting (Tct-Li). Calibration points (Std: M10) are visible. Navigation buttons for 'cal', 'sample ID', and 'setup' are at the bottom.

- Temperature measurement and source → 24.7 °C ATC
- Main measurement mode → Cond
- Main measurement value → 1444
- Calibration points from most recent active calibration → Std: M10
- Date and time → 01 / 24 / 12 15:03
- Method → M200
- Main measurement units → µS/cm
- Temperature compensation setting → Tct-Li

Orion Star A323 RDO/DO Meter Display



The image shows the Orion Star A323 RDO/DO meter display. The screen displays a temperature of 24.8 °C ATC and an RDO value of 97.8. It also shows the date and time (01/24/12 12:01), method (M300), and salinity value (Salt: 0.0). Barometric pressure (Auto Baro Press: 740) is also displayed. Navigation buttons for 'cal', 'sample ID', and 'setup' are at the bottom.

- Temperature measurement and source → 24.8 °C ATC
- Main measurement mode → RDO
- Main measurement value → 97.8
- Barometric pressure → Auto Baro Press: 740
- Date and time → 01 / 24 / 12 12:01
- Method → M300
- Main measurement units → Xsat
- Salinity value → Salt: 0.0

Orion Star A324 pH/ISE Meter Display

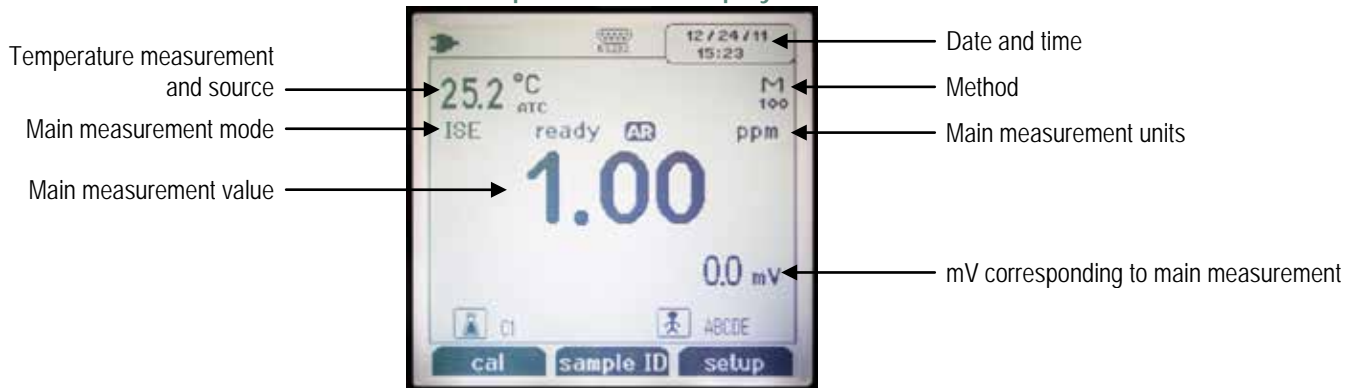

Orion Star A325 pH/Conductivity Meter Display

Display each channel separately or both channels simultaneously using the f3 (channel) key.

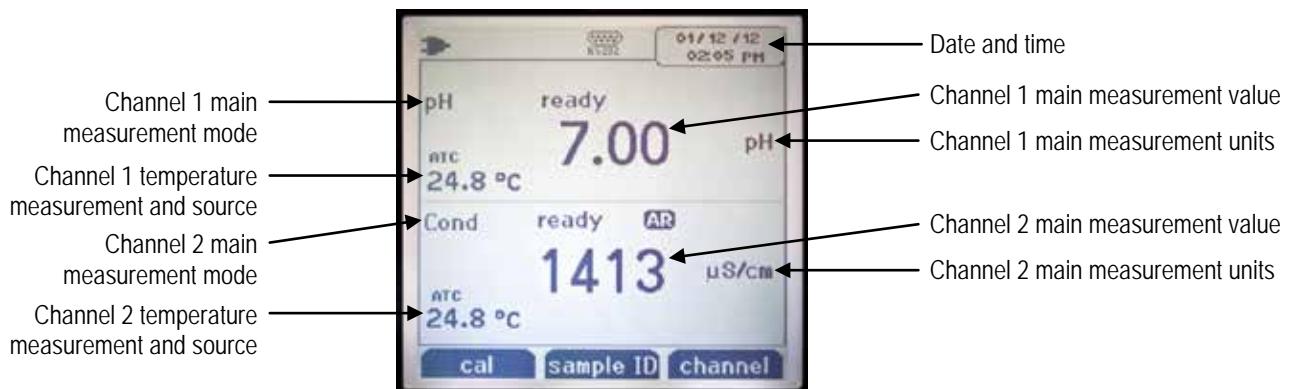

Orion Star A326 pH/RDO/DO Meter Display

Display each channel separately or both channels simultaneously using the f3 (channel) key.

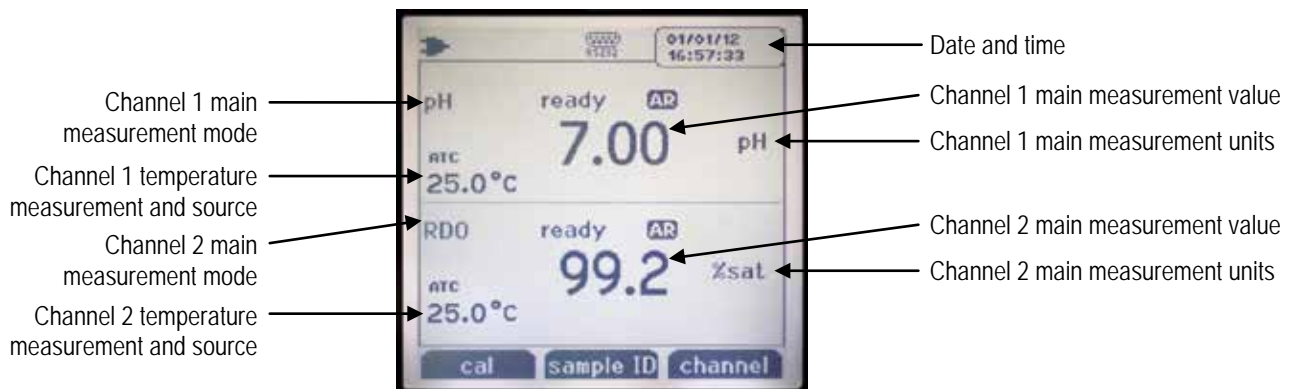

Orion Star A329 pH/ISE/Conductivity/RDO/DO Meter Display

Display each channel separately, two channels simultaneously or all three channels simultaneously using the **f3 (channel)** key.

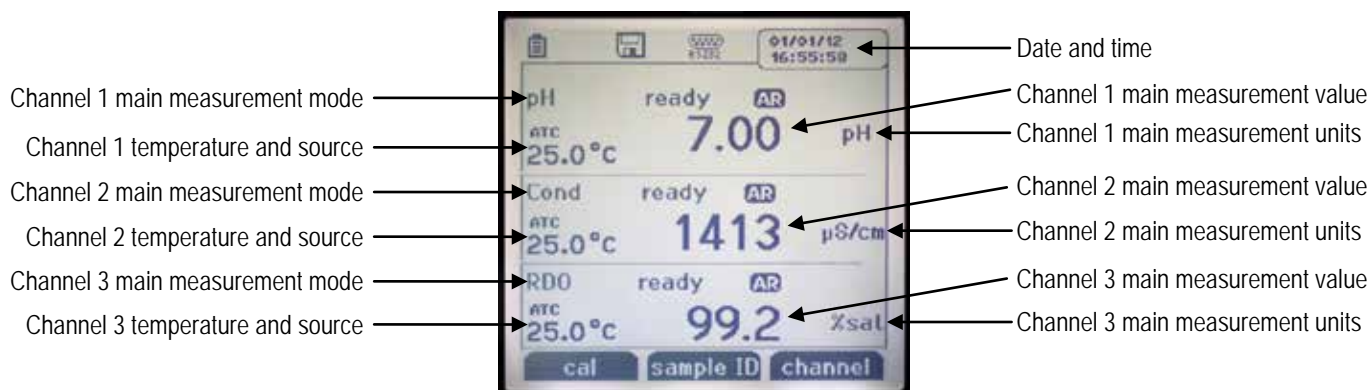



Measurement Display Icons

Display Icon	Description
	Shown when the meter is running on AC power
	Shown when the meter is running on battery power
	Indicates when data is exported to a computer or printer
	Indicates when a measurement is recorded in the data log
	Shown when an alarm is set and the alarm is triggered
	Indicates the RS232 port is selected for printer or computer interfacing
	Indicates the USB port is selected for printer or computer interfacing
	Displays the active temperature measurement and indicates the source as an ATC temperature sensor (ATC) or manually entered temperature value (MAN)
	Shown when the hold key is pressed and displayed measurements are frozen, press the hold key a second time to release the hold function
	Indicates a calibration has been successfully completed, flashes when the calibration alarm is set and the alarm is triggered
	Indicates the pH electrode condition as good (two bars), fair (one bar) or bad (slash through it), based on the last saved calibration and electrode stability
	Indicates the active measurement method number, M100 and M200 are the default methods and indicate a password-protected method is not in use
	Stability indicator will flash stabilizing while the measurement is changing and show ready when the measurement is stable
	When the read type is set to Auto-Read, the icon will flash while the reading is stabilizing and remain solid when the reading is stable and locked on the display
	Indicates the sample ID function is active, the operator assigned number is shown to the right of the icon
	Indicates the user ID function is active, the operator assigned name is shown to the right of the icon

pH Electrode Condition Icon

Orion Star A321 pH meters, Orion Star A324 pH/ISE meters, Orion Star A325 pH/conductivity meters, Orion Star A326 pH/RDO/DO meters and Orion Star A329 pH/ISE/conductivity/RDO/DO meters include a pH electrode condition icon. In the measurement mode, the pH electrode condition icon indicates the performance of the pH electrode, based on the last saved calibration and electrode measurement stability.

Icon	pH Electrode Status
	Electrode condition is good. The electrode slope is in the range of 95.1% to 104.9%.
	Electrode condition is fair. The electrode slope is 85.1% to 95% or 105% to 114.9%.
	Electrode condition is bad. The electrode slope is 85% or lower or 115% or higher. Consult the pH electrode manual for instructions on how to clean, condition and troubleshoot the electrode.

Note: This is a general indicator of overall electrode status – always refer to the pH electrode user manual for specific information on the recommended slope range for each pH electrode.

Meter Models and Measurement Capabilities

The table below shows the available models of Orion Star A320 series portable meters and their available measurement modes. All measurements include temperature.

Meter Model	Channel 1 Measurement Modes	Channel 2 Measurement Modes	Channel 3 Measurement Modes	Temperature Modes
Star A321 pH Meter	pH mV RmV ORP	n/a	n/a	Automatic Manual
Star A322 Conductivity Meter	Conductivity TDS Salinity Resistivity	n/a	n/a	Automatic Manual
Star A323 RDO/DO Meter	Dissolved Oxygen as % Saturation or mg/L	n/a	n/a	Automatic
Star A324 pH/ISE Meter	pH mV RmV ORP ISE	n/a	n/a	Automatic Manual
Star A325 pH/Conductivity Meter	pH mV RmV ORP	Conductivity TDS Salinity Resistivity	n/a	Automatic Manual
Star A326 pH/RDO/DO Meter	pH mV RmV ORP	Dissolved Oxygen as % Saturation or mg/L	n/a	Automatic Manual (channel 1 only)
Star A329 pH/ISE/Conductivity/RDO/DO Meter	pH mV RmV ORP ISE	Conductivity TDS Salinity Resistivity	Dissolved Oxygen as % Saturation or mg/L	Automatic Manual (channel 1 and 2 only)

Meter Maintenance

- For routine meter maintenance, dust and wipe with a damp cloth. If necessary, warm water or mild water-based detergent can be used.
- Meter maintenance can be performed on a daily, weekly or monthly basis, as required by the operating environment.
- Remove any spilled substances immediately from the meter or module using the proper cleaning procedure for that spill type.

3

CHAPTER 3 Meter Setup Menus

Main Setup Menu





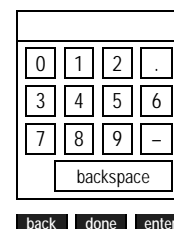

The main setup menu of the Orion Star A320 series meters contains menus for measurement settings, instrument settings, calibration and data logs and meter diagnostics in one location.

General Setup Menu Navigation

1. In the measurement mode, press the **setup** key to access the main setup menu.
2. Press the **p**, **q**, **t** or **u** key to scroll through and highlight a setup menu icon and press the **f3 (select)** key to access the submenus for the selected menu.
3. Press the **p** or **q** key to scroll and highlight a submenu option and press the **f3 (select)** key to access the parameters for the selected submenu.
4. Perform the appropriate actions to set the parameters and settings in the selected menu.
 - a. To select a value from a list of options, press the **p** or **q** key to highlight the desired value and then press the **f3 (select)** key to set the value.
 - b. To enter a numeric value, use the popup number entry screen.
 - i. Press the **f3 (edit)** key to open the number entry screen.
 - ii. Press the **p**, **q**, **t** or **u** key to highlight a number, decimal point or negative sign and then press the **f3 (enter)** key to select the highlighted item. Repeat until the desired value is shown at the top of the screen.
 - iii. Press the **f2 (done)** key to save the value and exit the number entry screen.
5. Press the **f1 (back)** key to navigate out of a menu and press the **measure (esc)** key to return to the measurement mode at any time.



Main Setup Menu Icons and Descriptions

Icon	Description	Applicable Meter Models
 Channel	Use the pH Channel menu to customize measurement, calibration and alarm settings for pH, mV, RmV (relative mV), ORP and temperature	Star A321 pH meter Star A325 pH/conductivity meter Star A326 pH/RDO/DO meter
 Channel	Use the pH/ISE Channel menu to customize measurement, calibration and alarm settings for pH, mV, RmV (relative mV), ORP, ISE and temperature	Star A324 pH/ISE meter Star A329 pH/ISE/conductivity/RDO/DO meter
 Channel	Use the COND Channel menu to customize measurement, calibration and alarm settings for conductivity, salinity, TDS, resistivity and temperature	Star A322 conductivity meter Star A325 pH/conductivity meter Star A329 pH/ISE/conductivity/RDO/DO meter
 Channel	Use the DO/RDO Channel menu to customize measurement, calibration and alarm settings for dissolved oxygen and temperature	Star A323 RDO/DO meter Star A326 pH/RDO/DO meter Star A329 pH/ISE/conductivity/RDO/DO meter
 Settings	Use the Instrument Settings menu to update meter settings for data transfer, data log, date and time, language, sounds, stirrer speed, display contrast, auto-shutoff, user ID and sample ID	All Star A320 series meters
 View Log	Access the View Log menu to view, export or clear saved data in the data log and view or print the ten most recent calibrations per channel in the calibration log	All Star A320 series meters
 Diagnostics	Access the Diagnostics menu to initiate a meter reset, perform a meter self test, test electrode stability or view the meter serial number and software revision	All Star A320 series meters

Example Main Setup Menu Displays



Star A321 pH Meter Setup Menu

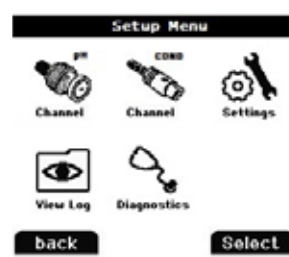

Star A325 pH/Conductivity Meter Setup Menu

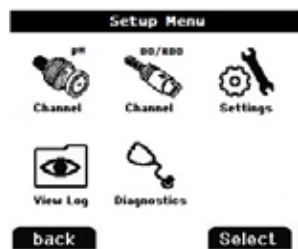

Orion Star A326 pH/RDO/DO Meter Setup Menu

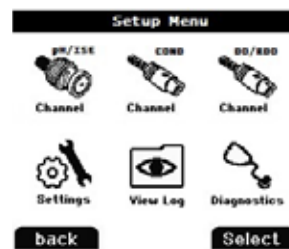

Star A329 pH/ISE/Conductivity/RDO/DO Meter Setup Menu

Main Setup Menu Flow Chart

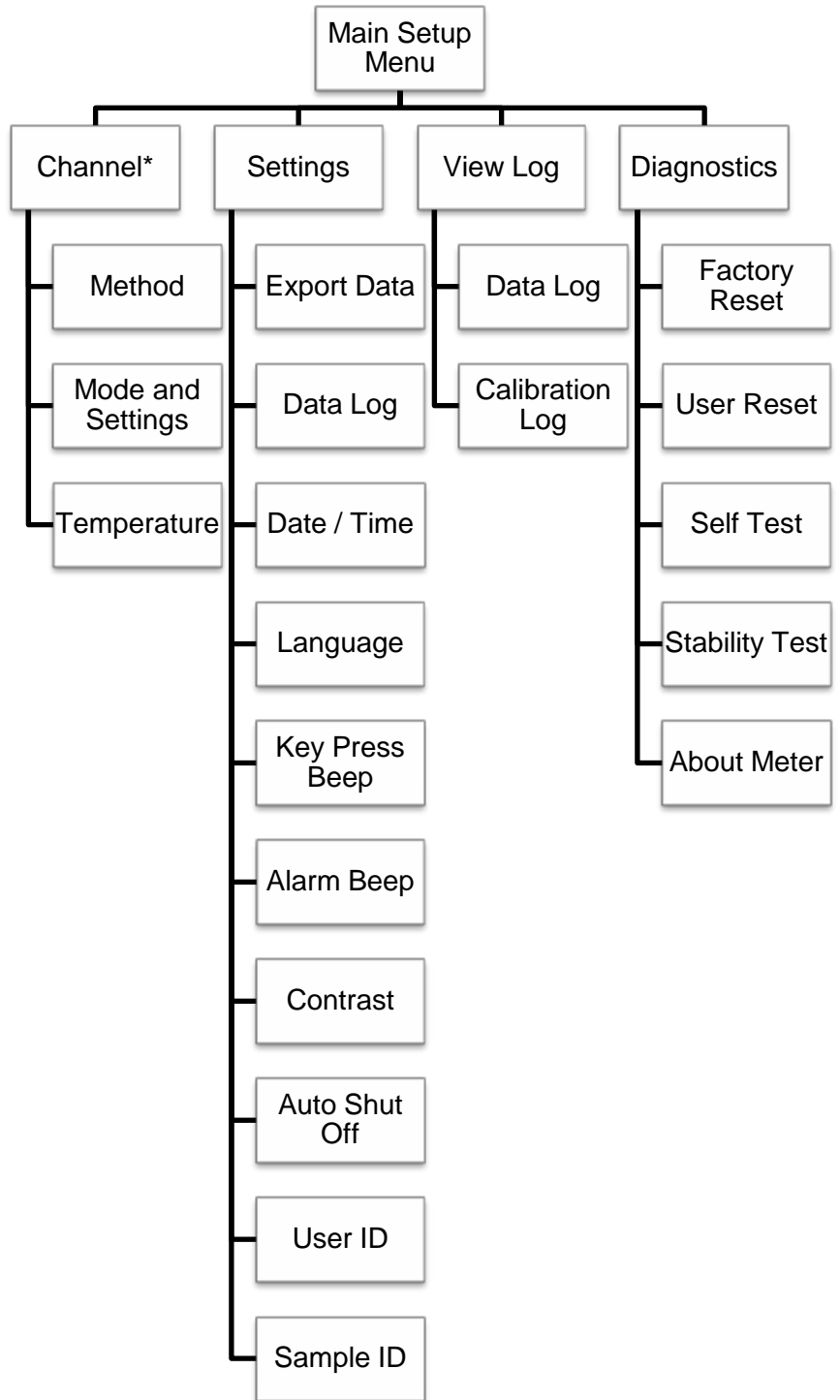

** Refer to next figure for a detailed list of the measurement, calibration and alarm settings within each channel-specific Mode and Settings menu.*

Channel-specific Mode and Settings Menu Flow Chart

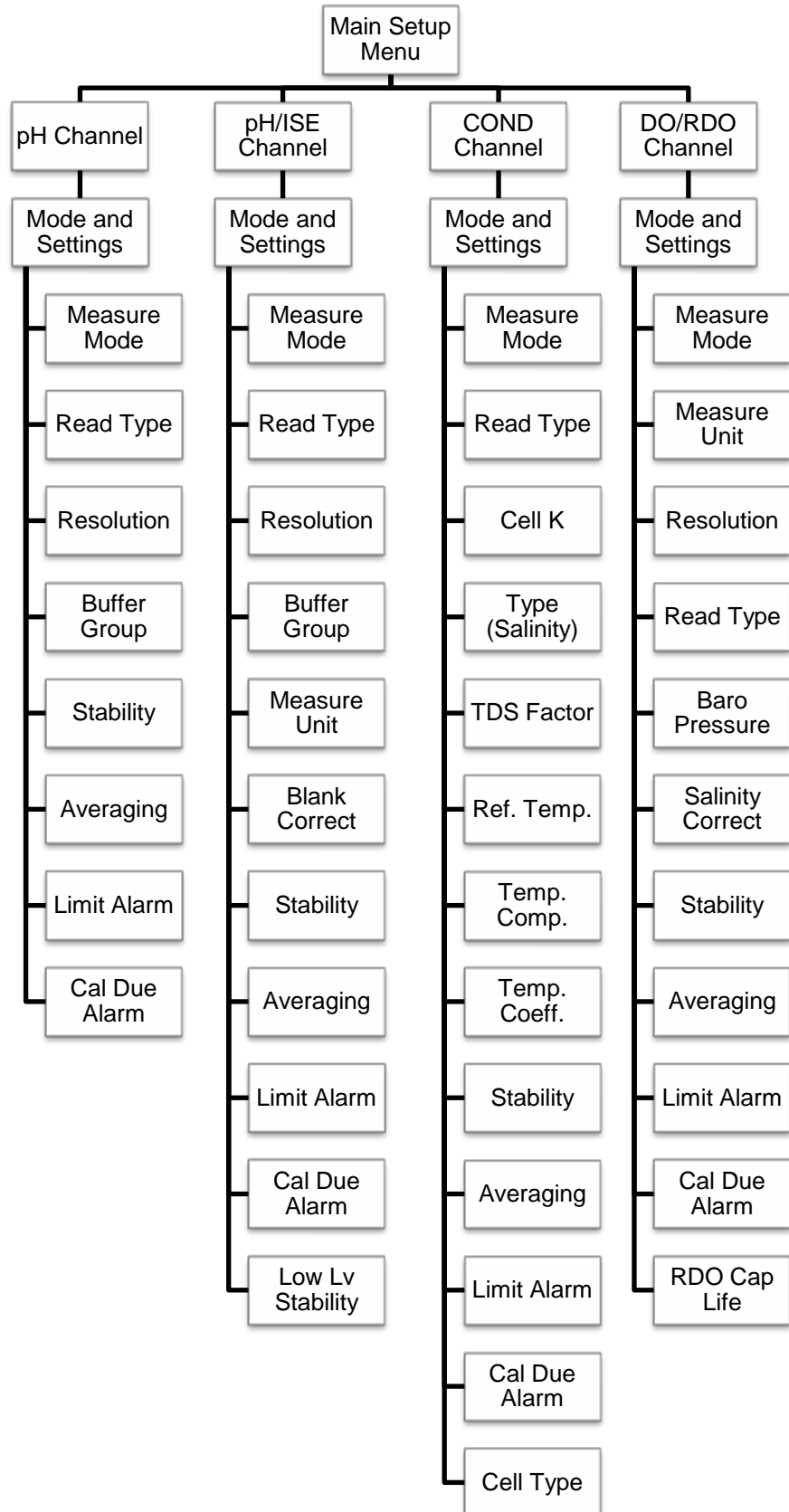

Channel-Specific Method, Mode and Temperature Menus

Within the pH Channel, pH/ISE Channel, COND Channel and DO/RDO Channel menus are Method, Mode and Settings and Temperature submenus, which can be used to customize the measurement, calibration and alarm settings for each channel. The channel menus displayed by each meter will depend on the meter model and its measuring capabilities.

Meter Model	Available Channel-specific Menus
Orion Star A321 pH meter	pH Channel
Orion Star A322 conductivity meter	COND Channel
Orion Star A323 RDO/DO meter	RDO/DO Channel
Orion Star A324 pH/ISE meter	pH/ISE Channel
Orion Star A325 pH/conductivity meter	pH Channel
	COND Channel
Orion Star A326 meters pH/RDO/DO meter	pH Channel
	RDO/DO Channel
Orion Star A329 pH/ISE/conductivity/RDO/DO meter	pH/ISE Channel
	COND Channel
	RDO/DO Channel

- **Method** – Use the Method setup menu to create, load, copy, edit or delete password protected methods.
- **Mode and Settings** – Select the Mode and Settings menu to review and update the measurement, calibration and alarm settings for the selected channel.
- **Temperature** – Use the Temperature menu to manually enter a sample temperature value, set the temperature units as °C or °F, perform a temperature calibration on an ATC probe or conductivity / dissolved oxygen sensor with built-in temperature and set temperature input source for meters with dual temperature sources.

Method Menu

Save up to ten channel-specific methods in the Method menu for fast and easy recollection of custom channel-specific measurement, calibration and alarm settings.

The default method (M100, M200 or M300) is updated whenever the channel-specific measurement, calibration and alarm settings are changed in the Mode and Settings menu and the default method is not password protected.

The custom methods (M101-M110, M201-M210 or M301-M310) can be protected using a three to eight digit password. When a protected method is created, loaded and active in the measurement mode and a calibration is performed, that calibration will be saved to the method so every time the method is loaded, the corresponding calibration will also be loaded.

Protected methods are helpful when using two or more electrodes on one channel. For example, a pH electrode and an ion selective electrode (ISE) used on the same BNC input of the Star A324 pH/ISE meter or a low range conductivity sensor and standard range conductivity sensor used on the same 8 pin MiniDIN input of the Star A322 conductivity meter.

Creating a New Method using the Current Meter Settings

1. In the measurement mode, press the **setup** key.
2. Press the **p**, **q**, **t** or **u** key to highlight pH Channel, pH/ISE Channel, COND Channel or DO/RDO Channel and press the **f3 (select)** key.
3. Press the **p** or **q** key to highlight Method and press the **f3 (select)** key to access the methods list.
4. Press the **p** or **q** key to highlight Current Settings and press the **f3 (save)** key.
5. Press the **p** or **q** key to highlight an open method (M101-M110, M201-M210 or M301-M310) to save the current channel-specific settings to and press the **f2 (accept)** key.
 - a. Open methods have no date, time or mode shown in the methods list.
6. Use the popup number entry screen to create a method-specific password (3 to 8 digits).
 - a. Press the **f3 (edit)** key to access the number entry screen.
 - b. Press the **p**, **q**, **t** or **u** key to highlight a number, press the **f3 (enter)** key to select the number and repeat until the desired password is shown at the top of the number entry screen.
 - c. Press the **f2 (done)** key to accept the password and exit the number entry screen.
7. Press the **f2 (accept)** key to save the entered password.
8. The meter will return to the methods list and the selected method number will have the date, time and mode shown in the methods list.

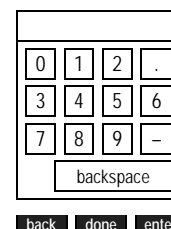

Loading a Method

Use the load function to activate a protected method for use in the measurement mode. If no protected method has been created, the open method is active. A password is not required to load a protected method.

1. In the measurement mode, press the **setup** key.
2. Press the **p**, **q**, **t** or **u** key to highlight pH Channel, pH/ISE Channel, COND Channel or DO/RDO Channel and press the **f3 (select)** key.
3. Press the **p** or **q** key to highlight Method and press the **f3 (select)** key to access the methods list.
4. Press the **p** or **q** key to highlight a protected method to be loaded in the measurement mode and press the **f2 (load)** key.
 - a. Protected methods have the date, time and mode shown in the methods list.
5. The meter will automatically proceed to the measurement mode.

Copying a Method

Use the copy function to save the channel-specific measurement, calibration and alarm settings of an existing method to a new method, so the original method settings are preserved and the new method settings can be modified. When using the copy function to create a new method, a new password must be created for the new method to be saved.

1. In the measurement mode, press the **setup** key.
2. Press the **p**, **q**, **t** or **u** key to highlight pH Channel, pH/ISE Channel, COND Channel or DO/RDO Channel and press the **f3 (select)** key.
3. Press the **p** or **q** key to highlight Method and press the **f3 (select)** key to access the methods list.
4. Press the **p** or **q** key to highlight a protected method to be copied to an open protected method and press the **f3 (options)** key.
 - a. Protected methods have the date, time and mode shown in the methods list.
5. Use the popup number entry screen to enter the specific password for the selected method.
 - a. Press the **f3 (edit)** key to access the number entry screen.
 - b. Press the **p**, **q**, **t** or **u** key to highlight a number, press the **f3 (enter)** key to select the number and repeat until the correct password is shown at the top of the screen.
 - c. Press the **f2 (done)** key to accept the password and exit the number entry screen.
6. Press the **f2 (accept)** key to submit the password for the selected method.
7. Press the **p** or **q** key to highlight Copy and press the **f2 (accept)** key.
8. Press the **p** or **q** key to highlight an open method and press the **f2 (accept)** key.
 - a. Open methods have no date, time or mode shown in the methods list.
9. Use the popup number entry screen to create a password for the new method.

- a. Press the **f3 (edit)** key to access the number entry screen.
 - b. Press the **p**, **q**, **t** or **u** key to highlight a number, press the **f3 (enter)** key to select the number and repeat until the desired password is shown at the top of the screen.
 - c. Press the **f2 (done)** key to accept the password and exit the number entry screen.
10. Press the **f2 (accept)** key to submit the new password for the new method.
 11. The meter will return to the methods list and the new method number will have the date, time and mode shown in the methods list.

Editing or Deleting a Method

Use the edit function to modify the channel-specific measurement, calibration and alarm settings of an existing protected method. Use the delete function to convert an existing protected method to an open method.

1. In the measurement mode, press the **setup** key.
2. Press the **p**, **q**, **t** or **u** key to highlight pH Channel, pH/ISE Channel, COND Channel or DO/RDO Channel and press the **f3 (select)** key.
3. Press the **p** or **q** key to highlight Method and press the **f3 (select)** key to access the methods list.
4. Press the **p** or **q** key to highlight a protected method and press the **f3 (options)** key.
 - a. Protected methods have the date, time and mode shown in the methods list.
5. Use the popup number entry screen to enter the specific password for the selected method.
 - a. Press the **f3 (edit)** key to access the number entry screen.
 - b. Press the **p**, **q**, **t** or **u** key to highlight a number, press the **f3 (enter)** key to select the number and repeat until the correct password is shown at the top of the screen.
 - c. Press the **f2 (done)** key to accept the password and exit the number entry screen.
6. Press the **f2 (accept)** key to submit the password for the selected method.
7. Press the **p** or **q** key to highlight Edit or Delete and press the **f2 (accept)** key.
 - a. If Edit is selected:
 - i. Perform the appropriate actions to set the channel-specific measurement, calibration and alarm settings within the selected method.
 - ii. Once the required settings have been edited, press the **f1 (back)** key to return to the methods list.
 - b. If Delete is selected:
 - i. Press the **f2 (yes)** key to confirm the deletion of the selected method.
 - ii. The method will be deleted and the meter will automatically proceed to the measurement mode.

Mode and Settings Menu

General Mode and Settings Options

Read Types

The read type determines how the meter displays, logs and exports measurements. Ensure the appropriate data export and data log settings are enabled in the Instrument Settings menu before logging or exporting measurements.

- **Auto-Read:**
 - Press the **measure (esc)** key to start a measurement. The **AR** icon blinks as the changing value stabilizes. When stable, the **AR** icon stops blinking and the measurement is locked on the display until the **measure (esc)** key is pressed again.
 - When enabled, the stable measurement is automatically saved to the data log and exported to a printer or computer.
- **Continuous:**
 - Measurement values are continuously updated on the display and the **Stabilizing** or **Ready** icon indicates the measurement stability status.
 - When enabled, press the **log/print** key to save a measurement to the data log and export it to a printer or computer.
- **Timed:**
 - Measurement values are continuously updated on the display and the **Stabilizing** or **Ready** icon indicates the measurement stability status.
 - When enabled, measurements are saved to the data log and exported to a printer or computer at the selected time interval of 3 seconds (00:00:03) to 24 hours (24:00:00).

Stability Setting Information

The stability setting determines when a measurement is recognized as stable by the meter, using an algorithm that evaluates measurement fluctuations. When Smart Stability is selected, the measurement resolution is utilized in conjunction with the algorithm. Approximate mV per minute values, estimated with ideal measurement conditions, are shown below. Values are theoretical only and actual values will vary based on individual measurement conditions.

Smart Stability Setting	mV per Minute	Stability Setting	mV per Minute
0.1 resolution or 1 significant digit	7.6	Fast Stability	7.6
0.01 resolution or 2 significant digits	2.9	Medium Stability	2.9
0.001 resolution or 3 significant digits	1.0	Slow Stability	1.0

Averaging Setting

The averaging setting allows the operator to select Automatic Smart averaging for faster measurement stability or Off for no measurement averaging once the stability criteria is met.

Limit Alarm Setting

The limit alarm setting allows measurements to be evaluated using set high limit and/or low limit values. If a measurement goes above the high limit value or below the low limit value, the alarm is triggered. For example, when the high limit is set to 8.50 pH, the alarm will activate when a measurement of 8.51 pH or higher is read in the measurement mode. Turn on the alarm beep setting in the Instrument Settings menu to enable an audible beep when the alarm is triggered.

Calibration Due Alarm Setting

The calibration due alarm allows the operator to set a custom calibration interval in hours. If a calibration is not performed within the specified calibration interval, the alarm is triggered. Turn on the alarm beep setting in the Instrument Settings menu to enable an audible beep when the alarm is triggered.

Mode and Settings Menu for pH Channel

Use the Mode and Settings menu to customize settings for the pH channel of Orion Star A321 pH meters, Orion Star A325 pH/conductivity meters and Orion Star A326 pH/RDO/DO meters. Default meter settings are **bold**.

Parameter	Settings	Details
Measure Mode	<ul style="list-style-type: none"> • pH • mV • RmV • ORP 	Set the displayed measurement mode, the selected mode determines which additional settings are shown and the type of calibration the meter will perform
Read Type	<ul style="list-style-type: none"> • Auto • Continuous • Timed 00:00:03 	Set the read type to determine how the meter takes a measurement and when the measurement is sent to the data log and/or external device
Resolution (pH only)	1 Decimal Place 0.1 2 Decimal Places 0.01 3 Decimal Places 0.001	Set the resolution of the pH measurement value
Buffer Group (pH only)	<ul style="list-style-type: none"> • USA • DIN 	Set the buffer group for automatic buffer recognition during pH calibrations USA: pH 1.68, 4.01, 7.00, 10.01 and 12.46 buffers DIN: pH 1.68, 4.01, 6.86 and 9.18 buffers
Stability	<ul style="list-style-type: none"> • Smart Stability • Fast • Medium • Slow 	Set when a measurement is recognized as stable, Smart Stability compensates for measurement conditions and optimizes the meter response time
Averaging	<ul style="list-style-type: none"> • Off • Automatic Smart 	Set averaging for faster measurement stability, Automatic Smart compensates for measurement conditions and optimizes the meter response time
Limit Alarm	<ul style="list-style-type: none"> • Limit Alarm Off On • Alarm Settings High High/Low Low • High Limit • Low Limit 	Set the limit alarm off or on, when alarm is on – set the alarm setting as high, high/low or low and then enter the appropriate measurement limit values The limit alarm is triggered when the measurement goes above the high limit or below the low limit
Cal Due Alarm (pH, RmV and ORP only)	<ul style="list-style-type: none"> • Cal Due Alarm On Off • Cal Due Limit 12 Hrs 	Set the calibration due alarm off or on, when the cal due alarm is on – enter the calibration time interval in hours (1 to 9998 hours) The cal due alarm is triggered after the entered time has elapsed without a calibration being performed

Buffer Group Setting

Orion Star A321 pH meters, Orion Star A325 pH/conductivity meters and Orion Star A326 pH/RDO/DO meters are capable of automatically recognizing pH buffer values within the selected buffer set during a pH calibration. During the pH calibration, the meter uses the selected pH buffer set and the raw mV reading of the pH electrode in the buffer to recognize and display the buffer value at the measured temperature. The raw mV reading of the pH electrode in the buffer must be within one pH unit (approximately ± 59 mV) of the buffer's theoretical mV value for the meter to recognize the buffer.

USA Buffer Set		DIN Buffer Set	
pH Buffer	mV range	pH Buffer	mV range
1.68	+255 mV to +374 mV	1.68	+255 mV to +374 mV
4.01	+117 mV to +236 mV	4.01	+117 mV to +236 mV
7.00	-59 mV to +59 mV	6.86	-51 mV to +67 mV
10.01	-237 mV to -119 mV	9.18	-189 mV to -70 mV
12.46	-382 mV to -264 mV		

Testing a pH Electrode for Automatic Buffer Recognition

Use the following procedure to verify that the raw mV reading of the pH electrode is within one pH unit (± 59 mV) from the theoretical mV reading of the pH buffer, and therefore verify that the pH electrode in use is capable of performing automatic buffer recognition.

1. Prepare the pH electrode according to the electrode manual. Set the meter measurement mode to mV.
2. Rinse the pH electrode with distilled water, blot it dry with a lint-free tissue and place the pH electrode into a pH 4.01 buffer at approximately 25 °C.
3. Wait for the measurement to stabilize and record the mV value of the pH 4.01 buffer when the measurement is stable.
4. Remove the pH electrode from the pH 4.01 buffer.
5. Rinse the pH electrode with distilled water, blot it dry with a lint-free tissue and place the pH electrode into a pH 7.00 buffer at approximately 25 °C.
6. Wait for the measurement to stabilize and record the mV value of the pH 7.00 buffer when the measurement is stable.
7. The mV reading of the pH electrode in pH 4 buffer should be +117 to +236 mV and in pH 7 buffer should be -59 to +59 mV. If the mV readings are in the correct ranges, the pH electrode is capable of performing automatic buffer recognition. If the mV readings are not in the correct ranges, manually enter the pH buffer values during a pH calibration.

Mode and Settings Menu for pH/ISE Channel

Use the Mode and Settings menu to customize settings for the pH/ISE channel of Star A324 pH/ISE meters and Star A329 pH/ISE/Conductivity/RDO/DO meters. Default settings are **bold**.

Parameter	Settings	Details
Measure Mode	<ul style="list-style-type: none"> • pH • mV • RmV • ORP • ISE 	Set the displayed measurement mode, the selected mode determines which additional settings are shown and the type of calibration the meter will perform
Read Type	<ul style="list-style-type: none"> • Auto • Continuous • Timed 00:00:03 	Set the read type to determine how the meter takes a measurement and when the measurement is sent to the data log and/or external device
Resolution (pH only)	<ul style="list-style-type: none"> 1 Decimal Place 0.1 2 Decimal Places 0.01 3 Decimal Places 0.001 	Set the resolution of the pH measurement value
Buffer Group (pH only)	<ul style="list-style-type: none"> • USA • DIN 	Set the buffer group for automatic buffer recognition during pH calibrations USA: pH 1.68, 4.01, 7.00, 10.01 and 12.46 buffers DIN: pH 1.68, 4.01, 6.86 and 9.18 buffers
Resolution (ISE only)	<ul style="list-style-type: none"> 1 significant digit 2 significant digits 3 significant digits 	Set the resolution of the ion concentration (ISE) measurement value
Measure Unit (ISE only)	<ul style="list-style-type: none"> • ppm • M • mg/L • Percentage (%) • ppb • None 	Set the units displayed with the ion concentration (ISE) measurement value
Blank Correct (ISE only)	<ul style="list-style-type: none"> • Yes • No 	Set the automatic blank correction function off or on for ISE measurements, when the function is on – an algorithm is used to compensate for the non-linear response of the electrode in low level standards and samples for improved measurement stability
Stability	<ul style="list-style-type: none"> • Smart Stability • Fast • Medium • Slow 	Set when a measurement is recognized as stable, Smart Stability compensates for measurement conditions and optimizes the meter response time
Averaging	<ul style="list-style-type: none"> • Off • Automatic Smart 	Set averaging for faster measurement stability, Automatic Smart compensates for measurement conditions and optimizes the meter response time
Limit Alarm	<ul style="list-style-type: none"> • Limit Alarm Off On • Alarm Settings High High/Low Low • High Limit • Low Limit 	Set the limit alarm off or on, when alarm is on – set the alarm setting as high, high/low or low and then enter the appropriate measurement limit values The limit alarm is triggered when the measurement goes above the high limit or below the low limit
Cal Due Alarm (pH, RmV, ORP and ISE only)	<ul style="list-style-type: none"> • Cal Due Alarm On Off • Cal Due Limit 12 Hrs 	Set the calibration due alarm off or on, when the cal due alarm is on – enter the calibration time interval in hours (1 to 9998 hours) The cal due alarm is triggered after the entered time has elapsed without a calibration being performed
Low Lv Stability	<ul style="list-style-type: none"> • Off • On 	Set the low level stability function off or on for ISE calibrations, when the function is on – the minimum stabilization time is increased (~3-5 minutes) to improve accuracy in low level calibration standards

Buffer Group Setting

Orion Star A324 pH/ISE meters and Orion Star A329 pH/ISE/conductivity/RDO/DO meters are capable of automatically recognizing pH buffer values within the selected buffer set during a pH calibration. During the pH calibration, the meter uses the selected pH buffer set and the raw mV reading of the pH electrode in the buffer to recognize and display the buffer value at the measured temperature. The raw mV reading of the pH electrode in the buffer must be within one pH unit (approximately ± 59 mV) of the buffer's theoretical mV value for the meter to recognize the buffer.

USA Buffer Set		DIN Buffer Set	
pH Buffer	mV range	pH Buffer	mV range
1.68	+255 mV to +374 mV	1.68	+255 mV to +374 mV
4.01	+117 mV to +236 mV	4.01	+117 mV to +236 mV
7.00	-59 mV to +59 mV	6.86	-51 mV to +67 mV
10.01	-237 mV to -119 mV	9.18	-189 mV to -70 mV
12.46	-382 mV to -264 mV		

Testing a pH Electrode for Automatic Buffer Recognition

Use the following procedure to verify that the raw mV reading of the pH electrode is within one pH unit (± 59 mV) from the theoretical mV reading of the pH buffer, and therefore verify that the pH electrode in use is capable of performing automatic buffer recognition.

1. Prepare the pH electrode according to the electrode manual. Set the meter measurement mode to mV.
2. Rinse the pH electrode with distilled water, blot it dry with a lint-free tissue and place the pH electrode into a pH 4.01 buffer at approximately 25 °C.
3. Wait for the measurement to stabilize and record the mV value of the pH 4.01 buffer when the measurement is stable.
4. Remove the pH electrode from the pH 4.01 buffer.
5. Rinse the pH electrode with distilled water, blot it dry with a lint-free tissue and place the pH electrode into a pH 7.00 buffer at approximately 25 °C.
6. Wait for the measurement to stabilize and record the mV value of the pH 7.00 buffer when the measurement is stable.
7. The mV reading of the pH electrode in pH 4 buffer should be +117 to +236 mV and in pH 7 buffer should be -59 to +59 mV. If the mV readings are in the correct ranges, the pH electrode is capable of performing automatic buffer recognition. If the mV readings are not in the correct ranges, manually enter the pH buffer values during a pH calibration.

Blank Correct Setting

Orion Star A324 pH/ISE meters and Orion Star A329 pH/ISE/conductivity/RDO/DO meters offer the option to use blank (non-linear) correction for ISE measurements when a multi-point calibration is performed. The blank correction feature uses an algorithm to compensate for the non-linearity of an ion selective electrode in low level standards and samples.

With the blank correction feature enabled, the meter decides whether blank correction is the best measurement strategy by analyzing the electrode response during a multi-point calibration. A separate blank does not have to be run. Graphically, blank correction is equivalent to drawing a smooth curve through the lowest three points of the multi-point calibration and extrapolating to zero concentration based on the assumption of Nernstian electrode behavior.

Multi-point calibrations at the lower limit of detection are desirable when the response of an ion selective electrode is non-linear and cannot be characterized with a one or two point calibration. This is usually seen as a low electrode slope. Generally, the electrode is behaving in a Nernstian manner but the effect of a blank is being observed. See the figure below.

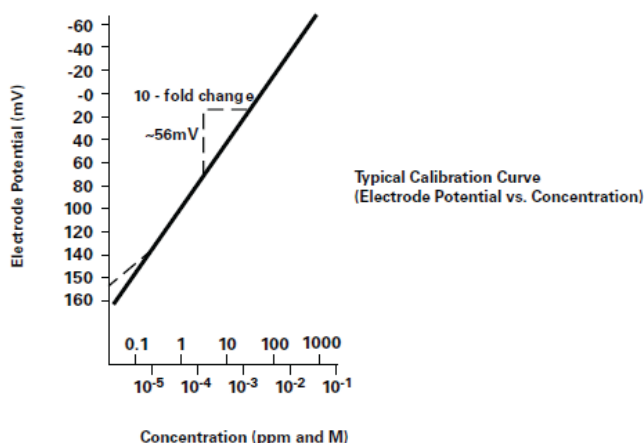

This blank may be a true reagent blank, traces of analyte ion in the reagents or it may be the “mud” value of the electrode. It could also be an interference in the reagents that becomes apparent at low levels of analyte ion, or it could be any combination of these effects. The expanded version of the Nernst equation traditionally used for blank correction is as follows:

$$E = E_0 + S \cdot \log(C + b) \quad \text{where } b \text{ is the blank}$$

In a multi-point calibration, a set of equations is generated and the relationship between them evaluated. For example, the equations generated in a three point calibration would be:

$$E_1 = E_0 + S \cdot \log(C_1 + b)$$

$$E_2 = E_0 + S \cdot \log(C_2 + b)$$

$$E_3 = E_0 + S \cdot \log(C_3 + b)$$

The meter evaluates the relationships between the three potentials E_1 , E_2 and E_3 and the three concentrations C_1 , C_2 and C_3 . If the relationships indicate that blank correction is desired, a blank will automatically be calculated and the non-linearity will be corrected for in a Nernstian manner. If the appropriate conditions are not met, the blank is set at zero and each segment of the multi-point calibration is treated independently.

When all three of the following conditions are met, blank correction is invoked.

1. The concentration of the first standard is zero, or the slope of the electrode between the first and second standards is less than the slope between the second and third.
2. Potential differences between points are significant. For example, $E_3 - E_1 > 10$ mV
3. The blank correction algorithm converges at reasonable blank and slope values. Conditions in steps 1 and 2 prevent failure to converge in most situations. However, the slope will attain any value necessary for convergence to a calculated blank value of $3 \times C_3$.

When blank correction is implemented, the slope value for the electrode may be outside the range of values normally considered acceptable during an ordinary calibration. For best results, calibration standards should be close in range to the expected sample concentrations and should bracket the expected sample concentration. When conditions 1, 2 and 3 are not met, the calibration data is handled by the multi-point calibration method described earlier.

In calibrations with more than three points, a combination of methods is utilized. Automatic blank correction is used if the lowest three points satisfy the criteria and multi-point calibration is used for the other points. The slope calculated in the automatic blank correction algorithm and the slopes for each additional segment are used to calculate the average slope.

Low Level Stability Setting

Orion Star A324 pH/ISE meters and Orion Star A329 pH/ISE/conductivity/RDO/DO meters offer the option to use the low level stability feature when calibrating ion selective electrodes. The low level stability feature improves the accuracy of low concentration ISE measurements by adjusting the timing for calibration points of low level standards, allowing a longer stabilization time for the electrode in the calibration standards. The stabilization time is typically extended to about three to five minutes per calibration point, but will vary based on the actual readings from the electrode during calibration.

Mode and Settings Menu for COND Channel

Use the Mode and Settings menu to customize settings for the conductivity channel of Orion Star A322 conductivity meters, Orion Star A325 pH/conductivity meters and Orion Star A329 pH/ISE/conductivity/RDO/DO meters. Default meter settings are **bold**.

Parameter	Settings	Details
Measure Mode	<ul style="list-style-type: none"> • Conductivity • Salinity • TDS • Resistivity 	Set the displayed measurement mode, the selected mode determines which additional settings are shown and the type of calibration the meter will perform
Read Type	<ul style="list-style-type: none"> • Auto • Continuous • Timed 00:00:03 	Set the read type to determine how the meter takes a measurement and when the measurement is sent to the data log and/or external device
Cell K	Cell K 0.4750	Enter the nominal cell constant (K) value of the conductivity sensor for automatic conductivity calibration
Type (Salinity only)	<ul style="list-style-type: none"> • Practical Salinity • Sea Water 	Set the type of salinity measurement as practical salinity (psu) or natural sea water (ppt)
TDS Factor (TDS only)	TDS Factor 0.49	Enter the TDS factor value for total dissolved solids measurements
Ref. Temp.	<ul style="list-style-type: none"> • 5 °C • 10 °C • 15 °C • 20 °C • 25 °C 	Set the reference temperature for temperature compensated measurements, readings are adjusted to the selected reference temperature when the temperature compensation setting is active
Temp. Comp.	<ul style="list-style-type: none"> • Off • Linear • nLFn • nLFu • EP 	Set the temperature compensation type as linear, nLFn (non linear natural water), nLFu (non linear ultra pure water), EP (compensation off with alarm when values are outside EP requirements for ultra pure water) or off
Temp. Coeff.	Temp. Coefficient 2.10	Enter the temperature coefficient used with the linear temperature compensation setting
Stability	<ul style="list-style-type: none"> • Smart Stability • Fast • Medium • Slow 	Set when a measurement is recognized as stable, Smart Stability compensates for measurement conditions and optimizes the meter response time
Averaging	<ul style="list-style-type: none"> • Off • Automatic Smart 	Set averaging for faster measurement stability, Automatic Smart compensates for measurement conditions and optimizes the meter response time
Limit Alarm	<ul style="list-style-type: none"> • Limit Alarm Off On • Alarm Settings High High/Low Low • High Limit • Low Limit 	Set the limit alarm off or on, when alarm is on – set the alarm setting as high, high/low or low and then enter the appropriate measurement limit values The limit alarm is triggered when the measurement goes above the high limit or below the low limit
Cal Due Alarm (Conductivity only)	<ul style="list-style-type: none"> • Cal Due Alarm On Off • Cal Due Limit 12 Hrs 	Set the calibration due alarm off or on, when on – enter the calibration interval in hours (1 to 9998 hrs) The calibration due alarm is triggered after the set time has elapsed without performing a calibration
Cell Type	<ul style="list-style-type: none"> • Standard • USP 	Set the type of conductivity sensor as standard (most sensors) or USP (2-cell sensors in ultra pure water)

Cell K Setting

Orion Star A322 conductivity meters, Orion Star A325 pH/conductivity meters and Orion Star A329 pH/ISE/conductivity/RDO/DO meters are capable of automatically recognizing Thermo Scientific Orion 100 μS conductivity standard, 1413 μS conductivity standard and 12.9 mS conductivity standard when the nominal cell constant (K) value of the conductivity sensor is entered in the setup menu.

Catalog Number	Description
011008	Orion 100 μS conductivity standard, 5 x 60 mL
011007	Orion 1413 μS conductivity standard, 5 x 60 mL
01100710	Orion 1413 μS conductivity standard, 10 individual use pouches
011006	Orion 12.9 mS conductivity standard, 5 x 60 mL
01100610	Orion 12.9 mS conductivity standard, 10 individual use pouches

The nominal cell constant (K) values for Thermo Scientific Orion conductivity sensors compatible with Star A320 series conductivity meters are listed below.

Catalog Number	Description	Measurement Range	Nominal Cell Constant
013005MD	Orion 4-cell conductivity/temperature sensor with 1.5 meter (5 foot) cable	1 $\mu\text{S}/\text{cm}$ to 200 mS/cm	0.475 cm^{-1}
013010MD	Orion 4-cell conductivity/temperature sensor with 3 meter (10 foot) cable	1 $\mu\text{S}/\text{cm}$ to 200 mS/cm	0.475 cm^{-1}
013020MD	Orion 4-cell conductivity/temperature sensor with 6 meter (20 foot) cable	1 $\mu\text{S}/\text{cm}$ to 200 mS/cm	0.475 cm^{-1}
013025MD	Orion 4-cell conductivity/temperature sensor with 10 meter (32 foot) cable	1 $\mu\text{S}/\text{cm}$ to 200 mS/cm	0.475 cm^{-1}
013605MD	Orion 4-cell conductivity/temperature sensor with 1.5 (5 foot) meter cable	10 $\mu\text{S}/\text{cm}$ to 200 mS/cm	0.55 cm^{-1}
013610MD	Orion 4-cell conductivity/temperature sensor with 3 meter (10 foot) cable	10 $\mu\text{S}/\text{cm}$ to 200 mS/cm	0.55 cm^{-1}
013016MD	Orion pure water 2-cell conductivity/temperature sensor with 1.5 meter (5 foot) cable	0.01 $\mu\text{S}/\text{cm}$ to 300 $\mu\text{S}/\text{cm}$	0.1 cm^{-1}
011510MD	Orion 2-cell conductivity/temperature sensor with 3 meter (10 foot) cable	10 $\mu\text{S}/\text{cm}$ to 200 mS/cm	1.0 cm^{-1}
011050MD	Orion 2-cell conductivity/temperature sensor with 1.5 meter (5 foot) cable	1 $\mu\text{S}/\text{cm}$ to 20 mS/cm	1.0 cm^{-1}
018020MD	Orion high range 2-cell conductivity sensor with 1.5 meter (5 foot) cable	10 $\mu\text{S}/\text{cm}$ to 2000 mS/cm	10 cm^{-1}

Reference Temperature, Temperature Compensation and Coefficient Settings

Orion Star A322 conductivity meters, Orion Star A325 pH/conductivity meters and Orion Star A329 pH/ISE/conductivity/RDO/DO meters offer several options for temperature compensated conductivity measurements. Temperature has a large effect on the conductivity value of a solution. The temperature compensation feature allows the meter to use the sample conductivity and temperature readings to calculate and display the conductivity that the sample would be expected to have at a selected reference temperature, such as 25 °C. To accurately use the temperature compensation feature, select the proper type of temperature compensation for the samples to be measured; set the required reference temperature as 5 °C, 10 °C, 15 °C, 20 °C or 25 °C; and use a conductivity sensor with built-in ATC temperature probe. The options for temperature compensation are:

- Linear – uses the temperature coefficient value to apply a constant percent correction factor to every degree change in temperature. A few common linear coefficient values are:

Solution (25 °C to 50 °C)	Temperature Coefficient (% / °C)
Sugar Syrup	5.64
Ultra Pure Water	4.55
98% Sulfuric Acid	2.84
Salt (NaCl)	2.12
Dilute Ammonia	1.88
5% NaOH	1.72
10% HCl	1.32
5% Sulfuric Acid	0.96

- nLFn (non-linear ultra pure non-degassed water) – applies a non-constant correction factor to pure water samples that have a varying response to changes in temperature. This mode is for temperature compensated readings of low conductivity waters that are in equilibrium with the carbon dioxide in air, such as pure waters reading near 1 $\mu\text{S}/\text{cm}$ at 25 °C and natural waters having a composition comparable to natural ground, well or surface waters.
- nLFu (non-linear ultra pure degassed water) – applies a non-constant correction factor to pure water samples that have a varying response to changes in temperature. This mode is for temperature compensated readings of ultra pure water that contains no air and no carbon dioxide, such as ultra pure water (18 megohms resistance or higher) directly from the source without aeration.
- EP – no temperature correction is applied (temperature compensation turned off) and a warning is displayed if the measured conductivity value is over the EP requirement for pure water at the measured sample temperature.
- Off - no temperature correction is applied and the actual conductivity value is displayed at the measured sample temperature.

Salinity Type Setting

Orion Star A322 conductivity meters, Orion Star A325 pH/conductivity meters and Orion Star A329 pH/ISE/conductivity/RDO/DO meters offer two salinity types: practical salinity and natural sea water. Practical salinity measurements are based on relating the sample measurement to the reading of a standard potassium chloride (KCl) solution at 15 °C. Orion Star A320 series conductivity meters will automatically temperature compensate and report the expected practical salinity result as practical salinity units (psu) at 15 °C when using a conductivity sensor with built-in temperature. Natural sea water measurements use a historic convention known as UNESCO 1966 and Orion Star A320 series conductivity meters will report the expected natural sea water result as parts per thousand (ppt).

TDS Factor Setting

Orion Star A322 conductivity meters, Orion Star A325 pH/conductivity meters and Orion Star A329 pH/ISE/conductivity/RDO/DO meters measure TDS as the total amount of dissolved inorganic material in a solution. The dissolved inorganic material carries a current that is measured by the conductivity sensor. Since there is a direct relationship between conductivity and TDS, conductivity readings are used to estimate the presence of inorganic material using the TDS factor entered in the setup menu.

The standard method of determining TDS involves evaporating a sample to dryness at 180 °C and weighing the residue. The TDS factor is calculated by taking the residue weight and dividing it by the sample conductivity. Subsequent conductivity readings are multiplied by the TDS factor to determine the TDS value of the sample.

Cell Type Setting

Orion Star A322 conductivity meters, Orion Star A325 pH/conductivity meters and Orion Star A329 pH/ISE/conductivity/RDO/DO meters accept 2-cell and 4-cell conductivity sensors and allows the type of conductivity sensor to be set as Standard (most conductivity sensors) or USP (for the ultra pure water conductivity sensor, Catalog Number 013016MD, when disabling temperature compensation).

Mode and Settings Menu for DO/RDO Channel

Use the Mode and Settings menu to customize settings for the dissolved oxygen channel of Orion Star A323 RDO/DO meters, Orion Star A326 pH/RDO/DO meters and Orion Star A329 pH/ISE/conductivity/RDO/DO meters. Default meter settings are **bold**.

Parameter	Settings	Details
Measure Mode	<ul style="list-style-type: none"> DO – Polarographic RDO Auto 	Set the type of dissolved oxygen sensor connected to the meter as DO polarographic or RDO optical or select Auto and the meter will automatically detect which type of dissolved oxygen sensor is connected and update the displayed measurement mode
Measure Unit	<ul style="list-style-type: none"> mg/L % sat 	Set the units displayed with the dissolved oxygen measurement value
Resolution (% saturation)	1 Decimal Place 1 2 Decimal Places 0.1	Set the resolution of the dissolved oxygen measurement value as percent saturation
Resolution (mg/L)	1 Decimal Place 0.1 2 Decimal Places 0.01	Set the resolution of the dissolved oxygen measurement value as mg/L
Read Type	<ul style="list-style-type: none"> Auto Continuous Timed 00:00:03 	Set the read type to determine how the meter takes a measurement and when the measurement is sent to the data log and/or external device
Baro Press	<ul style="list-style-type: none"> Auto Manual 760.0mmHg 	Set the automatic barometric pressure compensation source as the internal barometer (Auto) or a manually entered barometric pressure value (Manual)
Salinity Correct	<ul style="list-style-type: none"> Auto (Practical Salt)* Manual 0.0 	Enter the salinity value of samples for automatic salinity correction of dissolved oxygen measurements
Stability	<ul style="list-style-type: none"> Smart Stability Fast Medium Slow 	Set when a measurement is recognized as stable, Smart Stability compensates for measurement conditions and optimizes the meter response time
Averaging	<ul style="list-style-type: none"> Off Automatic Smart 	Set averaging for faster measurement stability, Automatic Smart compensates for measurement conditions and optimizes the meter response time
Limit Alarm	<ul style="list-style-type: none"> Limit Alarm Off On Alarm Settings High High/Low Low High Limit Low Limit 	Set the limit alarm off or on, when the limit alarm is on – select the alarm settings as high, high/low or low and then enter the measurement limit values The limit alarm is triggered when a measurement goes above the entered high limit or below the entered low limit
Cal Due Alarm	<ul style="list-style-type: none"> Cal Due Alarm On Off Cal Due Limit 12 Hrs 	Set the calibration due alarm off or on, when the cal due alarm is on – enter the calibration time interval in hours (1 to 9998 hours) The cal due alarm is triggered after the entered time has elapsed without a calibration being performed
RDO Cap Life (RDO only)	RDO Cap Life 0.0 Serial Number 0	View the remaining RDO optical DO sensor cap life in days and the serial number

* Orion Star A329 meters offer the option to use the measured conductivity value of a sample for automatic salinity correction of dissolved oxygen measurements.

Barometric Pressure Compensation Setting

Orion Star A323 RDO/DO meters, Orion Star A326 pH/RDO/DO meters and Orion Star A329 pH/ISE/conductivity/RDO/DO meters have an internal barometer that can be used for automatic pressure compensated dissolved oxygen readings. Manual entry of the barometric pressure can be used for automatic pressure compensated dissolved oxygen readings, which is useful when dissolved oxygen is measured with a submerged sensor or in a pressurized vessel. The pressure value must be entered as mm Hg.

1 mm Hg = 0.03937 inch Hg = 1.3332 hPa (mBar) = 0.01934 PSI

Salinity Correction Setting

Orion Star A323 RDO/DO meters, Orion Star A326 pH/RDO/DO meters and Orion Star A329 pH/ISE/conductivity/RDO/DO meters are capable of performing automatic salinity correction for dissolved oxygen readings (measured as mg/L) when the salinity value of the sample is manually entered as ppt (parts per thousand) in the setup menu.

Orion Star A329 pH/ISE/conductivity/RDO/DO meters offer the additional option of using the measured conductivity value of a sample for automatic salinity correction of dissolved oxygen measurements. The conductivity sensor and dissolved oxygen sensor must be placed in the same sample during the dissolved oxygen measurement for proper salinity correction.

Conductivity at 20 °C (mS/cm)	Salinity Correction Value (ppt)	Conductivity at 20 °C (mS/cm)	Salinity Correction Value (ppt)	Conductivity at 20 °C (mS/cm)	Salinity Correction Value (ppt)
5	3	20	13	35	25
6	4	21	14	36	25
7	4	22	15	37	26
8	5	23	15	38	27
9	6	24	16	39	28
10	6	25	17	40	29
11	7	26	18	42	30
12	8	27	18	44	32
13	8	28	19	46	33
14	9	29	20	48	35
15	10	30	21	50	37
16	10	31	22	52	38
17	11	32	22	54	40
18	12	33	23	56	42
19	13	34	24		

Calculated from the International Oceanographic Tables, Vol. 1, National Institute of Oceanography of Great Britain, Womley, Godaming, Surrey, England and Unesco, Paris 1971

Temperature Menu

Orion Star A320 series portable meters offer a Temperature menu used to customize temperature settings for each channel by manually entering a temperature value, selecting the temperature units as °C or °F and performing a temperature calibration on an ATC probe, conductivity sensor or dissolved oxygen sensor with built-in temperature. Orion Star A326 pH/RDO/DO meters and Orion Star A329 pH/ISE/conductivity/RDO/DO meters also offer the option to use one temperature source for all measurement channels.

Meter Model	Channel	Temperature Menu	Menu Options
Star A321 pH Meter	pH Channel	• Manual Temp Value	Enter temperature value
		• Temperature Unit	• Celsius • Fahrenheit
		• Temperature Calibration	• ATC
Star A322 Conductivity Meter	COND Channel	• Manual Temp Value	Enter temperature value
		• Temperature Unit	• Celsius • Fahrenheit
		• Temperature Calibration	• ATC
Star A323 RDO/DO Meter	DO/RDO Channel	• Temperature Unit	• Celsius • Fahrenheit
		• Temperature Calibration <i>(polarographic DO sensor only)</i>	• Solution Temperature • Membrane Temperature • Sol & Mem Temp
Star A324 pH/ISE Meter	pH/ISE Channel	• Manual Temp Value	Enter temperature value
		• Temperature Unit	• Celsius • Fahrenheit
		• Temperature Calibration	• ATC
Star A325 pH/ Conductivity Meter	pH Channel	• Manual Temp Value	Enter temperature value
		• Temperature Unit	• Celsius • Fahrenheit
		• Temperature Calibration	• ATC
	COND Channel	• Manual Temp Value	Enter temperature value
		• Temperature Unit	• Celsius • Fahrenheit
		• Temperature Calibration	• ATC

Meter Model	Channel	Temperature Menu	Menu Options
Star A326 pH/RDO/DO Meter	pH Channel	• Manual Temp Value	Enter temperature value
		• Temperature Unit	• Celsius • Fahrenheit
		• Temperature Calibration	• ATC • Solution Temperature • Membrane Temperature • Sol & Mem Temperature • ATC, Sol & Mem Temp
		• Temperature Input	• ATC • DO Probe • Manual
	DO/RDO Channel	• Temperature Unit	• Celsius • Fahrenheit
		• Temperature Calibration <i>(polarographic DO sensor only)</i>	• Solution Temperature • Membrane Temperature • Sol & Mem Temp
Star A329 pH/ISE/ Conductivity/RDO/DO Meter	pH Channel	• Manual Temp Value	Enter temperature value
		• Temperature Unit	• Celsius • Fahrenheit
		• Temperature Calibration	• ATC • Solution Temperature • Membrane Temperature • Sol & Mem Temperature • ATC, Sol & Mem Temp
		• Temperature Input	• ATC • DO Probe • Manual
	COND Channel	• Manual Temp Value	Enter temperature value
		• Temperature Unit	• Celsius • Fahrenheit
		• Temperature Calibration	• ATC • Solution Temperature • Membrane Temperature • Sol & Mem Temperature • ATC, Sol & Mem Temp
		• Temperature Input	• ATC • DO Probe • Manual
	DO/RDO Channel	• Temperature Unit	• Celsius • Fahrenheit
		• Temperature Calibration	• Solution Temperature • Membrane Temperature • Sol & Mem Temp

Manual Temperature Value

1. In the measurement mode, press the **setup** key.
2. Press the **p**, **q**, **t** or **u** key to highlight pH Channel, pH/ISE Channel or COND Channel and press the **f3 (select)** key.
3. Press the **p** or **q** key to highlight Temperature and press the **f3 (select)** key.
4. Press the **p** or **q** key to highlight Manual Temp Value and press the **f3 (select)** key.
5. Press the **f3 (edit)** key access the popup number entry screen and enter the sample temperature value.
 - a. Press the **p**, **q**, **t** or **u** key to highlight a number, decimal point or negative sign and then press the **f3 (enter)** key to select the highlighted item. Repeat until the sample temperature value is shown at the top of the screen.
 - b. Press the **f2 (done)** key to save the value and exit the number entry screen.
6. Press the **f1 (back)** key to return to the main temperature menu and press the **measure (esc)** key to return to the measurement mode.

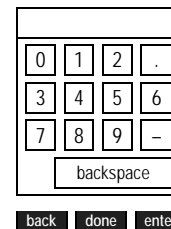

Temperature Unit

1. In the measurement mode, press the **setup** key.
2. Press the **p**, **q**, **t** or **u** key to highlight pH Channel, pH/ISE Channel, COND Channel or DO/RDO Channel and press the **f3 (select)** key.
3. Press the **p** or **q** key to highlight Temperature and press the **f3 (select)** key.
4. Press the **p** or **q** key to highlight Temperature Unit and press the **f3 (select)** key.
5. Press the **p** or **q** key to highlight Celsius or Fahrenheit and press the **f3 (select)** key.
6. Press the **measure (esc)** key to return to the measurement mode.

Temperature Calibration

When using Orion Star A320 series portable meters, a temperature calibration can be performed on an ATC probe, conductivity sensor with built-in temperature or polarographic dissolved oxygen sensor with built-in temperature when the probe or sensor is connected to the meter. Use the temperature calibration function only when necessary, since the meter has a relative temperature accuracy of $\pm 0.1^\circ\text{C}$ and ATC probes have varying accuracies, usually $\pm 0.5^\circ\text{C}$ to $\pm 2^\circ\text{C}$. Since the temperature offset calculated during the calibration is applied to all future temperature measurements, recalibrate the temperature if a different ATC probe is used.

1. In the measurement mode, press the **setup** key.
2. Press the **p**, **q**, **t** or **u** key to highlight pH Channel, pH/ISE Channel, COND Channel or DO/RDO Channel and press the **f3 (select)** key.
3. Press the **p** or **q** key to highlight Temperature and press the **f3 (select)** key.
4. Press the **p** or **q** key to highlight Temperature Calibration and press the **f3 (select)** key.
5. Press the **p** or **q** key to highlight ATC and press the **f3 (select)** key.
 - a. If using the Star A323 meter, press the **p** or **q** key to highlight Solution Temperature, Membrane Temperature or Sol & Mem Temperature and press the **f3 (select)** key.
 - b. If using the Star A326 or Star A329 meter, press the **p** or **q** key to highlight ATC, Solution Temperature, Membrane Temperature, Sol & Mem Temperature or ATC, Sol & Mem Temp and press the **f3 (select)** key.
6. Place the ATC probe and/or sensor into a solution with a known, stable temperature. Two NIST-traceable thermometers should be used to measure and verify the temperature.
7. Wait for the temperature value on the meter to stabilize and then press the **f3 (edit)** key to access the popup number entry screen and enter the temperature value.
 - a. Press the **p**, **q**, **t** or **u** key to highlight a number, decimal point or negative sign and then press the **f3 (enter)** key to select the highlighted item. Repeat until the desired temperature value is shown at the top of the screen.
 - b. Press the **f2 (done)** key to exit the number entry screen.
8. Press the **f2 (accept)** key to save the entered temperature value.
9. Press the **f1 (meas)** key to return to the measurement mode.

Temperature Calibration for Meters with Multiple Temperature Inputs

When a polarographic dissolved oxygen sensor with two temperature inputs is connected with an Orion Star A323 RDO/DO meter, Orion Star A326 pH/RDO/DO meter or Orion Star A329 pH/ISE/conductivity/RDO/DO meter, the solution temperature input and membrane temperature input can be calibrated separately or together.

When an ATC probe (or conductivity sensor with built-in temperature) and polarographic dissolved oxygen sensor are both connected to the Orion Star A326 pH/RDO/DO meter or Orion Star A329 pH/ISE/conductivity/RDO/DO meter, the temperature calibration for both inputs can also be performed together.

Temperature Input

When using the Orion Star A326 pH/RDO/DO meter or Orion Star A329 pH/ISE/conductivity/RDO/DO meter, a dissolved oxygen sensor with built-in temperature can be set as the temperature input source for all measurements. For example, when using a pH electrode without an ATC probe, the dissolved oxygen sensor with built-in temperature can be used as the temperature source for pH measurements, as long as both the pH electrode and dissolved oxygen sensor are placed in the same solution.

1. In the measurement mode, press the **setup** key.
2. Press the **p**, **q**, **t** or **u** key to highlight pH Channel, pH/ISE Channel or COND Channel and press the **f3 (select)** key.
3. Press the **p** or **q** key to highlight Temperature and press the **f3 (select)** key.
4. Press the **p** or **q** key to highlight Temperature Input and press the **f3 (select)** key.
5. Press the **p** or **q** key to highlight ATC, DO Probe or Manual and press the **f3 (select)** key.
6. Press the **measure (esc)** key to return to the measurement mode.

Instrument Settings Setup Menu

Use the Instrument Settings menu to update meter settings for data transfer, data log, date and time, language, sounds, display contrast, auto-shutoff, user ID and sample ID.

Instrument Setting	Options	Details
Export Data	<ul style="list-style-type: none"> • Printing Off On • Comm Setup RS232 USB • Data Format Printer PC (CSV) • Comm Config 1200 9600 2400 19200 4800 38400 	<p>Access the data export menu to set data transfer settings for exporting measurement and calibration information to a printer or computer</p> <p>Turn printing on to allow data transfer from the meter to an external device, select the data transfer format as printer (standard text) or PC (comma delimited text) and set the meter baud rate to match the printer or computer baud rate</p> <p>The meter will automatically detect when an RS232 or USB cable is connected to a meter port</p>
Data Log	<ul style="list-style-type: none"> • Off • On 	Turn data logging on to save measurement data to the data log according to the selected read type
Date and Time	<ul style="list-style-type: none"> • Date DD/MM/YY MM/DD/YY Date: 01/01/12 • Time 12 Hour Clock Time: 02:30 PM 24 Hour Clock Time: 14:30 	<p>Use the date setting to select the date format as day/month/year (DD/MM/YY) or month/day/year (MM/DD/YY) and then enter the month, day and year values</p> <p>Use the time setting to set the time format as 12 hour clock or 24 hour clock and then enter the hour and minute values</p>
Language	<ul style="list-style-type: none"> • English • Español • Deutsch • Français • Italiano • 中文(Chinese) 	Set the language to be used for the meter interface, additional languages (including Portuguese and Korean) are available with software updates on our website at www.thermoscientific.com/OrionMeters
Key Press Beep	<ul style="list-style-type: none"> • Off • On 	Turn the audible beep on or off each time a meter key is pressed
Alarm Beep	<ul style="list-style-type: none"> • Off • On 	Turn the audible beep on or off when an alarm is triggered
Contrast		Adjust the display contrast higher or lower to improve display viewing in different light conditions
Auto Shut Off	<ul style="list-style-type: none"> • Off • On 	Turn on function to automatically power off the meter when no keys are pressed for 20 minutes
User ID	ABCDE	Enter a user ID value (up to six characters) using the alphanumeric entry screen
Sample ID	<ul style="list-style-type: none"> • Off • Manual • Auto Increment 	Set sample ID as off, manual (up to six alphanumeric characters) or auto incremental (up to six numbers that are automatically increased for each measurement)

Log View Menu

Use the Log View menu to access the data log and calibration log. All information in the data and calibration logs is protected by the meter's nonvolatile memory, so stored information is saved in the meter even when it is not connected to a power supply.

Data Log

Orion Star A320 series portable meters offer a 5000 point data log. Each point includes the actively displayed measurements, depending on the meter model and display configuration, with date and time stamp. When the data log function is turned on, the read type selected for each displayed channel (Auto-Read, Continuous or Timed) determines how the point is saved to the data log.

1. In the measurement mode, press the **setup** key.
2. Press the **p**, **q**, **t** or **u** key to highlight View Log and press the **f3 (select)** key.
3. Press the **p** or **q** key to highlight Data Log and press the **f2 (select)** key.
4. The meter will display a list of the data log points. The list shows the sequential number of the points and the data and time the point was saved.
5. To view measurement information for an individual point:
 - a. Press the **p** or **q** key to highlight a point and then press the **f2 (select)** key.
 - b. Press the **f1 (back)** key to return to the list of data log points.
6. To export the data log to a printer or computer:
 - a. Press the **f3 (options)** key, press the **p** or **q** key to highlight Log Export and then press the **f2 (accept)** key.
 - b. Press the **p** or **q** key to highlight Today, Last 10, Range or All and then press the **f2 (accept)** key.
 - i. If Range is selected, press the **p** or **q** key to highlight the number of the first (from) and last (to) points to be exported, use the popup number entry screen to edit the numbers and press the **f2 (accept)** key to save the entered range.
 - c. Press the **f2 (yes)** key to confirm that the meter is interfaced with a printer or computer. The meter will automatically return to the data log list once the export is completed.
7. To clear the data log memory:
 - a. Press the **f3 (options)** key, press the **p** or **q** key to highlight Log Clear and then press the **f2 (accept)** key.
 - b. Press the **f2 (yes)** key to confirm erasing the entire data log from the meter's memory.
 - c. Press the **f3 (edit)** key, use the popup number entry screen to enter the default meter password of 111111 and then press the **f2 (done)** key.
 - d. Press the **f2 (accept)** key and wait for the data log to be cleared.

Calibration Log

Orion Star A320 series meters save up to ten of the most recent calibrations per channel.

1. In the measurement mode, press the **setup** key.
2. Press the **p**, **q**, **t** or **u** key to highlight View Log and press the **f3 (select)** key.
3. Press the **p** or **q** key to highlight Calibration Log and press the **f2 (select)** key.
4. Press the **p** or **q** key to highlight pH-Channel, pH/ISE-Channel, Conductivity-Channel or DO/RDO-Channel and press the **f2 (select)** key.
 - a. If pH-Channel is selected, press the **p** or **q** key to highlight pH, RmV or ORP and press the **f2 (select)** key.
 - b. If pH/ISE-Channel is selected, press the **p** or **q** key to highlight pH, RmV, ORP or ISE and press the **f2 (select)** key.
 - c. If Conductivity-Channel is selected, press the **p** or **q** key to highlight Conductivity, Resistivity, TDS or Salinity and press the **f2 (select)** key.
 - d. If DO/RDO-Channel is selected, press the **p** or **q** key to highlight DO or RDO and press the **f2 (select)** key.
5. The meter will display a list of calibrations for the selected channel and calibration mode. The list shows the sequential number of the calibration log and the data and time the calibration was completed.
6. To view detailed information for an individual calibration, press the **p** or **q** key to highlight a calibration and then press the **f2 (select)** key.
 - a. To export the calibration to a printer or computer, press the **f2 (print)** key.

Exported Calibration Log Example,
Printer Data Format:

```

-----
Thermo Scientific (c) 2011
A211 pH
Meter S/N      X01036
SN Rev        3.04
--Calibration Report--
pH
12/27/14 16:43:00
Point 1
pH              2.00 pH
mV              290.5 mV
Temperature     25.0 C
Point 2
pH              4.01 pH
mV              174.3 mV
Temperature     25.0 C
Point 3
pH              7.00 pH
mV              0.0 mV
Temperature     25.0 C
Point 4
pH              10.01 pH
mV              -173.6 mV
Temperature     25.0 C
Point 5
pH              12.00 pH
mV              -289.4 mV
Temperature     25.0 C
Slope1          97.7 %
Slope2          99.5 %
Slope3          97.5 %
Slope4          99.4 %
E1              1.5 mV
E2              0.0 mV
E3              0.0 mV
E4              1.7 mV

Average Slope   99.0 %
Calibration     #3

Operator
Signature_____

```

Diagnostics Menu

Use the Diagnostics Menu to initiate a meter reset, test electrode stability, perform a meter self test or view meter and module serial numbers and software revisions.

- **Factory Reset** – All meter settings are reset to factory defaults. Data log, calibration log and methods are deleted. Use the default meter password of 111111 to complete the reset.
- **User Reset** – All channel-specific measurement, calibration and alarm settings as well as all instrument settings are reset to factory defaults and methods are erased. Data log and calibration log are retained.
- **Self Test** – Tests the meter accuracy. A self test is also performed automatically by the meter at each power up.
- **Stability Test** – Tests the stability of an electrode by measuring the raw input reading per minute drift and noise.
- **About Meter** – Displays the meter model, serial number and software revision.

Meter Self Test Procedure

1. In the measurement mode, press the **setup** key.
2. Press the **p**, **q**, **t** or **u** key to highlight Diagnostics and press the **f3 (select)** key.
3. Press the **p** or **q** key to highlight Self Test and press the **f2 (select)** key.
4. Disconnect all electrodes and sensors from the meter, attach the BNC shorting cap to the BNC input if applicable and press the **f2 (yes)** key.
5. Press the **f2 (yes)** key to start the self test.
6. The meter will perform the self test. Once Self Test Passed is displayed, press the **f1 (esc)** key and the meter will automatically proceed to the measurement mode.

Meter Verification Procedure (pH and pH/ISE Channels Only)

1. After completing the self test, the meter will return to the measurement mode. Keep all of the electrodes and sensors disconnected from the meter and keep the BNC shorting cap attached to the BNC input on the meter.
2. Set the measurement mode to pH. The meter should read a steady 7.000 pH \pm 0.002 pH.
 - a. If the meter does not read a steady 7.000 \pm 0.002, perform a one point pH calibration with the BNC shorting cap attached to the BNC input. Set the pH value to 7.000 and the slope value to 100.0. Refer to the pH Calibration section for detailed instructions.
3. Set the measurement mode to mV. The meter should read a steady 0.0 mV \pm 0.2 mV.
 - a. If the meter does not read a steady 0.0 mV \pm 0.2 mV with the BNC shorting cap attached to the BNC input, contact Technical Support.

Electrode Stability Test Procedure

1. In the measurement mode, press the **setup** key.
2. Press the **p**, **q**, **t** or **u** key to highlight Diagnostics and press the **f3 (select)** key.
3. Press the **p** or **q** key to highlight Stability Test and press the **f2 (select)** key.
4. Press the **p** or **q** key to highlight pH-Channel, pH/ISE-Channel, Conductivity-Channel or DO/RDO-Channel and press the **f2 (next)** key.
5. Make sure the electrode or sensor to be tested is connected to the channel selected in the previous step and press the **f2 (yes)** key.
6. Place the electrode or sensor in an appropriate solution with a stable temperature and press the **f2 (yes)** key.
 - a. Thermo Scientific Orion pH 7.00 buffer (Catalog Number 910107, 910760 or 910710) is recommended for testing a pH electrode.
 - b. Thermo Scientific Orion ORP standard (Catalog Number 967901 or 967961) is recommended for testing an ORP electrode.
 - c. A calibration standard with a moderate concentration of the ion of interest is recommended for testing an ion selective electrode (ISE).
 - d. Thermo Scientific Orion 1413 μS conductivity standard (Catalog Number 011007 or 01100710) is recommended for testing most conductivity sensors. Thermo Scientific Orion 100 μS conductivity standard (Catalog Number 011008) is recommended for testing ultra pure water conductivity sensors.
 - e. A prepared water-saturated air calibration sleeve is recommended for testing RDO optical and polarographic dissolved oxygen sensors.
7. The meter will perform the stability test and show the raw input reading per minute drift and noise on the display.
8. The meter will display Stability Test Passed or Stability Test Failed. Press the **f1 (esc)** key to return to the measurement mode.

4

CHAPTER 4 Using the pH or pH/ISE Channel

Use the Orion Star A321 pH meter, Orion Star A325 pH/conductivity meter or Orion Star A326 pH/RDO/DO meter to measure pH, mV, relative mV, ORP and temperature. Use the Orion Star A324 pH/ISE meter or Orion Star A329 pH/ISE/conductivity/RDO/DO meter to measure pH, ion concentration using an ISE (ion selective electrode), mV, relative mV, ORP and temperature. The following chapter provides instructions on connecting electrodes, calibrating the system and measuring these parameters.

Meter and Electrode Preparation

1. Familiarize yourself with general meter operation and prepare the meter and accessories according to the instructions in [Chapter 2 Meter Basics](#).
2. Refer to the instructions in [Chapter 3 Meter Setup Menus](#) to customize measurement, calibration and alarm settings within the pH Channel or pH/ISE Channel setup menu and data transfer, data log, date and time, language, sounds, display contrast, auto-shutoff, user ID and sample ID settings within the Instrument Settings setup menu.
3. Connect all necessary electrodes, probes and sensors to the appropriate meter inputs.
 - a. Connect a pH, ORP or ion selective electrode to the BNC meter input.
 - b. Connect an ATC temperature probe to the 8 pin MiniDIN meter input.
 - c. Connect a reference half-cell electrode to the pin tip meter input (for use when a half-cell sensing electrode with BNC connector is used).
4. Prepare all connected electrodes for use as instructed in the electrode manuals.

pH Calibration Procedure

Orion Star A321 pH meters, Orion Star A324 pH/ISE meters, Orion Star A325 pH/conductivity meters, Orion Star A326 pH/RDO/DO meters and Orion Star A329 pH/ISE/conductivity/RDO/DO meters can perform a pH calibration using one to five pH buffers with easy to follow onscreen instructions to assist with the calibration process.

Always use fresh pH buffers and select buffers that bracket the sample pH and are one to three pH units apart. Prepare the pH electrode according to the instructions in the electrode manual. Connect all electrodes to be used to the appropriate meter inputs.

Make sure the meter measurement mode is set to pH. For Star A325, Star A326 and Star A329 meters, press the **f3 (channel)** key until the pH channel is shown in the measurement mode.

1. Press the **f1 (cal)** key to start the calibration.
 - a. If more than one channel is displayed in the measurement mode, press the **p** or **q** key to highlight pH-Channel or pH/ISE-Channel and press the **f2 (select)** key.
2. Rinse the pH electrode and any other electrodes in use with distilled water, blot gently with a lint-free tissue to remove excess water and place into the pH buffer.
3. When the electrode and buffer are ready, press the **f3 (start)** key.
4. Wait for the pH value on the meter to stabilize and perform one of the following actions:
 - a. Press the **f2 (accept)** key to accept the pH buffer value determined by the automatic buffer recognition function.
or
 - b. Press the **f3 (edit)** key to access the popup number entry screen and manually enter the pH buffer value.
 - i. Press the **p**, **q**, **t** or **u** key to highlight a number or decimal point, press the **f3 (enter)** key to select the highlighted item and repeat until the desired value is shown at the top of the screen.
 - ii. Press the **f2 (done)** key to save the value and exit the number entry screen.
 - iii. Press the **f2 (accept)** key to accept the manually entered value.
5. Press the **f2 (next)** key to proceed to the next pH buffer and repeat steps 2 through 4 or press the **f3 (cal done)** key to save and end the calibration. If five buffers are used, the calibration will save and end once the fifth value is accepted.
 - a. When performing a one point calibration, press the **f2 (accept)** key to accept the displayed slope value or press the **f3 (edit)** key, use the popup number entry screen to enter a new slope value, press the **f2 (done)** key and then press the **f2 (accept)** key.
6. The meter will display the calibration summary including the slope and export the data to the calibration log. Press the **f1 (meas)** key to proceed to the measurement mode or press the **f2 (print)** key to export the calibration data to a printer or computer.

pH Calibration Editing

When the calibration summary is displayed, the calibration editing option can be selected to fix individual points without having to perform a full recalibration.

1. In the calibration summary display (after step 5 in the pH Calibration Procedure), press the **f3 (cal edit)** key.
2. Press the **p** or **q** key to highlight a calibration point to edit and press the **f2 (select)** key.
3. Press the **p** or **q** key to highlight Remeasure, Edit or Delete and press the **f2 (select)** key.
 - a. If Remeasure is selected, repeat steps 2 through 4 in the pH Calibration Procedure.
 - b. If Edit is selected, press the **f3 (edit)** key, use the popup number entry screen to enter a new pH buffer value, press the **f2 (done)** key and then press the **f2 (accept)** key. Select another calibration point to edit or press the **f1 (back)** key.
 - c. If Delete is selected, the calibration point will be deleted. If deleting the point changes it to a one point calibration, enter the slope using the popup number entry screen.
4. The meter will display an updated calibration summary and export the data to the calibration log. Press the **f1 (meas)** key to proceed to the measurement mode or press the **f2 (print)** key to export the calibration data to a printer or computer.

ORP Calibration Procedure (Relative mV Mode)

Orion Star A321 pH meters, Orion Star A324 pH/ISE meters, Orion Star A325 pH/conductivity meters, Orion Star A326 pH/RDO/DO meters and Orion Star A329 pH/ISE/conductivity/RDO/DO meters can perform an ORP calibration in the relative mV (RmV) mode using one standard with easy to follow onscreen instructions to assist with the calibration process.

Use the Thermo Scientific Orion ORP standard (Catalog Number 967901 or 967961) or other ORP standard as desired. Prepare the electrode according to the instructions in the electrode manual. Connect all electrodes to be used to the appropriate meter inputs.

Make sure the meter measurement mode is set to RmV. For Star A325, Star A326 and Star A329 meters, press the **f3 (channel)** key until the RmV channel is shown in the measurement mode.

1. Press the **f1 (cal)** key to start the calibration.
 - a. If more than one channel is displayed in the measurement mode, press the **p** or **q** key to highlight **pH-Channel** or **pH/ISE-Channel** and press the **f2 (select)** key.
2. Rinse the electrode and any other electrodes in use with distilled water, blot gently with a lint-free tissue to remove excess water and place into the standard.
3. When the electrode and standard are ready, press the **f3 (start)** key.
4. Wait for the mV value on the meter to stabilize (indicated by the flashing **stabilizing** or solid **ready** icon) and perform one of the following actions:
 - a. Press the **f2 (accept)** key to accept the mV value.
 - or
 - b. Press the **f3 (edit)** key to access the popup number entry screen and manually enter the mV value expected at the measured temperature.
 - i. Press the **p**, **q**, **t** or **u** key to highlight a number, decimal point or negative sign; press the **f3 (enter)** key to select the highlighted item and repeat until the desired value is shown at the top of the screen.
 - ii. Press the **f2 (done)** key to save the value and exit the number entry screen.
 - iii. Press the **f2 (accept)** key to accept the manually entered value.
5. The meter will display the calibration summary including the mV offset and export the data to the calibration log. Press the **f1 (meas)** key to proceed to the measurement mode or press the **f2 (print)** key to export the calibration data to a printer or computer.

ORP Calibration Procedure (E_H Units)

Orion Star A321 pH meters, Orion Star A324 pH/ISE meters, Orion Star A325 pH/conductivity meters, Orion Star A326 pH/RDO/DO meters and Orion Star A329 pH/ISE/conductivity/RDO/DO meters can perform a one point automatic ORP calibration to the E_H value (relative to the Standard Hydrogen Electrode, 420 mV at 25 °C) when using the following items:

- Thermo Scientific Orion ORP standard (Catalog Number 967901 or 967961)
- Thermo Scientific Orion ORP electrode (Catalog Number 9678BNWP, 9778BNWP, 9180BNMD or 9179BNMD)
- Thermo Scientific Orion 4 M KCl filling solution (Catalog Number 900011) or 4 M KCl gel (in the 9179BNMD electrode)

Orion ORP standard is nonhazardous, stable and will not change over time, so it is an ideal standard for any ORP measurement system. Always use fresh ORP standard. Prepare the ORP electrode according to the instructions in the electrode manual. Connect all electrodes to be used to the appropriate meter inputs.

Make sure the meter measurement mode is set to ORP. For Star A325, Star A326 and Star A329 meters, press the **f3 (channel)** key until the ORP channel is shown in the measurement mode.

1. Press the **f1 (cal)** key to start the calibration.
 - a. If more than one channel is displayed in the measurement mode, press the **p** or **q** key to highlight pH-Channel or pH/ISE-Channel and press the **f2 (select)** key.
2. Rinse the electrode and any other electrodes in use with distilled water, blot gently with a lint-free tissue to remove excess water and place into the standard.
3. When the electrode and standard are ready, press the **f3 (start)** key.
4. Wait for the mV value on the meter to stabilize (indicated by the flashing *stabilizing* or solid *ready* icon) and press the **f2 (accept)** key once the mV value is stable.
5. The meter will display the calibration summary including the mV offset and export the data to the calibration log. Press the **f1 (meas)** key to proceed to the measurement mode or press the **f2 (print)** key to export the calibration data to a printer or computer.

ISE Calibration Procedure

Orion Star A324 pH/ISE meters and Orion Star A329 pH/ISE/conductivity/RDO/DO meters can perform an ion concentration calibration using one to five standards with easy to follow onscreen instructions to assist with the calibration process.

Always use fresh standards and select standards that bracket the sample concentration and are one decade (ten times) apart in concentration. To accurately prepare calibration standards from a stock solution, serial dilution is recommended using calibrated pipettes. If ISA will be added to samples, the same ISA must be added to all standards prior to calibration to ensure a consistent dilution factor. If more than one standard is used for calibration, start with the lowest concentration standard and work up to the highest concentration standard last.

Prepare the ion selective electrode according to the instructions in the electrode manual. Connect all electrodes to be used to the appropriate meter inputs. Make sure the meter measurement mode is set to ISE.

1. Press the **f1 (cal)** key to start the calibration.
2. Rinse the ion selective electrode and any other electrodes in use with distilled water, blot gently with a lint-free tissue to remove excess water and place into the standard.
3. When the electrode and standard are ready, press the **f3 (start)** key.
4. Wait for the value on the meter to stabilize and perform one of the following actions:
 - a. Press the **f2 (accept)** key to accept the displayed concentration value.
 - or
 - b. Press the **f3 (edit)** key to access the popup number entry screen and manually enter the concentration value.
 - i. Press the **p**, **q**, **t** or **u** key to highlight a number or decimal point, press the **f3 (enter)** key to select the highlighted item and repeat until the desired value is shown at the top of the screen.
 - ii. Press the **f2 (done)** key to save the value and exit the number entry screen.
 - iii. Press the **f2 (accept)** key to accept the manually entered value.
5. Press the **f2 (next)** key to proceed to the next standard and repeat steps 2 through 4 or press the **f3 (cal done)** key to save and end the calibration. If five standards are used, the calibration will save and end once the fifth value is accepted.
 - a. When performing a one point calibration, press the **f2 (accept)** key to accept the displayed slope value or press the **f3 (edit)** key, use the popup number entry screen to enter a new slope value, press the **f2 (done)** key and then press the **f2 (accept)** key.
6. The meter will display the calibration summary including the slope and export the data to the calibration log. Press the **f1 (meas)** key to proceed to the measurement mode or press the **f2 (print)** key to export the calibration data to a printer or computer.

ISE Calibration Editing

When the calibration summary is displayed, the calibration editing option can be selected to fix individual points without having to perform a full recalibration.

1. In the calibration summary display (after step 5 in the ISE Calibration Procedure), press the **f3 (cal edit)** key.
2. Press the **p** or **q** key to highlight a calibration point to edit and press the **f2 (select)** key.
3. Press the **p** or **q** key to highlight Remeasure, Edit or Delete and press the **f2 (select)** key.
 - a. If Remeasure is selected, repeat steps 2 through 4 in the ISE Calibration Procedure.
 - b. If Edit is selected, press the **f3 (edit)** key, use the popup number entry screen to enter a new standard value, press the **f2 (done)** key and then press the **f2 (accept)** key. Select another calibration point to edit or press the **f1 (back)** key.
 - c. If Delete is selected, the calibration point will be deleted. If deleting the point changes it to a one point calibration, enter the slope using the popup number entry screen.
4. The meter will display an updated calibration summary and export the data to the calibration log. Press the **f1 (meas)** key to proceed to the measurement mode or press the **f2 (print)** key to export the calibration data to a printer or computer.

Measurement Procedure

Prepare the electrodes according to the instructions in the electrode manuals. Connect all electrodes to be used to the appropriate meter inputs. Make sure the electrodes are recently calibrated and working correctly.

Ensure the meter measurement mode is set to the desired measurement parameter. For Orion Star A325, Orion Star A326 and Orion Star A329 meters, press the **f3 (channel)** key until the desired channel or channels are shown in the measurement mode.

1. Rinse the electrodes with distilled water or appropriate solution, blot gently with a lint-free tissue to remove excess water and place into the sample.
2. Start the measurement and wait for the reading to stabilize or reach the predefined time.
 - a. Auto-Read: Press the **measure (esc)** key to start the measurement.
 - b. Continuous: Measurements will start immediately when in the measurement mode.
 - c. Timed: Measurements will start immediately when in the measurement mode.
3. Once the measurement is stable or reaches the set time, record all applicable parameters.
 - a. Auto-Read: Once the measurement is stable, it will be locked and held on the display and the **AR** icon will remain solid. If the data log function is enabled, the measurement will be exported to the data log.
 - b. Continuous: The flashing **Stabilizing** icon will update to the solid **Ready** icon when the measurement is stable. If the data log function is enabled, press the **log/print** key to export the measurement to the data log.
 - c. Timed: Measurements will be recorded at the predefined time interval. If the data log function is enabled, the **<** icon will be shown when each time interval has elapsed and the measurement is exported to the data log.
4. Remove the electrodes from the sample, rinse with distilled water or appropriate solution, blot gently with a lint-free tissue to remove excess water and place into the next sample.
5. Repeat steps 2 through 4 for all samples. When all samples have been measured, store the electrodes according to the instructions in the electrode manuals.

5

CHAPTER 5 Using the Conductivity Channel

Use the Orion Star A322 conductivity meter, Orion Star A325 pH/conductivity meter or Orion Star A329 pH/ISE/conductivity/RDO/DO meter to measure conductivity, salinity, TDS, resistivity and temperature. The following chapter provides instructions on connecting sensors, calibrating the system and measuring these parameters.

Meter and Sensor Preparation

1. Familiarize yourself with general meter operation and prepare the meter and accessories according to the instructions in [Chapter 2 Meter Basics](#).
2. Refer to the instructions in [Chapter 3 Meter Setup Menus](#) to customize measurement, calibration and alarm settings within the COND Channel setup menu and data transfer, data log, date and time, language, sounds, display contrast, auto-shutoff, user ID and sample ID settings within the Instrument Settings setup menu.
3. Connect all necessary electrodes, probes and sensors to the appropriate meter inputs.
 - a. Connect a conductivity sensor to the 8 pin MiniDIN meter input. If the conductivity sensor has built-in temperature, the temperature will also be measured when the conductivity sensor is connected with the meter.
4. Prepare all connected sensors for use as instructed in the sensor manuals.

Conductivity Calibration Procedure

Orion Star A322 conductivity meters, Orion Star A325 pH/conductivity meters and Orion Star A329 pH/ISE/conductivity/RDO/DO meters can perform a conductivity calibration using one to five conductivity standards with easy to follow onscreen instructions to assist with the calibration process or by the manual entry of the certified conductivity cell constant (K) value.

Always use fresh standards and select standards that are near the expected sample conductivity. Prepare the conductivity sensor according to the instructions in the sensor manual. Connect all sensors to be used to the appropriate meter inputs.

Make sure the meter measurement mode is set to conductivity (Cond). For Star A325 and Star A329 meters, press the **f3 (channel)** key until the conductivity channel is shown in the measurement mode.

Note: For an automatic calibration, enter the nominal cell constant of the conductivity sensor in the channel-specific setup menu and use Orion 100 μS , 1413 μS and/or 12.9 mS standards.

1. Press the **f1 (cal)** key to start the calibration.
 - a. If more than one channel is displayed in the measurement mode, press the ρ or α key to highlight Conductivity-Channel and press the **f2 (select)** key.
2. Rinse the conductivity sensor and any other electrodes in use with distilled water, blot gently with a lint-free tissue to remove excess water and place into the conductivity standard.
3. When the sensor and standard are ready, press the **f3 (start)** key.
4. Wait for the value on the meter to stabilize and perform one of the following actions:
 - a. Press the **f2 (accept)** key to accept the conductivity value determined by automatic standard recognition function (Orion 100 μS , 1413 μS and 12.9 mS standards only).
or
 - b. Press the **f3 (edit)** key to access the popup number entry screen and manually enter the conductivity standard value expected at the measured temperature.
 - i. Press the ρ , α , t or \cup key to highlight a number or decimal point, press the **f3 (enter)** key to select the highlighted item and repeat until the desired value is shown at the top of the screen.
 - ii. Press the **f2 (done)** key to save the value and exit the number entry screen.
 - iii. Press the **f2 (accept)** key to accept the manually entered value.
5. Press the **f2 (next)** key to proceed to the next standard and repeat steps 2 through 4 or press the **f3 (cal done)** key to save and end the calibration. If five standard are used, the calibration will save and end once the fifth value is accepted.
6. The meter will display the calibration summary and export the data to the calibration log. Press the **f1 (meas)** key to proceed to the measurement mode or press the **f2 (print)** key to export the calibration data to a printer or computer.

Conductivity Calibration Editing

When the calibration summary is displayed, the calibration editing option can be selected to fix individual points without having to perform a full recalibration.

1. In the calibration summary display (after step 5 in the Conductivity Calibration Procedure), press the **f3 (cal edit)** key.
2. Press the **␣** or **␣** key to highlight a calibration point to edit and press the **f2 (select)** key.
3. Press the **␣** or **␣** key to highlight Remeasure, Edit or Delete and press the **f2 (select)** key.
 - a. If Remeasure is selected, repeat steps 2 through 4 in the Calibration Procedure.
 - b. If Edit is selected, press the **f3 (edit)** key, use the popup number entry screen to enter a new conductivity standard value, press the **f2 (done)** key and then press the **f2 (accept)** key. Select another calibration point to edit or press the **f1 (back)** key.
 - c. If Delete is selected, the calibration point will be deleted.
4. The meter will display an updated calibration summary and export the data to the calibration log. Press the **f1 (meas)** key to proceed to the measurement mode or press the **f2 (print)** key to export the calibration data to a printer or computer.

Alternative Certified Cell Constant Entry Calibration Procedure

When using the cell constant entry calibration procedure, enter the certified cell constant (K) value that is printed on the conductivity sensor cable or certificate of calibration.

1. Press the **f1 (cal)** key to start the calibration.
 - a. If more than one channel is displayed in the measurement mode, press the **␣** or **␣** key to highlight Conductivity-Channel and press the **f2 (select)** key.
2. Press the **f2 (cell K)** key.
3. Wait for the conductivity value on the meter to stabilize and then press the **f3 (edit)** key to access the popup number entry screen and enter the certified cell constant value.
 - a. Press the **␣**, **␣**, **␣** or **␣** key to highlight a number or decimal point, press the **f3 (enter)** key to select the highlighted item and repeat until the desired value is shown at the top of the screen.
 - b. Press the **f2 (done)** key to save the value and exit the number entry screen.
 - c. Press the **f2 (accept)** key to accept the entered cell constant value.
4. Press the **f2 (accept)** key to save and end the calibration and export the data to the calibration log. The meter will automatically proceed to the measurement mode.
5. The conductivity measurement system is now calibrated. Verify the calibration by reading a known conductivity standard or according to your SOP.

Conductivity Standards vs. Temperature Table

Temperature (°C)	Orion 111.9mS Standard (mS/cm)	Orion 12.9mS Standard (mS/cm)	Orion 1413 μ S Standard (μ S/cm)	Orion 147 μ S Standard (μ S/cm)	Orion 100 μ S Standard (μ S/cm)
0	65.10	7.135	776	81	54
1	66.84	7.344	799	83	56
2	68.59	7.555	822	86	58
3	70.35	7.768	846	88	59
4	72.12	7.983	870	91	61
5	73.91	8.200	894	93	63
6	75.70	8.418	918	96	64
7	77.50	8.638	943	98	66
8	79.32	8.860	968	101	68
9	81.15	9.084	992	103	70
10	82.98	9.309	1017	106	72
11	84.83	9.535	1043	108	73
12	86.69	9.763	1068	111	75
13	88.56	9.993	1094	114	77
14	90.45	10.22	1119	116	79
15	92.34	10.46	1145	119	81
16	94.24	10.69	1171	122	83
17	96.15	10.93	1198	125	85
18	98.08	11.16	1224	127	87
19	100.0	11.40	1251	130	88
20	102.0	11.64	1277	133	90
21	103.9	11.88	1304	136	92
22	105.9	12.12	1331	138	94
23	107.9	12.36	1358	141	96
24	109.9	12.61	1386	144	98
25	111.9	12.85	1413	147	100
26	113.9	13.10	1441	150	102
27	115.9	13.35	1468	153	104
28	117.9	13.59	1496	156	106
29	120.0	13.84	1524	159	108
30	122.0	14.09	1552	161	110
31	124.1	14.34	1580	164	112
32	126.2	14.59	1608	167	114
33	128.3	14.85	1636	170	117
34	130.4	15.10	1665	173	119
35	132.5	15.35	1693	176	121
36	134.6	15.61	1722	179	123
37	136.7	15.86	1751	182	125
38	138.9	16.12	1780	185	127
39	141.0	16.37	1808	188	129
40	143.2	16.63	1837	191	131
41	145.4	16.89	1866	194	134
42	147.6	17.15	1896	197	136
43	149.8	17.40	1925	200	138
44	152.0	17.66	1954	203	140
45	154.2	17.92	1983	206	142
46	156.4	18.18	2013	209	145
47	158.7	18.44	2042	212	147
48	160.9	18.70	2071	215	149
49	163.2	18.96	2101	219	151
50	165.4	19.22	2130	222	154

Conductivity Meter Verification Procedure

Use the Orion Star series conductivity meter verification kit, Catalog Number 1010001, to verify the accuracy of the conductivity measurements on Orion Star A322 conductivity meters, Orion Star A325 pH/conductivity meters and Orion Star A329 pH/ISE/conductivity/RDO/DO meters. The measured conductivity value of each resistor should fall within the relative accuracy of the resistor ($\pm 0.1\%$ of the actual resistor conductance) plus the relative accuracy of the meter ($\pm 0.5\%$ of reading ± 1 digit for readings greater than $3 \mu\text{S}/\text{cm}$ or $\pm 0.5\%$ of reading $\pm 0.01 \mu\text{S}/\text{cm}$ for readings less than or equal to $3 \mu\text{S}/\text{cm}$).

1. Ensure that the conductivity resistor kit is certified and has a valid calibration date.
2. In the measurement mode, press the **f1 (cal)** key.
 - a. If more than one channel is displayed in the measurement mode, press the **p** or **q** key to highlight Conductivity-Channel and press the **f2 (select)** key.
3. Press the **f2 (cell K)** key.
4. Press the **f3 (edit)** key to access the popup number entry screen and enter a cell constant value of 1.0000.
 - a. Press the **p**, **q**, **t** or **u** key to highlight a number or decimal point, press the **f3 (enter)** key to select the highlighted item and repeat until the desired value is shown at the top of the screen.
 - b. Press the **f2 (done)** key to save the value and exit the number entry screen.
 - c. Press the **f2 (accept)** key to accept the entered cell constant value.
5. The meter will automatically proceed to the measurement mode and Cell Constant: 1.0000 will be shown on the display.
6. Connect a resistor to the meter, press the **measure (esc)** key to start the measurement, wait for the measurement value to stabilize and then record the displayed conductivity value of the resistor.
7. Repeat step 6 for all six resistors in the kit.

Resistor Number	Nominal Resistance	Nominal Conductance	Nominal Acceptance Range
1010001-A	1000 K Ω	1 μS	0.984 to 1.016 μS
1010001-B	100 K Ω	10 μS	9.930 to 10.07 μS
1010001-C	10 K Ω	100 μS	99.30 to 100.7 μS
1010001-D	1 K Ω	1000 μS	993.0 to 1007 μS
1010001-E	100 Ω	10 mS	9.930 to 10.07 mS
1010001-F	10 Ω	100 mS	99.30 to 100.7 mS

Note: These are the nominal values for the resistors only. The actual resistance and conductance is printed on each resistor and the actual acceptance range must be calculated from the actual value on each resistor.

Measurement Procedure

Prepare the sensors according to the instructions in the sensors manuals. Connect all electrodes, sensors and probes to be used to the appropriate meter inputs. Make sure the sensors are recently calibrated and working correctly.

Ensure the meter measurement mode is set to the desired measurement parameter. For Star A325 meters and Star A329 meters, press the **f3 (channel)** key until the desired channel or channels are shown in the measurement mode.

1. Rinse the sensors with distilled water or appropriate solution, blot gently with a lint-free tissue to remove excess water and place into the sample.
2. Start the measurement and wait for the reading to stabilize or reach the predefined time.
 - a. Auto-Read: Press the **measure (esc)** key to start the measurement.
 - b. Continuous: Measurements will start immediately when in the measurement mode.
 - c. Timed: Measurements will start immediately when in the measurement mode.
3. Once the measurement is stable or reaches the set time, record all applicable parameters.
 - a. Auto-Read: Once the measurement is stable, it will be locked and held on the display and the **AR** icon will remain solid. If the data log function is enabled, the measurement will be exported to the data log.
 - b. Continuous: The flashing **Stabilizing** icon will update to the solid **Ready** icon when the measurement is stable. If the data log function is enabled, press the **log/print** key to export the measurement to the data log.
 - c. Timed: Measurements will be recorded at the predefined time interval. If the data log function is enabled, the **<** icon will be shown when each time interval has elapsed and the measurement is exported to the data log.
4. Remove the sensors from the sample, rinse with distilled water or appropriate solution, blot gently with a lint-free tissue to remove excess water and place into the next sample.
5. Repeat steps 2 through 4 for all samples. When all samples have been measured, store the sensors according to the instructions in the sensor manuals.

6

CHAPTER 6 Using the DO/RDO Channel

Use the Orion Star A323 RDO/DO meter, Orion Star A326 pH/RDO/DO meter or Orion Star A329 pH/ISE/conductivity/RDO/DO meter to measure dissolved oxygen as percent saturation or mg/L and temperature using either Orion RDO optical or polarographic dissolved oxygen sensors. The following chapter provides instructions on connecting sensors, calibrating the system and measuring these parameters.

Meter and Sensor Preparation

1. Familiarize yourself with general meter operation and prepare the meter and accessories according to the instructions in [Chapter 2 Meter Basics](#).
2. Refer to the instructions in [Chapter 3 Meter Setup Menus](#) to customize measurement, calibration and alarm settings within the DO/RDO Channel setup menu and data transfer, data log, date and time, language, sounds, display contrast, auto-shutoff, user ID and sample ID settings within the Instrument Settings setup menu.
3. Connect all necessary electrodes, probes and sensors to the appropriate meter inputs.
 - a. Connect an RDO optical or polarographic dissolved oxygen sensor to the 9 pin MiniDIN meter input. The meter will automatically detect which dissolved oxygen sensor is connected. The temperature will also be measured when the dissolved oxygen sensor is connected with the meter.
4. Prepare all connected sensors for use as instructed in the sensor manuals.

Dissolved Oxygen Calibration Procedure

Note: A polarographic dissolved oxygen sensor must be polarized prior to use. The polarographic dissolved oxygen sensor is continuously polarized when connected to the meter. If the polarographic dissolved oxygen sensor is new, has been serviced or has not been connected to the meter – connect the sensor to the meter, power on the meter and wait 30 minutes for the sensor to polarize.

Orion Star A323 RDO/DO meters, Orion Star A326 pH/RDO/DO meters and Orion Star A329 pH/ISE/conductivity/RDO/DO meters can perform the following calibrations:

- Air (water-saturated air) – This is the simplest and most accurate method and uses the calibration sleeve included with most dissolved oxygen sensors. For best accuracy, the calibration temperature should match the expected sample temperature. Moisten the sponge in the calibration sleeve with distilled water and insert the sensor into the sleeve. Alternatively, a BOD bottle can be used with just enough distilled water to cover the bottom without touching the sensor.
- Water (air-saturated water) – This method uses water that is 100% saturated with air. Bubble air into a water sample for an extended period, preferably overnight.
- Manual (Winkler) – This method uses a water sample with a known concentration of dissolved oxygen and is typically used to calibrate the DO sensor to the value achieved by a Winkler titration. Due to possible titration errors, this method is inherently less accurate.
- Set Zero – This method uses an oxygen free solution to add a zero point to an existing Water Saturated Air or Air Saturated Water calibration. This calibration is generally recommended when measurements are below 10% saturation or 1 mg/L.

Prepare the dissolved oxygen sensor according to the instructions in the sensor manual. Connect all sensors to be used to the appropriate meter inputs.

Make sure the meter measurement mode is set to dissolved oxygen (DO or RDO). For Star A326 meters and Star A329 meters, press the **f3 (channel)** key until the dissolved oxygen channel is shown in the measurement mode.

Air (Water-saturated Air) Calibration

1. Press the **f1 (cal)** key to start the calibration.
 - a. If more than one channel is displayed in the measurement mode, press the **␣** or **␣** key to highlight DO/RDO-Channel and press the **f2 (select)** key.
2. Press the **␣** or **␣** key to highlight Air and press the **f3 (select)** key.
3. Prepare the DO sensor and calibration sleeve and allow them to reach equilibrium.
4. When the DO sensor and calibration sleeve are ready, press the **f3 (start)** key.
5. Wait for the dissolved oxygen value on the meter to stabilize.
 - a. With a polarographic DO sensor, 102.3% will be displayed when the reading stabilizes.
 - b. With an RDO optical DO sensor, 100.0% will be displayed when the reading stabilizes.
6. Press the **f2 (cal done)** key to save and end the calibration.
7. The meter will display the calibration summary and export the data to the calibration log. Press the **f1 (meas)** key to proceed to the measurement mode or press the **f2 (print)** key to export the calibration data to a printer or computer.

Water (Air-saturated Water) Calibration

1. Press the **f1 (cal)** key to start the calibration.
 - a. If more than one channel is displayed in the measurement mode, press the **␣** or **␣** key to highlight DO/RDO-Channel and press the **f2 (select)** key.
2. Press the **␣** or **␣** key to highlight Water and press the **f3 (select)** key.
3. Prepare the DO sensor and 100% air-saturated water and allow them to reach equilibrium.
 - a. Use plastic paraffin film to seal the open area between the DO sensor and vessel containing the 100% air-saturated water.
4. When the DO sensor and calibration apparatus are ready, press the **f3 (start)** key.
5. Wait for the dissolved oxygen value on the meter to stabilize.
 - a. 100.0% will be displayed when the reading stabilizes.
6. Press the **f2 (cal done)** key to save and end the calibration.
7. The meter will display the calibration summary and export the data to the calibration log. Press the **f1 (meas)** key to proceed to the measurement mode or press the **f2 (print)** key to export the calibration data to a printer or computer.

Manual (Winkler) Calibration

1. Press the **f1 (cal)** key to start the calibration.
 - a. If more than one channel is displayed in the measurement mode, press the **p** or **q** key to highlight DO/RDO-Channel and press the **f2 (select)** key.
2. Press the **p** or **q** key to highlight Manual and press the **f3 (select)** key.
3. Prepare the DO sensor and calibration solution and allow them to reach equilibrium.
 - a. Use plastic paraffin film to seal the open area between the DO sensor and vessel containing the calibration solution.
4. When the DO sensor and calibration apparatus are ready, press the **f3 (start)** key.
5. Wait for the dissolved oxygen value on the meter to stabilize and perform one of the following actions:
 - a. Press the **f2 (accept)** key to accept the displayed dissolved oxygen value.
Or
 - b. Press the **f3 (edit)** key to access the popup number entry screen and manually enter the dissolved oxygen value.
 - i. Press the **p**, **q**, **t** or **u** key to highlight a number or decimal point, press the **f3 (enter)** key to select the highlighted item and repeat until the desired value is shown at the top of the screen.
 - ii. Press the **f2 (done)** key to save the value and exit the number entry screen.
6. Press the **f2 (cal done)** key to save and end the calibration.
7. The meter will display the calibration summary and export the data to the calibration log. Press the **f1 (meas)** key to proceed to the measurement mode or press the **f2 (print)** key to export the calibration data to a printer or computer.

Set Zero Calibration

An Air (water-saturated air) calibration or Water (air-saturated water) calibration must be completed before a Set Zero calibration can be performed.

Prepare a sodium sulfite solution by dissolving about 15.0 grams of Na_2SO_3 in about 250 mL of distilled water. Transfer the solution to a BOD bottle or flask and use plastic paraffin film to seal the bottle. A small amount of cobalt salt can be added to the sodium sulfite solution to act as an indicator and change color when the sodium sulfite solution no longer has zero oxygen content.

1. Press the **f1 (cal)** key to start the calibration.
 - a. If more than one channel is displayed in the measurement mode, press the **p** or **q** key to highlight DO/RDO-Channel and press the **f2 (select)** key.
2. Press the **p** or **q** key to highlight Set Zero and press the **f3 (select)** key.
3. Prepare the DO sensor and zero oxygen solution and allow them to reach equilibrium.
 - a. Use plastic paraffin film to seal the open area between the DO sensor and vessel containing the calibration solution.
4. When the DO sensor and calibration apparatus are ready, press the **f3 (start)** key.
5. Wait for the dissolved oxygen value on the meter to stabilize.
 - a. 0.0% will be displayed for P2 when the reading stabilizes.
6. Press the **f2 (cal done)** key to save and end the calibration.
7. The meter will display the calibration summary and export the data to the calibration log. Press the **f1 (meas)** key to proceed to the measurement mode or press the **f2 (print)** key to export the calibration data to a printer or computer.

Measurement Procedure

Prepare the sensors according to the instructions in the sensors manuals. Connect all electrodes, sensors and probes to be used to the appropriate meter inputs. Make sure the sensors are recently calibrated and working correctly.

Ensure the meter measurement mode is set to the desired measurement parameter. For Star A326 meters and Star A329 meters, press the **f3 (channel)** key until the desired channel or channels are shown in the measurement mode.

1. Rinse the sensors with distilled water or appropriate solution, blot gently with a lint-free tissue to remove excess water and place into the sample.
2. Start the measurement and wait for the reading to stabilize or reach the predefined time.
 - a. Auto-Read: Press the **measure (esc)** key to start the measurement.
 - b. Continuous: Measurements will start immediately when in the measurement mode.
 - c. Timed: Measurements will start immediately when in the measurement mode.
3. Once the measurement is stable or reaches the set time, record all applicable parameters.
 - a. Auto-Read: Once the measurement is stable, it will be locked and held on the display and the **AR** icon will remain solid. If the data log function is enabled, the measurement will be exported to the data log.
 - b. Continuous: The flashing **Stabilizing** icon will update to the solid **Ready** icon when the measurement is stable. If the data log function is enabled, press the **log/print** key to export the measurement to the data log.
 - c. Timed: Measurements will be recorded at the predefined time interval. If the data log function is enabled, the **<** icon will be shown when each time interval has elapsed and the measurement is exported to the data log.
4. Remove the sensors from the sample, rinse with distilled water or appropriate solution, blot gently with a lint-free tissue to remove excess water and place into the next sample.
5. Repeat steps 2 through 4 for all samples. When all samples have been measured, store the sensors according to the instructions in the sensor manuals.

7

CHAPTER 7 Data Transfer and Software Updates

Data Storage and Transfer Settings

Meter settings that affect data storage and transfer include the measurement read type, export data settings and data log setting. The date and time settings should also be reviewed and update as needed.

Measurement Read Type Setting

The selected read type determines when the meter sends measurements to the data log, if the data log is enabled in the setup menu, and when the meter exports measurements to a printer or computer, if a printer or computer is properly connected to the meter and export data settings are enabled in the setup menu. Select from Auto-Read, continuous and timed read types.

Auto-Read

Press the **measure (esc)** key to start a measurement. The **AR** icon blinks as the changing value stabilizes. When the measurement is stable, the **AR** icon stops blinking and the measurement is locked on the display until the **measure (esc)** key is pressed again. When the data log and export data settings are enabled, the stable measurement is automatically saved to the data log and exported to a printer or computer.

Continuous

Measurement values are continuously updated on the display and the **Stabilizing** or **Ready** icon indicates the measurement stability status. When the data log and export data settings are enabled, press the **log/print** key to save a measurement to the data log and export it to a printer or computer.

Timed

Measurement values are continuously updated on the display and the *Stabilizing* or *Ready* icon indicates the measurement stability status. When the data log and export data settings are enabled, measurements are saved to the data log and exported to a printer or computer at the selected time intervals from 3 seconds (00:00:03) to 24 hours (24:00:00).

To Set Measurement Read Type:

1. In the measurement mode, press the **setup** key to access the main setup menu.
2. Press the **p**, **q**, **t** or **u** key to highlight pH Channel, pH/ISE Channel, COND Channel or DO/RDO Channel and press the **f3 (select)** key.
3. Press the **p** or **q** key to highlight Mode and Settings and press the **f3 (select)** key.
4. Press the **p** or **q** key to highlight Read Type and press the **f3 (select)** key.
5. Press the **p** or **q** key to highlight Auto, Continuous or Timed and press the **f3 (select)** key to set the desired measurement mode.
 - a. If Timed is selected, press the **t** or **u** key to highlight the hours (00:00:00), minutes (00:00:00) or seconds (00:00:00).
 - b. Press the **f3 (edit)** key to access the popup number entry screen.
 - c. Press the **p**, **q**, **t** or **u** key to highlight a number, press the **f3 (enter)** key to select the number and repeat until a two digit value is shown at the top of the screen.
 - d. Press the **f2 (done)** key to save the value and exit the number entry screen.
 - e. Repeat until the correct time interval is entered for the hours, minutes and seconds.
Time intervals from 3 seconds (00:00:03) to 24 hours (24:00:00) can be entered.
6. Press the **f1 (back)** key to navigate out of the menu and then press the **measure (esc)** key to return to the measurement mode.

Data Log Setting

To save up to 5000 measurement sets to the meter data log, turn the data log setting on in the setup menu.

1. In the measurement mode, press the **setup** key to access the main setup menu.
2. Press the **p**, **q**, **t** or **u** key to highlight Settings and press the **f3 (select)** key.
3. Press the **p** or **q** key to highlight Data Log and press the **f3 (select)** key.
4. Press the **p** or **q** key to highlight On and press the **f3 (select)** key.
5. Press the **f1 (back)** key to navigate out of the menu and press the **measure (esc)** key to return to the measurement mode.

Export Data Settings

To transfer measurements to a computer or printer, turn the export data function on in the setup menu and update export settings to match the external device settings, including the baud rate. The default meter communication connection is RS232 and the meter will automatically detect and adjust the connection setting when an active USB cable is connected with the meter.

1. In the measurement mode, press the **setup** key to access the main setup menu.
2. Press the **p**, **q**, **t** or **u** key to highlight **Settings** and press the **f3 (select)** key.
3. Press the **p** or **q** key to highlight **Export Data** and press the **f3 (select)** key.
4. Press the **p** or **q** key to highlight **Printing** and press the **f3 (select)** key. Press the **p** or **q** key to highlight **On** and press the **f3 (select)** key.
5. Press the **p** or **q** key to highlight **Data Format** and press the **f3 (select)** key. Press the **p** or **q** key to highlight **Printer** or **PC (CSV)** and press the **f3 (select)** key.
6. Press the **p** or **q** key to highlight **Comm Config** and press the **f3 (select)** key. Press the **p** or **q** key to highlight **1200**, **2400**, **4800**, **9600**, **19200** or **38400** as the meter baud rate and press the **f3 (select)** key.
7. Press the **f1 (back)** key to navigate out of the menu and press the **measure (esc)** key to return to the measurement mode.

Data Transfer Examples

5 Point pH Calibration, CSV Format, HyperTerminal View:

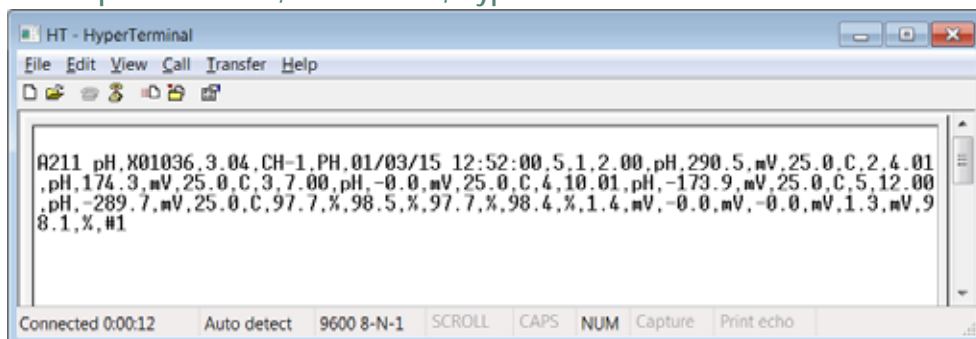

pH Measurement, CSV Format, HyperTerminal View:

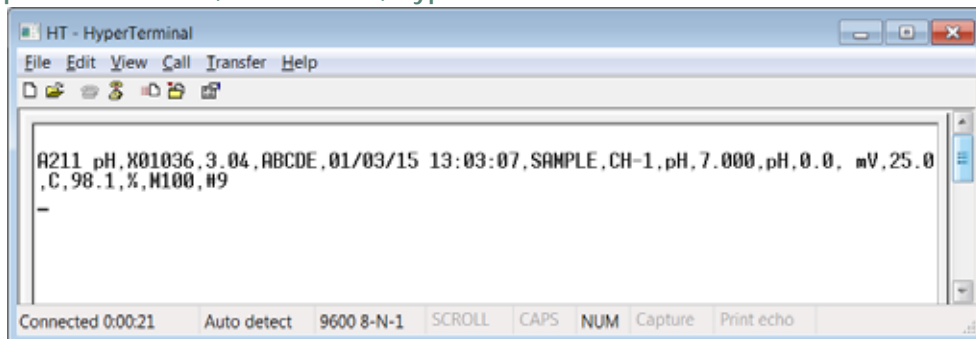

5 Point pH Calibration, Printer Format:

```

-----
Thermo Scientific (c) 2011
A211 pH
Meter S/N           X01036
SW Rev             3.04
--Calibration Report--
PH
12/27/14 16:43:00
Point 1
pH                 2.00 pH
mV                 290.5 mV
Temperature        25.0 C
Point 2
pH                 4.01 pH
mV                 174.3 mV
Temperature        25.0 C
Point 3
pH                 7.00 pH
mV                 0.0 mV
Temperature        25.0 C
Point 4
pH                 10.01 pH
mV                 -173.6 mV
Temperature        25.0 C
Point 5
pH                 12.00 pH
mV                 -289.4 mV
Temperature        25.0 C
Slope1             97.7 %
Slope2             98.5 %
Slope3             97.5 %
Slope4             98.4 %
E1                 1.5 mV
E2                 0.0 mV
E3                 0.0 mV
E4                 1.7 mV

Average Slope      98.0 %
Calibration        #3

Operator
Signature _____

```

pH Measurement, Printer Format:

```

-----
Thermo Scientific (c) 2011
A211 pH
Meter S/N           X01036
SW Rev             3.04
User ID  ABCDE
01/03/15 12:58:34
SampleID  SAMPLE

pH                 7.000 pH
mV                 0.0 mV
Temperature        25.0 C
Slope              98.1 %
Method#            M100
Calibration        #1

Operator _____
Signature _____

```

Printer Compatibility and Requirements

Orion Star A320 series portable meters can print directly to the Orion Star series inkjet printer, Catalog Number 1010006. Measurement and calibration data sent from the meter to the Orion Star series inkjet printer is automatically formatted to fit the paper width when the printer data format is selected within the Export Data setting. The Orion Star series inkjet printer has a 9600 baud rate and it is packaged with the RS232 printer cable required to interface an Orion Star A320 series meter to this printer.



The baud rate of Orion Star A320 series meters can be set to 1200, 2400, 4800, 9600, 19200 or 38400 for communication to different printers. The fixed meter settings are:

Number of Data Bits:	8
Stop Bits:	1
Parity:	None
Flow Control:	XON/XOFF

The meter will send measurements and calibration data to the printer if the printer option is turned on in the setup menu. Alternatively, measurements and calibration data can be sent to the data log and calibration log. From the data log and calibration log, the operator can choose to print a single data log point, a range of data log points or the entire data log.

Computer Compatibility and Requirements

The Orion Star A320 series meters can send measurements and calibration data to a computer in a comma delimited format that is easy to parse in computer programs like Excel.

The baud rate of Orion Star A320 series meters can be set to 1200, 2400, 4800, 9600, 19200 or 38400. The fixed meter settings are:

Number of Data Bits:	8
Stop Bits:	1
Parity:	None
Flow Control:	XON/XOFF

The meter will send measurements and calibration data to the computer if the printer option is turned on in the setup menu. Alternatively, measurements and calibration data can be sent to the data log and calibration log. From the data log and calibration log, the operator can chose to print a single data log point, a range of data log points or the entire data log.

The computer must be up-to-date with the latest Windows updates installed and have .NET framework version 4.0 with the latest updates.

All computer screen savers and power management settings should be disabled when the meter is interfaced with the computer. The computer should not go into sleep/standby mode while the meter is transferring data. Laptop computers should be plugged into a power supply, running on battery power is not recommended.

Three computer cables can be used to interface the Orion Star A320 series portable meters with a computer – the Orion Star series USB-to-Serial computer cable (Cat. No. 1010005), Orion Star series RS232 computer cable (Cat. No. 1010053) or a standard Mini B USB to USB computer cable.

Computer Cable	Meter Connection	Computer Connection	Driver Required
USB-to-Serial Computer Cable, Cat. No. 1010005	RS232	USB	Yes
RS232 Computer Cable, Cat. No. 1010053	RS232	RS232	No
USB Computer Cable (standard Mini B USB to USB cable)	USB (Mini B)	USB	Yes

Using the USB-to-Serial Computer Cable

Turn on the power to the meter and connect the USB-to-Serial computer cable first to the meter and then to the computer. The USB-to-Serial driver must be installed when the meter will be interfaced with a computer using the USB-to-Serial computer cable. The USB-to-Serial driver is compatible with Microsoft® Windows® XP, Windows Vista®, Windows 7 and Windows 8 operating systems.

1. Connect the meter to a wall outlet using the universal power adapter (catalog number 1010003) or install four AA batteries and power on the meter.
2. Connect the USB-to-Serial computer cable first to the meter's RS232 input and then to the computer's USB input.
3. After the USB-to-Serial computer cable is connected to the computer, the computer will automatically identify the device and install the driver. Once the device driver is done installing, the USB-to-Serial computer cable can be used to transfer data from the meter to the computer using Orion Star Com computer software, HyperTerminal or similar program and send remote commands from the computer to the meter.

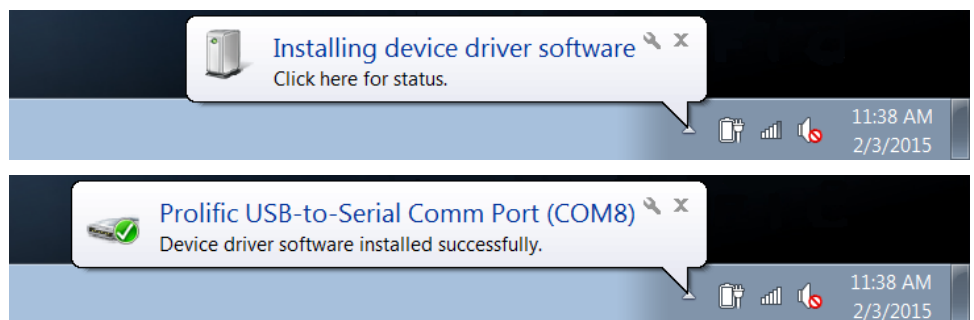

4. Record the COM port location of the USB-to-Serial cable, for example COM8. To view the COM port location, open the computer's Device Manager tool and expand the Ports option.
 - a. For Windows 7: Click the Start button and then click Control Panel. In the Control Panel window, click Device Manager if viewing by large icons or small icons or click System and Security and then click Device Manager if viewing by category. In the Device Manager window, expand the Ports option.
 - b. For Windows XP: Click the Start button and then click Control Panel. In the Control Panel window, click the Performance and Maintenance link and then click the System icon or for Control Panel Classic View, just double-click the System icon. In the System Properties window, click the Hardware tab and then click the Device Manager button. In the Device Manager window, expand the Ports option.

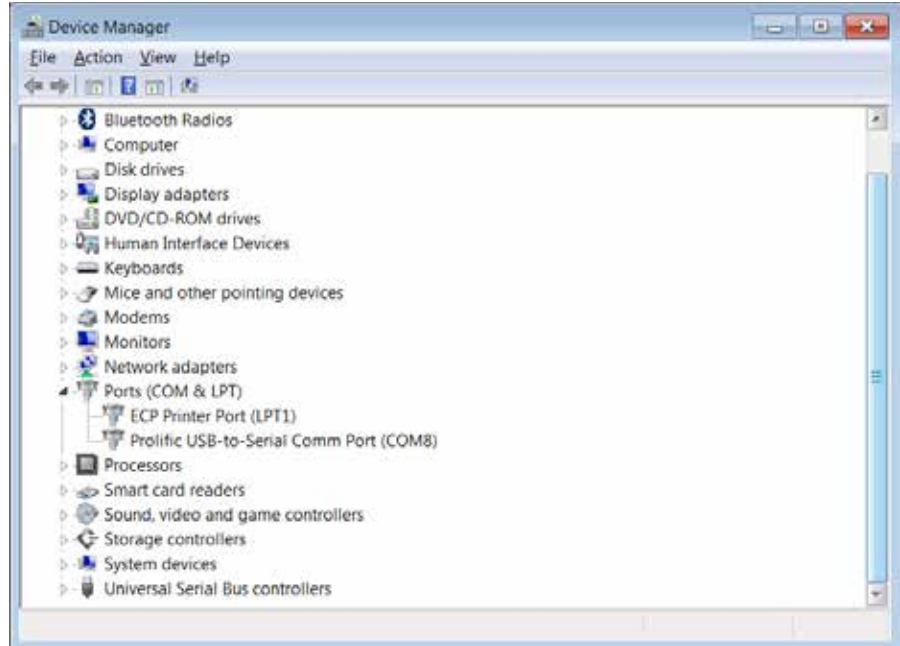

- The meter is now able to transfer data to the computer using the Virtual COM port and Orion Star Com computer software, HyperTerminal or similar program.

Note: If the computer does not automatically install the device driver, open the computer's Device Manager tool, expand the Other Devices option, double click the device and manually install the driver. The drivers for some RS232 to USB to adapters may need to be downloaded from the manufacturer's website. For example, when using a Tripp Lite adapter, go to <http://www.tripplite.com/support/downloads/>, enter the model number of the adapter (i.e. U209-000-R) and select the appropriate driver for the computer operating system.

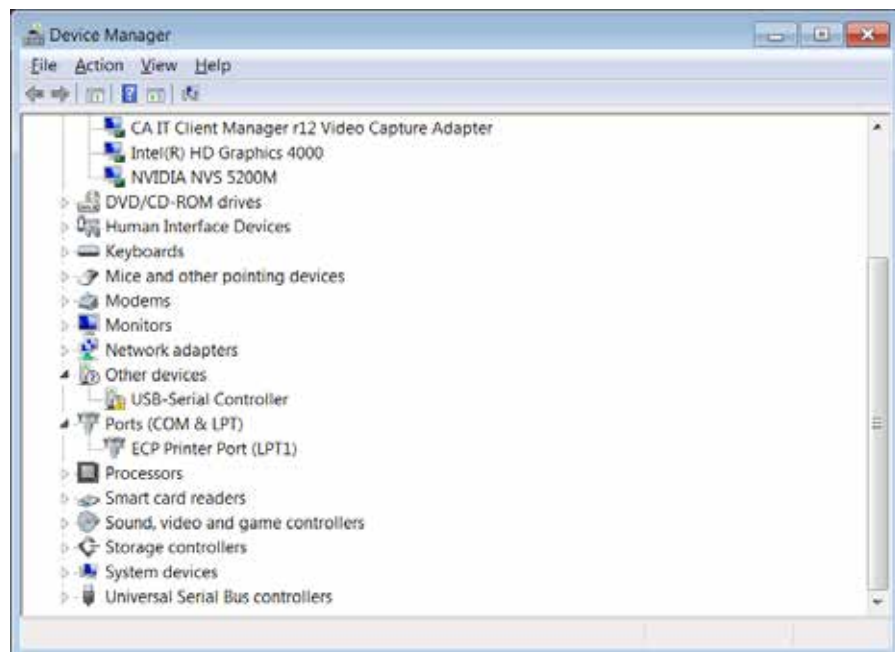

Using the USB Computer Cable

The Orion Star A200-A300 USB driver must be installed when the meter will be interfaced with a computer using the USB computer cable. The Orion Star A200-A300 USB driver is compatible with Microsoft® Windows® XP, Windows Vista®, Windows 7 and Windows 8 operating systems. When using a USB computer cable, always turn on the power to the meter and connect the USB computer cable first to the meter and then to the computer.

1. Go to www.thermoscientific.com/OrionMeters, download the Orion Star A200-A300 USB driver folder and unzip/extract the files to the computer's desktop.
2. Connect the power adapter to the meter and power on the meter.
3. Connect the USB cable first to the Mini B USB input on the meter and then to the USB input on a computer.
4. Once the USB cable is connected to the computer, the computer will try to search for the device driver software and then a message will appear that the device driver software was not successfully installed. Open the computer's Device Manager tool.
 - a. For Windows 7: Click the Start button and then click Control Panel. In the Control Panel window, click Device Manager if viewing by large icons or small icons or click System and Security and then click Device Manager if viewing by category. In the Device Manager window, expand the Ports option.
 - b. For Windows XP: Click the Start button and then click Control Panel. In the Control Panel window, click the Performance and Maintenance link and then click the System icon or for Control Panel Classic View, just double-click the System icon. In the System Properties window, click the Hardware tab and then click the Device Manager button. In the Device Manager window, expand the Ports option.
5. Locate and double-click on the Virtual COM Port (CDC) device in the Device Manager tool.

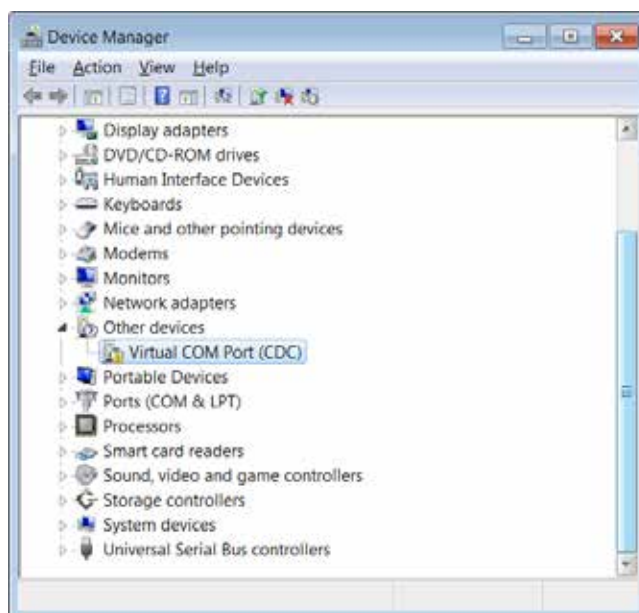

6. The Virtual COM Port (CDC) properties window will open. Click the Update Driver button.

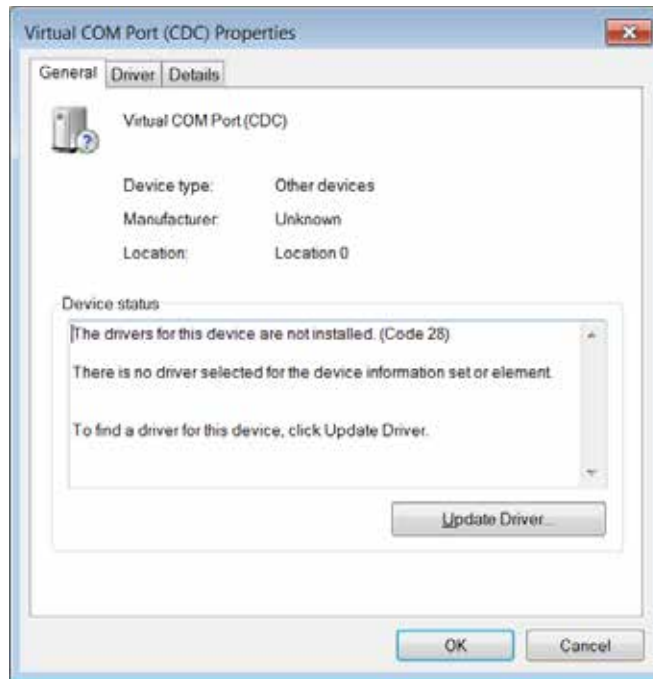

7. Click the "Browse my computer for driver software" option.

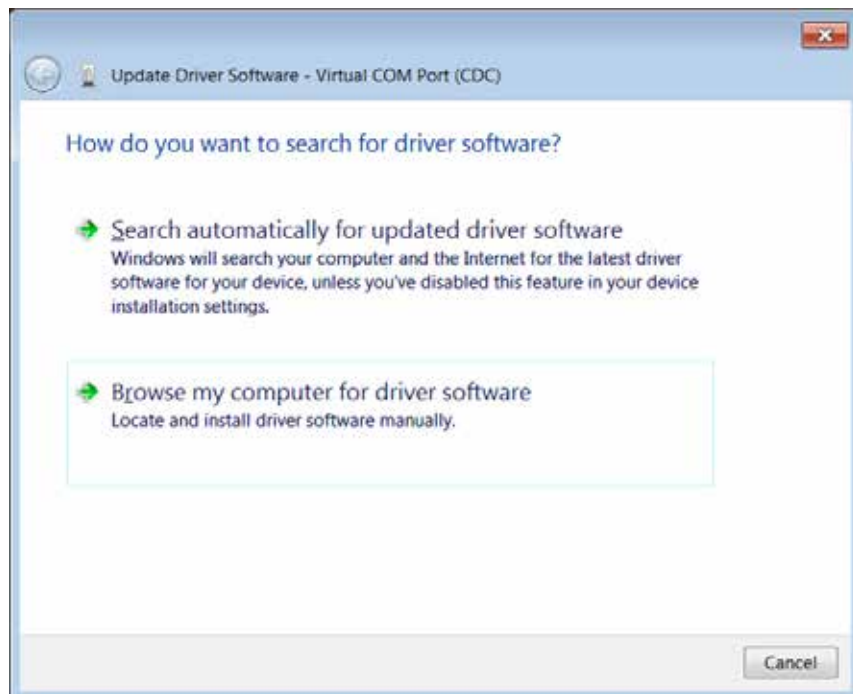

8. Click the Browse button, set the computer desktop as the location and click the Next button.

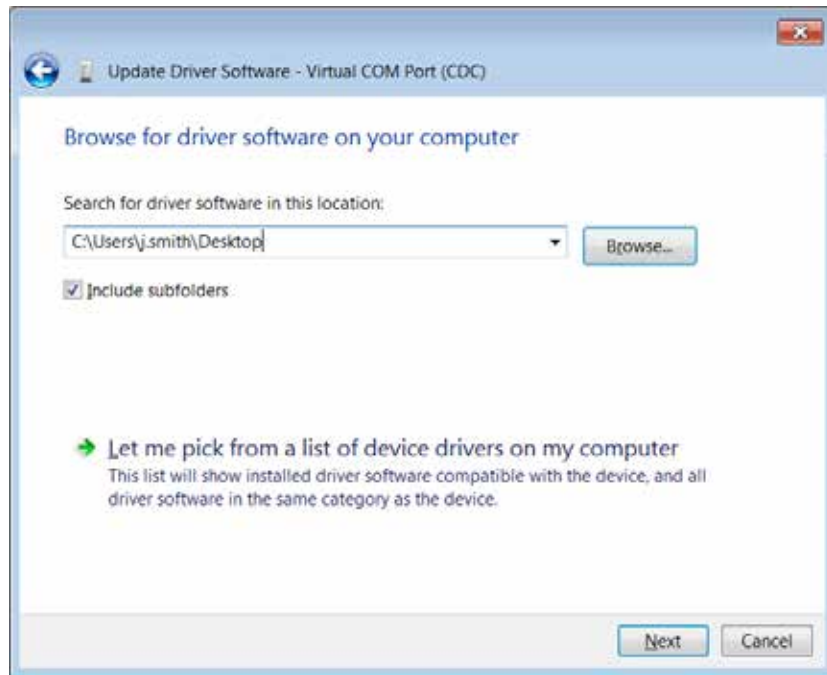

9. Wait while the driver software is installed and accept any warning messages.
10. Once the installation is complete, record the COM port location and click the Close button.

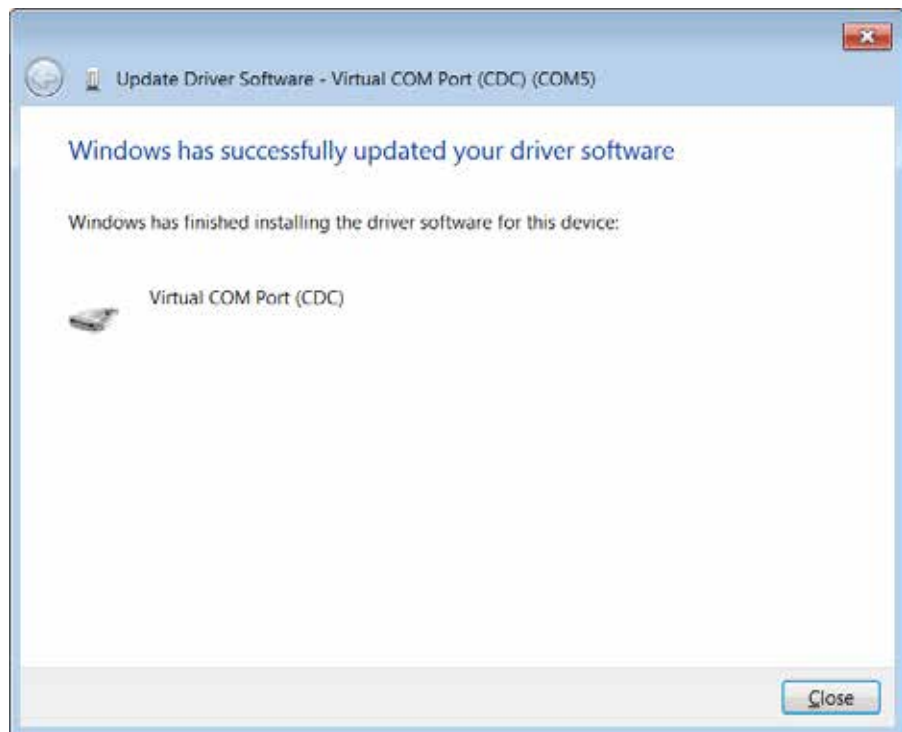

11. The meter is now able to transfer data to the computer using the Virtual COM port and Orion Star Com computer software, HyperTerminal or similar program.

Meter Interfacing with Other Computer Programs

If using the meter USB port to connect with the computer, the Orion Star A200/A300 series USB driver software (virtual COM port) must be installed on the computer and the meter should be updated to software revision 3.04 or higher.

1. Power on the meter and connect the meter to the computer using the appropriate computer interface cable.
2. Open a computer communication program that uses COM ports. Programs such as Terminal and HyperTerminal apply.
3. Select the correct Virtual COM Port and connect. The following examples are from HyperTerminal:

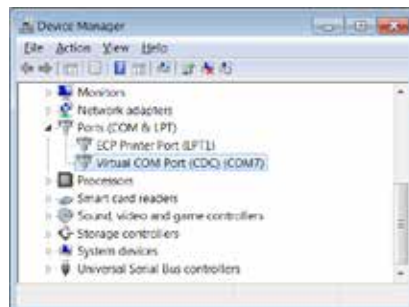

4. Verify that the meter export data setting is on. Match the baud rate set in the meter to the computer setting. Selecting a higher baud rate will allow for faster data transfer.
5. Data will transfer from the meter to the computer, depending on the meter read type and command settings.

Note: If the meter is powered off for any reason (auto-shut off, loss of power, etc.) the connection will need to be reestablished by repeating the steps above.

Star A200-A300 Meter Remote Control Protocols

Rules for Remote Control Usage

1. CR (Carriage Return, ASCII 13) is used to terminate a command. Whenever this character is received, the internal buffer will be processed.
2. All characters except for NL (New Line, ASCII 10) are significant. The NL character will be ignored. The meter is not case sensitive, though all lower case characters are converted to upper case internally.
3. Only one command can be executed at a time. No new command can issued until the current command is finished being processed. When the current command is finished, it will issue the ">" prompt to the user, indicating a new command can be entered.
4. Empty commands (i.e. just a CR) will be ignored and a new prompt will be issued.
5. Turn on the Export Data and Data Log meter settings. The default meter communication settings are:

Bits per second:	9600
Data bits:	8
Parity:	None
Stop bits:	1
Flow control:	None

Remote Control Engine

The remote control engine receives input from the serial/USB port and processes it as needed. Commands sent to the remote control interface will be in the form of "OPCODE <OPERAND(s)> C_R ". Line feeds will be ignored. New commands cannot be issued until the previous command has been completed and a prompt is given. A prompt is shown as the greater than symbol (">") followed by a space.

Star A200-A300 Meter Remote Control Commands

Press the Esc key on the computer keypad to stop a command being executed.

Command	Command Details												
GETMEAS	<p>GETMEAS <CR> Prints the current channel measurement immediately.</p> <p>GETMEAS <u>Data Count</u> <CR> Prints the current channel measurement for a set number of times. Example: GETMEAS 2</p> <p>GETMEASTIMED CH_Channel Combination, Time Interval <CR> Set the channel(s) to be measured and the time interval for the measurement, measurements are sent to the meter data log Channel Combination: Channel numbers to be measured. Time Interval: The measurement retrieving time interval in seconds. Example: GETMEASTIMED CH_12 5 <CR></p> <p>STOP <CR> Command exits Timed measurement.</p>												
GETCAL	<p>GETCAL MODE <CR> Prints all the channel mode calibration data. If no calibration is available, will return ">" to receive next command. Example: GETCAL MODE <CR></p> <p>GETCAL <u>MODE</u> <CR> Print calibration data for specific <u>MODE</u> as:</p> <table border="0"> <tr> <td>PH</td> <td>COND</td> <td>DO</td> </tr> <tr> <td>RMV</td> <td>RES</td> <td>RDO</td> </tr> <tr> <td>ORP</td> <td>SALT</td> <td></td> </tr> <tr> <td>ISE</td> <td>TDS</td> <td></td> </tr> </table> <p>Example: GETCAL PH <CR></p>	PH	COND	DO	RMV	RES	RDO	ORP	SALT		ISE	TDS	
PH	COND	DO											
RMV	RES	RDO											
ORP	SALT												
ISE	TDS												
GETLOG	<p>GETLOG <CR> Prints all the logged measurement data. If no data is logged, will return ">" to receive next command. Example: GETLOG <CR></p> <p>GETLOG START, END <CR> Prints the data in a specified range. If no data is available, will return ">" to receive next command. Example: GETLOG 10 100 <CR></p>												
SYSTEM	<p>SYSTEM <CR> Prints the Meter Model, Serial Number, Software Version Example: 329, 12345, 2.53</p>												
SETRTC	<p>SETRTC <u>YY MM DD HH MM SS</u> <CR> Set the date and time (in 24 hour format) for the meter Example: SETRTC 13 07 15 08 30 00</p>												

Command	Command Details												
SETMODE	<p>SETMODE <u>MODE</u> <CR></p> <p>Set the current channel measurement <u>MODE</u> as:</p> <table> <tr> <td>PH</td> <td>COND</td> <td>DOSAT</td> </tr> <tr> <td>RMV</td> <td>RES</td> <td>DOCON</td> </tr> <tr> <td>ORP</td> <td>SALT</td> <td></td> </tr> <tr> <td>ISE</td> <td>TDS</td> <td></td> </tr> </table> <p>Example: SETMODE PH <CR></p>	PH	COND	DOSAT	RMV	RES	DOCON	ORP	SALT		ISE	TDS	
PH	COND	DOSAT											
RMV	RES	DOCON											
ORP	SALT												
ISE	TDS												
GETMODE	<p>GETMODE <u>CHANNEL</u> <CR></p> <p>Print the channel measurement mode</p> <p>Example: GETMODE 1</p>												
SETCSV	<p>SETCSV <CR></p> <p>Set printing format to CSV</p>												
SETKEYLOCK	<p>SETKEYLOCK <u>NUMBER</u> <CR></p> <p>To disable the key pad: Number = 0</p> <p>To enable the key pad Number = 1</p>												

Meter Measurement Data from GETMEAS Command

Measure Mode	PC (CSV) Format
pH	<p>Meter Model, Serial Number, Software Revision, User ID, Date & Time, Sample ID, Channel, Mode, pH Value, pH Unit, mV Value, mV Unit, Temperature Value, Temperature Unit, Slope Value, Slope Unit, Method #, Log #</p> <p>Example: A211 pH, X01036, 3.04, ABCDE, 01/03/15 16:05:41, SAMPLE, CH-1, pH, 7.000, pH, 0.0, mV, 25.0, C, 98.1,%, M100, #1 <CR></p>
mV	<p>Meter Model, Serial Number, Software Revision, User ID, Date & Time, Sample ID, Channel, Mode, mV Value, mV Unit, Temperature Value, Temperature Unit, Method #, Log #</p> <p>Example: A211 pH, X01036, 3.04, ABCDE, 01/03/15 16:05:41, SAMPLE, CH-1, mV, 0.0, mV, 25.0, C, M100, #2 <CR></p>
RmV	<p>Meter Model, Serial Number, Software Revision, User ID, Date & Time, Sample ID, Channel, Mode, Relative mV Value, Relative mV Unit, Offset mV Value, Offset mV Unit, Temperature Value, Temperature Unit, Method #, Log #</p> <p>Example: A211 pH, X01036, 3.04, ABCDE, 01/03/15 16:05:41, SAMPLE, CH-1, RmV, 0.0, RmV, 0.0, mV, 25.0, C, M100, #3 <CR></p>
ORP	<p>Meter Model, Serial Number, Software Revision, User ID, Date & Time, Sample ID, Channel, Mode, ORP Value, ORP Unit, mV Value, mV Unit, Temperature Value, Temperature Unit, Method #, Log #</p> <p>Example: A211 pH, X01036, 3.04, ABCDE, 01/03/15 16:05:41, SAMPLE, CH-1, ORP, 0.0, mV, 0.0, mV, 25.0, C, M100, #4 <CR></p>

Measure Mode	PC (CSV) Format
ISE	<p>Meter Model, Serial Number, Software Revision, User ID, Date & Time, Sample ID, Channel, Mode, ISE Value, ISE Unit, mV Value, mV Unit, Temperature Value, Temperature Unit, Slope Value, Slope Unit, Method #, Log #</p> <p>Example: A214 pH/ISE, X01037, 3.04, ABCDE, 01/03/15 16:05:41, SAMPLE, CH-1, ISE, 1, ppb, 0.0, mV, 25.0, C, 59.2, mV/dec, M100, #1 <CR></p>
Conductivity	<p>Meter Model, Serial Number, Software Revision, User ID, Date & Time, Sample ID, Channel, Mode, Conductivity Value, Conductivity Unit, Conductance Value, Conductance Unit, Temperature Value, Temperature Unit, Temperature Coefficient Value, Temperature Coefficient Unit, Reference Temperature Value, Reference Temperature Unit, Cell Constant Value, Cell Constant Unit, Method #, Log #</p> <p>Example: A212 Cond, X01038, 3.04, ABCDE, 01/03/15 16:05:41, SAMPLE, CH-1, COND, 936.41, uS/cm, 1977.59, uS, 25.0, C, 2.1, %/C, 25.0, C, 0.4750, /cm, M100, #1 <CR></p>
TDS	<p>Meter Model, Serial Number, Software Revision, User ID, Date & Time, Sample ID, Channel, Mode, TDS Value, TDS Unit, Conductance Value, Conductance Unit, Temperature Value, Temperature Unit, Temperature Coefficient Value, Temperature Coefficient Unit, Reference Temperature Value, Reference Temperature Unit, Cell Constant Value, Cell Constant Unit, Method #, Log #</p> <p>Example: A212 Cond, X01038, 3.04, ABCDE, 01/03/15 16:05:41, SAMPLE, CH-1, TDS, 460, ppm, 1975, uS, 25.0, C, 2.1, %/C, 25.0, C, 0.4750, /cm, M100, #2 <CR></p>
Salinity	<p>Meter Model, Serial Number, Software Revision, User ID, Date & Time, Sample ID, Channel, Mode, Salinity Value, Salinity Unit, Conductance Value, Conductance Unit, Temperature Value, Temperature Unit, Salinity Type, Reference Temperature Value, Reference Temperature Unit, Cell Constant Value, Cell Constant Unit, Method #, Log #</p> <p>Example: A212 Cond, X01038, 3.04, ABCDE, 01/03/15 16:05:41, SAMPLE, CH-1, SALT, 0.5112, psu, 1973.120, uS, 25.0, C, Practical Salinity, 15.0, C, 0.4750, /cm, M100, #3 <CR></p>
Resistivity	<p>Meter Model, Serial Number, Software Revision, User ID, Date & Time, Sample ID, Channel, Mode, Resistivity Value, Resistivity Unit, Conductance Value, Conductance Unit, Temperature Value, Temperature Unit, Temperature Coefficient Value, Temperature Coefficient Unit, Reference Temperature Value, Reference Temperature Unit, Cell Constant Value, Cell Constant Unit, Method #, Log #</p> <p>Example: A212 Cond, X01038, 3.04, ABCDE, 01/03/15 16:05:41, SAMPLE, CH-1, RES, 1068, Ohm-cm, 1982, uS, 25.0, C, 2.1, %/C, 25.0, C, 0.4750, /cm, M100, #4 <CR></p>
DO % Saturation	<p>Meter Model, Serial Number, Software Revision, User ID, Date & Time, Sample ID, Channel, Mode, Percent Saturation Value, Percent Saturation Unit, Concentration Value, Concentration Unit, Current Value, Current Unit, Solution Temperature Value, Solution Temperature Unit, Membrane Temperature Value, Membrane Temperature Unit, Barometric Pressure Value, Barometric Pressure Unit, Salinity Correction Value, Salinity Correction Unit, Slope Value, Slope Unit, Method #, Log #</p> <p>Example: A213 DO/RDO, X01039, 3.04, ABCDE, 01/03/15 16:05:41, SAMPLE, CH-1, DO, 0.3, % Sat, 0.03, mg/L, 3.4, nA, 24.5, C, 24.6, C, 761.0, mmHg, 0.0, ppt, 11.800, Na/%Sat, M100, #1 <CR></p>

Measure Mode	PC (CSV) Format
DO mg/L	<p>Meter Model, Serial Number, Software Revision, User ID, Date & Time, Sample ID, Channel, Mode, Concentration Value, Concentration Unit, Percent Saturation Value, Percent Saturation Unit, Current Value, Current Unit, Solution Temperature Value, Solution Temperature Unit, Membrane Temperature Value, Membrane Temperature Unit, Barometric Pressure Value, Barometric Pressure Unit, Salinity Correction Value, Salinity Correction Unit, Slope Value, Slope Unit, Method #, Log #</p> <p>Example: A213 DO/RDO, X01039, 3.04, ABCDE, 01/03/15 16:05:41, SAMPLE, CH-1, DO, 0.03, mg/L, 0.3,% sat, 3.4, nA, 24.5, C, 24.6, C, 761.0, mmHg, 0.0, ppt, 11.800, Na/%Sat, M100, #2 <CR></p>
RDO % Saturation	<p>Meter Model, Serial Number, Software Revision, User ID, Date & Time, Sample ID, Channel, Mode, Percent Saturation Value, Percent Saturation Unit, Concentration Value, Concentration Unit, Partial Pressure Value, Partial Pressure Unit, Solution Temperature Value, Solution Temperature Unit, Barometric Pressure Value, Barometric Pressure Unit, Salinity Correction Value, Salinity Correction Unit, Slope Value, Slope Unit, Method #, Log #</p> <p>Example: A213 DO/RDO, X01039, 3.04, ABCDE, 01/03/15 16:05:41, SAMPLE, CH-1, RDO, 100.0,% Sat, 8.40, mg/L, 138.5, Torr, 24.0, C, 761.0, mmHg, 0.0, ppt, 1.383, Torr/%Sat, M100, #3 <CR></p>
RDO mg/L	<p>Meter Model, Serial Number, Software Revision, User ID, Date & Time, Sample ID, Channel, Mode, Concentration Value, Concentration Unit, Percent Saturation Value, Percent Saturation Unit, Partial Pressure Value, Partial Pressure Unit, Solution Temperature Value, Solution Temperature Unit, Barometric Pressure Value, Barometric Pressure Unit, Salinity Correction Value, Salinity Correction Unit, Slope Value, Slope Unit, Method #, Log #</p> <p>Example: A213 DO/RDO, X01039, 3.04, ABCDE, 01/03/15 16:05:41, SAMPLE, CH-1, RDO, 8.40, mg/L, 100.0,% sat, 138.5, Torr, 24.0, C, 761.0, mmHg, 0.0, ppt, 1.383, Torr/%Sat, M100, #4 <CR></p>
Multi Channel	<p>Meter Model, Serial Number, Software Revision, User ID, Date & Time, Sample ID, (followed by measurement data for each channel, as shown above)</p> <p>Example: A215 pH/Cond, X01040, 3.04, ABCDE, 01/03/15 16:05:41, SAMPLE, CH-1, pH, 7.000, pH, 0.0, mV, 25.0, C, 98.1,% M100, CH-2, COND, 936.41, uS/cm, 1977.59, uS, 25.0, C, 2.1,%/C, 25.0, C, 0.4750, /cm, M200, #1 <CR></p>

Meter Calibration Data from GETCAL Command

Cal Mode	PC (CSV) Format
pH	<p>Meter Model, Serial Number, Software Revision, Channel, Mode, Calibration Date & Time, Total Calibration Points, repeated for each calibration point: Calibration Point, pH Value, pH Unit, mV Value, mV Unit, Temperature Value, Temperature Unit, repeated for each point-to-point segment: Slope Value, Slope Unit, repeated for each point-to-point segment: Offset Value, Offset Unit, Average Slope Value, Average Slope Unit, Calibration Number</p> <p>Example (5 point calibration): A211 pH, X01036, 3.04, CH-1, pH, 01/03/15 16:05:41, 5, 1, 2.00, pH, 290.5, mV, 25.0, C, 2, 4.01, pH, 174.3, mV, 25.0, C, 3, 7.00, pH, 0.0, mV, 25.0, C, 4, 10.01, pH, -173.9, mV, 25.0, C, 5, 12.00, pH, -289.7, mV, 25.0, C, 97.7,%, 98.5,%, 97.7,%, 98.4,%, 1.4, mV, 0.0, mV, 0.0, mV, 1.3, mV, 98.1,%, #1 <CR></p>
RmV	<p>Meter Model, Serial Number, Software Revision, Channel, Mode, Calibration Date & Time, Raw mV Value, Raw mV Unit, Relative mV Offset Value, Relative mV Offset Unit, Reference mV Value, Reference mV Unit, Calibration Number</p> <p>Example: A211 pH, X01036, 3.04, CH-1, RmV, 01/03/15 16:05:41, 0.0, mV, 0.0, mV, 0.0, mV, #1 <CR></p>
ORP	<p>Meter Model, Serial Number, Software Revision, Channel, Mode, Calibration Date & Time, Raw mV Value, Raw mV Unit, Offset Value, Offset Unit, Temperature Value, Temperature Unit, Calibration Number</p> <p>Example: A211 pH, X01036, 3.04, CH-1, ORP, 01/03/15 16:05:41, 176.9, mV, 242.6, mV, 25.0, C, #1 <CR></p>
ISE	<p>Meter Model, Serial Number, Software Revision, Channel, Mode, Calibration Date & Time, Total Calibration Points, repeated for each calibration point: Calibration Point, Concentration Value, Concentration Unit, mV Value, mV Unit, Temperature Value, Temperature Unit, repeated for each point-to-point segment: Slope Value, Slope Unit, repeated for each point-to-point segment: Offset Value, Offset Unit, Average Slope Value, Average Slope Unit, Blank Value, Blank Unit, Calibration Number</p> <p>Example (5 point calibration): A214 pH/ISE, X01036, 3.04, CH-1, ISE, 01/03/15 16:05:41, 5, 1, -1, ppb, 0.0, mV, 25.0, C, 2, 2, ppb, 19.0, mV, 25.0, C, 3, 300, ppb, 150.1, mV, 25.0, C, 4, -2000, ppb, 200.1, mV, 25.0, C, 5, 4000, ppb, 210.1, mV, 25.0, C, 63.1, mV/dec, 60.2, mV/dec, 60.7, mV/dec, 33.2, mV/dec, 0.0, mV, 0.9mV, 0.0mV, -0.2mV, 90.4, mV, 54.3, mV/dec, 0.0000, ppb, #1 <CR></p>
Conductivity	<p>Meter Model, Serial Number, Software Revision, Channel, Mode, Calibration Date & Time, Total Calibration Points, repeated for each calibration point: Calibration Point, Conductivity Value, Conductivity Unit, Conductance Value, Conductance Unit, Temperature Value, Temperature Unit (MTC/ATC), Calibration Type, Calibration Factor, Average Cell Constant (K), Calibration Number</p> <p>Example (5 point calibration): A212 Cond, X01038, 3.04, CH-1, Cond, 01/03/15 16:05:41, 5, 1, 52.8, uS/cm, 111.1, uS, 25.0, C, Manual, 0.4750, 2, 68.6, uS/cm, 143.1, uS, 25.0, C, Manual, 0.4956, 3, 100, uS/cm, 200.2, uS, 25.0, C, Manual, 0.5511, 4, 158.4, uS/cm, 333.4, uS, 25.0, C, Manual, 0.4375, 5, 475, uS/cm, 1000, uS, 25.0, C, Manual, 0.4749, 0.4868 #1 <CR></p>

Cal Mode	PC (CSV) Format
DO (Air or Water Calibration)	<p>Meter Model, Serial Number, Software Revision, Channel, Mode, Calibration Date & Time, Calibration Point, Calibration Type, Calibration Saturation Value, Calibration Saturation Unit, Set Zero Calibration Current Value, Set Zero Calibration Current Unit, Calibration Current Value, Calibration Current Unit, Solution Temperature Value, Solution Temperature Unit, Membrane Temperature Value, Membrane Temperature Unit, Calibration Pressure Value, Calibration Pressure Unit, Salinity Value, Salinity Unit, Calibration Slope Value, Calibration Slope Unit, Calibration Point, Calibration Number</p> <p>Example: A213 DO/RDO, X01039, 3.04, CH-1, DO, 01/03/15 16:05:41, 1, Auto- Air, 102.3,%, 0.0, nA, 405.1, nA, 5.0, C, 5.0, C, 736.1, mmHg, 0.0, ppt, 4.1, nA/%sat, 1, #1 <CR></p>
DO (Manual Calibration)	<p>Meter Model, Serial Number, Software Revision, Channel, Mode, Calibration Date & Time, Calibration Point, Calibration Type, Calibration Concentration Value, Calibration Concentration Unit, Set Zero Calibration Current Value, Set Zero Calibration Current Unit, Calibration Current Value, Calibration Current Unit, Solution Temperature Value, Solution Temperature Unit, Membrane Temperature Value, Membrane Temperature Unit, Calibration Pressure Value, Calibration Pressure Unit, Salinity Value, Salinity Unit, Calibration Slope Value, Calibration Slope Unit, Calibration Point, Calibration Number</p> <p>Example: A213 DO/RDO, X01039, 3.04, CH-1, DO, 01/03/15 16:05:41, 1, Manual, 12.62, mg/l, 0.0, nA, 405.1, nA, 5.0, C, 5.0, C, 736.1, mmHg, 0.0, ppt, 4.1, nA/%sat, 1, #2 <CR></p>
RDO (Air or Water Calibration)	<p>Meter Model, Serial Number, Software Revision, Channel, Mode, Calibration Date & Time, Probe Serial Number, Calibration Point, Calibration Type, Calibration Saturation Value, Calibration Saturation Unit, Set Zero Partial Pressure Value, Set Zero Partial Pressure Unit, Calibration Partial Pressure Value, Calibration Partial Pressure Unit, Solution Temperature Value, Solution Temperature Unit, Barometric Pressure Value, Barometric Pressure Unit, Salinity Value, Salinity Unit, Calibration Slope Value, Calibration Slope Unit, Calibration Point, Calibration Number</p> <p>Example: A213 DO/RDO, X01039, 3.04, CH-1, RDO, 01/03/15 16:05:41, 123454, 1, Auto-Air, 100.0,%, 8.2, Torr, 149.6, Torr, 24.3, C(ATC), 749.7, mmHg, 0.1, ppt, 1.52, Torr/%sat, 1, #1 <CR></p>
RDO (Manual Calibration)	<p>Meter Model, Serial Number, Software Revision, Channel, Mode, Calibration Date & Time, Probe Serial Number, Calibration Point, Calibration Type, Calibration Concentration Value, Calibration Concentration Unit, Set Zero Partial Pressure Value, Set Zero Partial Pressure Unit, Calibration Partial Pressure Value, Calibration Partial Pressure Unit, Solution Temperature Value, Solution Temperature Unit, Barometric Pressure Value, Barometric Pressure Unit, Salinity Value, Salinity Unit, Calibration Slope Value, Calibration Slope Unit, Calibration Point, Calibration Number</p> <p>Example: A213 DO/RDO, X01039, 3.04, CH-1, RDO, 12/16/12, 09:21:00, 123454, 1, Manual, 6.9, mg/l, 8.2, Torr, 149.6, Torr, 24.3, C(ATC), 749.7, mmHg, 0.1, ppt, 1.52, Torr/%sat, 1, #1 <CR></p>

Meter Software Upgrade Procedure

The software upgrade program for Orion Star A200 series and Orion A300 series meters has been tested with Microsoft Windows 7, XP and Vista operating systems only. We are always working to update our programs; however, the software update program has not been tested with any other operating systems at this time.

All computer screen savers and power management settings should be disabled when the meter is interfaced with the computer. The computer must not go into sleep/standby mode while the software update is performed. Many laptop computers go into sleep/standby mode when the lid is closed, so the lid should remain open throughout the software update. Laptop computers must also be plugged into a power supply when running the software update, performing the software update while the computer is on battery power is not recommended.

Note: Back up any stored meter data before upgrading the meter software.

1. Go to www.thermoscientific.com/OrionMeters, download the latest software for Orion Star A200-A300 series meters and unzip/extract the software files to the computer's desktop.
2. There are two versions of the Orion Star A200-A300 series meter software update for Windows 32-bit operating systems and Windows 64-bit operating systems. To determine which to use with your computer:
 - a. For Windows 7: Click the Start button and then click Control Panel. In the Control Panel window, click System if viewing by large icons or small icons or click System and Security and then click System if viewing by category. In the System window, next to System Type, either 32-bit or 64-bit will be shown.
 - b. For Windows XP: Click the Start button and then click Control Panel. In the Control Panel window, click the Performance and Maintenance link and then click the System icon or for Control Panel Classic View, just double-click the System icon. In the System Properties window, click the General tab and under System, if "x64 Edition" is shown, use the 64-bit version and if "x64 Edition" isn't shown, use the 32-bit version.
3. Uninstall any previous versions of the Orion Star A200-A300 series meter software update using the Computer's Programs and Features tool.

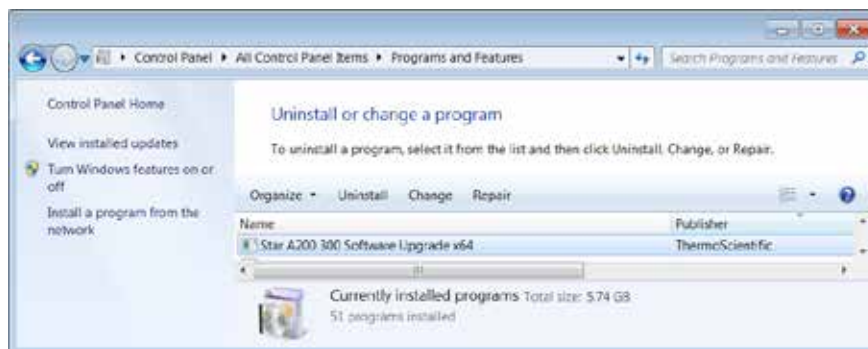

4. Make sure the computer interface cable is connected with the meter and computer and fully setup using the instructions in the [Using the USB-to-Serial Computer Cable](#) or [Using the USB Computer Cable](#) section.
5. Power on the meter. To ensure uninterrupted power through the update process, use the power adapter with benchtop meters and fully charged batteries or power adapter with portable meters.
6. Open the folder containing the unzipped/extracted software files and double click the setup.exe file to install the setup program onto the computer.

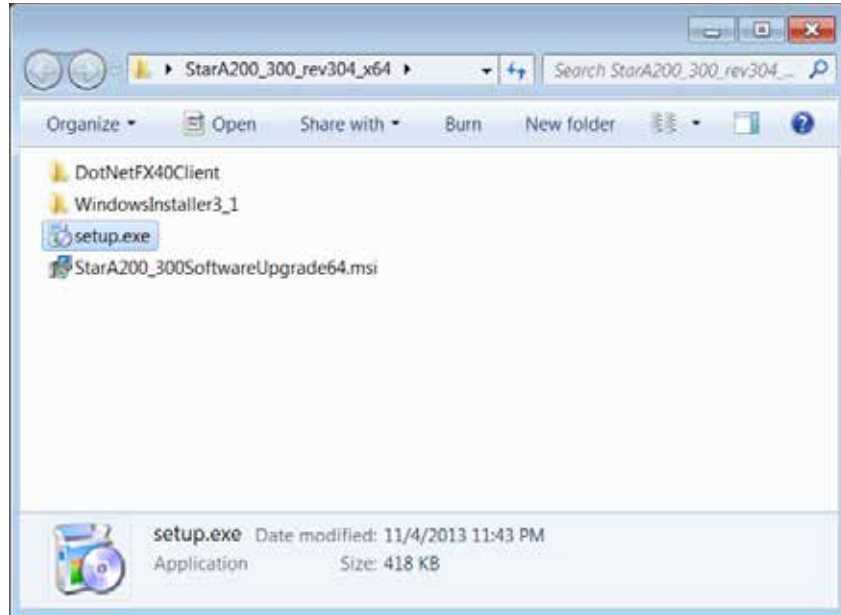

7. Follow all prompts to install the setup program onto the computer. If any security warning messages appear, select the run software option.



8. After successful installation of the setup program, a new StarA200_300SoftwareUpgrade icon will appear on the computer’s desktop. Double click the icon to launch the program.



9. Follow all prompts, including reviewing and accepting the licensing agreement, to start the software update. If any security warning messages appear, select the run software option.
10. Set the interface parameters for running the software update program.
 - a. When using the USB-to-Serial computer cable, select Serial as the connection method, enter the COM port location (viewable in Device Manager under Ports) and enter the current meter baud rate (default setting is 9600).

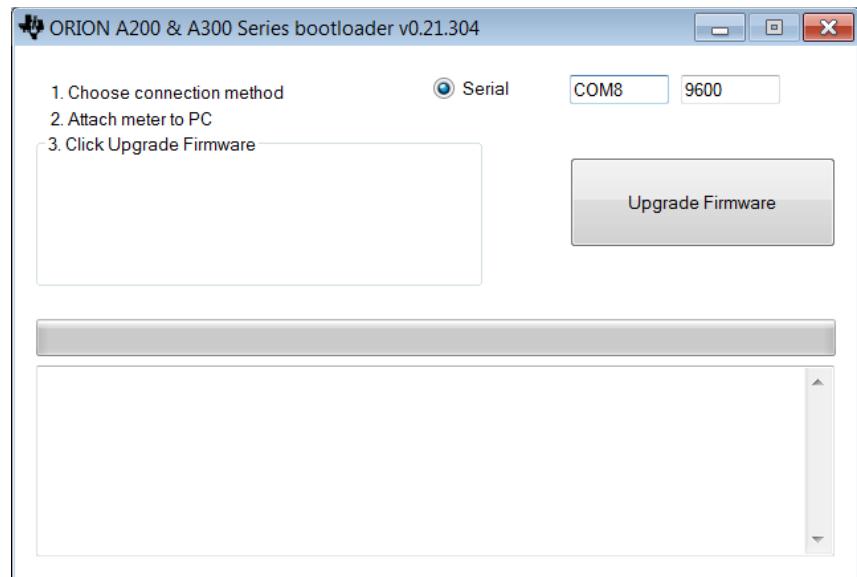

- b. When using the USB computer cable, the software update will detect the USB connection (USB driver must be installed prior to launching the software update).

11. Click the Upgrade Firmware button. Wait while the update is installed on the meter.
 - a. **Warning:** The software update must not be interrupted once the Update Firmware button is clicked. Interrupting the software update may corrupt the meter and cause it to not power on correctly.

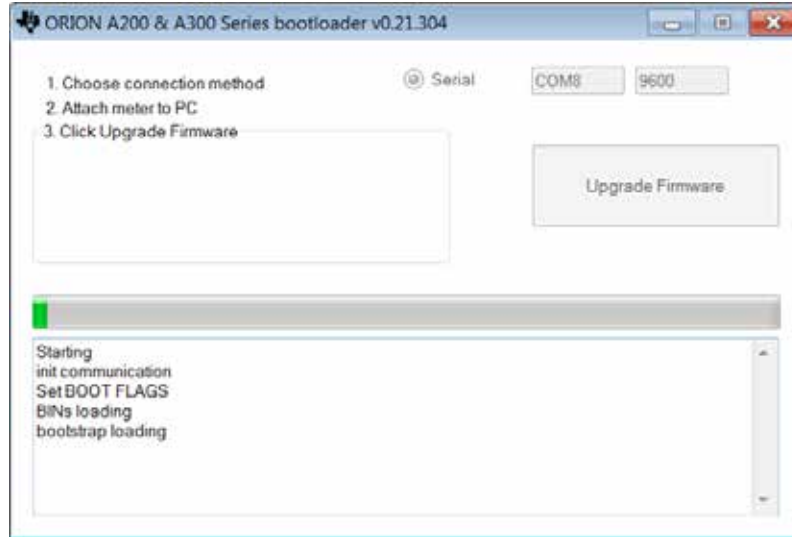

12. The update will take approximately 15 minutes. Once the software update is complete, the dialog box will show "Done!"

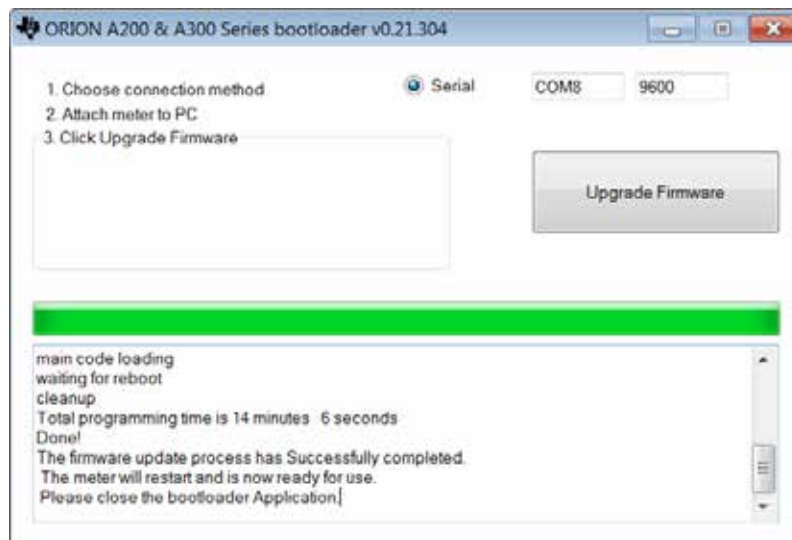

13. Close the software update and detach the cable from the meter and computer.

Note: If the following message is shown and the USB cable is being used, turn the power to the meter off by unplugging the power adapter and/or remove batteries, disconnect the USB cable, close the software update and retry this procedure using the RS232 cable.



8

CHAPTER 8 **Customer Services**

For any questions or if you require assistance, contact our Technical Support Specialists:

- Email wai.techservbev@thermofisher.com
- Within the United States, call 1-800-225-1480
- Outside the United States, call +1-978-232-6000 or fax +1-978-232-6031

For additional product information, contact your local authorized dealer, local Thermo Scientific Orion technical sales representative or contact us using the Water and Laboratory Products (WLP) information on the page back of this manual.

Visit www.thermoscientific.com/water to view Thermo Scientific Orion products and download product literature, user guides and manuals, software updates, and additional application and technical resources.

For the most current warranty information, refer to the Thermo Scientific Orion warranty card included on the Thermo Scientific Orion Star A320 series Meter literature CD and available online at www.thermoscientific.com/water.

Troubleshooting Tips

If an issue is encountered while using the Orion Star A320 series meter, ensure the correct power adapter is being used and try power cycling the meter: disconnect the power adapter from the meter, wait 15 seconds and reconnect the power adapter to the meter.

Meter Issue	Recommended Action
The measurement value is flashing 9999 and displaying Over Range or Under Range	The measurement is outside the allowable measurement range. Verify that the correct channel is shown on the meter display. Make sure the electrode or sensor is fully connected with the meter.
The meter locks up while connected to a computer via the USB cable	Disconnect the USB cable from the meter and computer and then disconnect and reconnect the power adapter from the meter. Reestablish the meter and computer USB connection.
The meter keypad is unresponsive when using the Star Com computer software	The keypad lock option is enabled in the Star Com computer program. To disable the keypad lock: in the Star Com program click the Settings icon, uncheck the box next to Keypad Lock and press the Save icon.
The measurement value freezes and will not change	The read type is set to Auto-Read mode (AR icon shown on the display). Press the measure (esc) key to take a new measurement or use the setup menu to change the read type to continuous.
The meter display goes blank, shows random lines or intermittently freezes	Ensure the correct power supply for the Star A series meter is being used. This power supply is different from the one supplied with Thermo Scientific Orion Versa Star meters. The use of a surge protector or uninterrupted power supply (UPS) is also recommended. Perform a factor reset on the meter.
The meter does not automatically recognize the pH buffer during calibration	Verify the correct buffer set was selected in the setup menu. The meter uses raw mV readings to recognize the buffer. As the electrode ages or becomes dirty, its mV readings will drift. Check the buffers and clean the electrode according to the instructions in the electrode manual.
The meter does not recognize the conductivity standard during calibration	Verify that the correct nominal cell constant is entered in the setup menu for the conductivity sensor being calibrated. The cell constant is typically printed on the cable of the conductivity sensor. Verify that the conductivity standard is one that can be automatically recognized by the meter. Recalibrate the conductivity sensor using new conductivity standard.
The meter does not recognize an RDO optical or polarographic dissolved oxygen sensor	Make sure the dissolved oxygen sensor is fully connected with the meter and verify the correct channel is shown on the meter display. Wait about 15 seconds after connecting a dissolved oxygen sensor for the meter to recognize the DO sensor type. Press the measure (esc) key to initiate a new measurement and update the meter display.

Meter Factory Reset Procedure

Warning: Performing a factory reset will erase the meter's calibration log and data log and reset all meter setup parameters to the factory default settings.

1. In the measurement mode, press the **setup** key.
2. Press the **p**, **q**, **t** or **u** key to highlight Diagnostics and press the **f3 (select)** key.
3. Press the **p** or **q** key to highlight Factory Reset and press the **f2 (select)** key.
4. Press the **f2 (yes)** key to start the factory reset procedure.
5. Press the **f3 (edit)** key to access the popup number entry screen and enter the default meter password of 111111.
 - a. Press the **p**, **q**, **t** or **u** key to highlight the number 1 and press the **f3 (enter)** key six times until 111111 is shown at the top of the screen.
 - b. Press the **f2 (done)** key to save the value and exit the number entry screen.
6. Press the **f2 (accept)** key to initiate the factory reset.
7. Wait while the factory reset is performed. Once completed, the meter will go through a power cycle and then proceed to the measurement mode. All meter settings will be reset to the factory default settings and the calibration log and data log will be erased.

Meter User Reset Procedure

1. In the measurement mode, press the **setup** key.
2. Press the **p**, **q**, **t** or **u** key to highlight Diagnostics and press the **f3 (select)** key.
3. Press the **p** or **q** key to highlight User Reset and press the **f2 (select)** key.
4. Press the **f2 (yes)** key to initiate the user reset procedure.
5. Wait while the user reset is performed. Once completed, the meter will proceed to the measurement mode. All meter settings will be reset to the factory default settings; however the calibration log and data log will be retained.

Notice of Compliance

This equipment generates, uses, and can radiate radio frequency energy and if not installed and used in accordance with the instruction manual, may cause interference to radio communications. It has been tested and found to comply with the limits for a Class A computing device pursuant to Subpart J of Part 15 of FCC Rules, which are designed to provide reasonable protection against such interference when operated in a commercial environment. Operation of this equipment in a residential area is likely to cause interference in which case the user, at his own expense, will be required to take whatever measures may be required to correct the interference.

“This digital apparatus does not exceed the (Class A) limits for radio noise emissions from digital apparatus set out in the Radio Interference Regulations of the Canadian Department of Communications.”

“Le present appareil numerique n’emet pas de bruits radioelectriques depassant les limites applicables aux appareils numeriques (de la class A) prescrites dans le Reglement sur le brouillage radioelectrique edicte par le ministere des Communications du Canada.”

WEEE Compliance

This product is required to comply with the European Union’s Waste Electrical & Electronic Equipment (WEEE) Directive 2002/96/EC. It is marked with the symbol shown here.



Further information on compliance with these directives, the recyclers in your country, and information on Thermo Scientific Orion products that may assist the detection of substances subject to the RoHS Directive are available by contact us using the Water and Laboratory Products (WLP) information on the back page of this manual.

Declaration of Conformity

Manufacturer: Thermo Fisher Scientific Inc
Address: Ayer Rajah Crescent
Blk 55 #04-16/24
Singapore 139949
Singapore

Hereby declares that the following products:

Thermo Scientific Orion Star A320 series portable meters are rated 100 to 240 VAC,
50/60 Hz, 0.5A

Portable Meter Models:

Orion Star A321 pH Meter
Orion Star A322 Conductivity Meter
Orion Star A323 RDO/DO Meter
Orion Star A324 pH/ISE Meter
Orion Star A325 pH/Conductivity Meter
Orion Star A326 pH/RDO/DO Meter
Orion Star A329 pH/ISE/Conductivity/RDO/DO Meter

Equipment Class:

Measurement, control and laboratory
Orion Star A-series meters are EMC Class A

Conforms with the following directives and standards:

EN61326-1:2013	Electromagnetic Compatibility (EMC Directive) Electrical equipment for measurement, control and laboratory use - EMC requirements
EN61010-1:2010	Safety Standards
UL61010-1:2012	Safety requirements for electrical equipment for measurement, control and laboratory use - general requirements.
CAN/CSA C22.2 No. 61010-1:2012	



Cheow Kwang Chan
QA/Regulatory Manager

Place and Date of Issue:
16 February 2015
Singapore

Meter Specifications



Orion Star A320 series Portable Meter Operating Conditions	
Operating Ambient Temperature	5 to 45 °C
Operating Relative Humidity	5 to 85%, non-condensing
Storage Temperature	-20 to 60 °C
Storage Relative Humidity	5 to 85%, non-condensing
Pollution	Degree 2
Overvoltage	Category II
Meter Weight	0.45 kg (1 lb)
Meter Dimensions (H x W x D)	6 cm x 10.5 cm x 24 cm (2.36" x 4.13" x 9.45")
Regulatory and Safety	CE, TUV 3-1, FCC Class A
Power Rating	DC input: 9VDC, 1A
	Battery: 4 x AA
Shock and Vibration	Shock: drop test in packaging per ISTA #1A
	Vibration: shipping/handling per ISTA #1A
Enclosure (designed to meet)	IP67
Warranty	3 years

Universal Power Adapter Operating Conditions	
Operating Ambient Temperature	0 to 50 °C
Operating Relative Humidity	0 to 90%, non-condensing
Storage Temperature	-20 to 75 °C
Storage Relative Humidity	0 to 90%, non-condensing
Pollution	Degree 2
Overvoltage	Category II

Orion Star A320 series Portable Meter Specifications	
Measurement Channels	1 to 3
Display	Graphic LCD
Measurement Modes	Auto-Read, Continuous, Timed
Data Log Memory	5000 data points with time and date stamp
Data Log Functions	Automatic logging with Auto-Read and Timed measure modes; manual logging with Continuous measure mode
Data Log Transfer	Transfer single, range or all data points to printer or computer
Data Log Editing	Delete all data points

Orion Star A320 series Portable Meter Specifications	
Calibration Log	10 calibrations per channel with time and date stamp
Methods	10 per channel with password protection
Alarms	Limit alarm, calibration alarm
Sample ID	Manual entry, auto-incremental or off
User ID	Manual entry or off
Computer Software	Orion Star Com data transfer software available free on website
Communication Ports	RS232, USB
Power Source	4 AA batteries (average 800 hours of battery life) or optional universal AC power adapter, 90-260 VAC, 50-60 Hz
Multilanguage User Interface	English, Spanish, French, Italian, German and Chinese Portuguese and Korean available with software update on web

Orion Star A321 pH Portable Meter Specifications		
Measurement Channels	1 – pH, mV, relative mV (RmV) or ORP with temperature	
pH	Range	- 2.000 to 20.000
	Resolution	0.1 / 0.01 / 0.001
	Relative Accuracy	±0.002
	Calibration Points	Up to 5
	Calibration Editing	Yes
	Input Impedance	> 10 ¹² ohms
	Electrode Status	Onscreen indicator for good, fair or bad electrode status
mV / RmV	Range	±2000.0 mV
	Resolution	0.1 mV
	Relative Accuracy	±0.2 mV or ±0.05% of reading, whichever is greater
	Relative mV Mode	Yes
	E _H ORP Mode	Yes
Temperature	Range	-5 to 105 °C, 22 to 221 °F
	Resolution	0.1 °C, 0.1 °F
	Relative Accuracy	±0.1 °C
	Offset Calibration	1 point
	Source Options	Manual or automatic with ATC probe
Sensor Inputs	BNC	pH or ORP electrode
	Pin Tip	Reference electrode
	8 pin MiniDIN	ATC temperature probe

Orion Star A322 Conductivity Portable Meter Specifications		
Measurement Channels		1 – conductivity, salinity, TDS or resistivity with temperature
Conductivity	Range	0.001 μ S to 3000 mS
	Resolution	0.001 μ S minimum, auto ranging, up to 4 significant digits
	Relative Accuracy	0.5% of reading ± 1 digit $> 3 \mu$ S, 0.5% of reading $\pm 0.01 \mu$ S $\leq 3 \mu$ S
	Reference Temperature	5 °C, 10 °C, 15 °C, 20 °C, 25 °C
	Temperature Compensation	Linear (0 to 10.0%/°C), nonlinear nLFn, nonlinear nLFu, EP (USP), off
	Cell Constants	0.001 to 199.9 cm^{-1}
	Calibration Points	Up to 5
	Calibration Editing	Yes
Salinity	Range	0.06 to 80.00 psu, 0.05 to 42.00 ppt
	Resolution	0.01 psu or 0.01 ppt minimum, auto ranging
	Relative Accuracy	0.5% of reading ± 1 digit
	Type	Practical salinity (psu) or natural sea water (ppt)
TDS	Range	0.001 to 200.0 ppm
	Resolution	0.001 ppm minimum, auto ranging, up to 4 significant digits
	Relative Accuracy	0.5% of reading ± 1 digit
	TDS Factor	Linear (0.02 to 9.99)
Resistivity	Range	2 Ω to 100 M Ω
	Resolution	1 Ω or 0.1 M Ω , auto ranging
	Relative Accuracy	0.5% of reading ± 1 digit
Temperature	Range	-5 to 105 °C, 22 to 221 °F
	Resolution	0.1 °C, 0.1 °F
	Relative Accuracy	± 0.1 °C
	Offset Calibration	1 point
	Source Options	Manual or automatic with built-in temperature sensor
Sensor Input	8 pin MiniDIN	Conductivity sensor with built-in temperature

Orion Star A323 RDO/DO Portable Meter Specifications			
Measurement Channels		1 – dissolved oxygen as % saturation or mg/L with temperature	
Dissolved Oxygen	Polarographic	Concentration	% Saturation
	Range	0 to 90 mg/L	0 to 600 %
	Resolution	0.01 / 0.1 mg/L	0.1 / 1 %
	Relative Accuracy	±0.2 mg/L or ±2% of reading, whichever is greater	±2% saturation or ±2% of reading, whichever is greater
	RDO Optical	Concentration	% Saturation
	Range	0 to 50 mg/L	0 to 500 %
	Resolution	0.01 / 0.1 mg/L	0.1 / 1 %
	Relative Accuracy	±0.1 mg/L up to 8 mg/L, ±0.2 mg/L 8 to 20 mg/L, ±10% of reading up to 50 mg/L	±2 % saturation ≤ 200 % saturation, ±10 % saturation > 200 % saturation
Barometric Pressure Correction		400 to 850 mmHg, automatic using built-in barometer (±6 mmHg) or manual entry	
Salinity Correction Factor		0.0 to 45.0 ppt, automatic using manual entry of sample salinity	
Calibration Types		Water-saturated air, air-saturated water, manual (Winkler), zero point	
Compatible Sensors		Polarographic, RDO optical	
Temperature	Range	0 to 50 °C, 32 to 122 °F	
	Resolution	0.1 °C, 0.1 °F	
	Relative Accuracy	±0.1 °C	
	Offset Calibration	1 point	
	Source Options	Automatic with built-in temperature sensor	
Sensor Input	9 pin MiniDIN	Dissolved oxygen sensor with built-in temperature	

Orion Star A324 pH/ISE Portable Meter Specifications		
Measurement Channels		1 – pH, mV, RmV, ORP or ion concentration with temperature
pH	Range	- 2.000 to 20.000
	Resolution	0.1 / 0.01 / 0.001
	Relative Accuracy	±0.002
	Calibration Points	Up to 5
	Calibration Editing	Yes
	Input Impedance	> 10 ¹² ohms
	Electrode Status	Onscreen indicator for good, fair or bad electrode status
ISE (Ion Concentration)	Range	0.0001 to 19900
	Resolution	0.0001 minimum, 1 to 3 significant digits (user selectable)
	Relative Accuracy	±0.2 mV or ±0.05% of reading, whichever is greater
	Units	ppm, Molar, mg/L, %, ppb, none
	Calibration Points	Up to 5
	Calibration Editing	Yes
	Advanced Features	Segmented (point-to-point) slope, non-linear selectable auto-blank, low concentration range stability
mV / RmV	Range	±2000.0 mV
	Resolution	0.1 mV
	Relative Accuracy	±0.2 mV or ±0.05% of reading, whichever is greater
	Relative mV Mode	Yes
	E _H ORP Mode	Yes
Temperature	Range	-5 to 105 °C, 22 to 221 °F
	Resolution	0.1 °C, 0.1 °F
	Relative Accuracy	±0.1 °C
	Offset Calibration	1 point
	Source Options	Manual or automatic with ATC probe
Sensor Inputs	BNC	pH electrode, ORP electrode or ion selective electrode (ISE)
	Pin Tip	Reference electrode
	8 pin MiniDIN	ATC temperature probe

Orion Star A325 pH/Conductivity Portable Meter Specifications		
Measurement Channels		2 – Ch. 1: pH, mV, relative mV (RmV) or ORP with temperature Ch. 2: conductivity, salinity, TDS or resistivity with temperature
pH	Range	- 2.000 to 20.000
	Resolution	0.1 / 0.01 / 0.001
	Relative Accuracy	±0.002
	Calibration Points	Up to 5
	Calibration Editing	Yes
	Input Impedance	> 10 ¹² ohms
	Electrode Status	Onscreen indicator for good, fair or bad electrode status
mV / RmV	Range	±2000.0 mV
	Resolution	0.1 mV
	Relative Accuracy	±0.2 mV or ±0.05% of reading, whichever is greater
	Relative mV Mode	Yes
	E _H ORP Mode	Yes
Conductivity	Range	0.001 µS to 3000 mS
	Resolution	0.001 µS minimum, auto ranging, up to 4 significant digits
	Relative Accuracy	0.5% of reading ±1 digit > 3 µS, 0.5% of reading ±0.01 µS ≤ 3 µS
	Reference Temp.	5 °C, 10 °C, 15 °C, 20 °C, 25 °C
	Temp. Comp.	Linear, nonlinear nLFn, nonlinear nLFu, EP (USP), off
	Calibration Points	Up to 5 with calibration editing option
Salinity	Range	0.06 to 80.00 psu, 0.05 to 42.00 ppt
	Resolution	0.01 psu or 0.01 ppt minimum, auto ranging
	Relative Accuracy	0.5% of reading ±1 digit
	Type	Practical salinity (psu) or natural sea water (ppt)
TDS	Range	0.001 to 200.0 ppm
	Resolution	0.001 ppm minimum, auto ranging, up to 4 significant digits
	Relative Accuracy	0.5% of reading ±1 digit
	TDS Factor	Linear (0.02 to 9.99)
Resistivity	Range	2 Ω to 100 MΩ
	Resolution	1 Ω or 0.1 MΩ, auto ranging
	Relative Accuracy	0.5% of reading ±1 digit
Temperature	Range	-5 to 105 °C, 22 to 221 °F
	Resolution	0.1 °C, 0.1 °F
	Relative Accuracy	±0.1 °C
	Offset Calibration	1 point
	Source Options	Manual or automatic with ATC probe or built-in temp. sensor
Sensor Inputs	BNC	pH or ORP electrode
	Pin Tip	Reference electrode
	8 pin MiniDIN	Conductivity sensor with built-in temperature or ATC probe

Orion Star A326 pH/RDO/DO Portable Meter Specifications			
Measurement Channels		2 – Ch. 1: pH, mV, relative mV (RmV) or ORP with temperature Ch. 2: dissolved oxygen as % saturation or mg/L with temperature	
pH	Range	- 2.000 to 20.000	
	Resolution	0.1 / 0.01 / 0.001	
	Relative Accuracy	±0.002	
	Calibration Points	Up to 5	
	Calibration Editing	Yes	
	Input Impedance	> 10 ¹² ohms	
	Electrode Status	Onscreen indicator for good, fair or bad electrode status	
mV / RmV	Range	±2000.0 mV	
	Resolution	0.1 mV	
	Relative Accuracy	±0.2 mV or ±0.05% of reading, whichever is greater	
	Relative mV Mode	Yes	
	E _H ORP Mode	Yes	
Dissolved Oxygen	Polarographic	Concentration	% Saturation
	Range	0 to 90 mg/L	0 to 600 %
	Resolution	0.01 / 0.1 mg/L	0.1 / 1 %
	Relative Accuracy	±0.2 mg/L or ±2% of reading, whichever is greater	±2 % saturation or ±2% of reading, whichever is greater
	RDO Optical	Concentration	% Saturation
	Range	0 to 50 mg/L	0 to 500 %
	Resolution	0.01 / 0.1 mg/L	0.1 / 1 %
	Relative Accuracy	±0.1 mg/L up to 8 mg/L, ±0.2 mg/L 8 to 20 mg/L, ±10% of reading up to 50 mg/L	±2 % saturation ≤ 200 % saturation, ±10 % saturation > 200 % saturation
	Barometric Pressure Correction	400 to 850 mmHg, automatic using built-in barometer (±6 mmHg) or manual entry	
	Salinity Correction	0.0 to 45.0 ppt, automatic using manual entry of sample salinity	
	Calibration Types	Water-saturated air, air-saturated water, manual, zero point	
	Compatible Sensors	Polarographic, RDO optical	
Temperature	Range	0 to 50 °C, 32 to 122 °F	
	Resolution	0.1 °C, 0.1 °F	
	Relative Accuracy	±0.1 °C	
	Offset Calibration	1 point	
	Source Options	Manual or automatic with ATC probe or built-in temp. sensor	
Sensor Inputs	BNC	pH or ORP electrode	
	Pin Tip	Reference electrode	
	8 pin MiniDIN	ATC temperature probe	
	9 pin MiniDIN	Dissolved oxygen sensor with built-in temperature	

Orion Star A329 pH/ISE/Conductivity/RDO/DO Portable Meter Specifications		
Measurement Channels		3 – Ch. 1: pH, mV, RmV, ORP or ISE with temperature Ch. 2: conductivity, salinity, TDS or resistivity with temperature Ch. 3: dissolved oxygen as % saturation or mg/L with temperature
pH	Range	- 2.000 to 20.000
	Resolution	0.1 / 0.01 / 0.001
	Relative Accuracy	±0.002
	Calibration Points	Up to 5
	Calibration Editing	Yes
	Input Impedance	> 10 ¹² ohms
	Electrode Status	Onscreen indicator for good, fair or bad electrode status
ISE (Ion Concentration)	Range	0.0001 to 19900
	Resolution	0.0001 minimum, 1 to 3 significant digits (user selectable)
	Relative Accuracy	±0.2 mV or ±0.05% of reading, whichever is greater
	Units	ppm, Molar, mg/L, %, ppb, none
	Calibration Points	Up to 5
	Calibration Editing	Yes
	Advanced Features	Segmented (point-to-point) slope, non-linear selectable auto-blank, low concentration range stability
mV / RmV	Range	±2000.0 mV
	Resolution	0.1 mV
	Relative Accuracy	±0.2 mV or ±0.05% of reading, whichever is greater
	Relative mV Mode	Yes
	E _H ORP Mode	Yes
Conductivity	Range	0.001 µS to 3000 mS
	Resolution	0.001 µS minimum, auto ranging, up to 4 significant digits
	Relative Accuracy	0.5% of reading ±1 digit > 3 µS, 0.5% of reading ±0.01 µS ≤ 3 µS
	Reference Temp.	5 °C, 10 °C, 15 °C, 20 °C, 25 °C
	Temp. Comp.	Linear, nonlinear nLFn, nonlinear nLFu, EP (USP), off
	Calibration Points	Up to 5 with calibration editing option
Salinity	Range	0.06 to 80.00 psu, 0.05 to 42.00 ppt
	Resolution	0.01 psu or 0.01 ppt minimum, auto ranging
	Relative Accuracy	0.5% of reading ±1 digit
	Type	Practical salinity (psu) or natural sea water (ppt)
TDS	Range	0.001 to 200.0 ppm
	Resolution	0.001 ppm minimum, auto ranging, up to 4 significant digits
	Relative Accuracy	0.5% of reading ±1 digit
	TDS Factor	Linear (0.02 to 9.99)
Resistivity	Range	2 Ω to 100 MΩ
	Resolution	1 Ω or 0.1 MΩ, auto ranging
	Relative Accuracy	0.5% of reading ±1 digit

Orion Star A329 pH/ISE/Conductivity/RDO/DO Portable Meter Specifications			
Dissolved Oxygen	Polarographic	Concentration	% Saturation
	Range	0 to 90 mg/L	0 to 600 %
	Resolution	0.01 / 0.1 mg/L	0.1 / 1 %
	Relative Accuracy	±0.2 mg/L or ±2% of reading, whichever is greater	±2 % saturation or ±2% of reading, whichever is greater
	RDO Optical	Concentration	% Saturation
	Range	0 to 50 mg/L	0 to 500 %
	Resolution	0.01 / 0.1 mg/L	0.1 / 1 %
	Relative Accuracy	±0.1 mg/L up to 8 mg/L, ±0.2 mg/L 8 to 20 mg/L, ±10% of reading up to 50 mg/L	±2 % saturation ≤ 200 % saturation, ±10 % saturation > 200 % saturation
	Barometric Pressure Correction	400 to 850 mmHg, automatic using built-in barometer (±6 mmHg) or manual entry	
	Salinity Correction	0.0 to 45.0 ppt, automatic using manual entry of sample salinity	
	Calibration Types	Water-saturated air, air-saturated water, manual, zero point	
	Compatible Sensors	Polarographic, RDO optical	
Temperature	Range	0 to 50 °C, 32 to 122 °F	
	Resolution	0.1 °C, 0.1 °F	
	Relative Accuracy	±0.1 °C	
	Offset Calibration	1 point	
	Source Options	Manual or automatic with ATC probe or built-in temp. sensor	
Sensor Inputs	BNC	pH, ORP or ISE electrode	
	Pin Tip	Reference electrode	
	8 pin MiniDIN	Conductivity sensor with built-in temperature or ATC probe	
	9 pin MiniDIN	Dissolved oxygen sensor with built-in temperature	

Note: All specifications are subject to change without notice.

Ordering Information

Cat. No.	Description
STARA3210	Star A321 pH meter with 4 AA batteries, literature CD, printed quick start guide, computer interface cable and meter test certificate
STARA3215	Star A321 pH meter kit with 4 AA batteries, literature CD, printed quick start guide, computer interface cable and meter test certificate <ul style="list-style-type: none"> • 8107UWMMD ROSS Ultra Triode gel-filled epoxy-body pH/ATC electrode, 3 m cable • 910410-WA / 910710 / 911010 Orion pH 4 / 7 / 10 buffer pouches, 10 pack each • 810001 ROSS electrode storage solution, 475 mL • 911110 Orion rinse solution pouches, 10 pack • STARA-AR Orion Star A series portable meter armor • STARA-CS Orion Star A series hard-sided field case
STARA3220	Star A322 conductivity meter with 4 AA batteries, literature CD, printed quick start guide, computer interface cable and meter test certificate
STARA3225	Star A322 conductivity meter kit with 4 AA batteries, literature CD, printed quick start guide, computer interface cable and meter test certificate <ul style="list-style-type: none"> • 013010MD DuraProbe 4-cell (K=0.475) epoxy-body conductivity sensor, 3 m cable • 01100710 Orion 1413 μS conductivity standard pouches, 10 pack • 911110 Orion rinse solution pouches, 10 pack • STARA-AR Orion Star A series portable meter armor • STARA-CS Orion Star A series hard-sided field case
STARA3230	Star A323 RDO/DO meter with 4 AA batteries, literature CD, printed quick start guide, computer interface cable and meter test certificate
STARA3235	Star A323 RDO/DO meter kit with 4 AA batteries, literature CD, printed quick start guide, computer interface cable and meter test certificate <ul style="list-style-type: none"> • 087010MD RDO optical DO sensor with 3m cable, calibration sleeve and guard • STARA-AR Orion Star A series portable meter armor • STARA-CS Orion Star A series hard-sided field case
STARA3240	Star A324 pH/ISE meter with 4 AA batteries, literature CD, printed quick start guide, computer interface cable and meter test certificate
STARA3245	Star A324 pH/ISE meter kit with 4 AA batteries, literature CD, printed quick start guide, computer interface cable and meter test certificate <ul style="list-style-type: none"> • 8107UWMMD ROSS Ultra Triode gel-filled epoxy-body pH/ATC electrode, 3 m cable • 910410-WA / 910710 / 911010 Orion pH 4 / 7 / 10 buffer pouches, 10 pack each • 810001 ROSS electrode storage solution, 475 mL • 911110 Orion rinse solution pouches, 10 pack • STARA-AR Orion Star A series portable meter armor • STARA-CS Orion Star A series hard-sided field case
STARA3250	Star A325 pH/conductivity meter with 4 AA batteries, literature CD, printed quick start guide, computer interface cable and meter test certificate

Cat. No.	Description
STARA3255	<p>Star A325 pH/conductivity meter kit with 4 AA batteries, literature CD, printed quick start guide, computer cable and meter test certificate</p> <ul style="list-style-type: none"> • 8107UWMMMD ROSS Ultra Triode gel-filled epoxy-body pH/ATC electrode, 3 m cable • 013010MD DuraProbe 4-cell (K=0.475) epoxy-body conductivity sensor, 3 m cable • 910410-WA / 910710 / 911010 Orion pH 4 / 7 / 10 buffer pouches, 10 pack each • 810001 ROSS electrode storage solution, 475 mL • 911110 Orion rinse solution pouches, 10 pack • 01100710 Orion 1413 μS conductivity standard pouches, 10 pack • STARA-AR Orion Star A series portable meter armor • STARA-CS Orion Star A series hard-sided field case
STARA3260	<p>Star A326 pH/RDO/DO meter with 4 AA batteries, literature CD, printed quick start guide, computer interface cable and meter test certificate</p>
STARA3265	<p>Star A326 pH/RDO/DO meter kit with 4 AA batteries, literature CD, printed quick start guide, computer interface cable and meter test certificate</p> <ul style="list-style-type: none"> • 8107UWMMMD ROSS Ultra Triode gel-filled epoxy-body pH/ATC electrode, 3 m cable • 087010MD RDO optical DO sensor with 3m cable, calibration sleeve and guard • 910410-WA / 910710 / 911010 Orion pH 4 / 7 / 10 buffer pouches, 10 pack each • 810001 ROSS electrode storage solution, 475 mL • STARA-AR Orion Star A series portable meter armor • STARA-CS Orion Star A series hard-sided field case
STARA3290	<p>Star A329 pH/ISE/conductivity/RDO/DO meter with 4 AA batteries, literature CD, printed quick start guide, computer interface cable and meter test certificate</p>
STARA3295	<p>Star A329 pH/ISE/conductivity/RDO/DO meter kit with 4 AA batteries, literature CD, printed quick start guide, computer interface cable and meter test certificate</p> <ul style="list-style-type: none"> • 8107UWMMMD ROSS Ultra Triode gel-filled epoxy-body pH/ATC electrode, 3 m cable • 013010MD DuraProbe 4-cell (K=0.475) epoxy-body conductivity sensor, 3 m cable • 087010MD RDO optical DO sensor with 3m cable, calibration sleeve and guard • 910410-WA / 910710 / 911010 Orion pH 4 / 7 / 10 buffer pouches, 10 pack each • 810001 ROSS electrode storage solution, 475 mL • 911110 Orion rinse solution pouches, 10 pack • 01100710 Orion 1413 μS conductivity standard pouches, 10 pack • STARA-AR Orion Star A series portable meter armor • STARA-CS Orion Star A series hard-sided field case

Meter Accessories, Electrodes and Solutions

Cat. No.	Description
IQOQ-STARA	Star A210, Star A220 and Star A320 series meter IQ/OQ (installation qualification / operation qualification) documentation, valid for all listed meter configurations
STARA-AR	Orion Star A series portable meter armor with pH electrode holder, conductivity and DO sensor holder, adjustable hand-strap and built-in stand
STARA-ESPH	Orion Star A series pH electrode holder for portable meter armor
STARA-ESCD	Orion Star A series conductivity and DO sensor holder for portable meter armor
STARA-CS	Orion Star A series portable meter hard-sided field case
1210005	Orion Star series portable meter soft-sided field case
810017	Storage sleeve and base for 12mm diameter electrodes

Cat. No.	Description
1010003	Universal power adapter for Star A series meters
1010053	Star series RS232 computer cable
1010005	Star series RS232 to USB cable and adapter
1010006	Star series inkjet printer, 110V/220V, with RS232 printer cable
927007MD	Orion ATC temperature probe with stainless steel body, MiniDIN connector
927005MD	Orion ATC temperature probe with epoxy body, MiniDIN connector
928007MD	Orion micro ATC temperature probe with stainless steel tip, MiniDIN connector
8102BNUWP	ROSS Ultra glass-body refillable pH electrode, BNC connector
8156BNUWP	ROSS Ultra epoxy-body refillable pH electrode, BNC connector
8172BNWP	ROSS Sure-Flow glass-body refillable pH electrode, BNC connector
8165BNWP	ROSS Sure-Flow epoxy-body refillable pH electrode, BNC connector
8302BNUMD	ROSS Ultra Triode glass-body refillable pH/ATC electrode, BNC & MiniDIN connectors
8157BNUMD	ROSS Ultra Triode epoxy-body refillable pH/ATC electrode, BNC & MiniDIN connectors
8107BNUMD	ROSS Ultra Triode epoxy-body gel-filled pH/ATC electrode, BNC & MiniDIN connectors
8107UWMMMD	ROSS Ultra Triode epoxy-body gel-filled pH/ATC electrode, BNC & MiniDIN connectors, 3m cable
9107BNMD	Orion Triode epoxy-body gel-filled pH/ATC electrode, BNC & MiniDIN connectors
GD9106BNWP	Orion Green Double Junction epoxy-body gel-filled pH electrode, BNC connector
9156DJWP	Orion Double Junction epoxy-body gel-filled pH electrode, BNC connector
8135BNUWP	ROSS Ultra epoxy-body refillable pH electrode with flat surface bulb, BNC connector
8163BNWP	ROSS spear tip glass-body refillable pH electrode, BNC connector
810199	ROSS All-in-One pH buffer and storage solution kit, includes pH 4, 7, 10 buffers; ROSS storage solution; pH electrode cleaning solution; pH electrode storage bottle
810001	ROSS pH electrode storage solution, 475 mL
910001	Standard pH electrode storage solution, 475 mL
910168	Orion pH 1.68 buffer, 475 mL
910104	Orion pH 4.01 buffer, 475 mL
910410-WA	Orion pH 4.01 buffer pouches, 10 pack
910425	Orion pH 4.01 buffer pouches, 25 pack
910105	Orion pH 5.00 buffer, 475 mL
910686	Orion pH 6.86 buffer, 475 mL
910107	Orion pH 7.00 buffer, 475 mL
910710	Orion pH 7.00 buffer pouches, 10 pack
910725	Orion pH 7.00 buffer pouches, 25 pack
910918	Orion pH 9.18 buffer, 475 mL
910110	Orion pH 10.01 buffer, 475 mL
911010	Orion pH 10.01 buffer pouches, 10 pack
911025-WA	Orion pH 10.01 buffer pouches, 25 pack
910112	Orion pH 12.46 buffer, 475 mL

Cat. No.	Description
9678BNWP	Orion Sure-Flow ORP epoxy-body refillable electrode, BNC connector
9180BNMD	Orion Triode ORP/ATC epoxy-body refillable electrode, BNC & MiniDIN connectors
9179BNMD	Orion Triode ORP/ATC epoxy-body gel-filled electrode, BNC & MiniDIN connectors
967901	Orion ORP standard solution, 475 mL
967961	Orion ORP standard solution, 5 x 60 mL
9512HPBNWP	Orion high-performance ammonia ion selective electrode, BNC connector
9512BNWP	Orion standard ammonia ion selective electrode, BNC connector
951007	Orion 1000 ppm ammonia standard, 475 mL
951211	Orion ammonia ionic strength adjuster (ISA) with pH-indicating blue dye, 475 mL
951210	Orion low level ammonia ISA with pH-indicating blue dye, 475 mL
9609BNWP	Orion fluoride ion selective electrode, BNC connector
940907	Orion 100 ppm fluoride standard, 475 mL
940909	Orion TISAB II total ionic strength adjustment buffer for fluoride analysis, 3.8 L
040906	Orion 1 ppm fluoride standard premixed with TISAB II, 475 mL
040907	Orion 2 ppm fluoride standard premixed with TISAB II, 475 mL
040908	Orion 10 ppm fluoride standard premixed with TISAB II, 475 mL
9707BNWP	Orion nitrate ion selective electrode, BNC connector
920707	Orion 1000 ppm nitrate standard, 475 mL
930711	Orion nitrate ionic strength adjuster (ISA), 475 mL
930710	Orion nitrate interference suppressor solution, 475 mL
8611BNWP	ROSS sodium ion selective electrode, BNC connector
841108	Orion 1000 ppm sodium standard, 475 mL
841111	Orion sodium ionic strength adjuster (ISA), 475 mL
013005MD	Orion DuraProbe 4-cell (K=0.475) conductivity/temperature sensor, MiniDIN connector
013010MD	Orion DuraProbe 4-cell (K=0.475) cond./temp. sensor, MiniDIN connector, 3m cable
013020MD	Orion DuraProbe 4-cell (K=0.475) cond./temp. sensor, MiniDIN connector, 6m cable
013016MD	Orion pure water 2-cell (K=0.1) conductivity/temperature sensor, MiniDIN connector
018020MD	Orion high range 2-cell conductivity sensor (K=10), MiniDIN connector
011008	Orion 100 μ S/cm conductivity standard, 5 x 60 mL
011007	Orion 1413 μ S/cm conductivity standard,, 5 x 60 mL
011006	Orion 12.9 mS/cm conductivity standard, 5 x 60 mL
1010001	Orion conductivity verification resistor kit
083005MD	Orion polarographic DO sensor with calibration sleeve, MiniDIN connector
083010MD	Orion polarographic DO sensor with calibration sleeve, MiniDIN connector, 3m cable
087010MD	RDO optical DO sensor with cap, cal sleeve and guard, MiniDIN connector, 3m cable
087020MD	RDO optical DO sensor with cap, cal sleeve and guard, MiniDIN connector, 6m cable

Visit www.thermoscientific.com/water for a complete listing of all available Thermo Scientific Orion meters, electrodes, solutions and accessories.

thermoscientific.com/water

© 2015 Thermo Fisher Scientific Inc. All rights reserved. RDO is a registered trademark of In-Situ Inc. Microsoft, Windows and Microsoft Vista are registered trademarks of Microsoft Corporation. All other trademarks are the property of Thermo Fisher Scientific Inc. & its subsidiaries.

Water and Lab Products

North America

Toll Free: 1-800-225-1480
Tel: 1-978-232-6000
Info.water@thermofisher.com

Germany

Tel: (49) 6184-90-6000
info.water.uk@thermofisher.com

China

Tel: (86) 21-68654588
wai.asia@thermofisher.com

India

Tel: (91) 22-4157-8800
wai.asia@thermofisher.com

Singapore

Tel: (65) 6778-6876
wai.asia@thermofisher.com

Japan

Tel: (81) 045-453-9175
wai.asia@thermofisher.com

Australia

Tel: (613) 9757-4300
In Australia (1300) 735-295
InfoWaterAU@thermofisher.com

Thermo
SCIENTIFIC

A Thermo Fisher Scientific Brand