



# Thermo Scientific™ Decapper 500 and 550 Operator's Manual

Version 01

User Manual • November 2016

This page intentionally left blank

# Contents

General Information	1-1
<hr/>	
Safety	2-1
<hr/>	
Installation and Set-up	3-1
Hardware Installation	3-1
3.1 Power on the Device	3-1
3.2 Display Orientation and Viewing Angle	3-2
3.3 Labware Specific Adapters	3-2
3.3 Remove Labware Specific Adapters	3-2
3.3 Exchange of Tube Rack and Cap Holder	3-2
3.3 Settings options	3-2
<hr/>	
Installation for Decapper 550	4-1
Connecting Decapper 550 to your PC	4-1
<hr/>	
Operation	5-1
Progress	5-1
Camera Picture	5-1
Results	5-1
Rack	5-1
<hr/>	
Creating a Profile in the Decapper 550 Software	6-1
Create a Profile	6-1
<hr/>	
Update and Labware Installation	7-1
Software Update	7-1
<hr/>	
Service and Error Handling	8-1
<hr/>	
Technical Specifications	9-1
<hr/>	
Appendix	10-1
<hr/>	

This page intentionally left blank

# 1 - General Information

The Thermo Scientific™ Decapper 500 provides automated decapping and capping of Thermo Scientific™ Matrix™ and Thermo Scientific™ Nunc™ Tubes with screw top closures in ANSI racks. Quick Switch Technology allows researchers who use both Matrix and Nunc tubes to seamlessly switch between cap styles and rack styles, 96- and 48-format, with only a quick switch of the cap adaptors in the head of the unit. The Decapper 550 includes a built-in barcode reader, eliminating the need for additional instruments.

This Operator's Manual is designed to help you get the most out of your decapping device. This chapter should be read thoroughly before using your decapper device. It contains important notes about the decappers' use and this manual's contents.

Your Decapper can be one of the following versions:

Part No.	Devices
4117-500	Thermo Scientific Decapper 500
4117-550	Thermo Scientific Decapper 550 with integrated barcode reader



## About This Manual

For information that relates to both the Thermo Scientific Decapper 500 and Decapper 550, we will simply refer to as "Decapper." Operation is the same across both devices. For specific information that relates to only one particular model (e.g. the Decapper 550) we will refer to your specific decapping device.

This manual is to help operators run the Decapper correctly and safely. It has been developed for



use with the Decapper 500 and 550, including accessories and software (Decapper 550 only) and should not be used with any other decapping equipment or software available in the market.

After introducing you to the various parts of the Decapper, the manual shows you, step by step, how to perform typical operations. Warnings and useful notes are included in this manual to emphasize important and critical instructions. They are printed in italics; begin with the word "Caution" accompanied by the  symbol, or the word "Note" accompanied by the  symbol, as appropriate.



**CAUTION:** Any special issues, warnings or important information will be accompanied by this symbol. Read these items carefully.

**NOTE:** This is used to give information to the Decapper operator that is useful, but not essential to the task at hand.

## Terminology

For terminology information see the glossary in the appendix, section

## Intended Use

The Decapper decaps and caps storage tubes held in ANSI racks. The instrument must always be installed on a stable table or laboratory bench.

The Decapper conforms to U.S. and European norms in regards to interference immunity. It is recommended that the Decapper be kept away from other equipment that emits strong electromagnetic RF fields in the laboratory or offices.

If the Decapper is used in a manner not specified by Thermo Fisher Scientific, the protection provided by the equipment may be impaired.

## Operation of the Decapper

Any person can install and use the Decapper. The instructions in this Operator's Manual provide

sufficient information to allow easy and safe use of the instruments.

## Cleaning

The Decapper can be cleaned with a lint-free non-abrasive cloth. If necessary, wet the cloth with Ethanol (70%) or a disinfection solution. The same cleaning method can be applied to the adapter mandrels within each adaptor kit.



**CAUTION: Do not use disinfecting materials, which contain hypochlorite (Javel water, Chlorox) or bleaching fluids.**

**The Decapper window must be completely dry before use.**

### Recommended disinfecting for cap trays:

4906	Cap Tray for Matrix Screwtop Tubes 0.5mL and 1.0mL	Disposable Disinfect with 70% alcohol Not recommended for autoclaving
4118-201	Thermo Scientific Decapper 550 with integrated barcode reader	Disposable Disinfect with 70% alcohol Not recommended for autoclaving
4118-202	Cap Tray for Nunc Universal 1.8mL Tubes	Autoclavable
4118-203	Cap Tray for Nunc Universal 2.0mL Tubes and Nunc Cryobank 2.0mL Tubes	Autoclavable

# 2 - Safety

This section describes the main safety considerations in operating this product, and the main hazards involved.







The safety of personnel and equipment can only be ensured if these safety instructions and the safety-related warnings in the individual chapters are strictly observed and followed.

If the product is used as intended, the operator is able to recognize and avoid dangers.

 **CAUTION:** Read the following safety notices very carefully before using the Decapper.

## Notices and Symbols

Safety Labels and Warning Notices used in this manual:

-  **Power connection**  
Connect only to earth-grounded outlet.
-  **Connection to PC**  
Use only the appropriate shielded cables.
-  **Biohazard warning**  
Instrument, especially moving stage and cap holder, may contain bio-hazardous or chemically contaminated materials.
-  **Laser beam**  
Do not stare into beam of the class 1 laser.
-  **Moving parts**  
Moving parts could lead to injuries. Do not remove or place labware while instrument is processing.
-  **Moving parts**  
Parts will move while the instrument is performing the initialization. Please do not place your hands on moving parts, this could lead to injuries.



## Warning Labels Attached to the Instrument

To prevent hazards, warning labels are attached

### Power Supply and Communication Interfaces

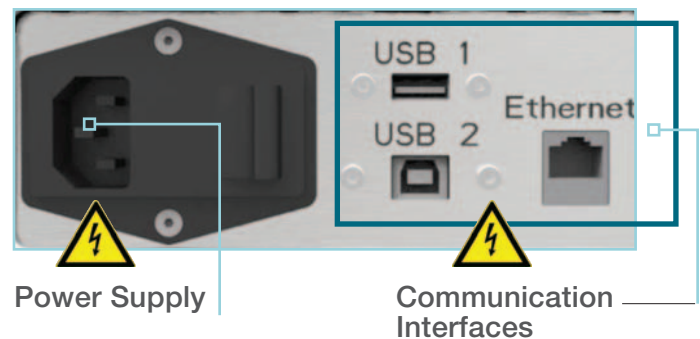
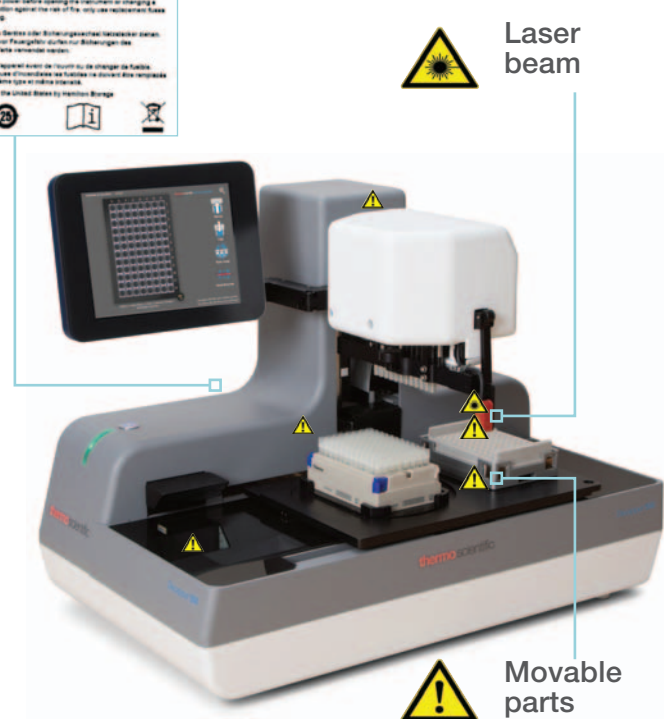

This page intentionally left blank



# 3 - Installation and Set-Up

These instructions allow operators to independently install the Decapper device

Check the instrument for possible delivery damages (glass damage).

## Shipment

According to your configuration of the Decapper device your delivery may consist of the following items:

- Instrument
- Head
- Adapter kit
- Cables

Figure 1: Sample content of Decapper Device

## Environmental Requirements

See in chapter General Instrument Specifications.

## Unpackaging and Placement



**Weight of instrument is about 20 kg**

Parts will move while the instrument is performing the initialization. Please do not place your hands on moving parts, this could lead to injuries.

The Decapper instrument and the Decapper head are delivered in separate boxes. When lifting the device out of the box, make sure to grab the device only at the designated areas in below to avoid mechanical damage of the instrument.

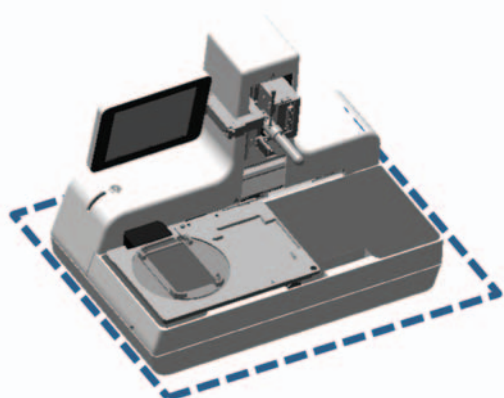

Figure 2: Grab underneath the instrument, where the dotted line indicates.



## Installation of Decapper Head

Make sure the Decapper Device is turned off while installing the Decapper head.

- a) Remove the safety pin.



b) Set the locking lever to unlock.

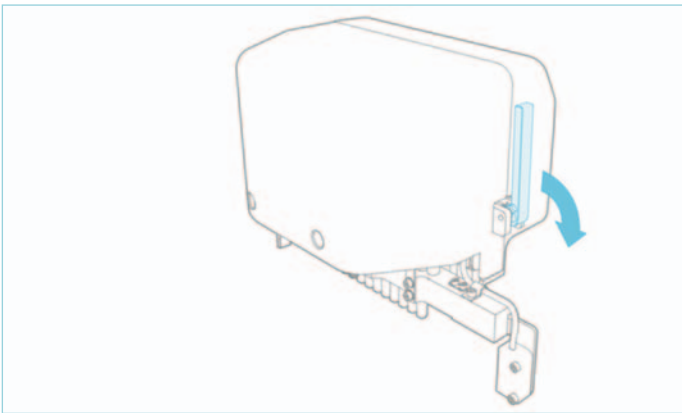

c) Install the Decapper head by moving it sideways onto the designated shaft on the Decapper device.

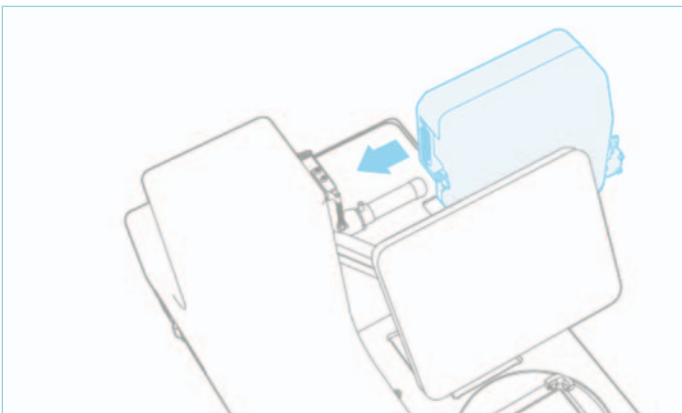

d) Make sure the Decapper head is firmly installed at its mechanical stop and the serial connection plug is mated.

e) Install the safety pin.

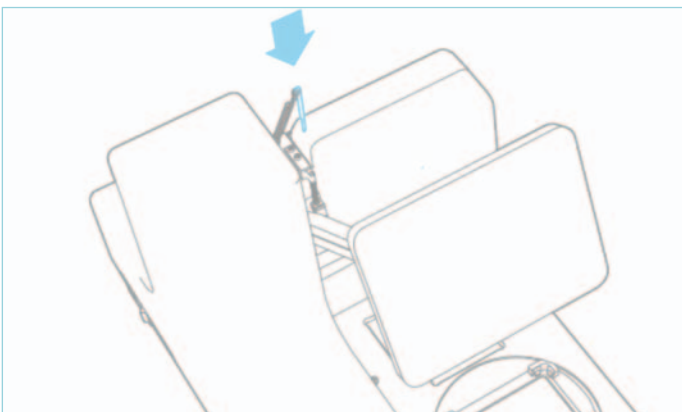

## Hardware Installation

### Connect the AC Line Cord and Power on the Device

Connect the AC line cord to the appropriate plug on the Decapper and press the power switch to turn the device on.

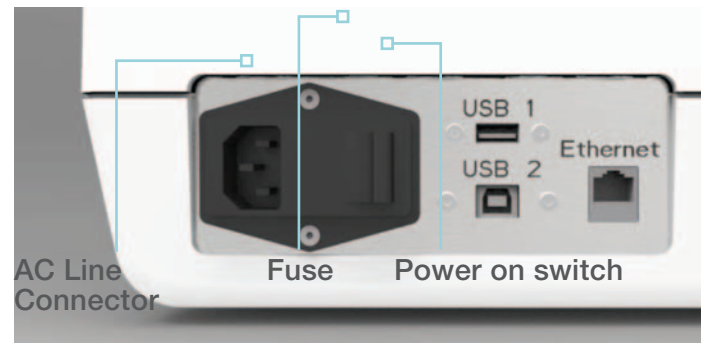

Figure 3: Decapper: AC Line Connector, Fuse and Switch



### Power connection

Connect only to an earth-grounded outlet and use the enclosed original Hamilton Storage power line cord.

Ensure easy access for unplugging the AC line cord.

## Display Orientation and Viewing Angle

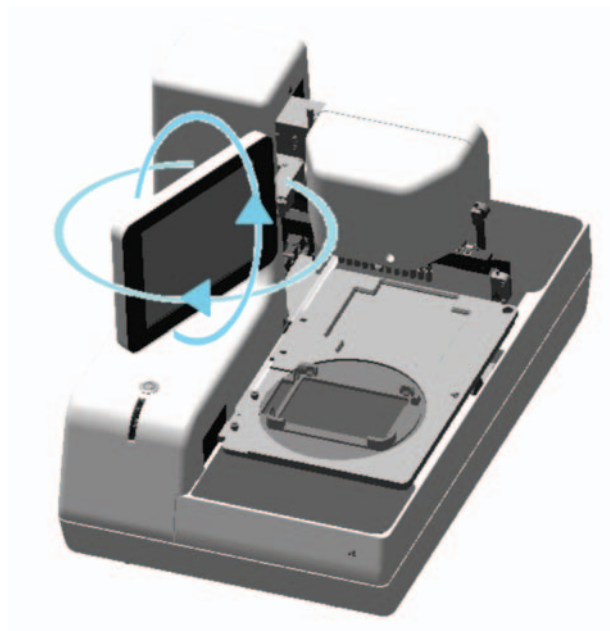

Figure 4: Display orientation

For optimal working comfort and contrast ratio on your viewing angle, the display can be positioned individually.

- Tilt display around the hinge
- Rotate display around the vertical axis by loosening the bolt in the back of the Display.

More display settings are available and described in section 3.1.7.

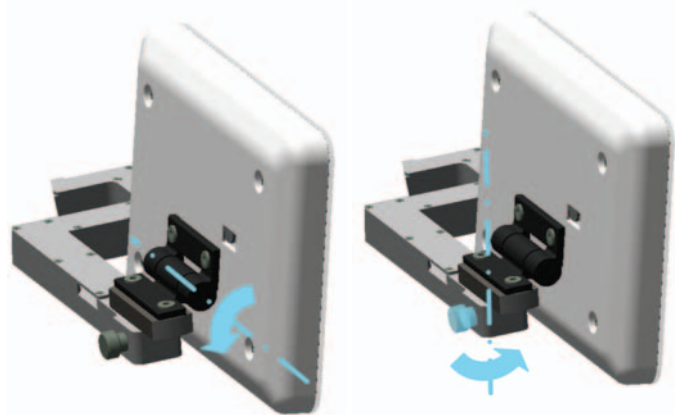

Figure 5: Display tilting axes

Put tube rack and cap holder at intended positions on movable stage.

## Installation of Labware Specific Adapters



**Moving parts could lead to injuries.**

To install or change Labware specific adapters, follow the instructions in the manual.

Different adapter types are necessary to process different tube racks. See selection table in appendix B to determine which adapter you require.



Figure 6: Sample of an adapter kit

To install a set of adaptors, perform the following functions:

To install a set of adaptors, perform the following functions:

1. Press the “Settings” button.



2. Press the “Labware” button. See Screen A



3. Cap Tray for Nunc Universal 1.8mL Tubes

4. Press the “Adapter” button.

*The Installation Guide will be displayed. If a change of Adapters is necessary, the device will lead you through the exchange procedure. Also see chapter Error! Reference source not found. See Screens B and C*



5. Press “Change” to proceed.

The screwer shafts will be presented.



6. Insert required adapter and push it into the shaft compressing the spring until it reaches the stop.

7. Turn the adapter 90° counter clockwise.

8. Let go of the adapter when it reaches its position.

9. Repeat the steps 6 to 8 until all adapters are installed..

10. Confirm with “OK” button.

The adapters are installed.

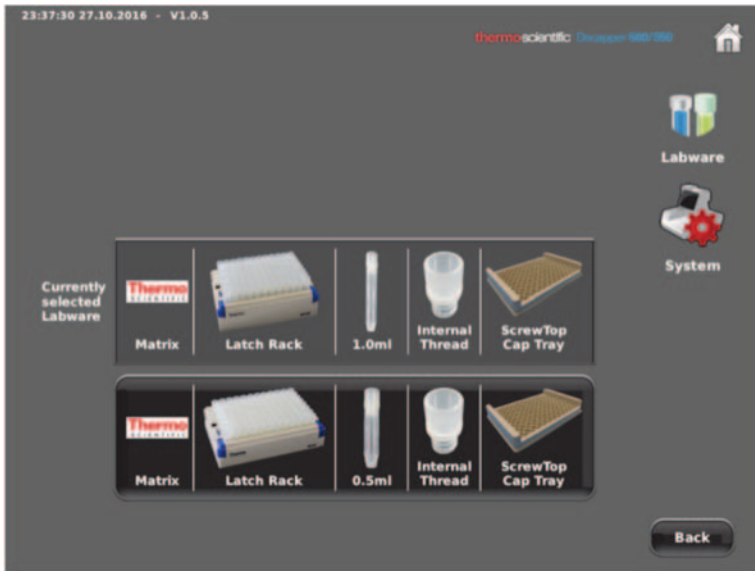

Screen A

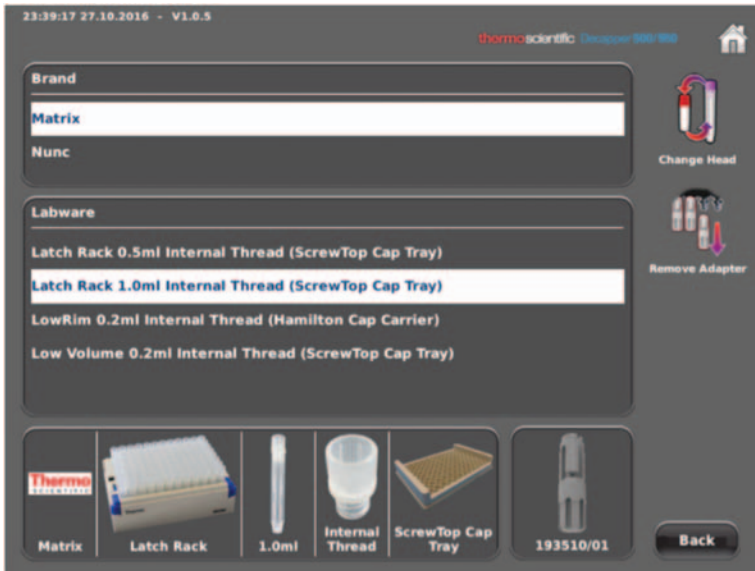

Screen B



Screen C

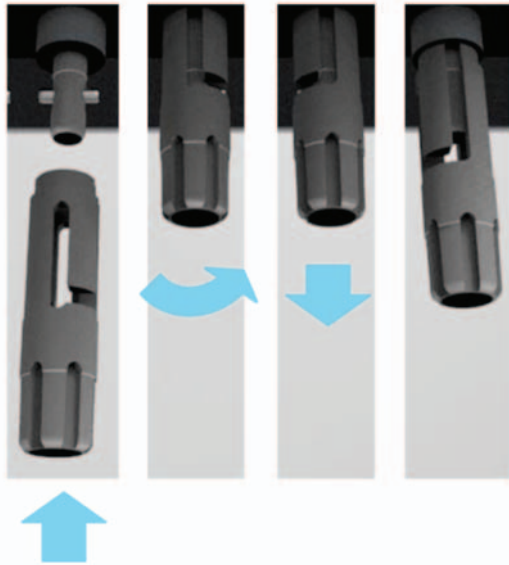

Figure 7: Installation of adapters, steps 6 to 8.

## Remove Labware Specific Adapters

To remove a set of adapters for processing of other tube formats or to clean, perform the following functions:

1. Remove tube rack and cap holder from the moving stage of the Decapper for convenient handling.

2. Press the "Settings" button.



3. Press the "Labware" button.



4. Choose labware brand, specific tube type, volume and cap carrier combination.

5. Press the "Change Adapter" button.  
*An Installation Guide will be displayed.*



6. Press "Change" to proceed.  
*The screwer shafts will be presented.*



7. Push the adapter into the shaft compressing the spring until it reaches the stop.

8. Turn the adapter 90° clockwise.

9. Pull the adapter down until it is released.

10. Repeat the steps 6 through 9 until all adapters are removed.

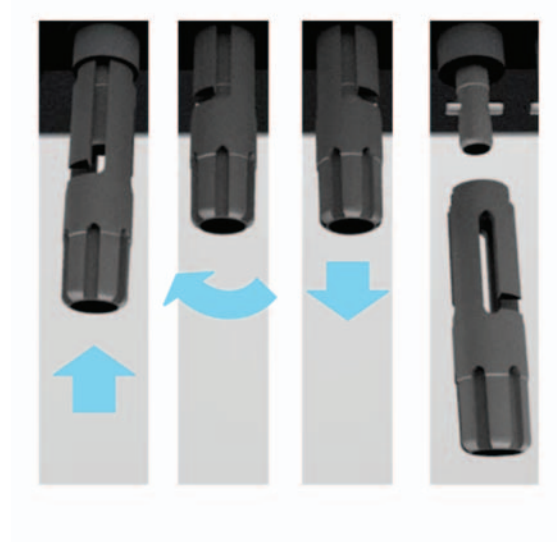

Figure 8: Removal of adapters, steps 6 to 9.

## Installation/Exchange of Tube Rack and Cap Holder



**Moving parts could lead to injuries.**

To install or change the cap holder, follow the instructions in the manual.



**Biohazard warning**

Deck and Cap Holder may contain bio-hazardous or chemically contaminated materials.

Put tube rack and cap holder at intended positions on movable stage.



**NOTE:** If the cap holder adapter is needed for your cap holder, first place the cap holder adapter in the cap holder position and place your cap holder on top of it. All cap holders, except for PN 4118-201, need the cap holder adapterblock underneath.

In order to avoid cross contamination it is recommended to replace disposable cap holders or autoclave the reusable cap holders after use.





Tube Rack

Figure 9: Position of tube rack and cap holder

## Settings

The Decapper device offers several options to customize its settings. This chapter will describe the different options for settings.

### Go to the settings menu:

1. Press the main "Settings" button.



2. Press the "System" button.



3. Press the "Settings" button.



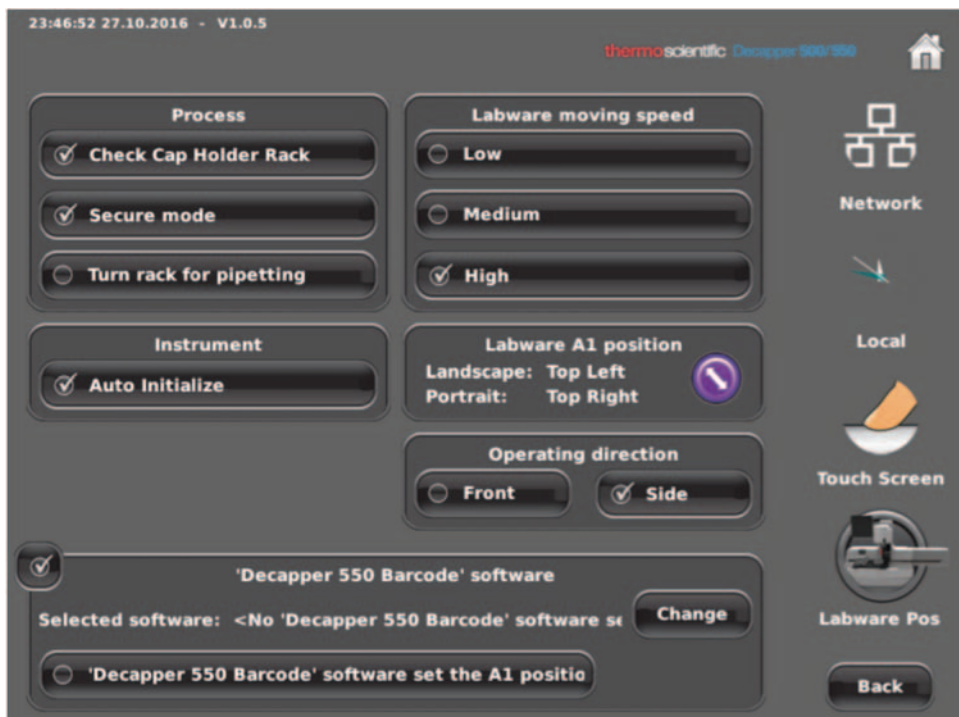

## Settings options

### a. Process

#### • Check Cap Holder Rack

Instrument checks if cap holder is oriented according to the tube rack orientation, i. e. landscape or portrait.

#### • Secure Mode

Recommended for all internal thread tube types, it minimizes cross threading by adding in a separate step to the capping portion of the labware script where all caps are slightly loosened to allow the threads to slip into place before being fully tightened down.

### b. Turn Rack For Pipetting

Turns the rack 90° when presenting it between decapping and capping of a row during the Row Loop processing.

### c. Instrument “Auto Initialize”

After powering the instrument on, at first operation the instrument will automatically perform an initialization. If box is unticked, a confirmation is

needed before initialization.

### d. Labware Moving Speed

Customize speed of the moving stage.

### e. Labware A1 position

Choose where A1 of the tube rack is positioned on the main screen.

### f. Operation direction

On the main screen, the orientation of the displayed rack will be adapted according to the operating direction set.

### g. Decapper 550 software (only available on the Decapper 550)

- Decapper software can be selected. (see also chapter 4.1.2 Connecting Decapper 550)
- Button “Decapper 550 Software set the A1 Position”

Set which Software determines the orientation of the rack during the the decoding tube codes process (see also chapter 4.1.2 Connecting Decapper 550).

## More Options

From the Settings Menu, there are some submenus available. They are listed and explained below:



### a) Network

- Configuration options (only needed for Decapper550, more detailed information in chapter 4.1.1)



- **VNC Client for download.**

With the VNC client the Decapper device can be operated from a PC. The Decapper graphical user interface (GUI) will be shown. Make sure the connection from the PC to the Decapper device is appropriate.

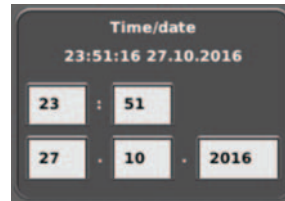

- Set Date/Time Format by ticking corresponding box.
- Confirm settings with "Apply settings" button.



- **c) Touch Screen .**

- Set display brightness by moving the bar.
- Calibrate display: Follow the instructions on the screen.



- **d) Labware Positions**

It is possible to save up to six customized Labware positions in the DeCapper and to import or export these positions for integration purposes.



### b) Date/Time

- Set date and time by clicking into the white fields.



This page intentionally left blank

# 4-Installation for Decapper 550

## Software Installation

Software installation is only necessary for the Decapper 550. To download the software please visit, [www.thermofisher.com/storagesoftware](http://www.thermofisher.com/storagesoftware)

## Computer Precautions

Guard against software viruses. Use only manufacturer's original installation CD-ROM sets for the operating system, and the original Thermo Scientific Decapper 550 software.



### CAUTION

Any manipulation of the Decapper 550 data files can result in erroneous reading results. Only the software may be used to control the Decapper 550.

## Installation procedure



### NOTE

Installation requests administrator access rights. See chapter 9.1.9 for PC requirements.

1. Insert the Software installation CD in the CD drive or download the latest software version at [www.thermofisher.com/storagesoftware](http://www.thermofisher.com/storagesoftware)

If installation doesn't start automatically start the program "Run autorun.bat"



2. The welcome screen of the setup wizard will appear and lead you through the installation.

3. During the installation, you will be offered to load the manual. (The manual can be opened at any time during operation from the Help menu.)



4. If there are already profiles defined, choose how to handle the new profile definitions included in the installation:

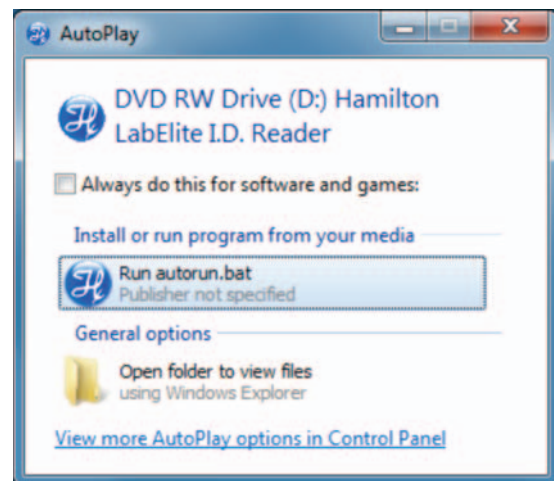

- If there are already rack definitions defined, choose how to handle the new rack definitions included in the installation:

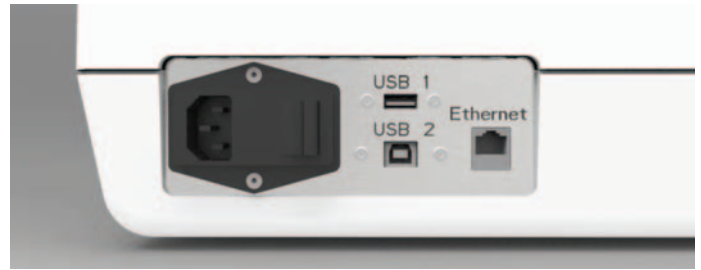

**CAUTION**

It is necessary to use USB 2.0!  
Lower USB versions will not work!

- Press “Finish” to complete the installation.



> System > Settings > Network

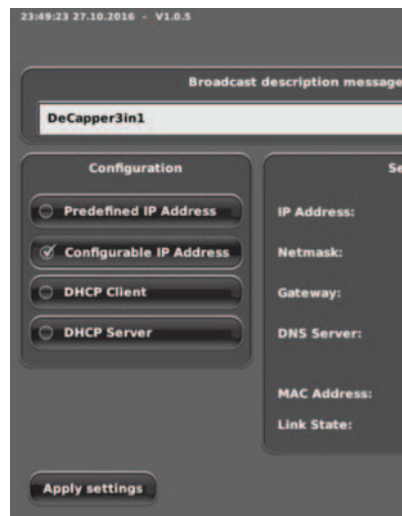

**Connecting Decapper 550 to your PC**

- Install Software on your PC as described in previous section.
- Start Software.



**NOTE**

Make sure that the software is installed before you connect the USB cable.

- Connect the Decapper 550 to your PC using the USB cable provided.
- Connect the Decapper 550 to your PC with an Ethernet cable as well.

In most cases DHCP Client will be ticked. If you are not sure about your network structure contact your IT support.

To confirm your selection press “Apply Settings”.

- Check on the main screen of the Decapper to see if “Read Barcode” button is available. If yes, go to step 7.



If the “Read Barcode” button is not available, go to:



> System > Settings > Network

and tick the “Decapper Software” box. The button will now be available on the main screen of the Decapper.

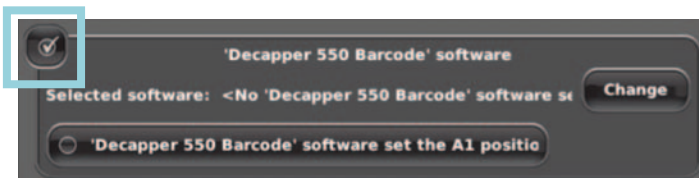

7. Define the PC/Software the Decapper 550 connects with. In the settings menu:



> System > Settings

Press the button “Change” to define the PC/Software that the Decapper 550 will be connected with. A list with PC names will be displayed for selection. After selection, confirm “OK”. If no list is shown, check if cable connection is correct and Software is started on PC.

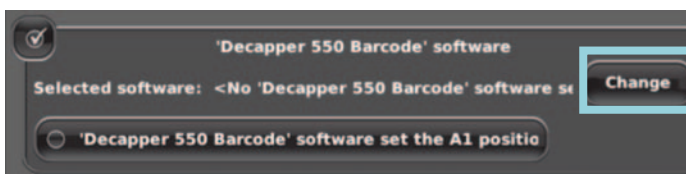

8. Choose whether Decapper 550 device or software determines the rack orientation, i.e. the position of A1:

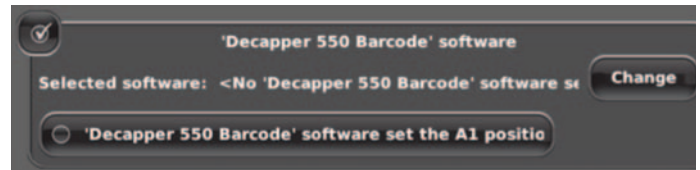

- If the box “Decapper software set the A1 position” is checked, then the rack orientation is defined in the Software profile definition. A deviation from the expected orientation to the orientation set on the Decapper 550 will not generate an error message! For data safety reasons and minimizing the risk of mishandling, this option is not recommended.
- If the box “Decapper software set the A1 position” is not checked:

The rack orientation set on the Decapper device (see also chapter 3.1.6, section e) is detected from the Software.

The settings in the Software profile and the setting on the Decapper 550 have to be identical otherwise an error message will be displayed. Code assignments to the corresponding tubes are safer in this mode.

See Chapter 6 for explanations of the profile definition.

9. Check on the main screen that the “Read Barcode” button is available and ready for processing. In the bottom right corner the current selected Software profile is displayed.



If there is a red X on the “Read Barcode” icon, there’s a connection problem between the Decapper 550 and the Software on your computer. Check cable connections, confirm that Software is started on PC, and if selected Software is correctly set as in step 8 above.

This page intentionally left blank

# 4-Operation

## Control and Indicators



### CAUTION

Please make sure that tube racks and installed adapters are in accordance with the selected labware type.

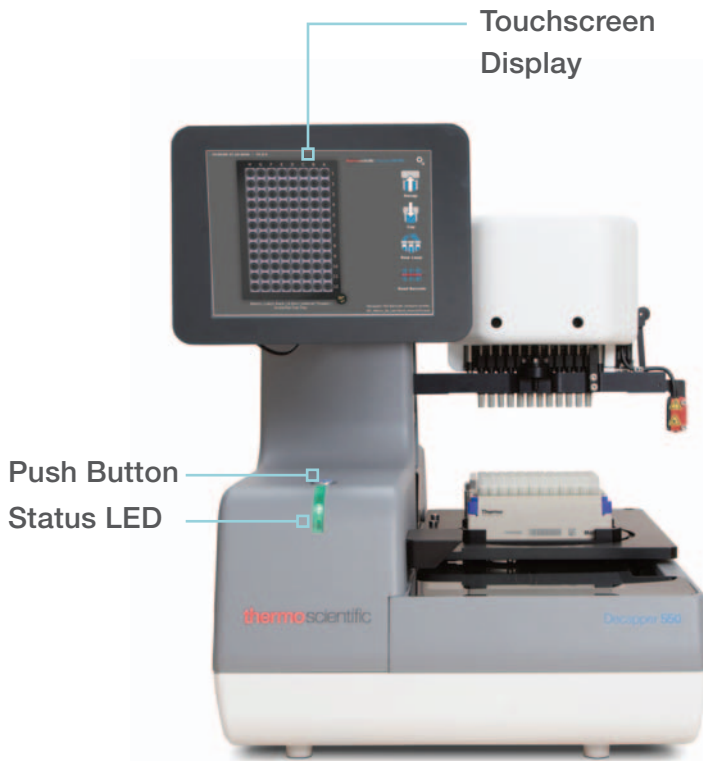

### Push button:

Indication	Meaning
Off	Device is not ready to scan and check
On	Device is ready to scan and check
Blinking	Scan and check in process

### Status LED:

Indication	Meaning
Off	Device is turned off.
Green	Device has finished last process successfully and is ready for a new process.
Red	Indication of error. Follow instructions on touchscreen.
Blinking green	Device is in process (decap/cap/row loop).

Blinking red - green      Device is starting up.

## Initialization

An initialization is performed as the first operation after powering the instrument on.



### NOTE

Be aware of moving parts during initialization.

## Selection of rows:

Rows can be selected in two ways:

- Single rows: press onto a row to select it. Press again to deselect.
- Whole rack: press for 1 second anywhere on the rack. Press again for 1 second to deselect all rows.

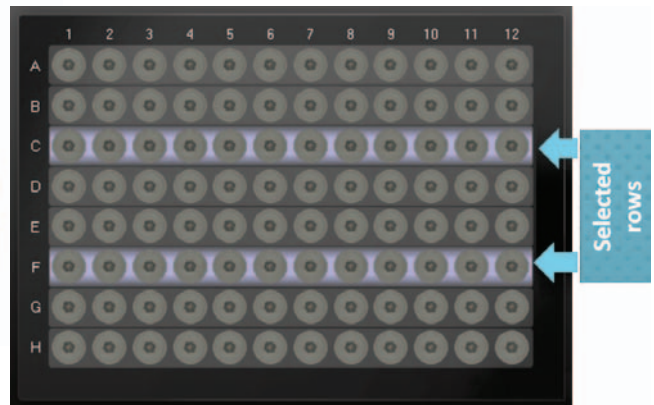

Figure 11: Selection of rows

## Decapping Tubes



### CAUTION

Prior to opening the screw cap tubes, a slight centrifugation could be beneficial, especially if the samples have been stored for a longer period and sublimation has led to frosting and sample residing on the cap or in the thread. Centrifugation can be performed at low G with a microplate rotor.



### NOTE

Processing can be paused at any time by pressing the "STOP" button.



1. Place a tube rack onto the tube rack position such that A1 of the tube rack is in accordance with A1 position on the display. (To change A1 position, see chapter 3.1.6 Settings options.)

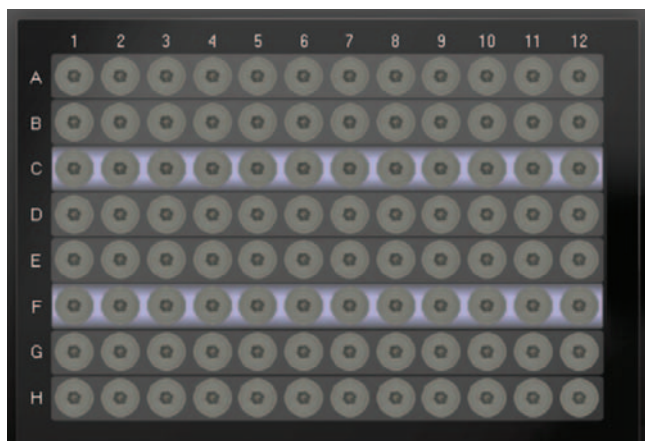

Figure 12: Label of tube positions

2. Place an empty cap holder in the cap holder position and use the Cap Holder Adapter, if necessary (see chapter 3.1.5 Installation/ Exchange of Tube Rack and Cap Holder)
3. Select rows to be processed.
4. The cap holder needs to be placed in the same orientation (portrait/landscape) as the tube rack will be processed.
5. Press the “Decap” button. Selected rows will be decapped.

## Capping Tubes



### CAUTION

Please make sure that either new caps or original caps are used to recap tubes. Be aware to place the cap carrier in the correct orientation, otherwise cross contamination may occur during capping the tubes.



### NOTE

Processing can be paused at any time by pressing the “STOP” button.

1. Place a rack with open tubes onto the tube rack position such that A1 of the tube rack is in accordance with A1 position on the display (see Figure 12: Label of tube positions). To change A1 position, see chapter 3.1.6 Settings options.
2. Place a cap holder rack with a correctly arranged number of caps in the cap holder position and use the Cap Holder Adapter Block if necessary.

The cap holder needs to be placed in the same orientation (portrait/landscape) as the tube rack will be processed.

3. Select rows to be processed.
4. Press the “Decap” button. Selected rows will be capped.

## Row Loop Mode

Once tubes are decapped, the caps are retained on the Decapper head (no placing of caps onto cap holders) while presenting the open row to the user for further processing. The caps remain on the Decapper Head until user is ready for the caps to be recapped back onto the tubes.

Adjust the display position such that handling (e.g. aliquoting) is convenient (see chapter 3.1.2 Display Orientation and Viewing Angle).

This loop mode is used to minimize cross contamination of the tubes by minimizing the time a tube is open and also by minimizing the amount of open tubes (e.g. for manual or automated liquid handling after decap followed by immediate capping).



### NOTE

Processing can be paused at any time by pressing the “STOP” button.

1. Place a tube rack onto the tube rack such that A1 of the tube rack is in accordance with A1 position on the display (see Figure 12: Label of tube positions).



### NOTE

No cap holder is needed in this mode.

2. Select rows to be processed.
3. Press the “Row Loop” button to start and follow the instructions on the touchscreen.

## Barcode Reading (Decapper 550 only)



### NOTE

2D barcodes on tubes will be decoded following former configured settings. Result file will be generated and can be exported via LIMS interface.



1. Select Labware Type (See chapter 0 Set Labware Type).
2. Place a tube rack onto the tube rack position.
3. Press the “Read Barcode” button on the main screen to start barcode reading based on the profiles, which have been previously configured in the Software.

## Using the Software The Main Window

The main window of the Decapper 550 Software is divided into four sections which will be explained in the following subchapters.

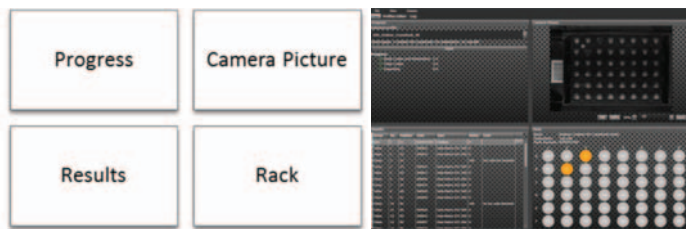

### Progress

The progress section gives an overview on the whole reading process.

- A profile can be selected from a drop down list.
- **Start** will initiate the reading of the tube rack.



- The duration of each step during the reading process is displayed in the lower section.



### Camera Picture

The camera picture shows the picture of the last tube rack that was read.



- Scroll inside the picture to magnify and see more details. With click-and-hold the picture can be shifted.
- Move the bar below the picture to change the magnification.
- The “Save...” button will store the picture.



### Results

The results window displays the complete list of all rack positions and their retrieved information.

- In case of unsuccessful reading an error code is listed





- Most common errors:

- **No bar code detected:** It was not possible to detect anything that looks similar to a code. The position is either empty or occupied with a tube that has no code.

- **Bar code not decoded:** A code structure was detected, but it was not possible to get any information out of it. The code may be damaged or partly covered.

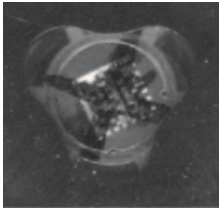

A defect datacode on a cryotube

- **Wrong bar code mask.** The code was present and readable, but does not fit to the specified bar code mask.

A complete list of all error codes is available in the appendix.

Group	No.	Position	Code	Type	Status	Error
Side	1	A1	D5655722D	Codabar	0	
Tubes	1	A1	X00061	Data Matrix ECC 200	0	
Tubes	2	A2	X00012	Data Matrix ECC 200	0	
Tubes	3	A3			104	Bar code not decoded
Tubes	4	A4	X00014	Data Matrix ECC 200	0	
Tubes	5	A5	X00017	Data Matrix ECC 200	0	
Tubes	6	A6	X00046	Data Matrix ECC 200	0	
Tubes	7	A7	X00073	Data Matrix ECC 200	0	
Tubes	8	A8	X00030	Data Matrix ECC 200	0	
Tubes	9	B1	X00003	Data Matrix ECC 200	0	
Tubes	10	B2			106	No bar code detected
Tubes	11	B3	X00026	Data Matrix ECC 200	0	
Tubes	12	B4	X00041	Data Matrix ECC 200	0	
Tubes	13	B5	X00007	Data Matrix ECC 200	0	
Tubes	14	B6	X00010	Data Matrix ECC 200	0	
Tubes	15	B7	X00002	Data Matrix ECC 200	0	
Tubes	16	B8	X00008	Data Matrix ECC 200	0	
Tubes	17	C1	X00009	Data Matrix ECC 200	0	
Tubes	18	C2	X00042	Data Matrix ECC 200	0	

Fig. 1 The Results table

## Rack



The Rack window shows the complete array of the tube rack and the status of each code after decoding.

Green: Code successfully decoded

Grey: No code detected, i.e. no tube present or bad code quality

Red: A problem has occurred during decoding.

Check the results table. A list of error codes is in chapter 0 G. Error codes.

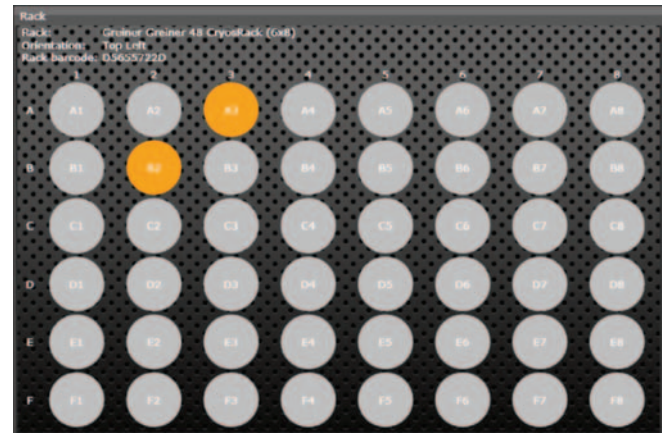

Fig. 2 Results in the Rack Window

# 6-Creating a Profile in the Decapper 550 Software

## The concept of profiles

A profile contains all information that is needed to perform the complete reading process. It defines:

- Rack type
- Procedure of processing
- Output data

A profile is based on the process and therefore related to the user that is handling the process. A profile is not necessarily based on the rack types to decode. The profile concept allows e.g. two different users to decode the same rack type with different settings for the output files.

An active profile is required to run a decoding process with the software. The software is delivered with sample profiles that can be used for testing and training purpose.

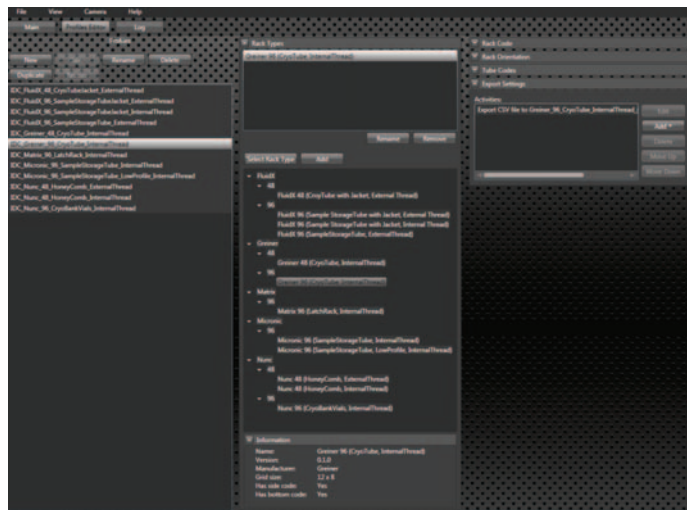

Fig. 3 Overview of the profile editor

New rack types can be imported using the “Import Packages” button in the “File” menu.

## Five simple steps to create a profile

### Step one – Create a profile

Profiles can be created or edited in the “Profiles” section of the Profile Editor window. The below listed commands are available:

- **New** Create a profile
- **Save** Save changes to your profile
- **Delete** Delete a profile
- **Rename** Rename an existing profile
- **Restore** Undo the changes and set the profile back to the last stored status.
- **Duplicate** Duplicate an existing profile

A profile with unsaved changes is marked with a \*. Only when an unsaved profile is present the commands “Save” and “Restore” are active.

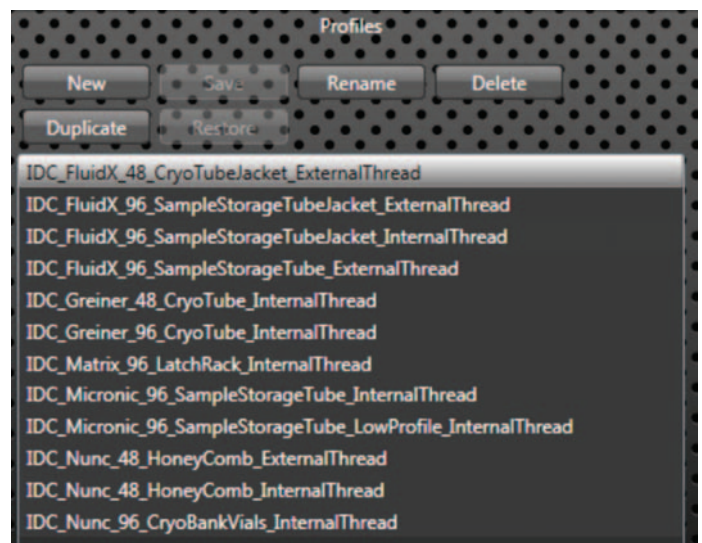

Fig. 4 Profiles

## Step two – Choose a rack type

Make sure the new profile in the “Profiles” section is selected. Then choose the rack type of your tube from the list in the “Rack Types” section. The available tube racks are sorted by:

- Brand, e.g. Matrix, Nunc
- Format: Size of the array, e.g. 48, 96
- Name of the rack

Use **Add** or a doubleclick to include the racktype to your profile. When a rack type is added to your profile it will be listed above.

**Remove** will delete this racktype from your profile

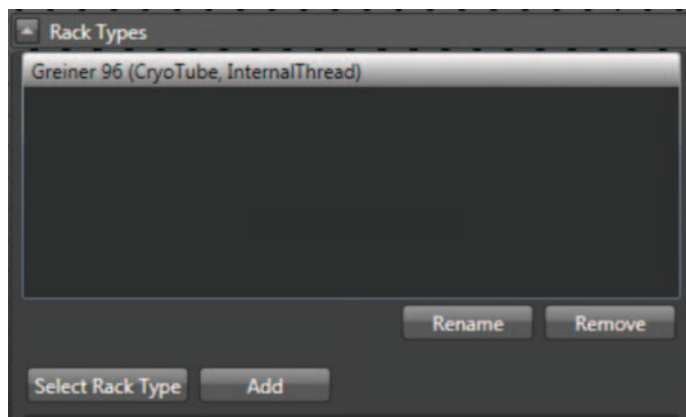

Fig. 5 Rack types

## Step three – Determination of the tube rack’s identity

There are two common ways to identify a rack: the bottom code and the side code. The bottom code is a 2D Datamatrix code which is printed onto bottom side of the rack. The side code is most often a 1D code on the side of the rack. In chapter 9.1.14 the requirements specification for the rack code are listed.



### NOTE

With the Decapper 550, reading of the side code is only available after purchasing

## a) Rack Code

The Rack Code can be defined as side or bottom code or both:



1. Define whether side or bottom code or both will be identified and enable the corresponding section by ticking the “Enable code detection” box.

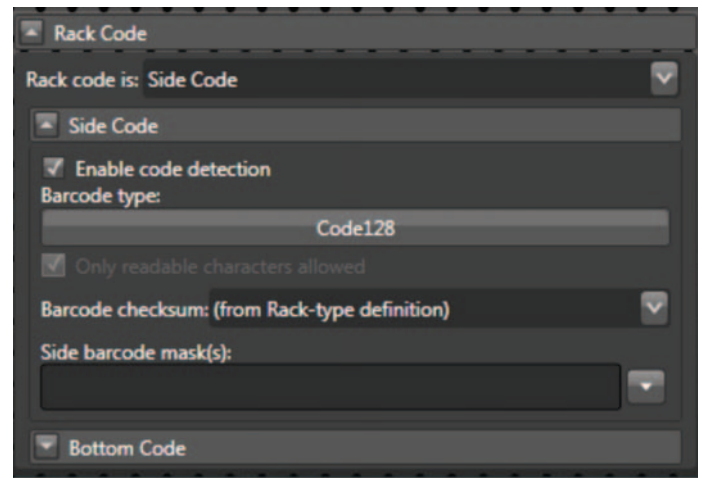

Fig. 6 Rack code

2. Define the code type by checking the regarding boxes in the dropdown list “Barcode Type”. Selection of multiple code types is possible, though not recommended.
3. Set handling of Barcode checksum  
The usage of the check sum of the bar code can be switched on or off. The handling of the check sum can also be determined by the rack type definition, which is recommended, since not all bar code types offer a check sum.
4. Set a barcode mask  
It is highly recommended to use a bar code mask that contains the elements present in all codes of your batch or at least the length of the code. Bar code masks are explained in 0. F.Set bar code mask

## Step four – Set the rack orientation detection

The rack orientation setting options are different when using a Decapper 500 and a Decapper 550. Please read this chapter carefully.



### NOTE

When using an I.D. Capper or I.D. Capper integrated, please consult the Manual of the LabElite DeCapper Instruments PN 624701 for further information about settings

To get a proper assignment of the decoded tubes to their position in the rack, the orientation of the A1 position must be known. The Decapper 550 can automatically detect the orientation of the rack with several methods.

The terms “A1 top left” and “A1 bottom right” are used to distinguish between the orientations.

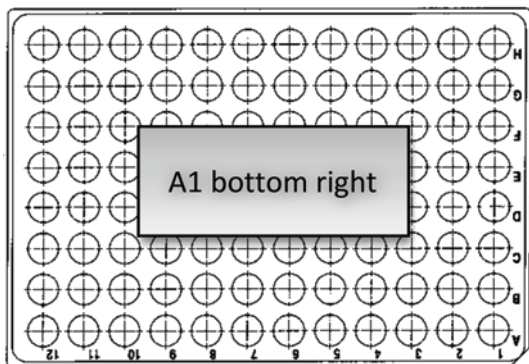
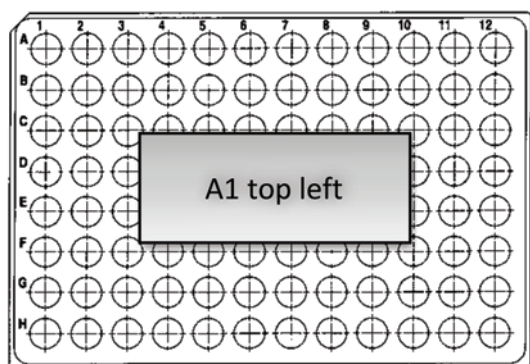

The following selection is available:

- Fix orientation: User sets how racks will be placed into the reading device. A1 is either top left or bottom right
- Side code: The side code of some rack types can be used for automatic detection of the rack orientation. The orientation of the rack is

determined by referring to the side code, because A1 and the side code have a fix correlation to each other in one rack type.

- Bottom code: The bottom rack code of some rack types can be used for automatic detection of the orientation. The orientation of the rack is determined by referring to the bottom codes position, because A1 and the bottom code have a fix correlation to each other in one rack type.

Error recovery (for Decapper 550 only): If the selected detection fails, a second detection method can be used as error recovery.

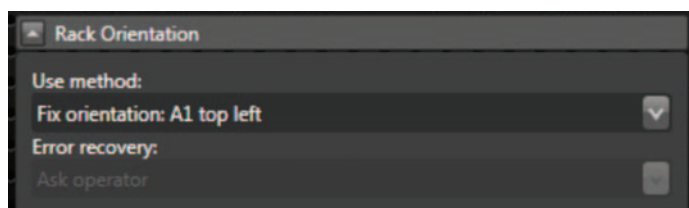

Fig. 7 Rack orientation



### CAUTION

If option a.) Fix orientation is chosen; the user is responsible for the correct assignment of the codes to their position in the rack. If the orientation of the rack is different to the setting, this will lead to wrong results!

## 6.1.5 Step five – Export settings

The results can be exported either to different formats:

- CSV
- XML

1. To add a new export procedure press the “Add” button and choose the file format



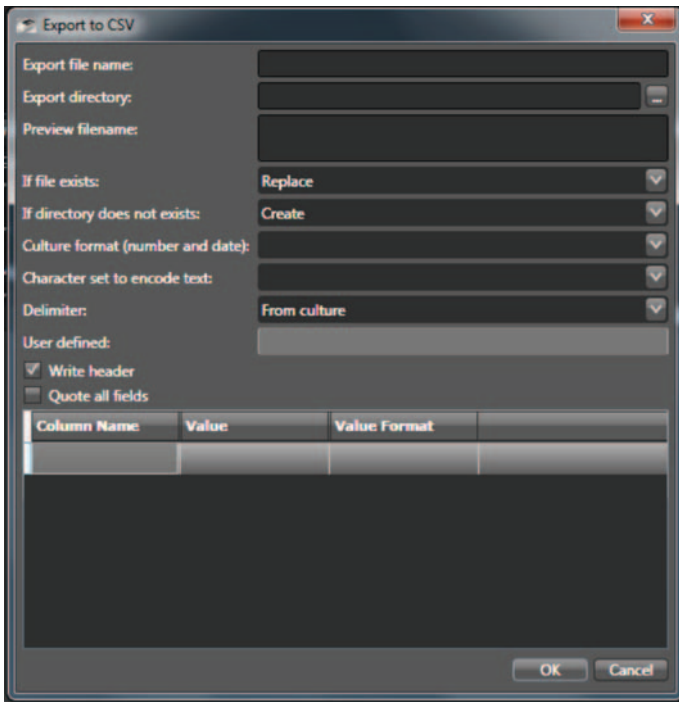

2. Define an export name.

The structure of the output file name can be generated automatically of the output file can be automatically using place holders. A preview of the filename will be displayed. A selection of the most common place holders is listed below:

- {RackCode}: Side barcode or bottom code depending on the choice in the profile
- {DateTime}: Date and time, format is dependent on “culture settings” of Windows
- {DateTime:yyyyMMddHHmmss}: Date and time, format is defined after colon
- {Date}: Date in a fixed format e.g.: 20140901. Equivalent to {DateTime:yyyyMMdd}
- {Time}: Time in a fixed format e.g.: 105901. Equivalent to {DateTime:HHmmss}

3. Define an export directory.

4. In case the file exists already or the directory does not exist, you have different options to handle it.

**Additional options for CSV files**

- Specific culture formats, character sets (ANSI,

UTF-8, Unicode, ASCII) and delimiters to separate the values can be set from the dropdown list.

- To write a header above each column, tick the corresponding box and define the value and column name.

By clicking in an empty “Value” field the choice of data possible to list in the file, will be shown in the dropdown list. Each value chosen will be added as a column to the result table. The default names of the columns are the names of the chosen data type, but they can be modified as well.

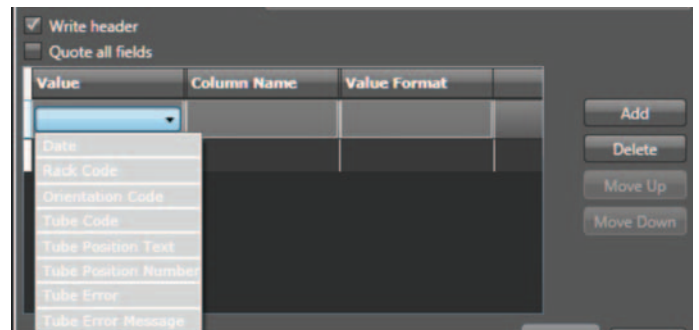

- If the box “quote all fields” is ticked, then all values set in quotation marks.

# 7-Update and Labware Installation

## Software Update

1. Get the Software update package or a particular labware script file from Thermo Fisher's web page (information also found on software index card included with shipment).

[www.thermofisher.com/storagesoftware](http://www.thermofisher.com/storagesoftware)

2. Copy the \*.tar.gz file (software update) onto the top level of a USB drive (no subfolders).

3. From the Home Screen go to:



> **System** > **Service** > **Update**

Insert the USB stick to USB 1. The stick will be scanned for updated files.

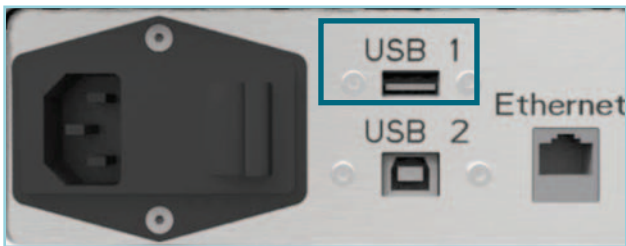

5. Choose the software update package from the list, press the "Update" button and follow the instructions on the screen.

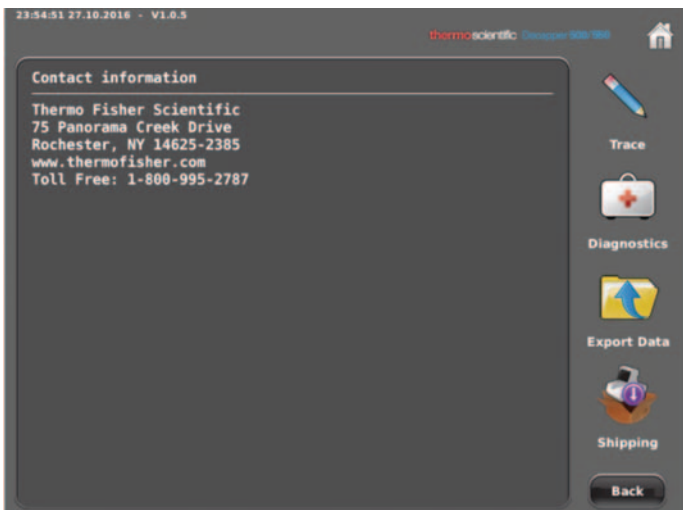

6. After the update remove the USB drive and reboot the device

This page intentionally left blank

# 8-Service and Error Handling

In addition to explaining the service menu, some typical troubleshoot procedures are given provided in this section including: How to proceed in case of an incident, and where to get support.

## The Service Menu

### Go to Service Menu:

1. Press the "Settings" button.



2. Press the "System" button.



3. Press the "Service" button.



The Service Menu contains 4 submenus which are explained in the following sections:

- Adjust
- About
- Update
- Advanced

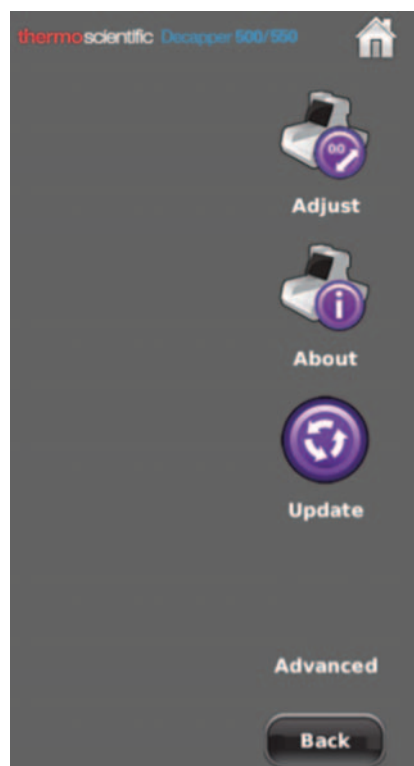

## Adjust



### CAUTION

For adjust you need:

- Cap Holder Adapter Block (stainless steel)
- To remove Labware and Cap Holder from deck

In case of a malfunctioning device, always perform an adjustment procedure.

1. Go to the service menu and press "Adjust" button and confirm with "Adjust". During the adjustment procedure, follow the instructions on the screen. (see Figure D)
2. After the adjustment has finished successfully, your device is ready for use again.
3. Verify the instrument's functionality by processing a tube rack.



### NOTE

If the adjustment procedure failed, perform a diagnostic as described in chapter 8.1.2.

## About

Four submenus are available and explained in the following sections.

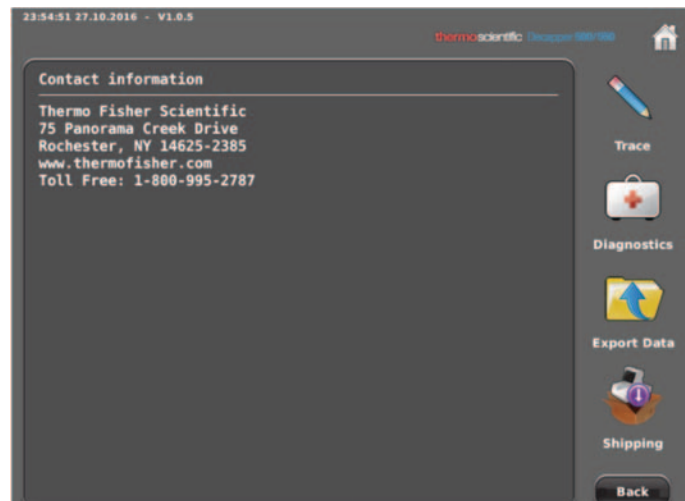

- a) **Trace** The latest actions reported in the trace file are shown in the window.
- b) **Diagnostics** If instrument is not working properly, the diagnostics gives more information about possible problems.





**CAUTION**

- Before starting the diagnostics please execute adjust. See chapter 8.1.1 Adjust.

**From the Home Screen go to**

1. System > Service > About



2. Press "Diagnostics" button and follow the instructions on the screen.



**NOTE**

If the diagnostics pass without an error but the instrument is still not working properly the problem can not be detected automatically. Please contact Thermo Fisher Technical Support.

**c) Export Data** If you need assistance from Thermo Fisher Technical Support the diagnostics data is necessary for first analysis.

**From the Home Screen go to**

1. System > Service > About



2. Press "Export Data", to save diagnostic onto a USB stick.



3. Insert a memory stick to USB 1 and Diagnostics data export starts automatically. See Figure E

4. Send the Diagnostics Data (zip file) from memory stick to Thermo Fisher Technical Support.



**d) Shipping** When this button is pressed, the device will be prepared for shipping. Axes will move to shipping positions. See Appendix C for how to remove the decapper head and packing instructions.

**Update**

This section is described in chapter 7 Update

**Advanced**

This section is password protected and accessible by Thermo Fisher personnel only.

# What to Do in Case of an Error

There is a basic procedure Thermo Fisher will following in the case of an unexpected error:

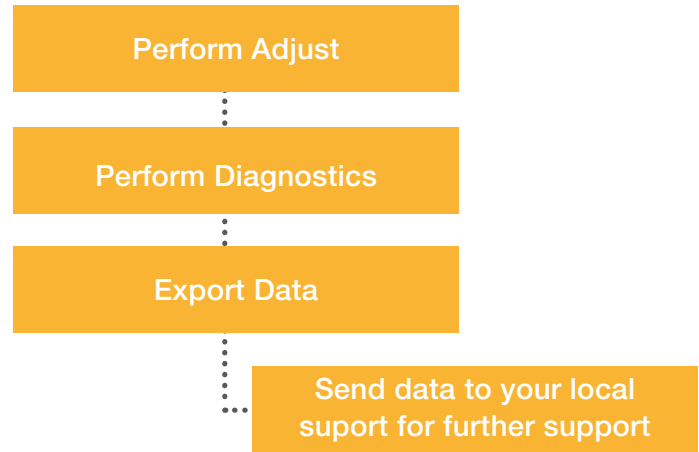

# 9-Technical Specifications

## General Instrument Specifications

Dimensions	
Instrument dimensions	Width: 374mm
	Height: 451.5mm
	Depth: 600mm
Weight	
Instrument weight	Weight: 20kg
Head weight	Weight: 2.5kg
Power Supply	
Voltage	110VAC and 230VAC, voltage fluctuation $\leq \pm 10\%$
Frequency	50/60Hz $\pm 5\%$
Maximum Power Consumption	200VA
Fuse	Miniature Fuse, 4A, 5 x 20mm, Time-Lag T, L, 250VAC
Operating Environment	
Temperature Range	15°C to 35°C
Relative Humidity	30% to 85% (no condensation)
Altitude	Up to 2000m above sea level
Overvoltage Category	II
Pollution Degree	2
Noise Level	< 62 dBA (regarding EN27779)
Usage	Indoor use only
Storage and Transportation	
Temperature Range	-20°C to +55°C
Relative Humidity Range	30% to 85% (no condensation)

## USB Communication (IDecapper 550 only)

On Decapper 550 USB communication to Host PC is required.

Standard	USB 2.0
Current over USB	<500mA
Connector	Typ B ( 3m USB 2.0 cable "A" Plug to "B" Plug included)

## USB Communication with Memory Stick (optional)

For Software updates, USB communication to Memory Stick is required.

Standard	USB 2.0
Current over USB	<500mA
Connector	Typ A

## Ethernet Communication to Host (optional)

If the device is integrated into a larger automation solution and controlled by host, Ethernet communication is required. For further details on this connection, please contact your local Thermo Fisher sales representative.

Standard	Ethernet 10/100BaseT
Current over USB	Typ RJ45

## PC Requirements



**NOTE**  
PC is not included

Recommended PC	2.8 GHz Core 2 Duo, 8GB RAM, 250GBHD, 16x DVD+/-RW Windows 7 (64 bit)
Communication	two USB 2.0 ports

## Compliance with Regulatory Requirements

Thermo Fisher supplies a 'Declaration of Conformity' and a 'Declaration of Quality' for each Decapper.

This documentation is to be kept on file by the user.

## Instrument Life Cycle

<b>Instrument Life Cycle</b>	The instrument is designed for a life cycle of 6 years
------------------------------	--

## Compatible Bar codes for Decapper 550

### Barcode Reader

<b>Suitable Racks</b>	All ANSI Racks, with 12, 24, 48, 96, 384 tubes
<b>Tube Manufacturers</b>	Matrix, FluidX, Micronic, Corning, Abgene, Nunc, Greiner, Axygen, Remp, Hamilton
<b>Supported 1D codes</b>	2/5 Industrial / Interleaved, Code 39, Code 128, Pharmacode, Codabar, EAN 13 and many more
<b>Supported 2D codes</b>	Datamatrix ECC 200

### Positioning of the side code labels

The plate barcode must fit only on side A or on side B of the rack.

The barcode must be positioned in the middle of the rack.

The barcode label must not protrude above or below the edge of the rack.

The barcode label must be placed within a height of 18 mm from the bottom of the rack

The barcode label must be parallel to the edge of the rack.

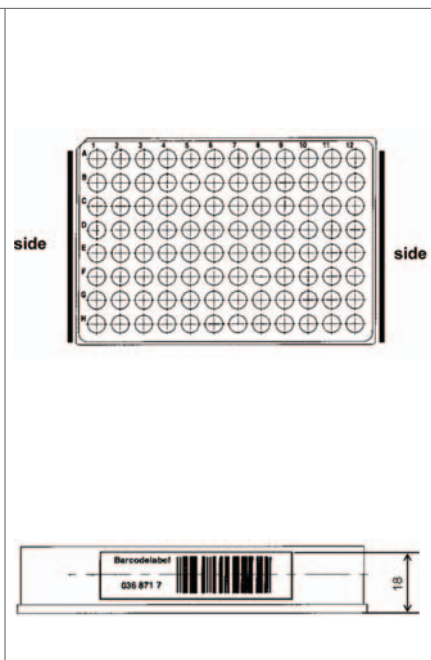

## Rack size codes

<b>Label Specification</b> The barcode should be centered on the tube rack				
	Dimension		Min	Max
	A	Label length	-	66mm
	B	Code length	-	30mm
	C	Quiet zone	-	66mm
	D	Label width	-	-
	E	Code width	-	-
		Distance from code to label edge (if necessary)	-	1mm
	Label area on the rack (from bottom)	-	18mm	

# 10-Appendix

## A Glossary

### Head

The Decapper head allows processing of Thermo Scientific tubes in both 96 and 48 format racks.

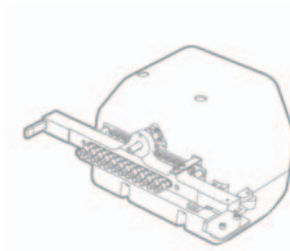

### Adapter kit with adapters

The Adapter kit contains the tube cap specific adapter, that can be installed on the head.



### Cap holder

The cap holder is a carrier where caps are stored when tubes have been decapped. It is autoclavable or disposable. See list in Appendix Section B for correct configuration.



### Stage

The stage contains tube rack and capholder position.

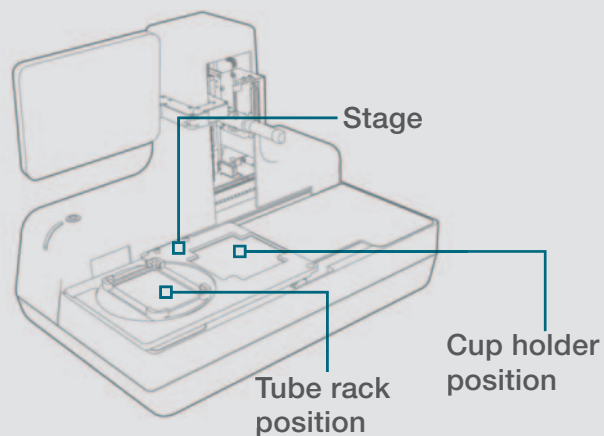

### Cap Holder Adapter Block / Adjustment Block

This part is used for all capholders as an adapter and for the adjustment procedure. It is placed in the cap holder position of the stage.

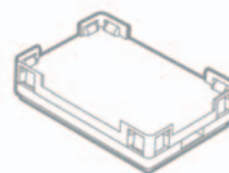

## B Configuration Selection Table

Tubes	Adapter Kit	Cap Tray
Thermo Scientific Matrix Screwtop Tubes 0.5mL	4118-101	4906
Thermo Scientific Matrix Screwtop Tubes 1.0mL	4118-101	4906
Thermo Scientific Matrix 200uL Screwtop Tube	4118-102	4118-201
Thermo Scientific Nunc Cryobank Tubes 0.5mL and 1.0mL	4118-103	4118-201
Thermo Scientific Nunc Cryobank 2mL Tubes	4118-104	4118-203
Thermo Scientific Nunc Universal 2mL Tubes	4118-104	4118-203
Thermo Scientific Nunc Universal 1.8mL Tubes	4118-104	4118-202

## C Packing

For shipment of the Decapper 500 and Decapper 550, use original boxes for device and head.

### 1. Device preparation

Before the device is packed, all axes have to be moved to shipping position. See chapter 8.1.2 About, section d) for instructions.

2. When all axes are in shipping position, turn off the instrument and then remove the Decapper head.



a) Go to Change Head Menu. Press the “Settings” button.



Press the “Labware” button



Press the “Change Head” button

The Installation Guide to scroll through is displayed.



Press change to proceed

b. Turn off the device.

c. Remove safety pin.

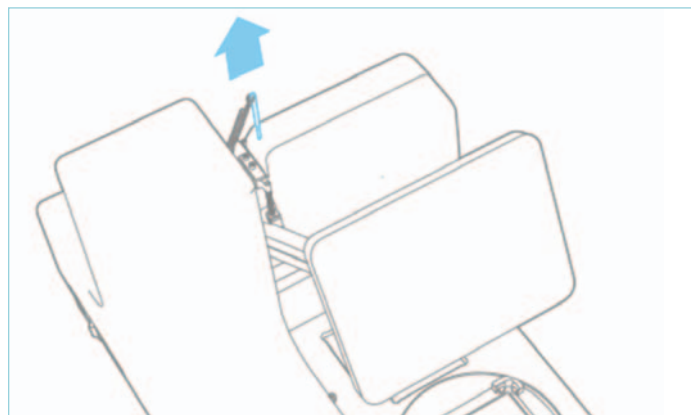

d. Lift lever on the right side of the Decapper Head. It will loosen from the plug.



#### CAUTION

Never lift lever without unplugging the safety pin!

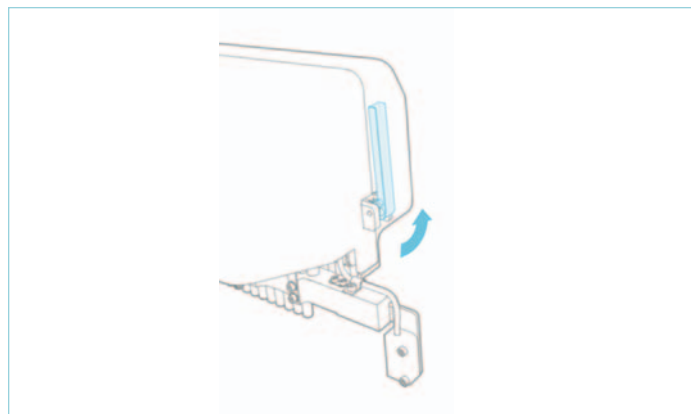

e. Remove Decapper Head by moving it sideways.

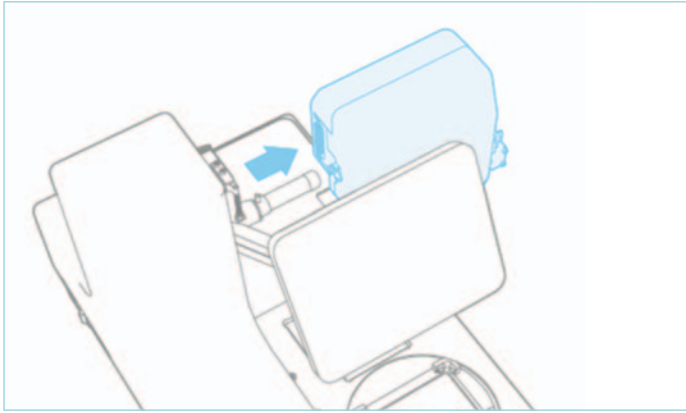

f. Store the Decapper Head in its original packing.



**CAUTION**  
Fragile parts.

- Pack the head into its designated box, as the picture below shows.

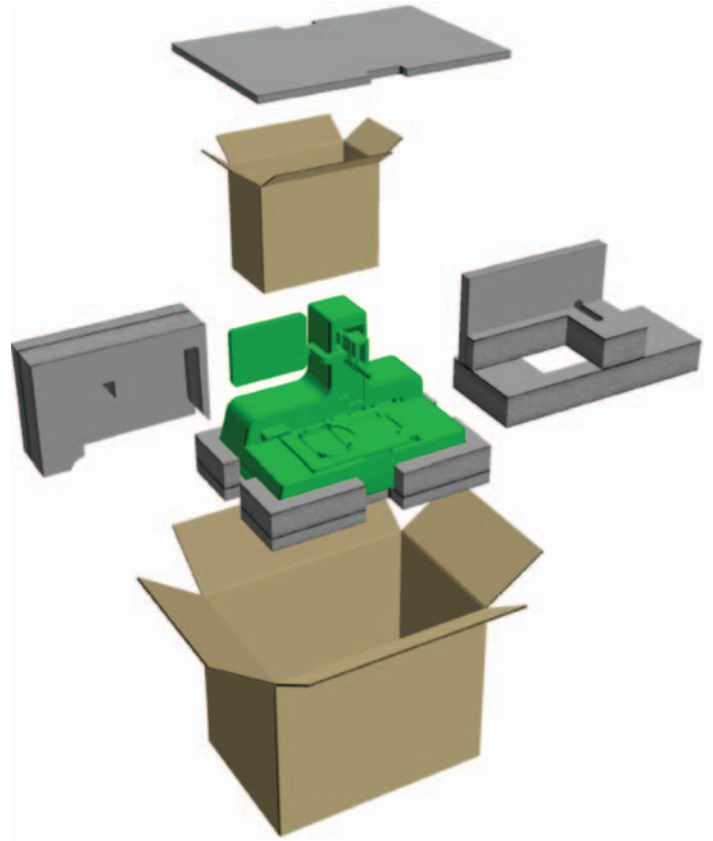
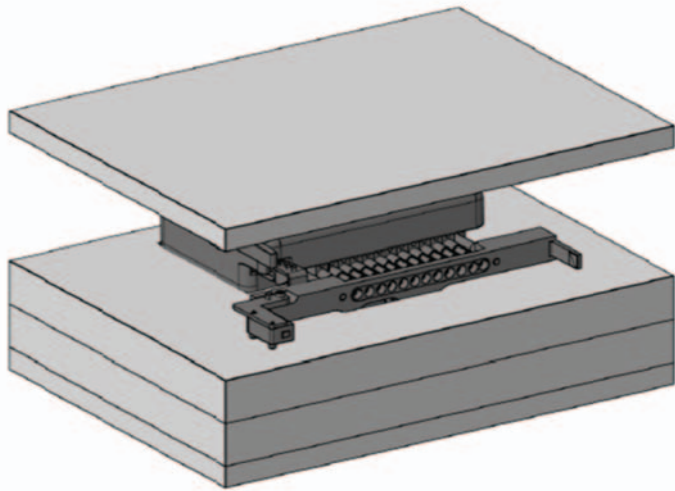

Box for accessories

Space for one Head-box

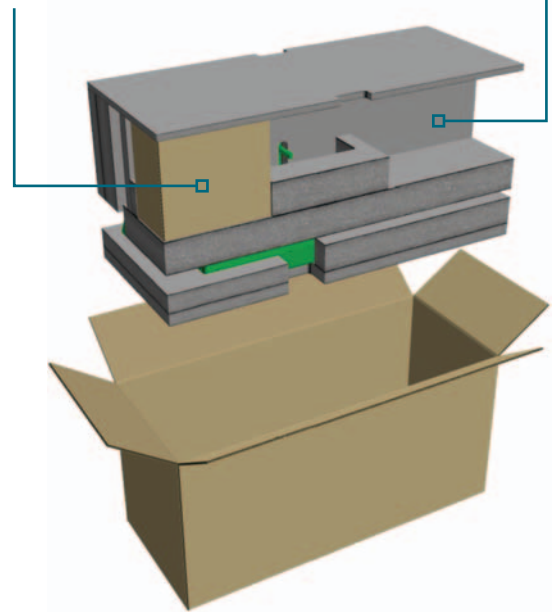

3. Remove all objects from the stage, unplug the cables. All accessories go into a separate box, which is included in the original packing equipment.
4. Pack the instrument according to the following pictures below.

## D Decapper 550 Software Glossary

Side code: Rack code place on the short side of a rack. It can be 1D or 2D

Bottom code: Rack code placed on the bottom of the rack. It is 2D

Tube Code: Each tube in a rack has a tube code.

## E. Import new packages in Decapper 550 Software

For new tube racks, settings packages can be imported. The file type to import has the format “.idrackpkg”. The import is done with the following steps:

1. Go to the “Profiles Editor” window and press “Import” in the “Rack types” section.
2. Press “package” and determine the file to be imported. A description of the rack type is displayed.
3. Press “Import/Update”

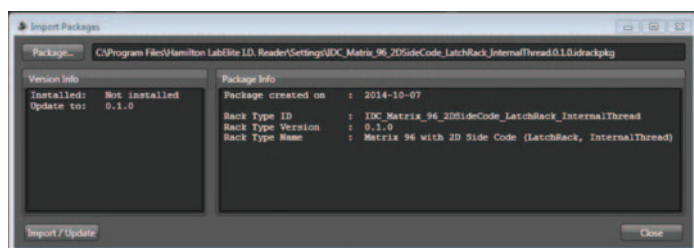

## F. Set bar code mask

With a bar code mask, an expected pattern of the read codes is defined. All decoded codes that do not match the pattern in the barcode mask will produce an error. This is a helpful feature to make sure no bar codes from a wrong batch will be read by mistake. Both, bottom and tube codes can be filtered using a barcode mask.

It is highly recommended to use a barcode mask for the side code to avoid misreadings of code types without check numbers. A yellow bar will indicate the recommendation

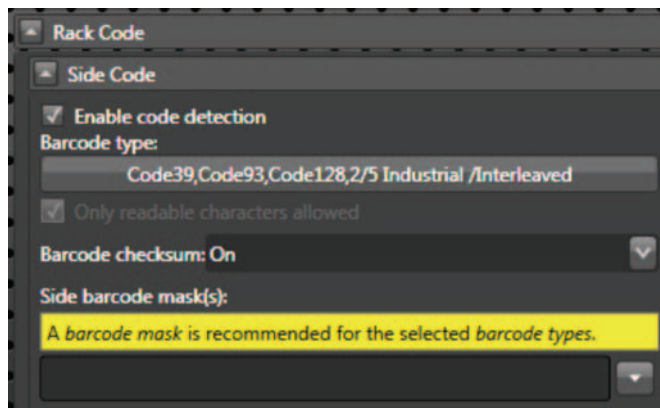

More than one mask can be entered in a profile. To test your mask you can select “Test mask” from the drop down list and select an array of read codes.

The patterns are entered using place holders. They can be selected from the dropdown list:

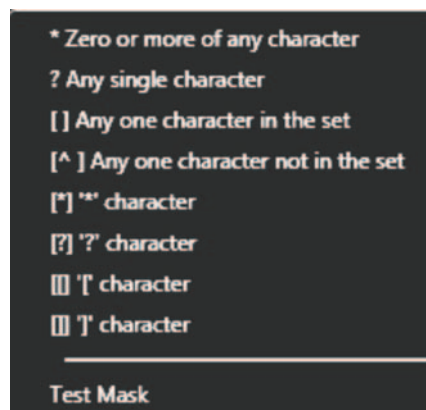



A detailed explanation of the place holders is listed in the table below:

Place holder	Explanation	Example	Successful matches	Unsuccessful matches
*	Place holder for none or any amount of characters	*45*	45 <b>6789</b> 12 <b>3456</b> 34 <b>5678</b>	654321 123467
?	Place holder for one character	12345?	1234 <b>56</b> 1234 <b>57</b> 1234 <b>58</b>	1234567 23456
[]	Place holder for one character which has to match with one from the set in brackets	12[abc]345	12 <b>a</b> 3456 12 <b>b</b> 3456 12 <b>c</b> 3456	12abc345 12d3456 123456
[^]	Place holder for one character which must not match with one from the set in brackets	12[^abc]345	12 <b>d</b> 345 12 <b>2</b> 345 12_345	12a3456 12b3456 12c3456
Use of place holders as mask characters in code				
[*]		*567[*]	abc <b>567</b> * 1234 <b>567</b> *	345678
[?]	Write place holder in square brackets to use them as character in the mask.	123[?]?	<b>123</b> ?4 <b>123</b> ?a <b>123</b> ??	12345 123ab
[]		12[]a*	<b>12</b> [a45 <b>12</b> [abc	12a45
[]		12[]a*	<b>12</b> [a45 <b>12</b> [abc	12a45

## G. Error codes in Decapper 550 Software

Error Codes	
103	More than one barcode found: There more than one label on the same side of the rack or a misreading happened by choosing an inappropriate code type. Check if the correct code type has been chosen and avoid using different types in the same setting
104	Bar code not decoded: A code structure was detected, but it was not possible to get any information out of it. The code may be damaged or partly covered.
105	Wrong bar code mask. The code was present and readable, but does not fit to the specified bar code mask.

Error Codes	
106	No bar code detected: It was not possible to detect anything that looks similar to a code. The position is either empty or occupied with a tube that has no code.
107	Bar code has no readable characters: Reading of special characters like commas or semicolons might indicate the choice of the wrong code type.
823	Bar code (rack code) was not detected as requested.
830	Invalid profile: Profile must contain one rack type only.

## H. Control and Indicators for Decapper 550 Software



### NOTE

The "Start button" of the Decapper 550 is not used for the code reading.

### Start button

OFF

Device not ready for reading

- Software not initialised
- Power not connected

ON

Device ready for reading

- Software is initialised
- Reading can be started by pressing the button

BLINKING

Device is busy

- Picture transmission in process
- Decoding in process



## Status LED

OFF

Device is not ready for reading

- USB not connected
- Computer is switched off

GREEN

Device is ready for reading

- Software is initialised and ready for reading
- Software shows no error

RED

Device is not ready for reading

- Software shows an error
- Software not initialised



## Log

The log window shows a listing of the processes needed for decoding.

A screenshot of a software log window. The window has a dark background and a menu bar at the top with options: File, View, Camera, Main, Profiles, Profiles Editor, and Log. The Log menu item is highlighted. Below the menu bar is a table with columns for Time, Level, and Message. The table contains several log entries, including information about initialization, controller instantiation, and profile loading, ending with an error message: "Camera not found (Error 12)".

Time	Level	Message
31.10.2014 15:57:57	Info	Start initialization...
31.10.2014 15:57:57	Info	Instantiate EasyCodeII...
31.10.2014 15:57:58	Info	Instantiate EasyCodeII done.
31.10.2014 15:57:58	Info	Instantiate Controller...
31.10.2014 15:57:58	Info	Discovery service is running
31.10.2014 15:57:58	Info	Simple XML RPC is running.
31.10.2014 15:57:58	Info	Instantiate Controller done.
31.10.2014 15:57:58	Info	Load Profiles.
31.10.2014 15:57:58	Info	Load Profiles done.
31.10.2014 15:57:58	Info	Initialization done.
31.10.2014 15:57:59	Error	Camera not found (Error 12).

Thermo Fisher Scientific, Inc.  
75 Panorama Creek Drive  
Rochester, NY 14625 USA

Technical Support:  
North America  
Tel: +585 586 8800  
1 800 625 4327  
Email: [technicalsupport@thermofisher.com](mailto:technicalsupport@thermofisher.com)

Europe  
+49 (0) 6184 906 000  
Email: [orders.labequipment.de@thermofisher.com](mailto:orders.labequipment.de@thermofisher.com)

Find out more at [thermofisher.com/samplestorage](https://thermofisher.com/samplestorage)

**ThermoFisher**  
S C I E N T I F I C