

E-Gel™ Power Snap Electrophoresis System

USER GUIDE

E-Gel™ Power Snap Electrophoresis Device and E-Gel™ Power Snap Camera

For use with E-Gel™, E-Gel™ EX, E-Gel™ Go!, CloneWell™, and SizeSelect™ agarose gels

Catalog Numbers G8100, G8200, G8300, G8141ST, G8142ST, G8151ST, G8152ST, G8168ST, G8162ST, G8341ST, G8342ST, G8351ST, G8352ST and A33811

Publication Number MAN0017050

Revision B.0





Thermo Fisher Scientific Baltics UAB | V.A. Graiciuno 8, LT-02241 | Vilnius, Lithuania

For descriptions of symbols on product labels or product documents, go to thermofisher.com/symbols-definition.

The information in this guide is subject to change without notice.

DISCLAIMER: TO THE EXTENT ALLOWED BY LAW, LIFE TECHNOLOGIES AND/OR ITS AFFILIATE(S) WILL NOT BE LIABLE FOR SPECIAL, INCIDENTAL, INDIRECT, PUNITIVE, MULTIPLE, OR CONSEQUENTIAL DAMAGES IN CONNECTION WITH OR ARISING FROM THIS DOCUMENT, INCLUDING YOUR USE OF IT.

Revision history: Revision history of Pub. No. MAN0017050

Revision	Date	Description
B.0	08 April 2020	Corrections throughout manual.
A.0	7 September 2017	First version

Important Licensing Information: This product may be covered by one or more Limited Use Label Licenses. By use of this product, you accept the terms and conditions of all applicable Limited Use Label Licenses.

Corporate entity: Life Technologies Corporation | Carlsbad, CA 92008 USA | Toll Free in USA 1 800 955 6288

Trademarks: All trademarks are the property of Thermo Fisher Scientific and its subsidiaries unless otherwise specified.

©2020 Thermo Fisher Scientific Inc. All rights reserved.

Contents

About this guide	7
Purpose of the guide.....	7
Safety	7
Product Information	8
Product description	8
Features	8
Throughput	8
System components.....	8
Kit contents and storage.....	9
Upon receiving the instrument.....	9
Storage.....	9
Description of parts.....	10
Front view.....	10
Parts of the E-Gel™ Power Snap Electrophoresis Device	11
Parts of the E-Gel™ Power Snap Camera.....	12
User graphical interface overview.....	13
Using the E-Gel™ Power Snap Electrophoresis Device	14
Required materials.....	14
Prepare samples.....	14
Dilute samples containing high salt.....	15
DNA ladder preparation guidelines.....	15
Prepare gel.....	16
Prepare E-Gel™ Go! Agarose Gel	16
Sample loading guidelines.....	17
Load samples.....	17
Run the gel.....	18
Check status	19
View gel.....	19
View gel with filter lid open	19
Modify a run	19
Pause the run	19
Cancel the run	20
Edit gel duration.....	20
Change to another protocol.....	20
Using the E-Gel™ Power Snap Camera.....	21
General guidelines	21
Set up the camera	21
Modify camera settings.....	21

Home screen.....	21
Attach the camera.....	22
Remove the camera.....	22
View gel.....	23
Capture image.....	23
Adjust capture settings.....	23
Automatic image capture.....	24
Cancel auto capture.....	24
Export image.....	24
Export from capture screen.....	24
Export from image gallery.....	24
E-Gel™ CloneWell™ II gels.....	25
Advantages.....	25
General guidelines.....	25
Prepare samples.....	25
Prepare gel.....	25
Load samples.....	26
Run the gel.....	26
Check status.....	26
Prepare wells.....	26
Collect DNA fragment.....	27
Guidelines for estimating run time.....	27
Troubleshooting.....	28
E-Gel™ SizeSelect™ II gels.....	29
Advantages.....	29
General guidelines.....	29
Prepare samples.....	29
Prepare gel.....	29
Load samples.....	30
Run the gel.....	30
Check status.....	30
Prepare wells.....	30
Collect DNA fragment.....	31
Guidelines for estimating run time.....	31
Quantitation of isolated DNA.....	33
Troubleshooting.....	34
Appendix A.....	35
Troubleshooting.....	35
Appendix B.....	37
System maintenance.....	37
Materials required.....	37
Cleaning.....	37

Upgrade system firmware	37
Battery replacement.....	38
Instrument Specifications.....	38
Instrument dimensions and specifications.....	38
Electrical requirements.....	39
Environmental requirements.....	39
Appendix C.....	40
E-Gel™ agarose gels	40
Choosing the right gel.....	41
Analytical gels	41
Gels for preparative gel electrophoresis in Cloning and NGS applications	41
Other available gel types for routine electrophoresis.....	42
Opening E-Gel™ cassettes.....	42
Gel Knife.....	42
Open E-Gel™ EX and NGS cassettes with a Gel Knife.....	42
Cleaning and storage.....	43
E-Gel™ Opener	43
Open the E-Gel™ cassette with an E-Gel™ Opener.....	44
Cleaning and storage.....	44
E-Gel™ agarose gel disposal guidelines.....	44
Appendix D	45
Choosing the right DNA ladder.....	45
Appendix E.....	46
Running RNA Samples on E-Gel™ EX Agarose Gels.....	46
Non-denaturing conditions	46
Denaturing agents.....	46
Denaturing conditions.....	46
Appendix F.....	47
E-Gel™ Power Snap Blue-Light Transilluminator.....	47
Imaging E-Gels on Third Party Gel Imagers.....	47
Nucleic acid stain use in E-Gel™ agarose gels.....	48
SYBR™ Safe DNA Gel Stain	48
Safety features.....	48
Cloning benefits	48
Disposal.....	48
Spectrum.....	48
Visualization.....	48
SYBR™ Gold II Gel Stain.....	49
Disposal.....	49
Spectrum.....	49
Visualization.....	49
Appendix G	50

Instrument starter kits.....	50
E-Gel™ agarose gels	52
Accessory products	52
Accessory items.....	53
Appendix H	54
Safety.....	54
Before starting.....	54
Installing the instrument	55
Electromagnetic compatibility (EMC) standards	55
Class A notice	55
Electrical safety.....	56
Service operation requirements.....	56
LED (Light-Emitting Diode)	56
Explanation of symbols and warnings.....	57
Appendix I.....	58
Customer and technical support.....	58
Limited product warranty	58

About this guide

Important: Before using this product, read and understand the information in the “Safety” appendix in this document.

Purpose of the guide

This user guide contains detailed information about usage of the E-Gel™ Power Snap Electrophoresis System and E-Gel™ pre-cast agarose gels. The guide is intended to supplement the Quick Reference Cards for E-Gel™ products. Details for sample preparation and electrophoresis conditions are included in this guide.

To request Quick Reference Cards (QRCs) or for additional information, contact Technical Support, or download the appropriate QRC from thermofisher.com.

Safety

Some commercially available E-Gel™ agarose gels contain ethidium bromide, a known mutagen. The concentration of ethidium bromide in each gel ranges from 0.1 to 0.3 µg/mL. All E-Gel™ agarose gels contain 0.055% Proclin added as a preservative. Each gel is provided in a sealed package to protect users from exposure. As a precaution, always wear gloves and protective clothing when handling the gels.

- Dispose of used E-Gel™ agarose gels containing ethidium bromide, E-Gel™ EX, and E-Gel™ SizeSelect™ Agarose Gels as hazardous waste.
- Avoid overexposure of skin and eyes when using UV light with third party devices.
- Avoid overexposure of eyes when using intense blue light.
- Avoid touching the gel during electrophoresis.

Product Information

Product description

The E-Gel™ Power Snap Electrophoresis System is designed to produce a fast and convenient DNA agarose gel electrophoresis and documentation workflow.

The E-Gel™ Power Snap Electrophoresis System is composed of two units:

The **E-Gel™ Power Snap Electrophoresis Device** consists of a power supply, blue light transilluminator, and amber filter to enable gel separation and real-time sample tracking of samples in E-Gel™ agarose gels pre-stained with SYBR™ Safe or SYBR™ Gold II DNA stains. The device is pre-programmed with protocols for each type of available E-Gel™ agarose gel.

The **E-Gel™ Power Snap Electrophoresis Camera** is a seamlessly integrated part of the E-Gel™ Power Snap Electrophoresis System. The cable-free, high-resolution digital camera is designed for rapid imaging and documentation of E-Gel™ agarose gels. Camera functions include real-time view, automatic capture, and image adjustment features.

The system is optimized for use with E-Gel™ EX, E-Gel™ SYBR Safe, E-Gel™ Go!, E-Gel™ CloneWell™ II, and E-Gel™ SizeSelect™ II gels, as well as the E-Gel™ EX Double Comb and E-Gel™ Double Comb with SYBR Safe.

Features

- **Fast DNA separation** in as little as 5 minutes for with E-Gel™ EX Agarose Gels
- **Real-time sample view** for instant analysis and run control
- **Quick gel image documentation** with E-Gel™ Power Snap Camera
- **Dry pre-cast gels** – no need for gel preparation

Throughput

The E-Gel™ Power Snap Electrophoresis System is used with medium throughput E-Gel™ Double Comb (1-22 DNA samples per gel), routine throughput E-Gel™ agarose gels (1-11 DNA samples per gel), or very low throughput E-Gel™ Go! agarose gels (1-4 DNA samples per gel).

The 48- and 96-well format high-throughput E-Gel™ agarose gels are used with the E-Gel™ e-Base™ Electrophoresis System, which must be acquired separately. To learn more about high-throughput E-Gel™ agarose gel electrophoresis visit www.thermofisher.com/egel.

System

components

The E-Gel™ Power Snap Electrophoresis System consists of:

- E-Gel™ Power Snap Electrophoresis Device
- E-Gel™ Power Snap Electrophoresis Camera (requires E-Gel™ Power Snap Electrophoresis Device)

Kit contents and storage

Depending on the ordered catalog number the product will arrive with following components:

Component	G8100	G8200	G8300
E-Gel™ Power Snap Electrophoresis Device	1 each	—	1 each
E-Gel™ Power Snap Camera ^[1]	—	1 each	1 each
E-Gel™ Go! Adapter for E-Gel™ Power Snap Electrophoresis Device	1 each	—	1 each
Power cord with adaptor	1 each	—	1 each
Safe Imager™ Viewing Glasses (Cat. No. S37103)	1 each	—	1 each

^[1] Requires E-Gel™ Power Snap Electrophoresis Device

Upon receiving the instrument

The E-Gel™ Power Snap Electrophoresis Device and E-Gel™ Power Snap Camera are shipped at room temperature.

Examine the unit carefully for any damage incurred during transit. File any damage claims with the carrier. The warranty does not cover in-transit damage.

Storage

E-Gel™ Power Snap Electrophoresis Device

- Store the devices at room temperature.
- Do not store or use the electrophoresis bases at 4°C.

E-Gel™ agarose gels

- Store E-Gel™ pre-cast gels ONLY at room temperature.
- Do not allow the temperature to drop below 4°C or rise above 40°C.
- Gels are guaranteed to be stable for at least 2 to 6 months upon receipt. Refer to the expiration date printed on the packaging of your E-Gel™ agarose gel.
 - E-Gel™ with SYBR™ Safe are stable for at least 4-6 months
 - E-Gel™ EX Double Comb are stable for 3-4 months
 - E-Gel™ Double Comb with SYBR™ Safe are stable for 4-5 months
 - E-Gel™ CloneWell™ II Agarose Gels with SYBR™ Safe are stable for 4-5 months
 - E-Gel™ SizeSelect™ II are stable for 5-6 months
 - E-Gel™ NGS are stable for 5-6 months

Description of parts

Front view

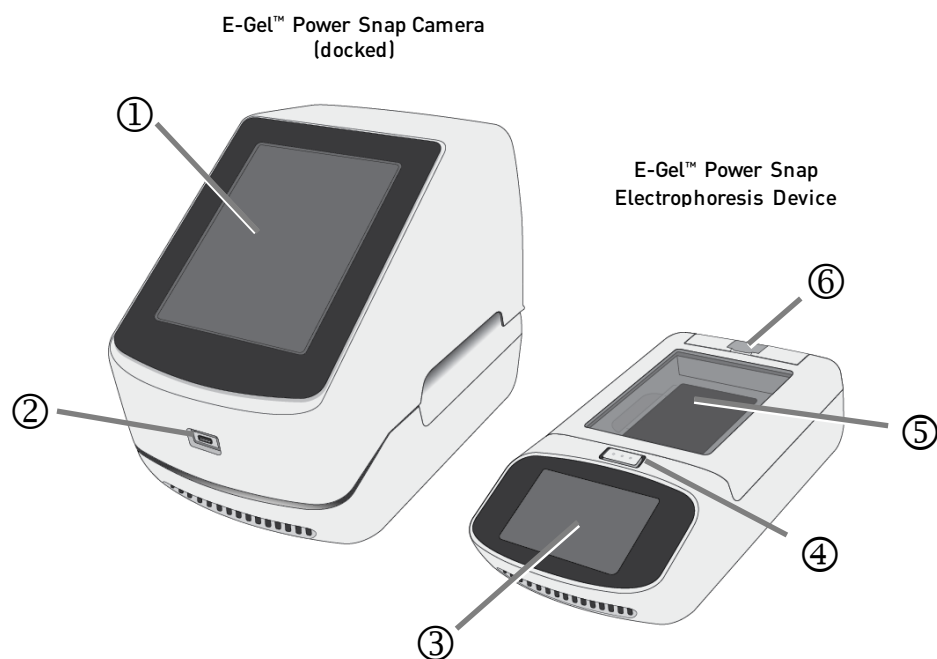

- ① Camera control touch screen
- ② USB port for image export/firmware upgrade
- ③ Electrophoresis unit control touch screen
- ④ Open button for filter lid
- ⑤ Lid with amber filter
- ⑥ Docking connector cover

Parts of the E-Gel™ Power Snap Electrophoresis Device

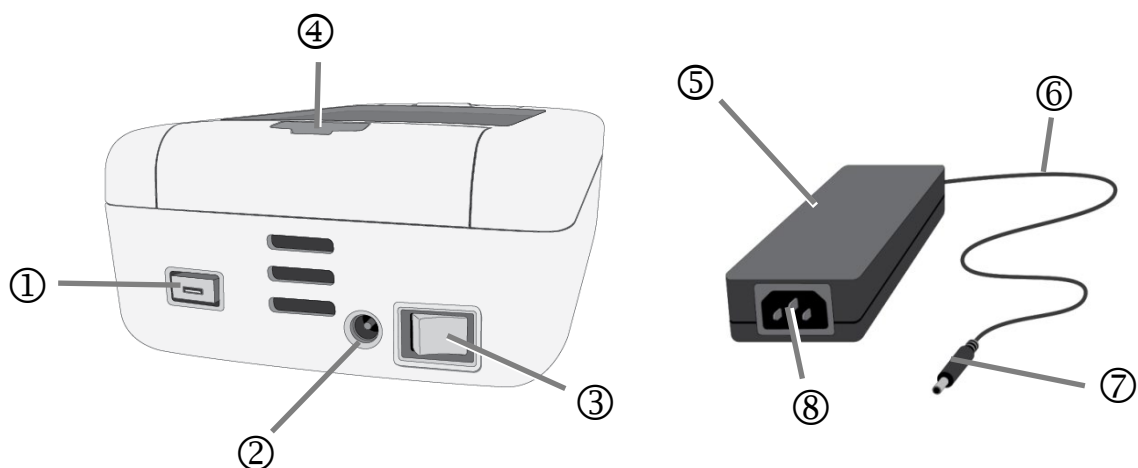

- ① USB port for firmware upgrade
- ② DC input
- ③ Power switch
- ④ Docking connector cover

- ⑤ Adaptor
- ⑥ DC output cable
- ⑦ Connector to DC input of electrophoresis unit
- ⑧ AC power cord inlet

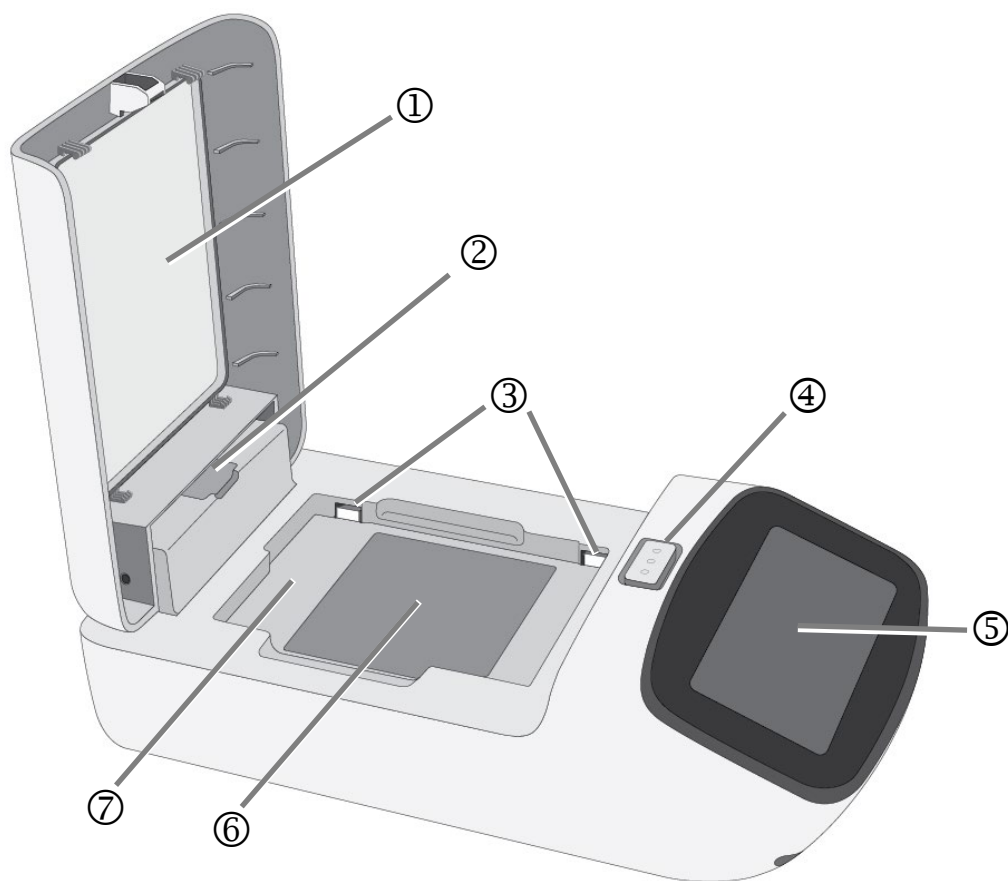

- ① Lid with amber filter (open)
- ② Docking connector cover
- ③ Electrodes
- ④ Open button for filter lid

- ⑤ Electrophoresis unit control touch screen
- ⑥ Blue-light transilluminator
- ⑦ E-Gel™ cassette compartment



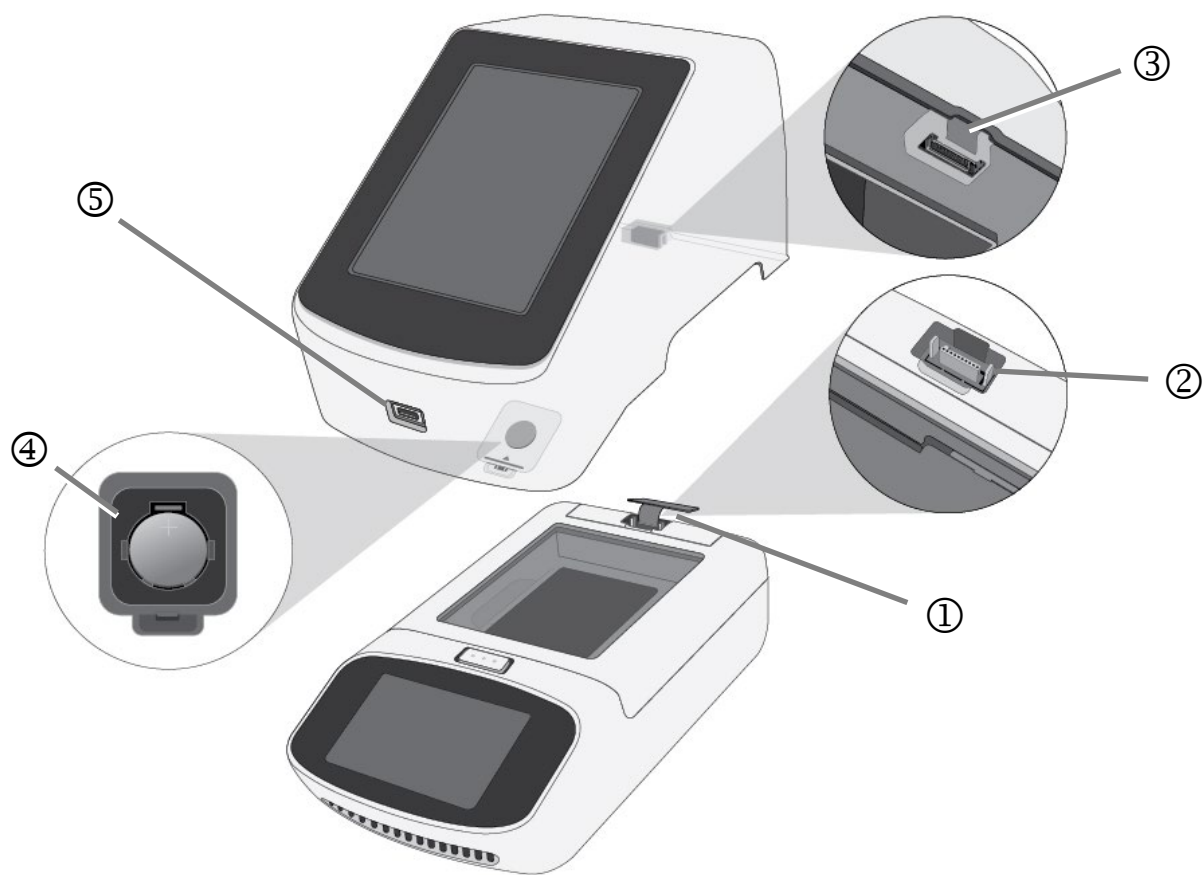







Parts of the E-Gel™ Power Snap Camera

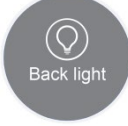

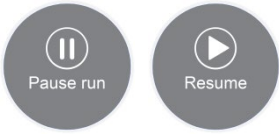
- ① Docking connector cover (open)
- ② Docking connector
- ③ Camera connector
- ④ Battery compartment
- ⑤ USB port for image export/firmware upgrade

User graphical interface overview

The E-Gel™ Power Snap Electrophoresis System is intuitive and easy-to-use. Both the E-Gel™ Power Snap Electrophoresis Device and E-Gel™ Power Snap Camera are controlled using touch screens. The following table describes common controls of the Power Snap system.

Control	Function
E-Gel™ Power Snap Electrophoresis Device controls	
	Initiate gel run workflow
	Status dial
	Switch on/off blue light transilluminator
	Settings screen to access: <ul style="list-style-type: none"> • About instrument • Screen brightness • Software update • Service mode
	Pause/Resume gel run
	Run last protocol/select gel protocol
E-Gel™ Power Snap Camera controls	
	Status dial to view gel and access: <ul style="list-style-type: none"> • Capture gel image • Edit/adjust capture settings • Export image
	Gallery screen to access: <ul style="list-style-type: none"> • Actions screen to Edit, Delete, or Export images • Sort images
	Capture gel image
	Return to Home screen (countdown timer/view gel)
	Settings screen to access: <ul style="list-style-type: none"> • Instrument settings • About instrument • Auto capture • Software update • Service mode

Using the E-Gel™ Power Snap Electrophoresis Device

This section provides instructions for performing electrophoresis using the E-Gel™ Power Snap Electrophoresis Device.

For specific protocols describing the use of E-Gel™ CloneWell™ II Agarose Gels, see page 25.

For specific protocols describing the use of E-Gel™ SizeSelect™ II Agarose Gels, see page 29.

Required materials

For electrophoresis:

- E-Gel™ Power Snap Electrophoresis Device
- Safe Imager™ Viewing Glasses (included)
- DNA sample
- E-Gel™ agarose gel cassette (see **Choosing the right gel**, page 41).
- E-Gel™ DNA Ladder (see **Choosing the DNA ladder**, page 45) or other appropriate molecular weight ladder
- Optional: 1X E-Gel™ Sample Loading Buffer (Cat No. 10482055)
- Optional: E-Gel™ Go! Adapter for E-Gel™ Power Snap Electrophoresis Device

For E-Gel™ gel documentation:

- E-Gel™ Power Snap Camera (Cat. No G8300), E-Gel™ Imager, or other third-party imager.
- USB storage device (not included)

Prepare samples

Sample preparation is critical for separation quality. Follow these guidelines for best result.

- Prepare DNA sample in deionized water or 1X E-Gel™ Sample Loading Buffer.
- **Use the indicated amount of DNA per well** for single or multiple bands. If you are unsure how much to use, test a range of concentrations to determine the optimal concentration for your particular sample. Overloading DNA will cause poor resolution.

Gel Type	% Agarose	Amount of DNA per Well		Total Loading Volume
		Sample with Single Band	Sample with Multiple Bands	
E-Gel™ EX	1%	0.5–100 ng	50 ng	20 µL
	2%, 4%	0.5–100 ng	50 ng	
E-Gel™ EX Double Comb	1%	0.5–100 ng	50 ng	
	2%	0.5–100 ng	50 ng	
E-Gel™ with SYBR™ Safe	1%	5–300 ng	500 ng	
	2%, 4%	5–300 ng	500 ng	
E-Gel™ Double Comb with SYBR™ Safe	1%	5–300 ng	500 ng	
	2%	5–500 ng	500 ng	
E-Gel™ Go!	1%	0.5–100 ng	200 ng	10 µL
E-Gel™ CloneWell™ II	0.8%	200–800 ng	800 ng	25 µL
E-Gel™ SizeSelect II	2%	1–300 ng	500 ng	
E-Gel™ NGS	0.8%	20–100 ng	500 ng	

Dilute samples containing high salt

E-Gel™ EX gels are sensitive to high salt and EDTA content. Samples containing ≥50 mM NaCl, 100 mM KCl, 10 mM acetate ions, or 10 mM EDTA (i.e., certain restriction enzyme and PCR buffers) cause loss of resolution on E-Gel™ agarose gels.

Dilute samples as suggested below:

- Dilute E-Gel™ EX agarose gels 10-30 fold.
- Dilute E-Gel™ SYBR™ Safe agarose gels 2-10 fold.
- Dilute E-Gel™ EX Double Comb agarose gels 10-30 fold.

DNA ladder preparation guidelines

- Dilute the ladder accordingly with deionized water or 1X E-Gel™ Sample Loading Buffer.
- **Use the indicated amount of ladder per well.** Overloading the ladder will result in distorted or incomplete band separation.

E-Gel™ DNA Ladder	E-Gel™ EX	E-Gel™ EX Double Comb	E-Gel™ with SYBR™ Safe	E-Gel™ EX Double Comb with SYBR™ Safe	E-Gel™ CloneWell II	E-Gel™ SizeSelect II	E-Gel™ Go!	E-Gel™ NGS
E-Gel™ Ultra Low Range DNA Ladder	4 µL (100 ng)	—	20 µL (500 ng)	—	—	—	—	—
E-Gel™ 50 bp DNA Ladder	2 µL (50 ng)	2 µL (50 ng)	20 µL (500 ng)	20 µL (500 ng)	—	2 µL (50 ng)	10 µL (250 ng)	—
E-Gel™ 1 Kb Plus DNA Ladder	2 µL (50 ng)	2 µL (50 ng)	20 µL (500 ng)	20 µL (500 ng)	25 µL (625 ng)	—	10 µL (250 ng)	—
E-Gel™ 1 Kb Plus Express	2 µL (80 ng)	—	20 µL (800 ng)	20 µL (800 ng)	25 µL (1,000 ng)	—	5 µL (200 ng)	—
E-Gel™ Sizing DNA Ladder	—	—	—	—	—	25 µL (50 ng)	10 µL (20 ng)	25 µL (50 ng)
E-Gel™ Low Range Quantitative DNA Ladder	5 µL (87.5 ng)	3 µL (52.5 ng)	20 µL (350 ng)	20 µL (350 ng)	—	—	10 µL (175 ng)	—
E-Gel™ 96 High Range	3 µL (15 ng)	3 µL (15 ng)	20 µL (100 ng)	20 µL (100 ng)	—	—	—	—

Prepare gel

1. Remove E-Gel™ agarose gel from package.
2. Gently remove comb from the cassette.
3. Load the gel into the cassette compartment, starting from the right edge.
4. Press down on the left side of the cassette to secure the cassette.
5. Load gels within 15 minutes after opening the package.

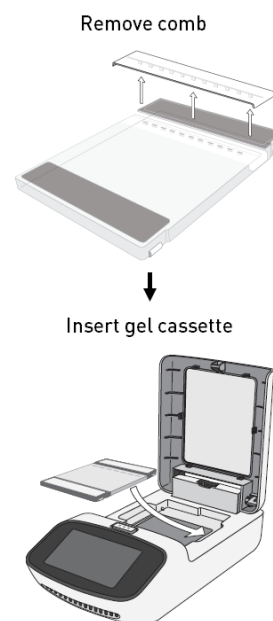

Prepare E-Gel™ Go! Agarose Gel

1. Remove E-Gel™ Go! Agarose Gel from package.
2. Gently remove comb from the cassette.
3. Place the cassette into the E-Gel™ Go! Adaptor.
4. Load the adaptor containing the gel into the cassette compartment, starting from the right edge.
5. Press down on the left side of the cassette to secure the cassette.
6. Load gels within 15 minutes after opening the package.

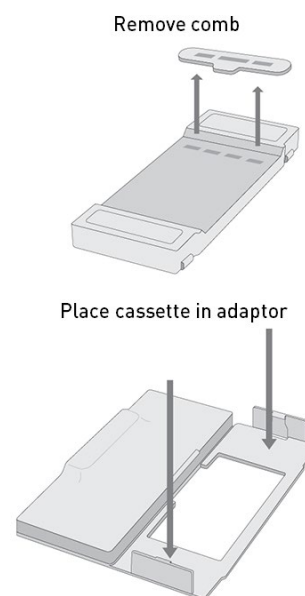

Sample loading guidelines

- Use the recommended total loading volume for each gel type. Do not load more than recommended amount of DNA sample or ladder per well.
- Load deionized water into all empty wells.
- Keep all sample volumes uniform. If you do not have enough samples to load all the wells of the gel, load an identical volume of deionized water into any empty wells. Prepare your samples by adding E-Gel™ 1X Sample Loading Buffer or deionized water to the required amount of DNA to bring the total required sample volume.
- Avoid introducing bubbles while loading. Bubbles can cause band distortion.

Gel type	Total loading volume
E-Gel™ EX	20 µL
E-Gel™ with SYBR™ Safe	
E-Gel™ EX Double Comb	
E-Gel™ Double Comb with SYBR™ Safe	
E-Gel™ Go!	10 µL
E-Gel™ CloneWell II	25 µL
E-Gel™ SizeSelect II	25 µL
E-Gel™ NGS	20 µL

Load samples

1. Load prepared samples. Keep all sample volumes uniform.
2. Load prepared DNA ladder.
3. Load 1X E-Gel Sample Loading Buffer or deionized water in all empty wells.
4. Run gels within 1 minute after loading samples.



Run the gel

1. **Press Set up run** to start E-Gel™ protocol selection.
2. **Select** the E-Gel™ protocol corresponding to your gel type.
Use the up/down arrows to navigate through the menu.
3. (*Optional*) For recurring experiments, select the last used protocol.

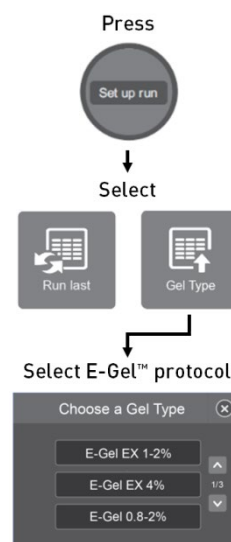

Gel Type	Recommended program	Default run time	Maximum run time
E-Gel™ EX Agarose Gel, 1% and 2%	E-Gel EX 1-2%	10 min	20 min
E-Gel™ EX Agarose Gel, 4%	E-Gel EX 4%	15 min	20 min
E-Gel™ EX Double Comb Agarose Gels, 1% and 2%	E-Gel EX 1-2%	5 min	8 min
E-Gel™ Agarose Gel with SYBR™ Safe, 1%, 2%	E-Gel 0.8-2%	26 min	40 min
E-Gel™ Agarose Gel with SYBR™ Safe, 4%	E-Gel 4%	30 min	40 min
E-Gel™ Double Comb SYBR™ Safe Agarose Gels, 1% and 2%	E-Gel Double Comb	13 min	18 min
E-Gel™ CloneWell™ II Agarose Gel, 0.8%	CloneWell 0.8%	12 min	40 min
E-Gel™ SizeSelect™ II Agarose Gel, 2%	SizeSelect 2%	8 min	20 min
E-Gel™ NGS™ Agarose Gel, 0.8%	E-Gel 0.8-2%	26 min	32 min
E-Gel™ Go! Agarose Gel, 1% and 2%	E-Gel Go! 1-2%	15 min	30 min
Reverse protocol for: E-Gel™ CloneWell™ II Agarose Gel E-Gel™ SizeSelect™ II Agarose Gel	Reverse E-Gel	2 min	3 min

4. (Optional) **Adjust the duration** of the gel run using the +/- buttons or press in the duration field to open a keyboard to enter a number.
5. Press **Start run** to begin running the gel.
Note: Do not exceed the maximum run time indicated for the specific gel type, as this will impact separation quality.
6. The run stops automatically after the programmed time has elapsed and beeps.
 - a. **Press More time** to run the gel longer.
 - b. **Press Done** to end the protocol.
7. Proceed to image capture (see page 21) or other downstream application.



Check status

The status and the remaining run time of the protocol are indicated on the status dial.

DNA separation can be viewed in real time by turning on the transilluminator. This feature is only compatible with gels containing dyes visible by blue light transillumination (i.e., E-Gel™ EX, E-Gel™ SYBR™ Safe, E-Gel™ Double Comb (with EX and SYBR™ Safe dyes), E-Gel™ CloneWell™ II, E-Gel™ SizeSelect™ II and E-Gel™ Go! agarose gels).

For optimal viewing, dim the ambient lighting in the room, or use the E-Gel™ Power Snap Camera for visualization (see page 23).

View gel

1. Press **Back light** to activate the blue light transilluminator.
Note: The transilluminator turns off automatically after 1 minute.
2. **Monitor** the sample in real-time during the run.
3. Press **Back light** again to switch off the blue light transilluminator.

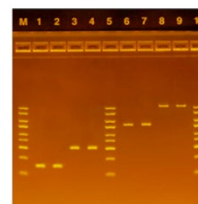
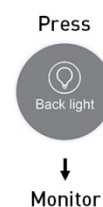

View gel with filter lid open

Important! Always wear Safe Imager™ Viewing Glasses when viewing the gel with the filter lid opened.

The transilluminator turns off automatically when the filter lid is opened.

Press **Back light** to re-activate the blue light transilluminator.

Modify a run

The E-Gel™ protocol can be cancelled or modified during the run. However, the device does not allow the duration to exceed the maximum allowable run time for the specific E-Gel™ protocol.

Pause the run

1. Press **Pause run** to temporarily stop the run.
2. Press **Resume** to restart the run.



Cancel the run

1. Press **Pause run** to temporarily stop the run.
2. Press the status dial.
3. Press **Cancel run** to stop the run.

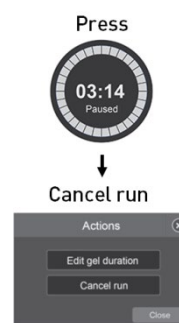

Edit gel duration

1. Press **Pause run** to temporarily stop the run.
2. Press the status dial.
3. Press **Edit gel duration**.
4. Adjust the **protocol duration** using the +/- buttons or press in the duration field to open a keyboard to enter a number.
5. Select **Resume** to restart the run.

Note: Do not run the same gel multiple times or extend the gel protocol beyond the maximum allowed duration. Running the gel past the allowed duration will damage the gel and result in poor sample separation.



Change to another protocol

1. Press **Pause run** to temporarily stop the run.
2. Press the status dial.
3. Press **Cancel run** to stop the run.
4. Press **Set up run**.
5. Select another E-Gel™ protocol (e.g., **Reverse E-Gel**). Use the up/down arrows to navigate through the menu.
6. Press **Start run**

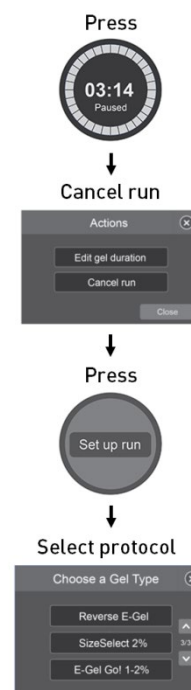

Using the E-Gel™ Power Snap Camera

General guidelines

- The E-Gel™ Power Snap Camera is an integral part of The E-Gel™ Power Snap Electrophoresis System, and only works when docked to The E-Gel™ Power Snap Electrophoresis Device.
- The E-Gel™ Power Snap Camera, is designed for imaging pre-cast E-Gel™ agarose gels. It is not suitable for use with any third party products or pour-your-own agarose gels.
- The E-Gel™ Power Snap Camera does not require connection to a desktop computer. Data is transferred from the camera using an USB storage device.

Set up the camera

The first time the camera is started requires the date and time to be set.

1. Select **Settings** / .
2. Select **Instrument settings**.
3. Select **Date/Time**.
4. Choose the date and time format, then select **Done**.
5. Set the current date and time, then select **Done**.



Modify camera settings

Access E-Gel™ Power Snap Camera settings from the home screen by pressing **Settings** / .

- Select **Instrument setting** to adjust screen brightness, default image size/type, and sleep mode features.
- Select **Update software** to install the latest firmware update.

Home screen

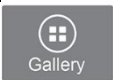
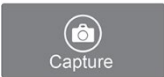
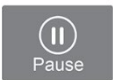
The home screen displays the status dial, which shows a countdown timer when the gel is running. Three additional buttons are displayed across the bottom of the screen.

Control	Function
	View gel image and access: <ul style="list-style-type: none">• Capture gel image• Edit/adjust capture settings• Export image
	Access image gallery
	Capture gel image
 	Pause/resume gel run

Attach the camera

The E-Gel™ Power Snap Camera can be attached to the E-Gel™ Power Snap Electrophoresis Device either during a run, or after the run is completed.

1. **Unfasten** the docking connector cover.
2. **Align** the docking connector with the camera connector.
3. **Lower** the E-Gel™ Power Snap Camera on top of the electrophoresis device and gently snap the camera in place.
4. Once **connected**, the E-Gel™ Power Snap Camera displays a brief welcome splash screen, which changes to the home screen when it is ready to use.



Remove the camera

1. Carefully hold the sides of the camera hood and insert your fingers toward the rear of the handhold.
 2. **Lift the camera straight upwards.**
- IMPORTANT! Do not tilt** the camera backwards during removal to avoid damaging the docking connectors.



View gel

1. Press **View Gel** to access the view gel screen and visualize the bands on the gel.
2. **Adjust exposure setting** if necessary.

Note: The gel image in the capture screen is a still picture which is refreshed periodically, or when adjustment sliders are used. When viewing an ongoing gel run, you will not see smooth band migration in real time.

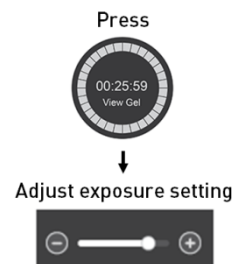

Capture image

Images can be captured from the view gel, capture, and home screens.

1. Press **Capture** to access the capture screen and save image(s) to the camera.
2. Adjust capture settings if necessary.

Adjust capture settings

Settings for the E-Gel™ Power Snap Camera other than exposure can be adjusted during the capture session.

1. Press **Edit** from the capture screen.
2. Select the desired image setting from the drop down menu.
3. Use +/- or move the slider to adjust the selected setting.
4. Press **Done** to confirm the change.
5. Press **Capture** to capture the image with the new settings.

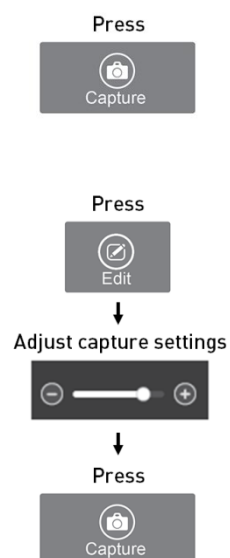

Setting	Detail
Brightness	Adjusts image brightness settings.
Contrast	Adjusts image contrast settings.
Invert	Converts image into grayscale and inverts color palette.
Grayscale	Converts image into a grayscale.

Automatic image capture

The E-Gel™ Power Snap Camera can automatically capture images as the gel runs. The camera can capture and save 2–5 images of the gel at evenly spaced intervals.

1. Press **Settings** / .
2. Select **Auto capture**.
3. Select one of following capture methods:
 - a. Smart exposure: captures each image at the optimal exposure level.
 - b. Multiple exposures: captures each image at three different exposure levels.
4. Select the number of images to be captured.
5. Select the time at which image capture will start (5, 10, 15, or 20 minutes prior to the end of the protocol).
6. Press **Start** to begin the automatic capture session.

Cancel auto capture

1. Press **Home**.
2. Select **Yes**.

Press



Export image

Images can be exported from the capture screen or the image gallery. The number of images captured in an active capture session will appear on the Export button on the capture screen. Images previously stored on internal memory are accessed from the image gallery.

Export from capture screen

1. Insert a USB storage device into the USB port at the front of the E-Gel™ Power Snap Camera.
2. Press **Export** from the capture screen.
3. Review the images in the active session gallery, and select files for export.
4. (Optional) Select **Edit info** to change the file name, file type (Jpeg, TIFF, or VIT format), or add comments.
5. Press **Export** to export active session images to the USB storage device.

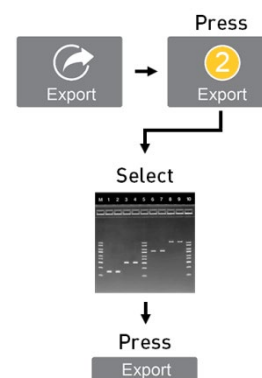

Export from image gallery

1. Insert a USB storage device into the USB port at the front of the E-Gel™ Power Snap Camera.
2. Press **Gallery** from the home screen.
3. Select **Thumbnails** or **List view** for navigation.
4. (Optional) Select **Sort** to organize files by date, or file type.
5. Press an image(s) to select the file, or press again to de-select the file.
6. Select **Actions** from the gallery screen.
7. (Optional) Select **Delete** to delete selected image(s) from the camera.
8. (Optional) Select **Edit info** to change the file name, or add comments.
9. Select **Export** to export selected image(s) to the USB storage device.



E-Gel™ CloneWell™ II gels

E-Gel™ CloneWell™ II pre-cast agarose gels are designed for use with the E-Gel™ Power Snap Electrophoresis Device, and provide a fast, safe, and effective DNA fragment isolation method for DNA cloning workflows.

- Advantages**
- Target fragments are collected directly from a recovery well. No gel-purification is required.
 - Contains SYBR™ Safe DNA stain, eliminating the risk of DNA damage, and improving cloning efficiency by avoiding UV transillumination.
- General guidelines**
- Load gel within 15 minutes of opening the pouch; run the gel immediately after loading.
 - Monitor the band of interest carefully as it migrates near the recovery wells. It may be difficult to see low amounts of DNA in the well.
 - **Important!** Always wear Safe Imager™ Viewing Glasses when viewing the gel with the filter lid opened.
 - For guidance on disposal of used gels, see SYBR™ Safe DNA Gel Stain (page 48).

Prepare samples

- Prepare up to 25 µL of sample in 1X Sample Loading Buffer (e.g., use 2.5 µL of 10X Sample Loading Buffer with 22.5 µL total sample). 10X Sample Loading Buffer is provided with E-Gel™ Clonewell™ II Agarose Gels.
- **Use the indicated amount of DNA per well** for single or multiple bands.
- Divide samples with higher amounts of DNA across multiple wells.
- Use up to 25 µL total sample volume per well.
- Dilute high salt samples (certain restriction enzyme and PCR buffers) 2- to 5-fold.

Gel type	Amount of DNA per well		Total loading volume
	Sample with single band	Sample with multiple bands	
E-Gel™ CloneWell II	200-800 ng	800 ng	25 µL

Prepare gel

1. **Remove** the gel from the package.
2. Gently **remove** the combs. Do not allow the combs to bend or create suction in the wells during removal.
3. **Insert** gel cassette into the E-Gel™ Power Snap Electrophoresis Device, starting from the right edge.
4. Press down on the left side of the cassette to secure it into the device.



Load samples

1. Fill all wells of both rows with 50 μL of deionized water.
2. Load 25 μL of sample with 1X Sample Loading Buffer into wells from the bottom up. Do not damage the gel or introduce bubbles into the wells.
3. Load 25 μL of ready-to-use E-Gel™ 1 Kb Plus Express DNA Ladder into a well.

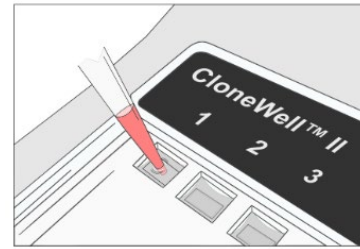

Run the gel

1. Press **Set up run**, then select the **CloneWell 0.8%** protocol on E-Gel™ Power Snap Electrophoresis Device.
2. Determine the estimated run time. See the E-Gel™ 1 Kb Plus Express DNA Ladder migration pattern for approximate sample migration time (page 27).
3. **Adjust** protocol time according to the expected migration time of the target fragment to the reference line.
4. **Run the gel** protocol by pressing **Start run**. The run stops automatically after the programmed time has elapsed.



Check status

1. Check the gel status by activating the Back light. Monitor the gel during the run to avoid the target fragment missing the recovery well.
2. Pause the gel when the band of interest reaches the reference line (RF) near the row of recovery wells.
Important: Put on orange Safe Imager™ viewing glasses prior to proceeding to further steps. Reduce ambient light or work in dark room for better visibility.

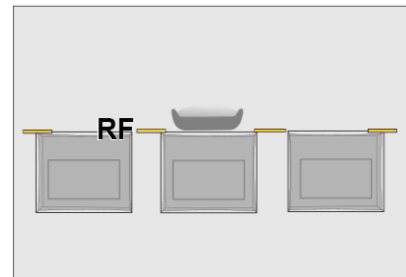

Prepare wells

1. Open the filter lid of the E-Gel™ Power Snap Electrophoresis Device and activate the Back light. The transilluminator turns off automatically when the filter lid is opened. Press **Back light** to re-activate the blue light transilluminator.
2. Load 40 μL of deionized water to all recovery wells. Do not allow water to spill over the edge of the wells.

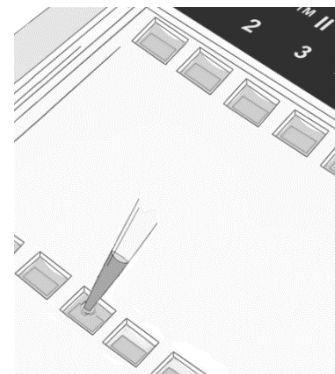

Collect DNA fragment

1. **Resume the run** and carefully observe as the band of interest fully enters the recovery well.
2. Stop the gel and recover the sample with a pipette. Avoid piercing the agarose. Some residual DNA will remain visible in the well due to migration into the agarose at the bottom of the well.
3. Proceed with downstream cloning workflow. No additional gel-purification is required.
4. (Optional) Collect additional DNA bands in the same sample from the recovery well by adding more water to the recovery well (see page 26).
5. (Optional) Use the **Reverse E-Gel** protocol if the band of interest passes the recovery well (see page 20).

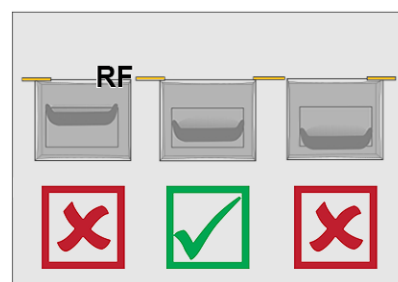

Guidelines for estimating run time

- Refer to the E-Gel™ 1 Kb Plus Express DNA Ladder migration pattern table to estimate target DNA run time to the reference line.
- The run times indicated in the table are estimates. Monitor your gel in real time during the run to ensure the sample does not pass the recovery well.
- Identically sized bands in different wells may migrate differently.
- DNA fragment size, amount, and salt content can affect migration rates.

E-Gel™ 1 Kb Plus Express DNA Ladder migration pattern

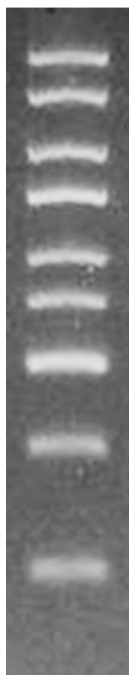
Ladder	Fragment size	DNA amount (per 25 µL)	Migration time to reference line
 <p>Size (bp)</p> <p>— 5000</p> <p>— 3000</p> <p>— 2000</p> <p>— 1500</p> <p>— 1000</p> <p>— 750</p> <p>— 500</p> <p>— 300</p> <p>— 100</p>	5000 bp	100 ng	~27.5 min
	3000 bp	100 ng	~23 min
	2000 bp	100 ng	~20.5 min
	1500 bp	160 ng	~19 min
	1000 bp	90 ng	~17 min
	750 bp	90 ng	~16 min
	500 bp	180 ng	~15 min
	300 bp	90 ng	~14 min
	100 bp	90 ng	~13 min

Troubleshooting

For common E-Gel™ troubleshooting guidelines refer to troubleshooting guide (see page 35).

Observation	Cause	Recommended action
Poor resolution or smearing of bands	Sample is overloaded	Do not load more than 800 ng of DNA in a single lane
	High salt concentration	Dilute your samples 2- to 30-fold
	Total sample volume is too low or too high	Load recommended sample volume of 25 µL per lane.
	Loading wells were not pre-filled with deionized water prior to loading the sample	Fill all gel wells with 50 µL of deionized water prior to loading any sample or a ladder.
	Samples were not prepared properly	Prepare up to 25 µL of sample in 1X concentration of 10X Sample Loading Buffer.
Low yield	Incorrect loading volume chosen	Load up to 25 µL of prepared sample per well
	Recovery wells were not filled with water prior to elution	Once target fragment reaches reference line, pause the run and fill all recover wells with deionized water.
	DNA band passed the recovery gel	Carefully observe the band migration into the recovery well. Minimize ambient light or perform the workflow in dark room.
	DNA band amount is too high	Collect DNA from the well in two or more fractions. Be sure to load the recommended DNA amount.
Target DNA band cannot be seen	High ambient light or low sample amount	Perform the workflow in dark room environment to minimize ambient lights; confirm sample concentration prior to loading
DNA band passed the recovery gel	Selected protocol time was too long	Choose the Reverse E-Gel program to run the band backwards into the collection well
DNA migration exhibits smiley effect	Extended gel run time or aged gels used or incorrect loading conditions	Do not run gels longer than 40 minutes. Use fresh gel. Follow sample loading recommendations.

E-Gel™ SizeSelect™ II gels

E-Gel™ SizeSelect™ II 2% Agarose Gels are designed for use with the E-Gel™ Power Snap Electrophoresis Device and provide a fast and convenient method for DNA fragment library size selection as part of NGS library preparation workflows.

- Advantages**
- Target fragments are collected directly from a recovery well.
 - Contains highly-sensitive SYBR™ Gold II nucleic acid stain that allows detection down to 0.5 ng/band of DNA.
- General guidelines**
- Load gel within 15 minutes of opening the pouch; run the gel immediately after loading.
 - **Important!** Always wear Safe Imager™ Viewing Glasses when viewing the gel with the filter lid opened.
 - For guidance on disposal of used gels, see SYBR™ Gold II DNA Stain (page 49).

Prepare samples

- Prepare up to 25 µL of sample in 1X Sample Loading Buffer (e.g., use 2.5 µL of 10X Sample Loading Buffer with 22.5 µL total sample). 10X Sample Loading Buffer is provided with E-Gel™ SizeSelect™ II Agarose Gels.
- **Use the indicated amount of DNA per well** for single or multiple bands.
- Do not exceed 1 µg for sheared DNA.
- Divide samples with higher amounts of DNA across multiple wells.
- Use up to 25 µL total sample volume per well.
- Dilute high salt samples (certain restriction enzyme and PCR buffers) 2- to 5-fold.

Gel type	Amount of DNA per well		Total loading volume
	Sample with single band	Sample with multiple bands	
E-Gel™ SizeSelect II	1-300 ng	500 ng	25 µL

Prepare gel

1. **Remove** the gel from the package.
2. Gently **remove** the combs. Do not allow the combs to bend or create suction in the wells during removal.
3. **Insert** gel cassette into the E-Gel™ Power Snap Electrophoresis Device, starting from the right edge.
4. Press down on the left side of the cassette to secure it into the device.



Load samples

1. Fill all wells of both rows with 50 μL of deionized water.
2. Load 25 μL of sample with 1X Sample Loading Buffer into wells from the bottom up. Do not damage the gel or introduce bubbles into the wells.
3. Load 25 μL of ready-to-use E-Gel™ Sizing DNA Ladder into a well.

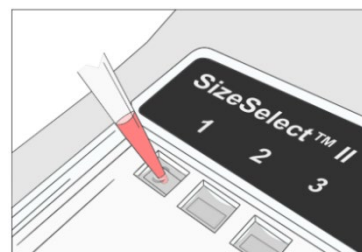

Run the gel

1. Press **Set up run**, then select the **SizeSelect 2%** protocol on E-Gel™ Power Snap Electrophoresis Device.
2. Determine the estimated run time. See the E-Gel™ Sizing DNA Ladder migration pattern for approximate sample migration time (page 31).
3. **Adjust** protocol time according to the expected migration time of the target fragment to the reference line.
4. **Run the gel** protocol by pressing **Start run**. The run stops automatically after the programmed time has elapsed.

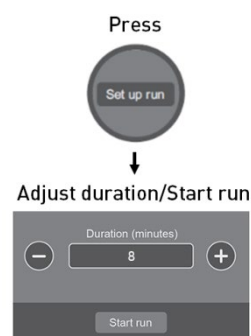

Check status

1. Check the gel status by activating the Back light. Monitor the gel during the run to avoid the target fragment missing the recovery well.
2. Pause the gel when the reference band of the DNA ladder reaches the reference line (RF) near the row of recovery wells.
Important: Put on orange Safe Imager™ viewing glasses prior to proceeding to further steps. Reduce ambient light or work in dark room for better visibility.

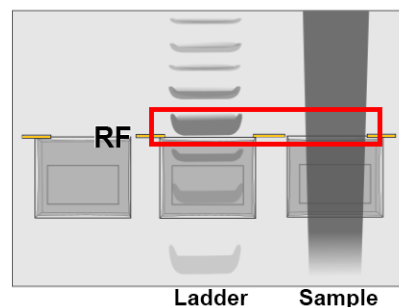

Prepare wells

1. Open the filter lid of the E-Gel™ Power Snap Electrophoresis Device and activate the Back light. The transilluminator turns off automatically when the filter lid is opened. Press **Back light** to re-activate the blue light transilluminator.
2. Carefully remove all liquid from the recovery wells.
3. Load 50 μL of nuclease-free water to all recovery wells. Do not allow water to spill over the edge of the wells.

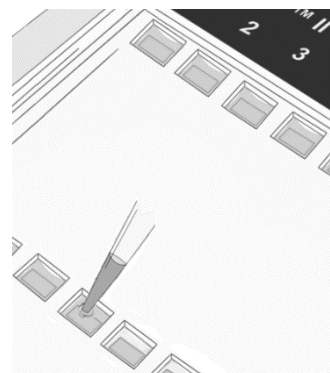

Collect DNA fragment

1. **Resume the run** and carefully observe as the reference band enters the recovery well.

Important: See NGS library size selection reference to determine when to collect samples of specific target library length.

2. Stop the gel and recover the sample with a pipette. Avoid piercing the agarose.

Some residual DNA will remain visible in the well due to migration into the agarose at the bottom of the well.

3. Proceed with downstream NGS workflow.
4. (Optional) Use the **Reverse E-Gel** protocol if the band of interest passes the recovery well (see page 20).

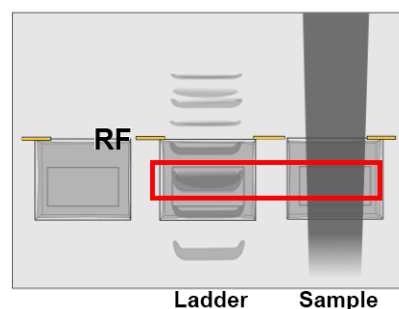















Guidelines for estimating run time

- Refer to the E-Gel™ Sizing DNA Ladder migration pattern table to estimate target DNA run time to the reference line.
- The E-Gel™ DNA Sizing Ladder is also used as a size reference marker. Refer to the NGS library size selection reference to estimate run time from the reference line to the collection well.
- The run times indicated in the table are estimates. Monitor your gel in real time during the run to ensure the sample does not pass the recovery well.
- Identically sized bands in different wells may migrate differently.
- DNA fragment size, amount, and salt content can affect migration rates.

E-Gel™ Sizing DNA Ladder migration pattern

Ladder	Fragment size	DNA amount (per 25 µL)	Migration time to reference line
	1,500 bp	1.5 ng	~19.5 min
	1,200 bp	1.5 ng	~18.5 min
	1,000 bp	6.0 ng	~17.5 min
	900 bp	2.0 ng	~17 min
	800 bp	2.0 ng	~16.5 min
	700 bp	2.0 ng	~16 min
	600 bp	2.0 ng	~15.5 min
	500 bp	6.0 ng	~14.5 min
	450 bp	2.0 ng	~14 min
	400 bp	2.0 ng	~13.5 min
	350 bp	2.0 ng	~13 min
	300 bp	2.0 ng	~12.5 min
	250 bp	2.0 ng	~11.5 min
	200 bp	6.0 ng	~11 min
	150 bp	2.0 ng	~10 min
	125 bp	2.0 ng	~9.5 min
	100 bp	2.0 ng	~9 min
	75 bp	2.5 ng	~8.5 min
	50 bp	2.5 ng	~8 min

NGS library size selection reference

Library Size	Target library peak	Runtime to reference line	Input sample amount	Stop the run and collect your sample when...	Schematic view
Ion S5™ XL System					
600-base-read	680 bp	17.5-19 min	500 ng	600 bp band has just completely entered the top edge of the collection well	
			50-100 ng	700 bp band has just completely entered the top edge of the collection well	
Ion PGM™ System					
400-base-read	480 bp	14-20 min	500 ng	500 bp band is at the top of the exposed agarose area	
			50-100 ng	500 bp band has just entered the top edge of the collection well	
300-base-read	390 bp	13-16 min	500 ng	400 bp band is at the middle of the exposed agarose area	
			50-100 ng	500 bp band is at the top of the exposed agarose area	
200-base-read	330 bp	12-14 min	500 ng	350 bp band is at the top of the exposed agarose area	
			50-100 ng	350 bp band has just completely entered the top edge of the collection well	
100-base-read	200 bp	11-12.5 min	500 ng	200 bp band is in the middle of the collection well	
			50-100 ng	200 bp band is in the middle of the collection well	
Ion Proton™ System					
200-base-read	270 bp	12-14 min	500 ng	300 bp band is at the top of the exposed agarose area	
			50-100 ng	300 bp band is at the middle of the exposed agarose area	
150-base-read	220 bp	11-14.5 min	500 ng	250 bp band is at the middle of the exposed agarose area	
			50-100 ng	250 bp band is at the middle of the exposed agarose area	

Quantitation of isolated DNA

- Recovered DNA can be assessed using the Qubit™ fluorometer (Cat. no. Q32868), or by gel electrophoresis.
- qPCR is recommended for accurate quantitation of next generation sequencing libraries recovered from E-Gel™ SizeSelect™ II gels.
- Recovered samples are not compatible with 280 nm measurements without first performing buffer exchange.

Troubleshooting

For common E-Gel™ troubleshooting guidelines refer to troubleshooting guide (see page 35).

Observation	Cause	Recommended action
Poor resolution or smearing of bands	Sample is overloaded	Do not exceed 500 ng of total DNA per one sample lane or 500 ng DNA per one band. Do not exceed 1 µg for sheared DNA
	High salt concentration	Dilute your samples 2- to 30-fold depending on the E-Gel™ type
	Total sample volume is too low or too high	Use recommended sample volume of 25 µL per lane
	Loading wells were not pre-filled with deionized water prior to loading the sample	Fill all gel wells with 50 µL of deionized water prior to loading any sample or a ladder.
	Samples were not prepared properly	Prepare up to 25 µL of sample in 1X concentration of 10X Sample Loading Buffer.
Low yield	Incorrect loading volume chosen	Load up to 25 µL of prepared sample per well
	Recovery wells were not filled with water prior to elution	Once target fragment reaches reference line, pause the run and fill all recover wells with deionized water.
	Target DNA passed the recovery gel	Carefully observe the DNA migration into the recovery well. Minimize ambient light or perform the workflow in dark room.
	DNA amount is too high	Collect DNA from the well in two or more fractions. Be sure to load the recommended DNA amount.
Target DNA band cannot be seen	High ambient light or low sample amount	Perform the workflow in dark room environment to minimize ambient lights
DNA band passed the recovery gel	Selected protocol time was too long	Choose the Reverse E-Gel program to run the band backwards into the collection well
DNA migration exhibits smiley effect	Extended gel run time or aged gels used or incorrect loading conditions	Do not run gels longer than 30 minutes. Use fresh gel. Follow sample loading recommendations.

Appendix A

Troubleshooting

Observation	Cause	Recommended action
No current	Cassette improperly inserted, defective or expired	Remove and re-insert cassette or try using new cassette. Use properly stored gels before the specified expiration date.
	Incorrect adaptor used	Use only UL Listed Class 2 Direct Plug-in Adaptor included with the E-Gel™ Power Snap Electrophoresis Device
Poor resolution or smearing of bands	Sample is overloaded	Use correct amount of sample as described in Sample Preparation.
	High salt concentration	Dilute your samples 2- to 30-fold depending on the E-Gel™ type
	Total sample volume is too low	Load recommended sample volume-based gel type. Keep all sample volumes uniform. Load deionized water in all empty wells
	Physical gel damage	Avoid touching the gel well with the pipette when loading the sample
	Band distortion caused by air bubbles	Avoid introducing bubbles while loading the samples
	Gel was not electrophoresed immediately after sample loading	Run the gel within 1 minute of sample loading.
	Gel was not loaded with the sample for an extended time	Load the opened gel within 15 minutes after opening
	Expired gel used	Use properly stored gels before the expiration date
	Gel was frozen	Always store gels at room temperature. Gels exposed to temperatures below 4°C exhibit smears
	Extended electrophoresis run time	Extended run times resulting in poor band migration or a melted gel

Observation	Cause	Recommended action
Sample leaking from the wells	Sample is overloaded	Load the recommended sample volume per well
	Wells damaged during comb removal	Remove the gel comb gently without damaging the wells
DNA sample cannot be seen	Inhibition of visualization by heat	Wait 10–15 minutes for gel to cool before visualization
RNA sample cannot be seen	Inhibition of visualization by heat and denaturing agent	Wait 10–15 minutes for gel to cool before visualization
Speckles visible	Dust fluorescing in same wavelength as SYBR™ Safe / SYBR™ Gold II	Make sure gel is clean before imaging.
High background, suboptimal, or no image (when used with E-Gel Power Snap Camera)	Incorrect camera adjustments	Refer to E-Gel Power Snap Camera use guide
High background, suboptimal, or no image (when used with E-Gel™ Imager)	No filters or wrong filter set	Refer to E-Gel™ Imager Technical Guide or instrument manufacturer for optimal filter set.
	Photographic settings not optimal	Determine optimal settings empirically by adjusting exposure time, gain, etc.
	E-Gel™ agarose gels with ethidium bromide are not compatible for visualization on a blue light transilluminator	Use an E-Gel™ Imager with UV base or a 3 rd -party UV transilluminator
Low cloning efficiency	Used a UV light source to visualize DNA	For cloning applications, use E-Gel™ CloneWell™ II Agarose Gels with SYBR Safe; or for gel excision use a blue light transilluminator, such as the Safe Imager™ 2.0 Blue-Light Transilluminator (Cat. no. G6600).

System maintenance

Repeated instrument use can result in formation of spots and smudges on the glass over the transilluminator and on the amber filter, which can then decrease image quality. Clean the glass over the transilluminator and amber filter as needed.

Materials required

- Safety glasses
- Powder-free gloves
- Tissue, lint-free
- Deionized water
- Ethanol, 70% solution

Note: Avoid the use of detergents. Ensure the instrument is switched off and unplugged before cleaning.

Cleaning

1. Open the filter lid to expose the cassette compartment.
2. Lightly spray the glass surface with deionized water or a 70% ethanol solution.
3. Wipe the surface with a lint-free tissue until sufficiently clean.
4. Close the filter lid and operate the instrument as normal.

Upgrade system firmware

1. Download the latest firmware file from thermofisher.com to your PC.
2. Unzip and transfer the firmware upgrade files to a USB storage device.
3. Insert the USB storage device into a USB port on the instrument.
 - a. Use the port located at the back of the E-Gel™ Power Snap Electrophoresis Device (A) to upgrade the electrophoresis unit.
 - b. Use the port located at the front of the E-Gel™ Power Snap Camera (B) to upgrade the camera.
4. Press **Settings** / , then select **Software update**. The instrument will search for the update files in the USB storage device.
5. Select **Update**. The instrument will automatically install the new software. Installation takes 1–2 minutes. The instrument reboots after software installation is complete.

Important: do not power off the instrument during software installation.
6. After installation is complete, remove the the USB storage device.
7. Switch the instrument **off**, then after a few seconds, switch the instrument **on** again.
8. Verify that the updated software is installed by pressing **Settings** / , then select **About instrument**.

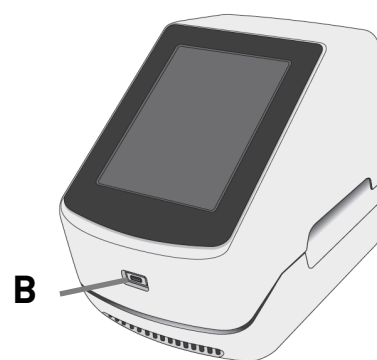

Battery replacement

The E-Gel™ Power Snap Camera contains a 3 V CR2450 battery which is required to record the file date and time for the captured images.

When battery runs out, the system will indicate the need to replace it.

1. Open the battery compartment on the underside of the E-Gel™ Power Snap Camera.
2. Place the battery compartment cover to one side.
3. Remove and replace the old battery.
4. Replace the battery compartment cover and close the battery compartment.

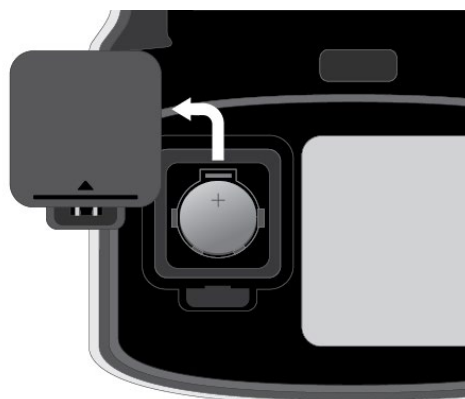

Instrument Specifications

Instrument dimensions and specifications

Specification	E-Gel Power Snap Electrophoresis Device
Dimensions	242 mm × 130 mm × 70 mm
Weight	1 kg
Touchscreen LCD display	77.4 mm × 43.86 mm
Viewing surface dimensions	90 mm × 110 mm
Amber filter dimensions	86 mm × 105 mm
LED light	Blue LED (CWL: 465 nm, FWHM: 20 nm)
LED life	50,000 hours
LED specification	Array of 12 high power LEDs emitting at 465 +/- 10 nm

Specification	E-Gel Power Snap Camera
Dimensions	259 mm × 130 mm × 152 mm
Weight	1 kg
Internal memory	32 GB
Touchscreen LCD display	115.2 mm × 86.4 mm
Camera type	color CMOS
Gel image resolution	1600 × 1944 (3MP), 8 bits
Dynamic range	68dB
Image output	.tif (Grayscale) and .jpg (Color)
Lens f/number	2.8

Electrical requirements

Warning: For safety, the power outlet used for powering the instrument must be accessible at all times. In case of emergency, you must be able to immediately disconnect the main power supply to the instrument. Allow adequate space between the wall and the equipment so the power cord can be disconnected in case of emergency.

- Electric receptacle with grounding capability
- Maximum power dissipation: ~90 W
- Mains AC line voltage tolerances must be up to ± 10 percent of nominal voltage

	Rated Voltage (Input)	Rated Current (Input)	Rated Frequency (Input)	Rated Power (Output)
AC/DC Power Supply	100–240 VAC $\pm 10\%$	1.3 A	50/60 Hz	90 W
E-Gel™ Power Snap Electrophoresis Device	48 VDC $\pm 2.5\%$	1.87 A	N/A	N/A
E-Gel™ Power Snap Camera	Does not function as a standalone device. Powered from E-Gel™ Power Snap Electrophoresis Device.			

Environmental requirements

Condition	Acceptable Range
Installation site	Indoor use only
Electromagnetic interference	Do not use this device in close proximity to sources of strong electromagnetic radiation (for example, unshielded intentional RF sources). Strong electromagnetic radiation may interfere with the proper operation of the device.
Altitude	Between sea level and 2000 m (6500 ft.) above sea level
Operating conditions	<ul style="list-style-type: none"> • Humidity: 15–80% relative humidity (noncondensing) • Temperature: 15 to 30°C (59 to 86°F) Note: For optimal performance, avoid rapid or extreme fluctuations in room temperature.
Storage and transport conditions	<ul style="list-style-type: none"> • Humidity: 20–80% relative humidity (noncondensing) • Temperature: –30 to 60°C (–22 to 140°F)
Thermal output	During operation, the net thermal output, based on the actual current draw of the instrument, is expected to be approximately 72 W (245.67 Btu/h).
Vibration	Ensure that the instrument is not adjacent to strong vibration sources, such as a centrifuge, pump, or compressor. Excessive vibration will affect instrument performance.
Pollution degree	The instrument has a Pollution Degree rating of II. The instrument may only be installed in an environment that has nonconductive pollutants such as dust particles or wood chips. Typical environments with a Pollution Degree II rating are laboratories and sales and commercial areas. The noise output of the instrument is ≤ 45 dB(A) when running.
Other conditions	Ensure the instrument is located away from any vents that could expel particulate material onto the instrument components. Avoid placing the instrument adjacent to heaters, cooling ducts, or in direct sunlight.

E-Gel™ agarose gels

E-Gel™ agarose gels are precast bufferless gels with electrodes embedded in the agarose matrix. Each gel contains an ion generating system, a pH balancing system, and DNA stain packaged inside a transparent plastic cassette. Each gel cassette contains two ion exchange matrices (IEMs) that are in contact with the gel and electrodes. The IEMs supply a continuous flow of ions throughout the gel resulting in a sustained electric field required for running the gel.

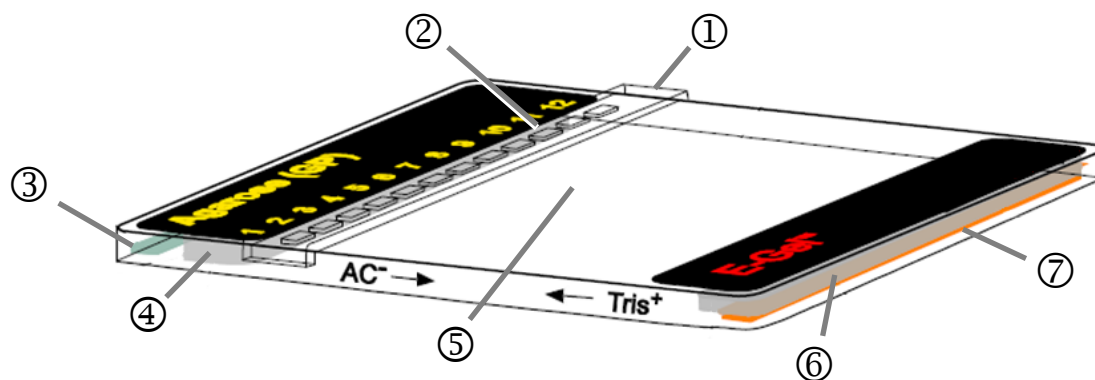

- ① Comb
- ② Sample wells
- ③ Upper ion exchange matrix
- ④ Cathode (-)

- ⑤ Agarose gel
- ⑥ Lower ion exchange matrix
- ⑦ Anode (+)

Choosing the right gel

To obtain the best results for your application, it is important to choose the correct agarose percentage and well format. The tables below list the various types of gel and resolution for each gel type.

Analytical gels

	E-Gel™ EX Agarose Gels	E-Gel™ EX Double Comb Agarose Gels	E-Gel™ SYBR™ Safe Agarose Gels	E-Gel™ Double Comb SYBR™ Safe Agarose Gels	E-Gel™ Go! Agarose Gels
Application	Fast separation and high sensitivity sample analysis		Routine gel separation		For very low sample throughput
No rows	1 row	2 rows	1 row	2 rows	1 row
Loading wells	11 wells	22 wells	12	22 wells	4
Loading volume	20 µL	20 µL	20 µL	20 µL	10 µL
Stain	SYBR™ Gold II	SYBR™ Gold II	SYBR™ Safe	SYBR™ Safe	SYBR™ Gold II
Detection sensitivity	0.5 ng/band	0.5 ng/band	3 ng/band	3 ng/band	0.5 ng/band
% Agarose	1%, 2%, 4%	1%, 2%	1%, 2%, 4%	1%, 2%	1%, 2%
Separation range	1%: 100 bp - 5kb 2%: 50 bp - 2kb 4%: 10 bp - 500bp	1%: 100 bp - 5kb 2%: 50 bp - 2kb	1%: 100 bp - 5kb 2%: 50 bp - 2kb 4%: 10bp - 500bp	1%: 100 bp - 5kb 2%: 50 bp - 2kb	1%: 100 bp - 4kb 2%: 50 bp - 2kb
Run time	1%, 2%: 10-20min 4%: 15-20min	1%, 2%: 5-8min	1%, 2%: 26-40min 4%: 30-40min	1%, 2%: 13-15min	15-30min
Access to sample	Yes (openable)				No

Gels for preparative gel electrophoresis in Cloning and NGS applications

	E-Gel™ CloneWell II	E-Gel™ Size Select II	E-Gel™ NGS
Application	Target fragment isolation in cloning workflow	Low range fragment library size selection in NGS workflow	High range fragment library size selection
No rows	2 rows: 1 loading row and 1 recovery row	2 rows: 1 loading row and 1 recovery row	1 row with sample loading wells
Loading wells	7	7	10 + 1 marker lane
Loading volume	25 µL	25 µL	20 µL
Stain	SYBR™ Safe	SYBR™ Gold II	SYBR™ Safe
Detection sensitivity	3 ng / band	0.5 ng / band	3 ng / band
% Agarose	0.8%	2%	0.8%
Separation range	100 bp - 6 kb	50 bp - 2 kb	800 bp - 10 kb
Run time	12-40 min	8-20 min	26-32 min
Access to sample	Sample recovered via elution wells	Sample recovered via elution wells	Openable cassette. Manual gel excision.

Other available gel types for routine electrophoresis

E-Gel™ EX Agarose Gels can be used to run RNA samples. RNA can be run under denaturing or non-denaturing conditions. Use non-denaturing conditions only when checking for RNA quality, where accurately determining size is not critical. See page 46 for instructions on performing electrophoresis of RNA samples.

Opening E-Gel™ cassettes

- Electrophoresis must be complete before opening the E-Gel™ cassette.
- Photograph the gel before opening the cassette.
- If you plan to isolate DNA from the E-Gel™ agarose gel, open the cassette and excise the gel fragment immediately after electrophoresis as bands will diffuse within 20 minutes.
- If you plan to blot the gel, prepare your blotting apparatus before opening the cassette.
- **Important!** Before opening the E-Gel™ cassette, put on safety goggles and gloves.

Gel Knife

The Gel Knife (Cat. no. EI9010) is used to open the cassette for E-Gel™ EX and E-Gel™ NGS agarose gels.

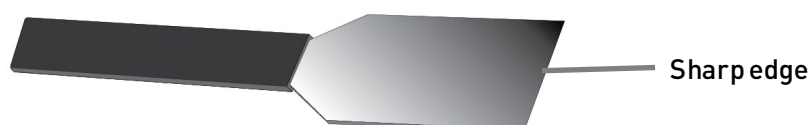

Open E-Gel™ EX and NGS cassettes with a Gel Knife

1. Place the cassette on a flat surface, with the wells facing upward.
2. **Insert** the sharp edge of the gel knife into the groove around the edge of the cassette edge, then lever the knife up and down to crack the seal.
3. **Unseal** the plate by working around the perimeter of the entire cassette and cracking the seal for every edge.
4. Remove the top of the gel cassette after all four sides of the cassette are unsealed.
5. Proceed to downstream application.

If you plan to transfer DNA from the gel by blotting, only the main running gel is required. Remove the upper and lower ion exchange matrix layers and the well areas with the Gel Knife.

If you plan to purify DNA from the gel, excise the gel fragment. Transfer the gel slice to a microcentrifuge tube.

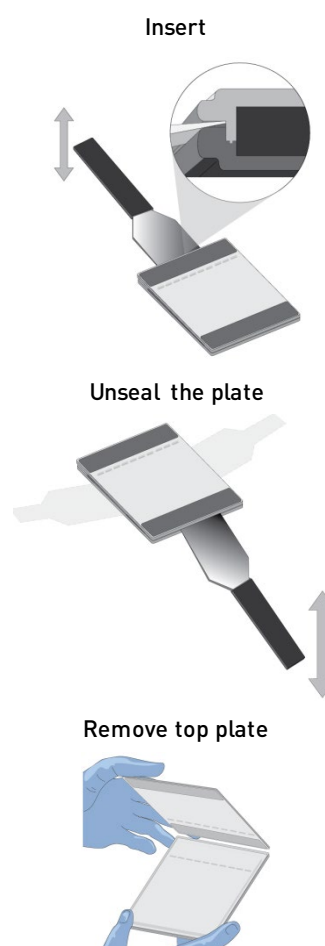

Cleaning and storage

After use, clean the E-Gel™ Opener with mild detergent and water to remove any excess agarose, and plastic from the platform. Use a squirt bottle and wipe the platform dry with a clean tissue. Do not insert your fingers into the area housing the blades, and do not immerse the E-Gel™ Opener in water as the blades may rust. Store the E-Gel™ Opener at room temperature.

E-Gel™ Opener

The E-Gel™ Opener is specifically designed to open any E-Gel™ single comb, double comb, or E-Gel™ with SYBR™ Safe cassette so the gel can be removed for staining, excision of DNA fragments, or blotting.

The E-Gel™ Opener consists of an anodized aluminum platform housing two recessed steel blades, one which is stationary and one which is movable.

Before using the E-Gel™ Opener for the first time, we recommend that you practice opening a few used E-Gels™ that will not be used further for preparative purposes to familiarize yourself with the process.

Caution! The blades on the E-Gel™ Opener are extremely sharp. **DO NOT INSERT YOUR FINGERS INTO THE AREA BETWEEN THE BLADES!** Pick up the E-Gel™ Opener by holding the large knob only (see figure above). Exercise caution when handling and cleaning the E-Gel™ Opener. Dispose of blades in a needle disposal container or a sharps disposal box.

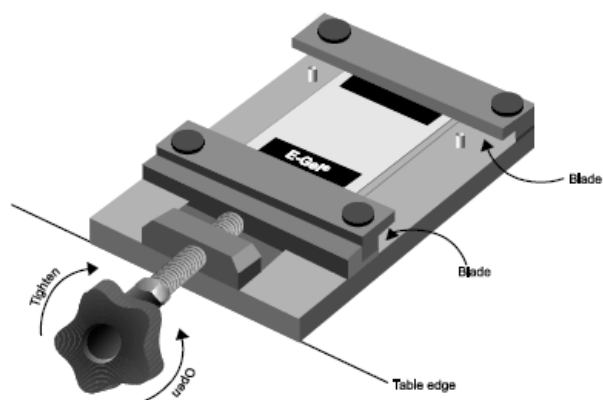

Open the E-Gel™ cassette with an E-Gel™ Opener

1. Place the E-Gel™ Opener on a flat surface, with the knob extending off the edge of the laboratory bench and facing the user.
2. Set the E-Gel™ Opener to its widest open position by turning the knob counterclockwise.
3. Insert the E-Gel™ into the E-Gel™ Opener so that two opposing sides of the gel cassette are aligned with the blades. Position the cassette such that the two sides fit into the grooves housing the blades.
4. Turn the knob clockwise to bring the blades in contact with the cassette. As the knob is tightened, you will hear a series of pops.
5. Continue to turn the knob until the resistance increases. Stop turning the knob as soon as the cassette begins to lift off the surface of the platform. Two sides of the cassette will now be unsealed.

Note: Once you observe the cassette begins to lift off the surface of the platform, do not continue to tighten the knob as you will damage the E-Gel™ agarose gel.

6. Unscrew the knob and remove the cassette. You may have to carefully work the cassette from the housing because the cassette fits snugly in the recessed groove
7. Turn the cassette 90° and re-insert the cassette into the E-Gel™ Opener to open the two remaining sides.
8. Repeat steps 4–5 to break the two remaining seals.
9. Unscrew the knob and carefully remove the E-Gel™ cassette. The 4 sides of the cassette should be unsealed. If not, repeat Steps 2–5 as necessary.

Cleaning and storage

After use, clean the E-Gel™ Opener with mild detergent and water to remove any excess agarose and plastic from the platform. Use a squirt bottle and wipe the platform dry with a clean tissue. Do not insert your fingers into the area housing the blades, and do not immerse the E-Gel™ Opener in water as the blades may rust. Store the E-Gel™ Opener at room temperature.

E-Gel™ agarose gel disposal guidelines

- Discard E-Gel™ EX Agarose Gels, E-Gel™ SizeSelect™ Agarose Gels, and E-Gel™ Go! Agarose Gels as hazardous waste.
- SYBR™ Safe stain is not classified as hazardous waste under US Federal regulations, but contact your safety office for appropriate disposal methods (see page 48).

Appendix D

Choosing the right DNA ladder

Use the following table to select the E-Gel™ DNA ladder that yields the best resolution for your E-Gel™ agarose gel.

		E-Gel™ 1 Kb Plus DNA Ladder	E-Gel™ 1 Kb Plus Express DNA Ladder	E-Gel™ 50 bp DNA Ladder	E-Gel™ 96 High Range DNA Marker	E-Gel™ Low Range Quantitative DNA Ladder	E-Gel™ Ultra Low Range DNA Ladder	Millenium RNA Marker	Century-Plus RNA Ladder	E-Gel™ Sizing DNA Ladder
Gel Type	% Agarose	(Cat. No. 10488090)	(Cat. No. 10488091)	(Cat. No. 10488099)	(Cat. No. 12352019)	(Cat. No. 12373031)	(Cat. No. 10488096)	(Cat. No. AM7150)	(Cat. No. AM7145)	(Cat. No. 10488100)
E-Gel™ Agarose Gels w/ SYBR™ Safe DNA Stain	1%	●								
	2%			●						
	4%						●			
E-Gel™ Double Comb Agarose Gels w/ SYBR™ Safe DNA Gel Stain	1%		●		●					
	2%		●			●				
E-Gel™ EX Gels	1%	●						●		
	2%			●					●	
	4%						●		●	
E-Gel™ EX Double Comb Agarose Gels	1%		●		●					
	2%			●	●					
E-Gel™ Go! Agarose Gels	1%		●							
	2%			●						
E-Gel™ CloneWell™ II	0.8%		●							
E-Gel™ SizeSelect™ II	2%									●
E-Gel™ NGS	0.8%	●	●							

● Recommended DNA ladder

Running RNA Samples on E-Gel™ EX Agarose Gels

E-Gel™ EX Agarose Gels can be used to run RNA samples. RNA can be run under denaturing or non-denaturing conditions. Use non-denaturing conditions only when checking for RNA quality, where accurately determining size is not critical.

Important: Using other denaturing agents like Glyoxal, Formaldehyde, or Urea results in very poor separation and band morphology on E-Gel™ EX.

It is not recommended to run samples that were loaded with RNA loading buffer on the same gel as samples that are loaded with water.

Non-denaturing conditions

- Mix RNA sample with RNase-free water such that the final volume is 20 µL.
- Do not heat. Load the entire sample onto the E-Gel™ EX.
- Run RNA using the E-Gel™ EX 1–2% program for 10 minutes.

Denaturing agents

The only denaturing agent that is compatible with the E-Gel™ EX system is Formamide, 50–95%. Lower concentrations are also acceptable.

Denaturing conditions

There are two methods for denaturing your RNA sample to run on an E-Gel™ EX Agarose Gel.

Method 1

1. Mix RNA (250 ng–2 µg) sample with formamide (to 50–95%) such that the final volume is 20 µL.
2. Heat samples at 65°C for 5 minutes to denature RNA.
3. Place samples on ice immediately after heating.
4. Load entire sample onto E-Gel™ EX.
5. Run RNA using the E-Gel™ EX 1–2% program for 10 minutes.

Method 2

1. Mix RNA (250 ng–2 µg) sample with RNase-free water or loading buffer such that the final volume is 20 µL.
2. Heat samples at 65°C for 5 minutes to denature RNA

E-Gel™ Power Snap Blue-Light Transilluminator

To monitor sample separation right at laboratory bench, the E-Gel™ Power Snap Electrophoresis Device has an integrated blue-light LED source with emission maximum at 465 nm. This enables real-time monitoring of samples running on E-Gel™ agarose gels that are pre-stained with SYBR Safe™ or SYBR Gold II DNA stains.

The light from a LED source within the transilluminator passes through a blue filter producing a single intensity signal at approximately 465 nm, effective for the excitation of SYBR™ DNA-binding dyes such as SYBR™ Safe DNA gel stain and SYBR Gold. Sensitivity obtained using this instrument is comparable to that obtained with a standard UV transilluminator.

The E-Gel™ Power Snap Electrophoresis Device transilluminator is designed for viewing E-Gel™ with SYBR™ Safe gels, E-Gel™ EX gels, E-Gel™ CloneWell™ II gels, E-Gel™ SizeSelect™ II, and E-Gel™ Go! gels.

The use of blue-light transillumination is advantageous over the UV, as it does not require UV protective equipment during use. In preparative gel electrophoresis blue-light transillumination results in dramatically increased cloning efficiencies compared to UV transillumination.

Important! Do not look directly at blue-light transilluminator surface. Make sure the filter lid is closed when the blue light is on. When working with opened filter cover, always use E-Gel™ Safe Imager™ viewing glasses.

Emission spectra for the Safe Imager™ Blue-Light Transilluminator

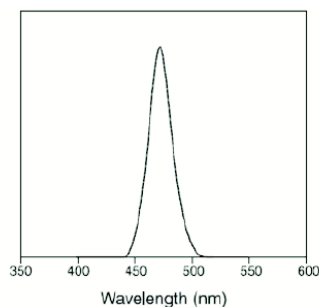

Imaging E-Gels on Third Party Gel Imagers

For E-Gel™ agarose gel imaging on other commercially available imaging devices follow user guides provided by the supplier. Instruments with an excitation source in the UV range or between 470–530 nm may also be used with the proper filter. Contact your instrument manufacturer for advice.

Nucleic acid stain use in E-Gel™ agarose gels

SYBR™ Safe DNA Gel Stain

SYBR™ Safe DNA gel stain has been specifically developed for reduced mutagenicity, making it safer than ethidium bromide for staining DNA in agarose gels. The detection sensitivity of E-Gel™ with SYBR™ Safe stain is similar to that of E-Gel™ containing ethidium bromide. DNA bands stained with SYBR™ Safe DNA gel stain can be detected by standard UV transillumination, visible-light transillumination, or laser-scanning.

Safety features

SYBR™ Safe DNA gel stain is not classified as hazardous waste under US Federal regulations.

- Meets the requirements of the Clean Water Act and the National Pollutant Discharge Elimination System regulations.
- Does not induce transformations in primary cultures of Syrian hamster embryo (SHE) cells.
- Does not cause mutations in mouse lymphoma cells at the TK locus, nor does it induce chromosomal aberrations in cultured human peripheral blood lymphocytes, with or without S9 metabolic activation.
- Causes fewer mutations in the standard Ames test compared to ethidium bromide. Weakly positive results occurred in only four out of seven Salmonella strains, and only with activation by a mammalian S9 fraction.
- Produces no signs of mortality or toxicity at a limit dose of 5000 mg/kg from a single oral administration.

View studies documenting the safety of SYBR™ Safe in the SYBR™ Safe White Paper document, available from thermofisher.com/content/dam/LifeTech/global/life-sciences/pdfs/494.pdf

Cloning benefits

By using the blue light transillumination for visualization, DNA damage is dramatically reduced, thus improving cloning efficiency. For more information, go to: thermofisher.com/sybrsafe

Disposal

SYBR™ Safe DNA gel stain is not classified as hazardous waste, but because disposal regulations vary, please contact your safety office or local municipality for appropriate SYBR™ Safe disposal in your community.

Spectrum

Bound to nucleic acids, SYBR™ Safe stain has fluorescence excitation maxima at 280 and 502 nm, and an emission maximum at 530 nm (see following figure).

Normalized fluorescence excitation and emission spectra of SYBR™ Safe DNA gel stain, determined in the presence of DNA.

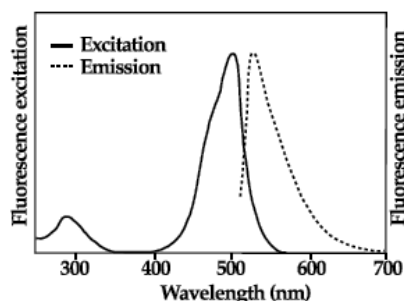

Visualization

For quick visualization and documentation of SYBR™ Safe stained E-Gel™ agarose gels use E-Gel™ Power Snap Camera.

Alternatively, use a blue light transilluminator or a standard UV transilluminator. The UV excitation range is not optimal for SYBR Safe stain, therefore gels visualized on UV transilluminator will provide lower sensitivity.

SYBR™ Gold II Gel Stain

SYBR™ Gold II gel stain has been specifically developed for E-Gel™ EX, E-Gel™ SizeSelect™ II and E-Gel Go! agarose gels. This gel stain has high sensitivity, with detection down to 0.5 ng/band of DNA. This fluorescent nucleic acid stain can be viewed by blue light transilluminator, significantly reducing DNA damage that can reduce cloning efficiency.

Disposal

Dispose E-Gel™ EX, E-Gel™ SizeSelect™ and E-Gel™ Go! agarose gels as hazardous waste in the same manner as ethidium bromide containing gels. Contact your safety office or local municipality for appropriate disposal in your community.

Spectrum

When bound to nucleic acids, the proprietary nucleic acid stain in E-Gel™ EX, E-Gel™ SizeSelect™ and E-Gel™ Go! agarose gels has fluorescence excitation maxima at 490 nm, and an emission maximum at 522 nm (see figure below).

Normalized fluorescence excitation and emission spectra of proprietary DNA gel stain in E-Gel™ EX, E-Gel™ SizeSelect™ and E-Gel™ Go! agarose gels, determined in the presence of DNA.

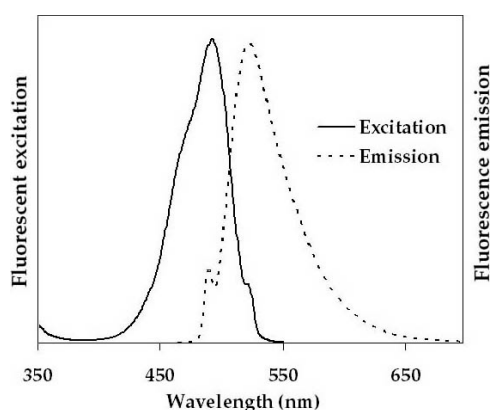

Visualization

For quick visualization and documentation of SYBR™ Gold II stained E-Gel™ agarose gels use E-Gel™ Power Snap Camera.

Alternatively, use a blue light transilluminator or a standard UV transilluminator.

Appendix G

Instrument starter kits

E-Gel™ Power Snap Electrophoresis Device Starter Kit Included Equipment																																									
Cat. No.	E-Gel™ Power Snap Electrophoresis Device	E-Gel™ Power Snap Camera	Power Cord w/ Adaptor	Safe Imager Viewing Glasses (Cat. No. S37103)	Gel Knife																																				
G8141ST	1 each	—	1 each	1 each	1 each																																				
G8142ST					—	1 each	1 each	—																																	
G8151ST									—	1 each	1 each	—																													
G8152ST													—	1 each	1 each	—																									
G8168ST																	—	1 each	1 each	—																					
G8162ST																					—	1 each	1 each	—																	
G8131ST																									—	1 each	1 each	—													
G8132ST																													—	1 each	1 each	—									
G8171ST																																	—	1 each	1 each	—					
G8172ST																																					—	1 each	1 each	—	
G8341ST		1 each																																							1 each
G8342ST					1 each			1 each																																	
G8351ST		1 each							1 each			1 each																													
G8352ST					1 each								1 each			1 each																									
G8331ST		1 each															1 each			1 each																					
G8332ST					1 each																1 each			1 each																	
G8371ST	1 each	1 each	1 each	—																																					
G8372ST					1 each	1 each	1 each																		—																

E-Gel™ Power Snap Electrophoresis Device Starter Kit Included Reagent List								
Cat. No.	E-Gel™ Agarose Gel		Ladders				E-Gel™ Low Range Quant. DNA Ladder	E-Gel™ Sizing DNA Ladder
	Type	# of Gels	E-Gel™ 1Kb Plus Express DNA Ladder	E-Gel™ 1Kb Plus DNA Ladder	E-Gel™ 50 bp DNA Ladder	E-Gel™ 96 High Range DNA Marker		
G8141ST	E-Gel™ EX Gel, 1%	10	100 apps.	—	—	—	—	—
G8142ST	E-Gel™ EX Gel, 2%	10	—	—	100 apps.	—	—	—
G8151ST	E-Gel™ SYBR™ Safe Gel, 1%	18	—	100 apps.	—	—	—	—
G8152ST	E-Gel™ SYBR™ Safe Gel, 2%	18	—	—	100 apps.	—	—	—
G8168ST	E-Gel™ CloneWell II Gel, 0.8%	10	100 apps.	—	—	—	—	—
G8162ST	E-Gel™ SizeSelect II Gel, 2%	10	—	—	—	—	—	100 apps.
G8131ST	E-Gel™ EX Double Comb 1%	10	100 apps.	—	—	100 apps.	—	—
G8132ST	E-Gel™ EX Double Comb 2%	10	—	—	100 apps.	—	100 apps.	—
G8171ST	E-Gel™ DC with SYBR™ Safe 1%	10	100 apps.	—	—	100 apps.	—	—
G8172ST	E-Gel™ DC with SYBR™ Safe 2%	10	100 apps.	—	—	—	100 apps.	—
G8341ST	E-Gel™ EX Gel, 1%	10	100 apps.	—	—	—	—	—
G8342ST	E-Gel™ EX Gel, 2%	10	—	—	100 apps.	—	—	—
G8351ST	E-Gel™ SYBR™ Safe Gel, 1%	10	—	—	—	—	—	—
G8352ST	E-Gel™ SYBR™ Safe Gel, 2%	10	—	100 apps.	—	—	—	—
G8331ST	E-Gel™ EX Double Comb 1%	18	—	—	100 apps.	—	—	—
G8332ST	E-Gel™ EX Double Comb 2%	18	—	—	100 apps.	—	100 apps.	—
G8371ST	E-Gel™ DC with SYBR™ Safe 1%	10	100 apps.	—	—	100 apps.	—	—
G8372ST	E-Gel™ DC with SYBR™ Safe 2%	10	100 apps.	—	—	—	100 apps.	—

E-Gel™ agarose gels

Refer to **Choosing the right gel** (page 41) to select the most suitable gel for your application.

Products	% Agarose	Quantity	Catalog No.
E-Gel™ EX Agarose Gels	1%	10 gels	G401001
		20 gels	G402001
	2%	10 gels	G401002
		20 gels	G402002
	4%	10 gels	G401004
	E-Gel™ Agarose Gels with SYBR™ Safe	1%	10 gels
20 gels			A45202
50 gels			A45203
2%		10 gels	A42135
		20 gels	A45204
		50 gels	A45205
4%		10 gels	A42136
		20 gels	A45206
E-Gel™ EX Double Comb		1%	10 gels
	2%	10 gels	A42346
E-Gel™ Double Comb w/ SYBR™ Safe 1%	1%	10 gels	A42347
	2%	10 gels	A42348
E-Gel™ Go! Agarose Gels	1%	10 gels	G441001
		20 gels	G442001
	2%	10 gels	G441002
		20 gels	G442002
E-Gel™ NGS Agarose Gels	0.8%	10 gels	A25798
E-Gel™ CloneWell™ II Agarose Gels	0.8%	10 gels	G661818
E-Gel™ SizeSelect™ II Agarose Gels	2%	10 gels	G661012

Accessory products

E-Gel DNA Ladders	Quantity	Applications	Catalog No.
E-Gel™ 1 Kb Plus DNA Ladder (25 ng/μL)	2 x 1 mL	100 apps	10488090
E-Gel™ 1 Kb Plus Express Ladder (40 ng/μL)	2 x 1.25 mL	100 apps	10488091
E-Gel™ 50 bp DNA Ladder (25 ng/μL)	2 x 1 mL	100 apps	10488099
E-Gel™ Sizing DNA Ladder (2 ng/μL)	2 x 1.25 mL	100 apps	10488100
E-Gel™ Low Range Quantitative DNA Ladder (17.5 ng/μL)	1 mL	100 apps	12373031
E-Gel™ Ultra Low Range DNA Ladder (25 ng/μL)	2 x 1 mL	100 apps	10488096
E-Gel™ 96 High Range DNA Marker (5 ng/μL)	2 x 1 mL	100 apps	12352019
E-Gel Sample Loading Buffer, 1X	4 x 1.25 mL	—	10482055

Accessory items

Product	Quantity	Catalog No.
Safe Imager™ Viewing Glasses	1 each	S37103
Gel Knife	1 each	E19010
E-Gel Opener	1 each	G530001

Safety

Before starting

Before you begin using this product, or any installation or service operation, please read the following safety information. Attention to these warnings will help prevent personal injuries and damage to the products.

It is your responsibility to use the product in an appropriate manner. This product is designed for use solely in laboratory environments, and must not be used in any way that may cause personal injury or property damage.

You are responsible if the product is used for any intention other than its designated purpose or in disregard of Thermo Fisher Scientific instructions. Thermo Fisher Scientific shall assume no responsibility for such use of the product.

The product is used for its designated purpose if it is used in accordance with its product documentation and within its performance limits.

Using the product requires technical skills and a basic knowledge of English. It is therefore essential that only skilled and specialized staff or thoroughly trained personnel with the required skills be allowed to use the product.

Keep the basic safety instructions and the product documentation in a safe place and pass them on to the subsequent users.

Applicable local or national safety regulations and rules for the prevention of accidents must be observed in all work performed.

Operation of the E-Gel™ Power Snap Electrophoresis System is subject to the following conditions:

- Indoor use.
- Altitude below 2000 meters.
- Temperature range: 5 to 30°C.
- Maximum relative humidity: 80% (maximum relative humidity 80% for temperatures up to 31°C, decreasing linearly to 50% relative humidity at 40°C).
- Installation categories (over voltage categories) II; Pollution degree 2
- Mains supply voltage fluctuations not to exceed 10% of the nominal voltage (100–240 V, 50/60 Hz, 1.3 A).
- Mains plug is a disconnect device and must be easily accessible.
- Do not attempt to open the E-Gel™ Power Snap Electrophoresis System. To honor the warranty, the E-Gel™ Power Snap Electrophoresis System can only be opened and serviced by Thermo Fisher Scientific.
- The protection provided by the equipment may be impaired if the equipment is used in a manner not specified by Thermo Fisher Scientific.
- The device must be connected to a mains socket outlet with protective earthing connections.
- Ventilation requirements: room ventilation.

Installing the instrument

The product may be installed only under the conditions and in the positions specified by Thermo Fisher Scientific.

Following are the required operating position and conditions:

- Do not place the product in an area where it will be subject to vibration.
- Do not place the product on surfaces, vehicles, cabinets or tables that for reasons of weight or stability are unsuitable for this purpose.
- Do not place the product on heat-generating surface or near heat emitting devices such equipment racks or heaters. Verify that there is sufficient clearance between the product and any other system that may exhaust warm air.
- The product's ventilation should not be obstructed. If proper ventilation is not provided it can result in electric shock, fire and/or serious personal injury or death.
- The product is for indoor use only
- Use only with suitably rated mains supply cord (having 3 conductors min. 16 AWG or 1.5 mm², min. 300V, Harmonized Type for Europe and UL Listed/CSA Certified for North America, with molded plug rated min. 10A).
- A tolerance of $\pm 10\%$ shall apply to the nominal input voltage and ± 3 Hz to the nominal frequency, overvoltage category 2.
- Maximum operating altitude 2000 m asl, Maximum transport altitude 4500 m asl.

Electromagnetic compatibility (EMC) standards

Class A notice

This equipment has been tested and found to comply with the limits for a Class A digital device, pursuant to part 15 of the FCC Rules. These limits are designed to provide reasonable protection against harmful interference when the equipment is operated in a commercial environment. This equipment generates, uses, and can radiate radio frequency energy and, if not installed and used in accordance with the instruction manual, may cause harmful interference to radio communications.

Electrical safety

The following information on electrical safety must be observed, failing to follow these instructions may result in electric shock, fire and/or serious personal injury or death.

Service operation requirements

In the event of an equipment malfunction, it is the responsibility of the customer to report the need for service to Thermo Fisher Scientific or to one of the authorized agents. For service information, contact Technical Support (page 58).

Servicing of this device is to be performed by trained service personnel only.

- Prior to switching on the product, ensure that the nominal voltage setting on the product matches the nominal voltage of the AC supply network.
- This product should be connected to the power mains using a 3-wire (two conductors and ground) power cable and plug. Use this power cable with a properly grounded electrical outlet to avoid electrical shock.
- If extension cords or connector strips are implemented, they must be checked on a regular basis to ensure that they are safe to use.
- The appliance coupler of the connecting cable is regarded as the disconnecting device. In such cases, always ensure that the power plug is easily reachable and accessible at all times (corresponding to the length of connecting cable, approx. 2 m).
- Never use the product if the power cable is damaged. Check the power cable on a regular basis to ensure that it is in proper operating condition. By taking appropriate safety measures and carefully laying the power cable, you can ensure that the cable will not be damaged and that no one can be hurt by, for example, tripping over the cable or suffering an electric shock.
- Do not insert the plug into sockets that are dusty or dirty. Insert the plug firmly and all the way into the socket. Otherwise, sparks that result in fire and/or injuries may occur.
- Do not overload any sockets, extension cords or connector strips; doing so can cause fire or electric shocks.
- Ensure that the connections with information technology equipment, e.g. PCs or other industrial computers, comply with the IEC60950-1/EN60950-1 or IEC61010-1/EN 61010-1 standards that apply in each case.
- Unless expressly permitted, never remove the cover or any part of the housing while the product is in operation. Doing so will expose circuits and components and can lead to injuries, fire or damage to the product.
- Use suitable overvoltage protection to ensure that no overvoltage (such as that caused by a bolt of lightning) can reach the product. Otherwise, the person operating the product will be exposed to the danger of an electric shock.
- The overvoltage protection should limit the magnitude of the overvoltage surge to 1kV between the any of the power line and ground.
- Any object that is not designed to be placed in the openings of the housing must not be used for this purpose. Doing so can cause short circuits inside the product and/or electric shocks, fire or injuries.
- Prior to cleaning the product, disconnect it completely from the power supply. Use a soft, non-linting cloth to clean the product. Never use chemical cleaning agents such as alcohol, acetone or diluents for cellulose lacquers.

LED (Light-Emitting Diode)















CAUTION! LED (light-emitting diode) HAZARD. Removing the protective covers and (when applicable) defeating the interlock(s) may result in exposure to the internal LED. LEDs can burn the retina, causing permanent blind spots. To ensure safe LED operation:

- Never look directly into the light beam.
- Wear proper eye protection and post a warning sign at the entrance to the laboratory if the LED protection is defeated for servicing
- Remove jewelry and other items that can reflect a light beam into your eyes or those of others

Do not remove safety labels, instrument protective panels, or defeat safety interlocks.

Explanation of symbols and warnings

The following table explains the symbols displayed on the instrument.

Symbol	Explanation
	The CE mark symbolizes that the product conforms to all applicable European Community provisions for which this marking is required.
	The E-Gel™ Power Snap Electrophoresis System complies with the Underwriters Laboratories Inc. regulation and is listed under file no. E189045 in the U.S. and Canada.
 Caution	Caution, risk of danger Consult the manual for further safety information.
	Caution, risk of electrical shock
	Do not stare into beam Turn off the lamp before opening Use eye protection during servicing
	Potential biohazard
	Protective conductor terminal (main ground)
	On
	Off
 WEEE	Do not dispose of this product in unsorted municipal waste CAUTION! To minimize negative environmental impact from disposal of electronic waste, do not dispose of electronic waste in unsorted municipal waste. Follow local municipal waste ordinances for proper disposal provision and contact customer service for information about responsible disposal options.
	The RCM symbol denotes that the device is compliant with the electromagnetic compatibility (EMC) of the Australian Communication and Media Authority (ACMA), Electrical Regulatory Authorities Council (ERAC), and Radio Spectrum Management (RSM).
	Consult instructions for use.
	Product catalog number.
	Site of manufacture.

Customer and technical support

Visit Thermo Fisher Scientific support for the latest in services and support, including:

- Worldwide contact telephone numbers
- Product support, including:
 - Product FAQs
 - Software, patches, and updates
- Order and web support
- Product documentation, including:
 - User guides, manuals, and protocols
 - Certificates of Analysis
 - Safety Data Sheets (SDSs; also known as MSDSs)

Note: For SDSs for reagents and chemicals from other manufacturers, contact the manufacturer.

Limited product warranty

Life Technologies Corporation and/or its affiliate(s) warrant their products as set forth in the Life Technologies' General Terms and Conditions of Sale found on Life Technologies' website at www.thermofisher.com/en/home/global/ If you have any questions, please contact Life Technologies at www.thermofisher.com/support.

For support visit [thermofisher.com/techresources](https://www.thermofisher.com/techresources) or email techsupport@lifetech.com

[thermofisher.com/lifescience](https://www.thermofisher.com/lifescience)

08 April 2020

ThermoFisher
S C I E N T I F I C