



Thermo Scientific™ CryoMed™ Controlled-Rate Freezer

Operating and Maintenance Instructions

331486H11 • Revision A • 10/20/2020

IMPORTANT Read this instruction manual. Failure to follow the instructions in this manual can result in damage to the unit, injury to operating personnel, and poor equipment performance.

CAUTION All internal adjustments and maintenance must be performed by qualified service personnel.

Material in this manual is for informational purposes only. The contents and the product it describes are subject to change without notice. Thermo Fisher Scientific makes no representations or warranties with respect to this manual. In no event shall Thermo Fisher Scientific be held liable for any damages, direct or incidental, arising from or related to the use of this manual.

© 2020 Thermo Fisher Scientific Inc. All rights reserved.

For your future reference and when contacting the factory, have the following information readily available. It can be found on the data plate attached to your unit.

Model Number: _____

Serial Number: _____

The following information, if available, is helpful for contacting the factory.

Date Purchased: _____

Purchase order number: _____

Source of Purchase: _____

(manufacturer or specific agent/rep organization)

Contents

Models.....	1
Safety Precautions	2
Handling Liquid Nitrogen	3
Unpacking	5
Packing List	5
Introduction	6
Intended Use.....	6
Control Panel	6
Door Latch	6
USB WiFi Dongle.....	6
Thermal Printer (Optional)	6
Operating Standards	7
Installation.....	8
Selecting a Location	8
LN2 Connections	9
Electrical Connections	9
Sample Thermocouple Connection	9
Start Up	10
Power-Up	10
Connectivity Requirements.....	10
Initial Start Up.....	11
Operation.....	16
Home Screen.....	16
Settings.....	17
Logs.....	23

Profiles	24
Users	28
Calibration	29
Active Run Summary	31
Initiate a Run	31
Manual Override	31
Stop a Profile Run	32
Run Review	32
Alarms	34
General Alarm Guidelines	34
Printer Set-Up	37
Change the Paper	37
Specifications	38
Temperature Uniformity	38
Parts List	40
Accessories	40
PC Interface Software	42
Installation	42
Login	44
Setup	46
Run Operation	46
Typical Run Procedure	49
Manual Override Procedure	50
End Run	51
Print	51
Alarms	52
Power Failure Recovery	53
Display/Control Summary	54

Edit Screen	54
Startup	54
Error Messages	58
Review Screen	60
User Controls	60
Options Screen	62
Plot Colors	62
Default Directories	63
Users	63
Status Bar	65
Help	66
About	66
Maintenance	67
Dry Gaskets and Heat Breaks	67
Disinfect Controlled-Rate Freezer Interior.....	67
Clean the Cabinet Exterior.....	68
Solenoid Valve Maintenance.....	68
Reset Heater Over temp Thermostat	68
Preventive Maintenance	68
Troubleshooting.....	70
Connectivity Troubleshooting	72
Appendix A: User Role Summary	74
Appendix B: City Time Zone.....	75
Warranty	82
Thermo Fisher Scientific PC and Peripheral Warranty	82
Thermo Fisher Scientific International Dealer PC and Peripherals Warranty	82

Thermo Fisher Scientific Controlled-Rate Freezer Warranty	82
Thermo Fisher Scientific International Controlled-Rate Freezer Dealer Warranty.....	83
WEEE Compliance	84
Regulatory	85
Product Safety	85
Conformity with European Regulations	85
21 CFR part 11	85
FCC Statement (USA)	85
Korea KC	86
Australi/New Zealand RCM	86
Contact Information	87

Models

The following table shows the different models covered in this Operating and Maintenance Manual.

Table 1. Applicable Models

Models	Chamber Volume	Electrical	Plug Type	Exterior Dimensions W x H x D in. (cm)	Interior Dimensions W x H x D in. (cm)	Printer Options
TSCM17XA		120V / 60Hz	NEMA 5-15P			
TSCM17XV	17L / 0.6 cu. ft.	220V / 50/60Hz	CEE 7/7	37.3 x 21.7 x 24.3 (94.7 x 55.1 x 61)	7 x 12 x 13 (17.8 x 30.5 x 33)	No Thermal Printer
TSCM17XL		100V / 60Hz	NEMA 5-15P			
TSCM34XA		120V / 60Hz	NEMA 5-15P			
TSCM34XV	34L / 1.2 cu. ft.	220V / 50/60Hz	CEE 7/7	43.3 x 21.7 x 24.3 (109.9 x 55.1 x 61)	13 x 12 x 13 (33 x 30.5 x 33)	No Thermal Printer
TSCM34XL		100V / 60Hz	NEMA 5-15P			
TSCM48XA		120V / 60Hz	NEMA 5-15P			
TSCM48XV	48L / 1.7 cu. ft.	220V / 50/60Hz	CEE 7/7	49.3 x 21.7 x 24.1 (125.2 x 55.1 x 61)	19 x 12 x 13 (48.3 x 30.5 x 33)	No Thermal Printer
TSCM48XL		100V / 60Hz	NEMA 5-15P			
TSCM17PA		120V / 60Hz	NEMA 5-15P			
TSCM17PV	17L / 0.6 cu. ft.	220V / 50/60Hz	CEE 7/7	37.3 x 21.7 x 24.3 (94.7 x 55.1 x 61)	7 x 12 x 13 (17.8 x 30.5 x 33)	Built-in Thermal Printer
TSCM17PL		100V / 60Hz	NEMA 5-15P			
TSCM34PA		120V / 60Hz	NEMA 5-15P			
TSCM34PV	34L / 1.2 cu. ft.	220V / 50/60Hz	CEE 7/7	43.3 x 21.7 x 24.3 (109.9 x 55.1 x 61)	13 x 12 x 13 (33 x 30.5 x 33)	Built-in Thermal Printer
TSCM34PL		100V / 60Hz	NEMA 5-15P			
TSCM48PA		120V / 60Hz	NEMA 5-15P			
TSCM48PV	48L / 1.7 cu. ft.	220V / 50/60Hz	CEE 7/7	49.3 x 21.7 x 24.3 (125.2 x 55.1 x 61)	19 x 12 x 13 (48.3 x 30.5 x 33)	Built-in Thermal Printer
TSCM48PL		100V / 60Hz	NEMA 5-15P			

Safety Precautions

In this manual, the following symbols and conventions are used.



WARNING: This symbol when used alone indicates important operating instructions which reduce the risk of injury or poor performance of the unit.



WARNING: This symbol indicates potentially hazardous situations which, if not avoided, could result in serious injury or death.



WARNING: This symbol indicates situations where dangerous voltages exist and potential for electrical shock is present.



CAUTION: This symbol, in the context of a CAUTION, indicates a potentially hazardous situation which if not avoided could result in minor to moderate injury or damage to the equipment. This indicates a situation which may result in property damage.



CAUTION: Equipment being maintained or serviced must be turned off or locked off to prevent possible injury.



WARNING: Before installing, using or maintaining this product, be sure to read the manual and product warning labels carefully. Failure to follow these instructions may cause the product to malfunction, which could result in injury or damage.



CAUTION: Contains Parts and Assemblies Susceptible to Damage by Electrostatic Discharge (ESD)



WARNING: The snowflake symbol indicates low temperatures and risk of frost bite. Do not touch bare metal or samples with unprotected body parts.



WARNING: Potential asphyxiation hazard. This equipment should be located in a well ventilated room.



WARNING: This symbol indicates a need to use gloves during the indicated procedures. If performing decontamination procedures, use chemically resistant gloves. Use insulated gloves for handling samples and when using liquid nitrogen.



WARNING: Unit weighs more than 50 lbs (22.7 kg). Use proper 2 person lifting techniques when handling.



CAUTION: This symbol indicates surfaces which may become hot during use and may cause a burn if touched with unprotected body parts.



WARNING: This symbol indicates potentially hazardous situations, which if not avoided could result in fire.



WARNING: Potential biological hazards. Proper protective equipment and procedures must be used.



WARNING: Whenever working with liquid nitrogen storage equipment in a closed environment, use of personal O₂ detection equipment is strongly recommended.



WARNING: Ultra low temperatures are associated with this equipment. Instructions in this section should only be carried out when using special handling equipment or when wearing special handling protective clothing.



WARNING: Extreme temperature hazards. Only qualified persons should perform procedures associated with this symbol.

Note

Because argon is not an inert gas whose physical properties are very similar to those of nitrogen, the precautions and safe practices for the handling and use of liquid argon are the same as those for liquid nitrogen.



WARNING: The unit is equipped with six self-leveling legs. Install the unit on the counter top, ensuring all 6 legs are in contact with the counter. When the unit door is open, do not lean against or put weight on top of the open door, as doing so may cause the unit to tip.



WARNING: All internal adjustments and maintenance must be performed by qualified service personal.

Handling Liquid Nitrogen



WARNING: Contact of liquid nitrogen or cold gas with the skin or eyes may cause serious freezing (frostbite) injury.

Handle liquid nitrogen carefully.

The extremely low temperatures can freeze human flesh very rapidly. When spilled on a surface, the liquid tends to cover it completely, cooling a large area. The gas issuing from the liquid is also extremely cold. Delicate tissue, such as that of the eyes, can be damaged by exposure to cold gas which would be too brief to affect the skin of the hands or face.

Never allow any unprotected part of your body to touch objects cooled by liquid nitrogen.

Note: Always wear gloves when handling anything that is, or may have been, in immediate contact with liquid nitrogen. Insulated gloves are recommended, but heavy leather gloves may also be used. The gloves should fit loosely, so that they can be thrown off quickly if liquid should splash into them.

Such objects may stick rapidly to the skin and tear the flesh when you attempt to free yourself. Use tongs to withdraw objects immersed in the liquid, and handle the object carefully.

Wear protective clothing.

Protect your eyes with a face shield or safety goggles (safety glasses without side shields do not give adequate protection). When handling liquid in open containers, it is advisable to wear high-top shoes. Trousers (which should be cuff less if possible) should be worn outside the shoes.

Introduction

The safe handling and use of liquid nitrogen in cryogenic freezer and dewar flasks is largely a matter of knowing the potential hazards and using common-sense procedures based on that knowledge. There are two important properties of liquid nitrogen that present potential hazards:

1. It is extremely cold. At atmospheric pressure, liquid nitrogen boils at -320°F (-196°C).
2. Very small amounts of liquid vaporize into large amounts of gas. One liter of liquid nitrogen becomes 24.6 cu. ft. (0.7 m^3) of gas.

The safety precautions in this manual must be followed to avoid potential injury or damage which could result from these two characteristics. Do not attempt to handle liquid nitrogen until you read and fully understand the potential hazards, their consequences, and the related safety precautions. Keep this information handy for ready reference and review.

Note: Because argon is an inert gas whose physical properties are very similar to those of nitrogen, the precautions and safe practices for handling and use of liquid argon are the same as those for liquid nitrogen.

Use containers designed for low temperature liquids.

Cryogenic containers are specifically designed and made of materials that can withstand the rapid changes and extreme temperature differences encountered in working with liquid nitrogen. Even these special containers should be filled SLOWLY to minimize the internal stresses that occur when any material is cooled. Excessive internal stresses can damage the container.

Do not cover or plug the entrance opening of any liquid nitrogen freezer or dewar.

Do not use any stopper or other device that would interfere with venting of gas. These cryogenic liquid containers are generally designed to operate with little or no internal pressure. Inadequate venting can result in excessive gas pressure which could damage or burst the container. Check the unit periodically to be sure that venting is not restricted by accumulated ice or frost.

Use proper transfer equipment.

Use a phase separator or special filling funnel to prevent splashing and spilling when transferring liquid nitrogen into or from a dewar. The top of the funnel should be partly covered to reduce splashing. Use only small, easily-handled dewars for pouring liquid. For the larger, heavier containers, use a cryogenic liquid withdrawal device to transfer liquid from one container to another. Be sure to follow instructions supplied with the withdrawal device. When liquid cylinders or other large storage containers are used for filling, follow the instructions supplied with those units and their accessories.

Do not overfill containers.

Filling above the bottom of the neck-tube (or specified maximum level) can result in overflow and spillage of liquid when the neck-tube core or cover is placed in the opening.

Never use hollow rods or tubes as dipsticks.

When a warm tube is inserted into liquid nitrogen, liquid will spout from the top of the tube due to gasification and rapid expansion of liquid inside the tube.



WARNING: Nitrogen gas can cause suffocation without warning. Store and use liquid nitrogen only in a well-ventilated place.

As the liquid evaporates, the resulting gas tends to displace normal air from the area. In closed areas, excessive amounts of nitrogen gas reduce the concentration of oxygen and can result in asphyxiation. Because nitrogen gas is colorless, odorless and tasteless, it cannot be detected by the human senses and will be breathed as if it were air. Breathing an atmosphere that contains less than 18% (or) 20% oxygen can cause dizziness and quickly result in unconsciousness and

death. Use of oxygen monitoring equipment is strongly recommended.

Note: The cloudy vapor that appears when liquid nitrogen is exposed to the air is condensed moisture; not the gas itself. The issuing gas is invisible.

Never dispose of liquid nitrogen in confined areas or places where others may enter. Disposal of liquid nitrogen should be done outdoors in a safe place. Pour the liquid slowly on gravel or bare earth where it can evaporate without causing damage. Do not pour the liquid on pavement.

First Aid

If a person seems to become dizzy or loses consciousness while working with liquid nitrogen, move to a well-ventilated area immediately. If breathing has stopped, apply artificial respiration. If breathing is difficult, give oxygen. Call a physician. Keep warm and at rest.

If exposed to liquid or cold gas, restore tissue to normal body temperature (98.6°F) as rapidly as possible, followed by protection of the injured tissue from further damage and infection.

Remove or loosen clothing that may constrict blood circulation to the frozen area. Call a physician. Rapid warming of the affected part is best achieved by using water at 108°F. Under no circumstance should the water be over 112°F, nor should the frozen part be rubbed either before or after rewarming.

Unpacking

At delivery, examine the exterior for physical damage while the carrier's representative is present. If exterior damage is present, carefully unpack and inspect the unit and all accessories for damage.

If there is no exterior damage, unpack and inspect the equipment within 15 days of delivery. If you find any damage, keep the packing materials and immediately report the damage to the carrier.

Do not return goods to the manufacturer without written authorization.

When submitting a claim for shipping damage, request that the carrier inspect the shipping container and equipment.

Packing List

The following items are packed along with the unit:

- USB that contains:
 - Installation and Operation manual.
 - PC Interface 3.3
- Essential Safety Instructions
- 2 ML Int Sample T/C Probe
- 9 Pin DB9 10 ft. Ext Cable
- Standard Ampules Stopper
- Straw Stopper
- 6 Ft LN₂ Transfer Hose SS
- USB to Serial Adapter
- USB WiFi Dongle
- DPU-S445 User's Guide Disk (Optional)- accessible with thermal printer models

Remove the Shipping Brackets



CAUTION: Use proper 2-person lifting techniques when handling the unit (refer **Table 2** for approximate unit weight).



CAUTION: Do not rest the unit on its back as it may damage the plumbing or plastic heat break.



WARNING: Carefully remove the shipping brackets. Some edges may be sharp.

Using a 7/16" wrench or socket, remove the (4) lag screws attached to the shipping pallet. Remove the (4) 1/4-20 bolts to detach the (2) shipping brackets from the bottom of the unit. Refer to the **Figure 1** below.

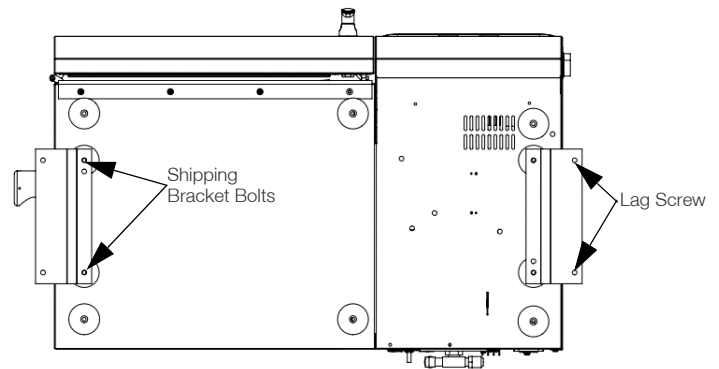

Figure 1. Bottom view of the unit

Table 2. Unit weights

Model	lbs. (kg)	Model	lbs. (kg)
TSCM17PA	155 (70.3)	TSCM17XA	154 (69.8)
TSCM17PV	155 (70.3)	TSCM17XV	154 (69.8)
TSCM17PL	155 (70.3)	TSCM17XL	154 (69.8)
TSCM34PA	175 (79.3)	TSCM34XA	174 (78.9)
TSCM34PV	175 (79.3)	TSCM34XV	174 (78.9)
TSCM34PL	175 (79.3)	TSCM34XL	174 (78.9)
TSCM48PA	192 (87.0)	TSCM48XA	191 (86.6)
TSCM48PV	192 (87.0)	TSCM48XV	191 (86.6)
TSCM48PL	192 (87.0)	TSCM48XL	191 (86.6)

Note: These are the unpackaged weights of the unit.

Introduction

Intended Use

Thermo Scientific CryoMed Controlled-Rate Freezers are sample preparation devices used for the preparation of samples for storage at ultra-low or cryogenic temperatures (-80°C to -196°C).

The Controlled-Rate Freezers are intended for use:

- As a sample preparation device in research use.
- For preparation of samples not intended to be re-introduced into the human body such as primary cell lines or stem cells for research.

Non-Intended Use

These CryoMed Controlled-Rate Freezers are not intended to be operated in potentially explosive environments and are not intended for storage of flammable inventory. It is not considered as a medical device and has not been registered with a medical device regulatory body (e.g. FDA); i.e, it has not been evaluated for the storage of samples for diagnostic use or for samples to be reintroduced to the body.

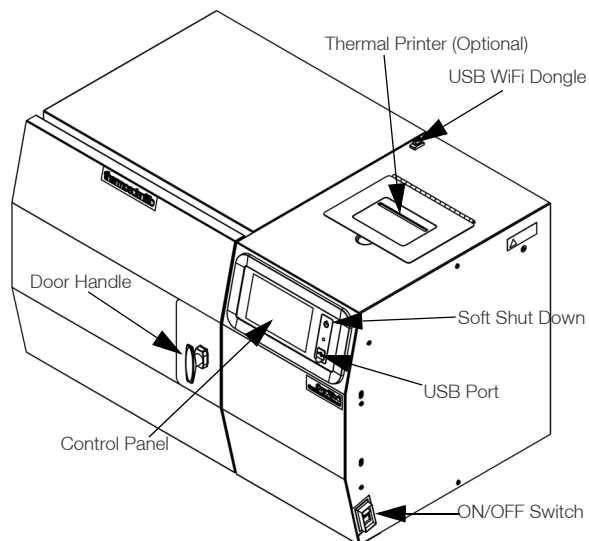

Figure 2. CryoMed Controlled-Rate Freezer

ON/OFF

The right side of the unit is equipped with an ON/OFF switch as shown in **Figure 2**.

- I Power ON switch
- 0 Power OFF switch

Control Panel

A 7" touch screen user interface is provided at front of the unit as shown in **Figure 2** to control the unit.

Door Latch

The door of the Controlled-Rate Freezer is secured in the closed position with a vise-action T-handle latch as shown in **Figure 2**. The latch maintains positive compression of the door gasket against the Teflon heat break to prevent leakage and ice build-up during normal operation. The latch is closed by turning the handle 180° clockwise.

Make sure that the door is latched properly during operation to prevent ice build-up.

USB WiFi Dongle

A USB WiFi dongle will be shipped with the unit, which allows you to connect to a user accessible WiFi network (WPA2, Enterprise) and establish a connection to Thermo Connect. Check **Connectivity Requirements** for more details.

Thermal Printer (Optional)

There is a printer on top of the CryoMed Controlled-Rate Freezer as shown in **Figure 2**. Printer provides a visual record of a profile run, including any errors/alarms which might have occurred. Run data is captured upon run completion, which can then be printed from the Run Review screen.

Operating Standards

These units are designed to operate under the following environmental conditions:

- Indoor use
- Altitude up to 2000 m
- Ambient temperature: 15°C to 35°C
- Humidity: 20%~85%, non-condensing
- Mains Supply Fluctuations: $\pm 5\%$ of nominal for better performance
- Installation Category II
- Pollution Degree 2
- Class of Equipment I

Installation



WARNING: Nitrogen gas can cause suffocation without warning. Store and use liquid nitrogen only in a well-ventilated place. As the liquid evaporates, the resulting gas displaces the normal air in the area. (The cloudy vapor that appears when liquid nitrogen is exposed to the air is condensed moisture, not the gas itself. The issuing gas is invisible.) In closed areas, excessive amounts of nitrogen gas reduces the concentration of oxygen and can result in asphyxiation. Because nitrogen gas is colorless, odorless, and tasteless, it cannot be detected by the human senses. Breathing an atmosphere that contains less than 19.5% (or) 20% oxygen can cause dizziness and quickly result in unconsciousness and death. Therefore, the use of oxygen monitoring equipment is strongly recommended.



WARNING: Contact of liquid nitrogen with the skin or eyes may cause serious (freezing) injury.



CAUTION: Use proper 2-person lifting techniques when handling the unit (refer to Specifications section for approximate unit weight).

Selecting a Location

A six foot liquid nitrogen transfer hose with 1/2" flare fittings is supplied with the unit. The use of a transfer hose longer than six feet may degrade system performance as it may prevent liquid nitrogen from reaching the unit in the volume needed to properly control the temperature profile run.

The unit should be located within the reach of the transfer hose to the liquid nitrogen supply, allowing enough space for source tank replacement. A gauge to measure the remaining contents in the source tank should be easily viewable and read before each run to ensure that enough liquid nitrogen is available for successful temperature profile completion. A dedicated source tank is recommended for optimum performance.

Unit should be located in a well-ventilated area of the laboratory. Place the unit on a table/bench which is capable of supporting the unit's weight (see **Table 2**), with adequate workspace available. Allow clearance for the door on the front of the unit, for the hose and power connections on the back

and the exhaust vent on the left side of the unit. Refer to **Figure 3** for rear side connections.



WARNING: Do not block nor tamper with the exhaust vent opening! Provide ample clearance around the exhaust vent to allow the gases to escape freely, otherwise an increase of gas pressure inside the chamber will forcibly open the door possibly causing damage to the unit and risking sample integrity.

Behind the electronics housing is a 1/4" OD overflow drain tube from the drain pan placed under the inlet solenoids. Although most of the frost will melt and evaporate within the drain pan, it is possible that a small amount of water may drip out of the drain tube.



CAUTION: If moisture cloud is seen exiting the drain tube, turn off the unit, shut off the liquid nitrogen supply source valve, and immediately call for service.

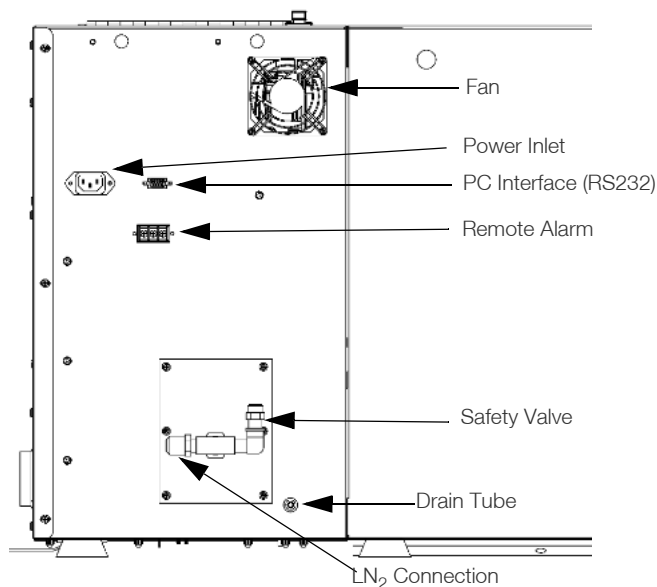

Figure 3. Rear view of the unit

LN₂ Connections



CAUTION: The flair connections on the ends of the transfer hose do not require any sealant. Pipe dope or Teflon[®] tape may cause contamination of the liquid fill solenoids or leaks at the hose connections because these cannot withstand the extreme low temperatures of this application.

The unit requires a user-supplied, clean, low pressure regulated (22 PSIG \pm 30%) liquid nitrogen supply. Pressure higher than recommendations may degrade unit performance as these could hold the fill solenoids partially open. A 60 PSIG liquid nitrogen pressure relief valve is located on the back of the unit (**Figure 3**).



CAUTION: Do not disable or remove the pressure relief valve.

Connect the transfer hose between the low pressure, liquid outlet of the nitrogen supply tank (not the gas outlet) and the LN₂ supply inlet located on the back of the unit **Figure 3**. The unit is shipped with a removable plastic protective cap over the LN₂ supply inlet to keep debris out of the solenoids and protect the inlet threads during shipping and handling. Do not over-tighten the fitting as it may damage the internal plumbing. Arrangements should be made to collect the water which will form on the transfer hose from melted frost, to prevent a potential slip or fall hazard.

After the transfer hose has been connected, open the supply valve and check the connections for leaks.

Electrical Connections

See the serial tag on the side of the unit for electrical specifications.

1. Verify the ON/OFF switch on the right side of the unit is OFF.
2. Connect the appropriate line cord to the power inlet on the rear of the unit.
3. Connect the unit to a grounded, dedicated circuit.



CAUTION: The ON/OFF switch is the main disconnect device for the unit. Position the unit so the switch is easily accessible.

Sample Thermocouple Connection

1. Open the unit door.
2. Locate the thermocouple connector in the front upper right corner of the chamber.
3. Install the supplied sample thermocouple in the correct orientation.
4. Close the unit door.

Note: The freezer has been calibrated at the factory with the 1.2/2.0 ml sample thermocouple probe installed in the internal thermocouple connector. Refer **Calibration** section to calibrate an external thermocouple probe.



Figure 4. Sample Thermocouple Connection

Start Up

Power-Up

1. Turn on the Controlled-Rate Freezer power switch on the right side of the unit.
2. The startup screen will be displayed.
3. Wait for the Start Setup button to appear.

Note: The LED to the right of the UI should be green.

Connectivity Requirements

There are two requirements to take full advantage of your Controlled-Rate Freezer connectivity options:

1. The Controlled-Rate Freezer can be connected to the internet, using wireless connection only.
 - a. Refer to **WiFi Specification table** for acceptable network security parameters.
 - b. Speak with your local Information Technology (IT) group about the correct wireless network and password to use.
2. You must have a Thermo Fisher Connect account to link the unit to his/her account via InstrumentConnect™. To create a Thermo Fisher Connect account:
 - a. Use a web browser to open the following URL:
https://apps.thermofisher.com
 - b. Choose “Create an Account” and follow the instructions to establish a new account. (Remember your login information for later use.)
 - c. (Optional) Download the InstrumentConnect mobile/tablet application from the AppStore or PlayStore.

Note: InstrumentConnect™ allows you to monitor all connected instruments. To access this section, click on the InstrumentConnect icon indicated below.

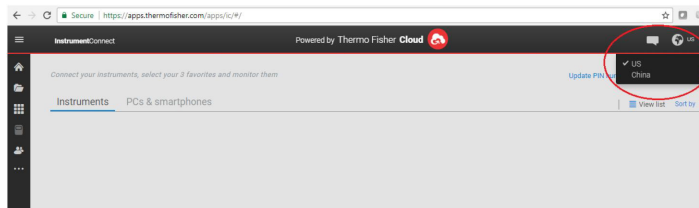
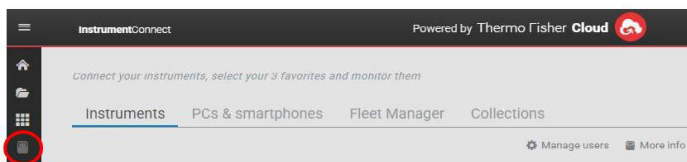

Figure 5. InstrumentConnect Screen

Note: Users outside U.S.A, Canada and Europe cannot access Connectivity with Wifi Dongle.

Table 3. WiFi Specification table

Parameter	Specification
Default WiFi transmission frequency to the cloud	Once after every profile run for run file transmission.
WiFi protocol	2.4 GHZ only IEEE 802.11b/g/n
WiFi Security	WPA2PSK WPA2PEAP(PEAP)
WiFi Data Rate	Minimum of 1 Mbps
WiFi Range	Up to 30 meters
Minimum Required Wireless Signal	-67 dbM
Firewall Ports that must open	123, 443

Note: Thermo Fisher Scientific connected devices support certification validation.

If your Controlled-Rate Freezer is unable to connect to either a wireless network or a cloud account, verify your name and password, and re-connect.

If issues persist, contact our local support.

Note: If your network password expires or changes, your Controlled-Rate Freezer will no longer connect automatically. Be sure to manually update your password in the Controlled-Rate Freezer user interface settings to reconnect. Failure to reconnect prior to completing a profile run will result in data loss.

Initial Start Up

To start up the Controlled-Rate Freezer, complete the following steps:

- Once the Controlled-Rate Freezer is powered up, the Thermo Scientific logo is displayed on the front screen. If this is the first time the unit is being turned on, an initial setup must be completed. Press the **Start Setup** button to initiate the setup.



Figure 6. Main Screen

The first step of the setup is to select the language. This screen allows you to specify the preferred display language. Once the language is selected, press the **Next** button.

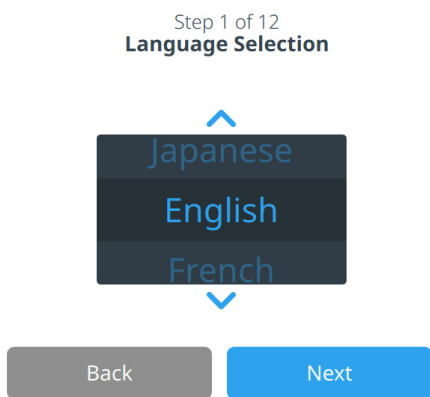

Figure 7. Language Selection Screen

The next screen allows you to select your location. Enter the name of the country and the city and select from the list of suggestions displayed.

After selecting the region, press the **Next** button.

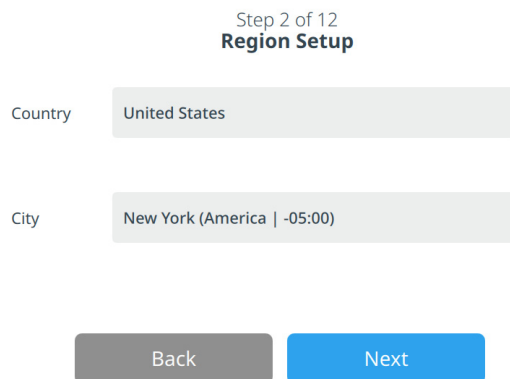

Figure 8. Region Setup Screen

When entering your “City” into the Region Setup screen, refer to “**Appendix B: City Time Zone**”. Follow the table to select the city closest to your time zone. The next screen allows you to identify an individual Controlled-Rate Freezer by specifying a Unit Name. After entering a name, press the **Next** button.

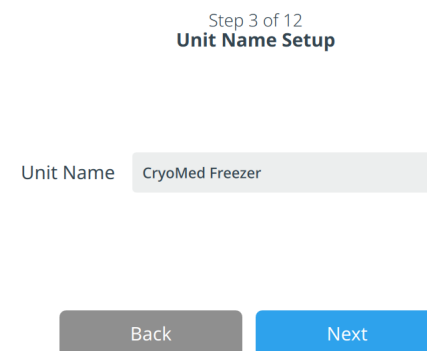

Figure 9. Unit Name Setup Screen

The next few screens allow you to setup a wireless connection to store information on InstrumentConnect.

To fully connect your new unit, you will need to:

1. Connect the unit to a wireless network allowing data to be sent to Thermo Fisher Connect.
2. Log in to Thermo Fisher Connect (web or app) and link the unit to your account via InstrumentConnect.

Note: Before you begin, establish a Thermo Fisher Connect account and have your network login information available. Refer to **Power-Up** section for details.

Accept the terms and conditions for using connectivity on this device.

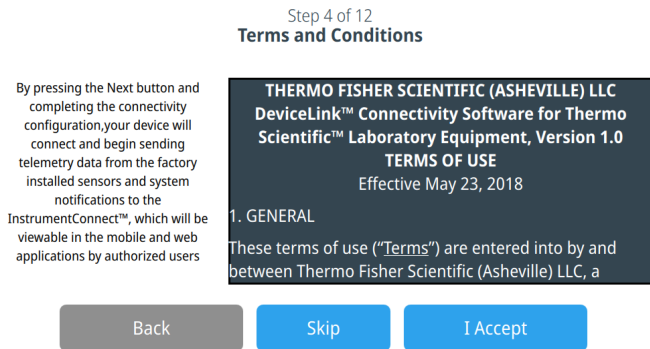

Figure 10. Terms and conditions screen

If you chose to **Skip** this acceptance, WiFi connectivity will be disabled. You will be able to accept the terms and enable connectivity at a later time via the Connectivity settings menu.

If you skip the acceptance you will be navigated to the Date Setup screen.

Select the preferred date format. Once the date is selected (highlighted), press the **Next** button.

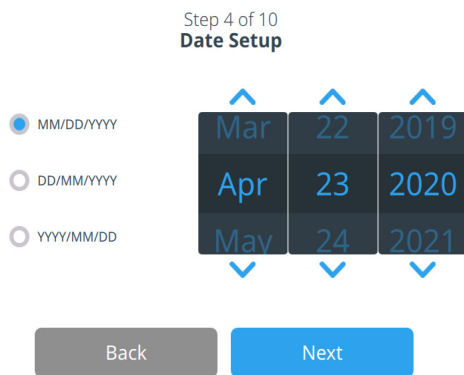

Figure 11. Date Setup Screen

The next screen allows you to setup the Time.

Select the preferred time format. Once the intended time is selected (highlighted), press the **Next** button.

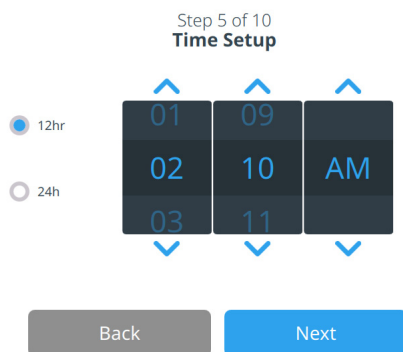

Figure 12. Time Setup Screen

If you accept the terms and conditions of using connectivity on this device you will be navigated to Wireless Setup.

Select a wireless network and press the **Next** button.

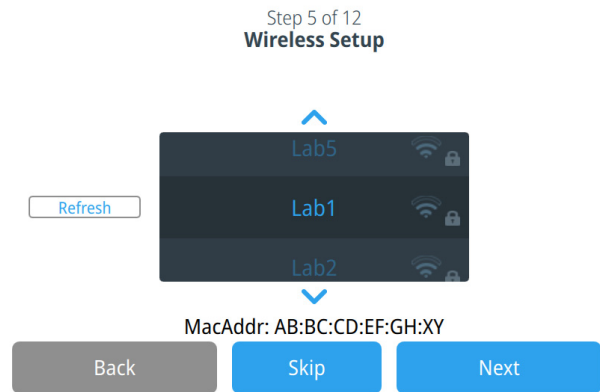

Figure 13. Wireless Setup Screen

Once the intended network is selected (highlighted), you must press the **Next** button.

The following instructions are for WPA2 connection type.

Enter the network password and press the **Next**.

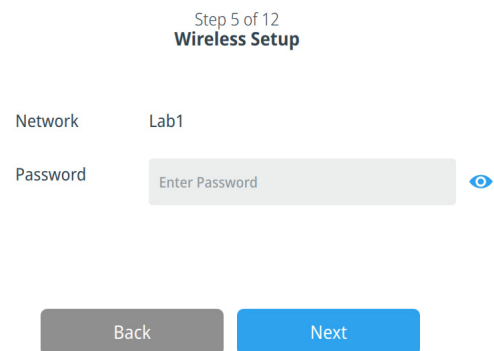



Figure 14. Wireless Setup (Password) Screen

Note: Press the eye icon  on the screen for password visibility

A success message is displayed once the connection is established. If the connection fails, a general error message is displayed. It could be due to an incorrect WiFi password or network incompatibility. After 5 seconds, the interface will return to the previous screen.

If this occurs, check the network status and re-enter the correct password to establish the connection. (Tip: Use the eye icon to verify the password entry before attempting connection.)

Refer to the **Connectivity Troubleshooting** section for more connectivity issues.

Step 6 of 12
Network Configuration

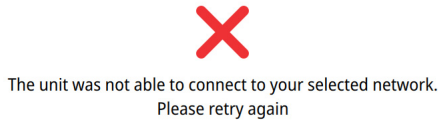

Figure 15. Wireless Setup Error Message Screen

The Network Configuration screen appears after a successful connection is established, which displays the time and date based on the wireless network. Verify the information displayed and press **Next**.

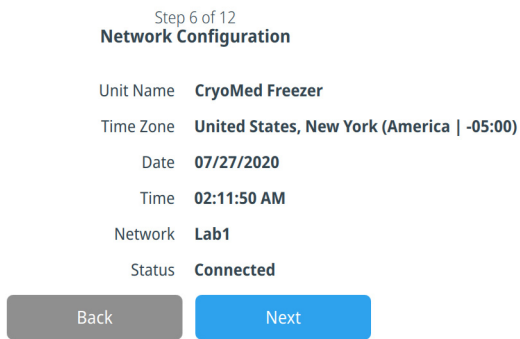

Figure 16. Network Configuration Screen

The next screen displays three options to connect your unit to InstrumentConnect. You can store historical data and receive alarm notifications to your InstrumentConnect account.

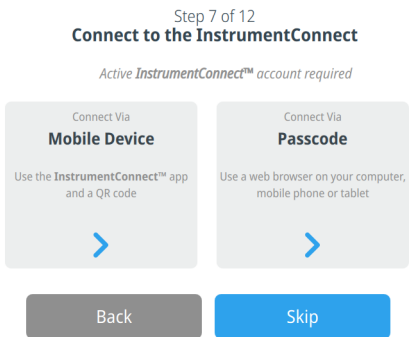

Figure 17. Connect to the InstrumentConnect Screen

Connect via Mobile Device

Selecting the Connect via Mobile Device option displays the following screen. Follow the instructions to connect to InstrumentConnect.

Step 7 of 12
Connect to the InstrumentConnect

- 1 Launch the **InstrumentConnect™** mobile app
Available from Apple Store and Google Play
- 2 Within the app, tap the + icon and select the QR code option
- 3 Scan the QR code to connect the unit
Connection times vary depending upon network speeds.



(expires in 04:39)

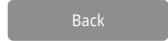

Figure 18. Connect to the InstrumentConnect (via Mobile Device) Screen

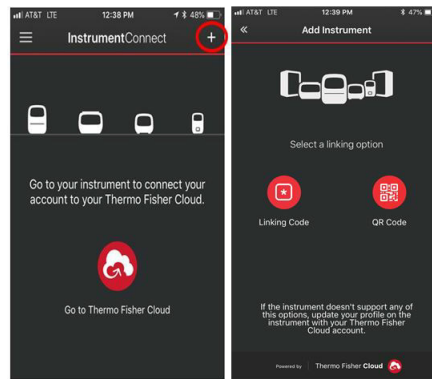

Figure 19. InstrumentConnect Mobile Device Screens

Connect via Pass code

This option displays a code that must be entered to connect to InstrumentConnect.

Step 7 of 12
Connect to the InstrumentConnect

1. Sign in to InstrumentConnect via <https://apps.thermofisher.com>
2. Go to Instrument Page
3. Add an instrument with code provided

A0C1X5
(expires in 04:45)

This page closes once the code is accepted.

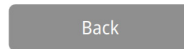

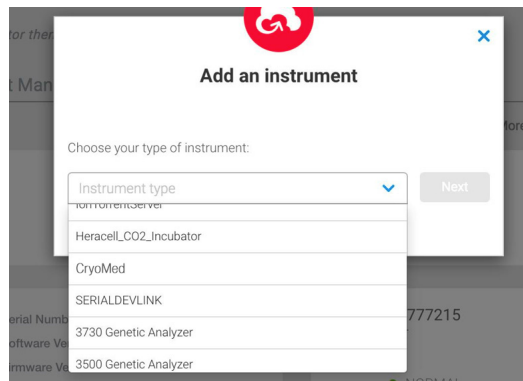
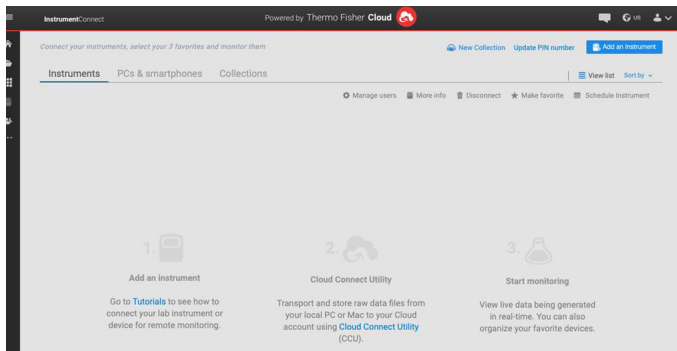

Figure 20. Connect to the InstrumentConnect (via Pass code) Screen

The following screens provide installation instructions.

The first screen provides information about selection of location where the unit should be placed. Press **Next** after reviewing.

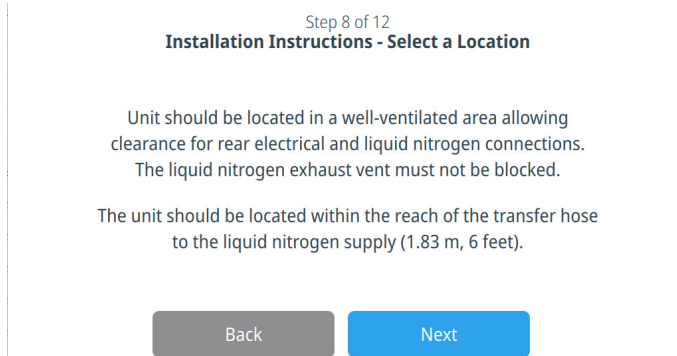

Figure 21. Installation Instructions (Select a Location) Screen

The second screen provides information regarding LN₂ Connections. Press the **Next** button after reviewing.



**Step 9 of 12
Installation Instructions - LN2 Connections**

The unit requires a user supplied, clean, low pressure regulated (22 PSIG +/- 30%) liquid nitrogen supply.

Pressure higher than recommendations may degrade unit performance by holding the solenoids partially open.



Figure 22. Installation Instructions (LN2 Connections) Screen

The third screen provides information regarding Other Setup and Calibration. Press the **Next** button after reviewing.

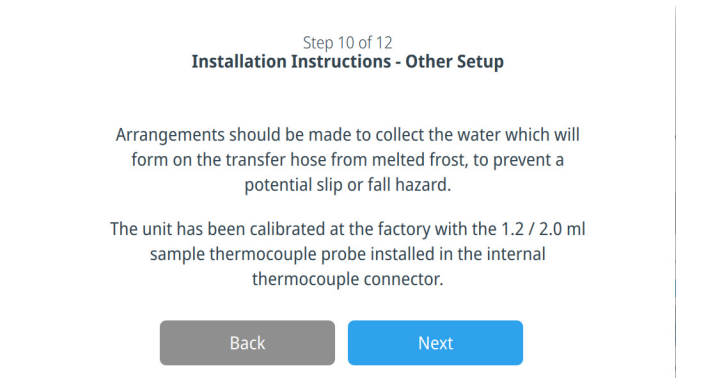
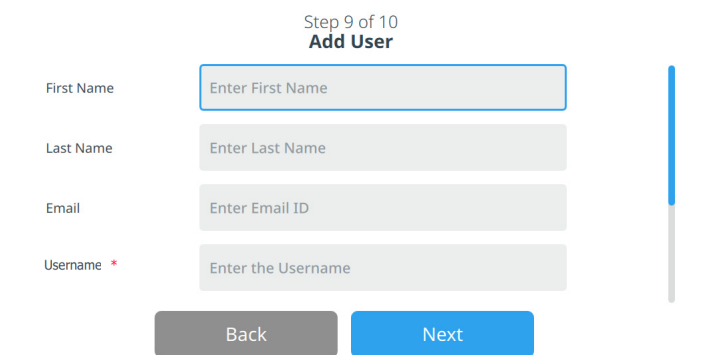

Figure 23. Installation Instructions (Other Setup) Screen

In the Add User Screen, you can add a user by entering the user's First Name, Last Name, Email, User Name, Password and User Role. User name, password and User Role are required. After entering all the details press **Next**.



Step 9 of 10
Add User

Username *

Password *

Confirm Password *

User Role *

Figure 24. Add User Screen

This screen indicates your initial setup is complete. Press the **Finish** button to complete initial setup or the Back button to make changes.

Step 10 of 10
Complete Setup

Setup is complete.

Please tap the finish button to begin using the equipment.

Figure 25. Complete Setup Screen

Operation

Home Screen







There are 4 key elements of Home Screen on the Controlled-Rate Freezer as shown in **Figure 26**:

1. The vertical pane on the left is the navigation bar that provides access to all functions of the unit.
2. The horizontal pane on the top will display the name of the unit, date, time, operational mode, connectivity detail, alarm indicator and the Login Button.
3. The horizontal pane in the middle will display the Chamber and Sample temperatures and previous run detail.
4. The horizontal pane at the bottom contains the Run Last button, Warming Mode button and the Onboard Help button.

The Home Screen below is the default screen.



Figure 26. Home Screen

-  **Back:** Allows you to return to the prior screen.
-  **Home:** Press to view the home screen.
-  **Settings:** Provides a list of settings grouped by usage frequency.
-  **Logs:** Press to view and export run and event logs.
-  **Profiles:** Press to view, modify, create or run profile.
-  **Users:** Press to view, modify or create users.



Calibration: Press to view current calibration information or to perform a calibration

Login

Login is required to perform any function on the unit. Auto logout will occur after 5 minutes of inactivity on the user interface.



Prior Run Review

Prior Run Review is a convenience feature that will navigate the user to the Run Review screen for the most recently completed run.

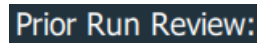

Run Last

Run Last is a convenience feature that will navigate the user to the Run Information screen before allowing the user to start another run with the same profile of recently completed run.

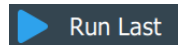

Warming Mode

Used to quickly warm up the chamber to 25°C and prepare for the next run.



After the chamber temperature reaches 25°C for 5 minutes the unit will buzzer for 10 seconds and hold the temperature for an additional 25 minutes.

Manually terminate warming mode by pressing the Warming mode icon again.

Note: When warming mode is active you cannot navigate away from the home screen.

Note: Door may be opened during warming mode to improve warming rate.

Onboard Help



The on board help button will display an on board help box with text explaining all of the features available on that particular screen.

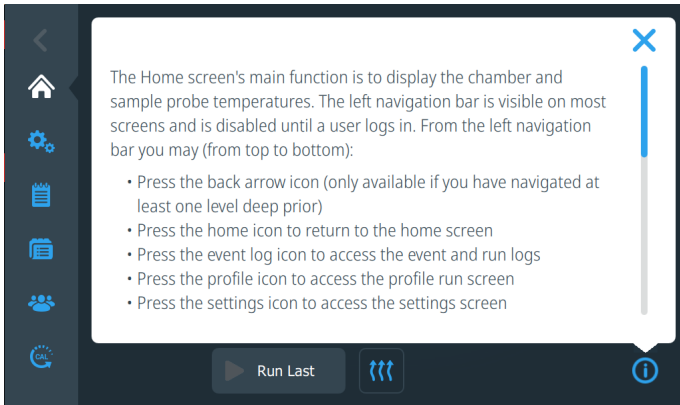

Figure 27. Onboard Help Screen

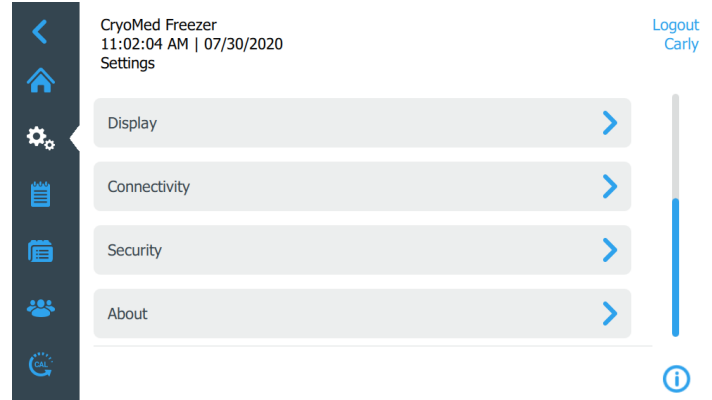

Figure 29. Settings Screen

Indicators

At the top left of the control panel the operating mode is indicated using below indicators:

- Idle** No profile is running
- Running** A profile is in progress
- Warming** Chamber is warming to +25°C

When a profile is running, the active step will also be displayed (Running: Preset_1, step 1).

Settings

The second tab on the navigation bar is the Settings tab. The following screen is displayed when the Settings tab is selected:

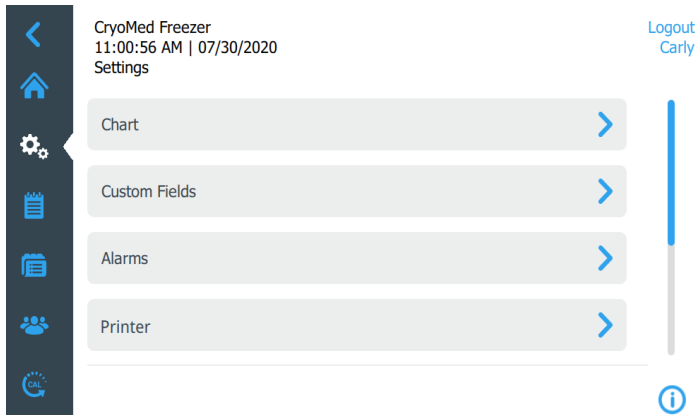

Figure 28. Settings Screen.

Note: Users with Admin privileges can access all the settings, whereas other Users can access only the Printer, Display and About options.

Chart

Pressing the Chart button will navigate a user to the following screen:

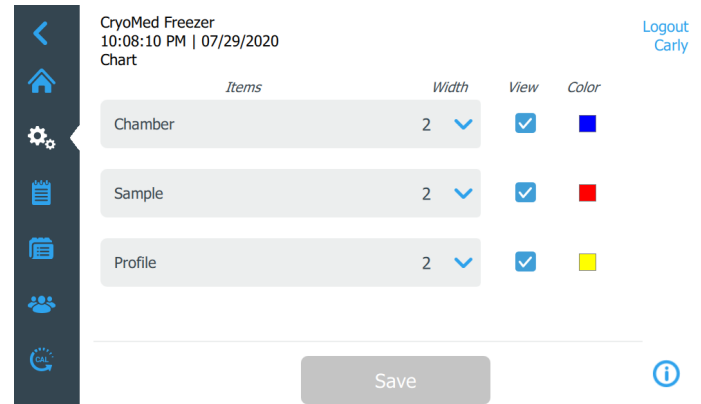

Figure 30. Settings (Chart) Screen

Here the visibility, color and width of the chamber, sample and profile series can be adjusted. You can select the width of the series from the drop down between 2 to 5, with 2 being the lowest and 5 being the highest width dimension.

If you want to change the color of the lines press on the color box of the specific series.

A color palette will be displayed as shown below. Select the desired color for that specific item.

Note: Select different colors for different item series.

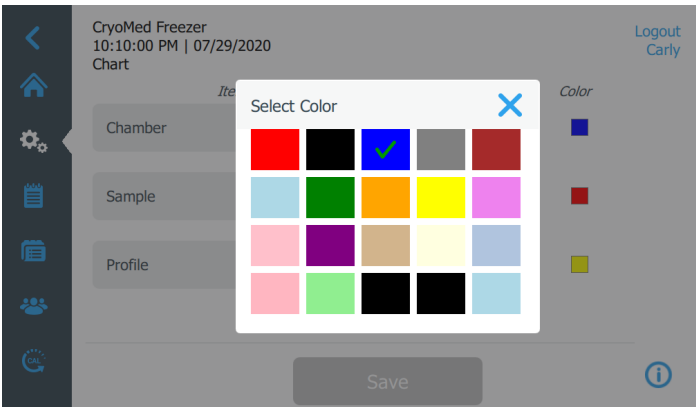

Figure 31. Chart color pallet Screen

Chart settings are applied to both Active Run and Run Review Charts.

Select Save to apply changes.

Custom Fields

When you select Custom Fields, the following screen is displayed:

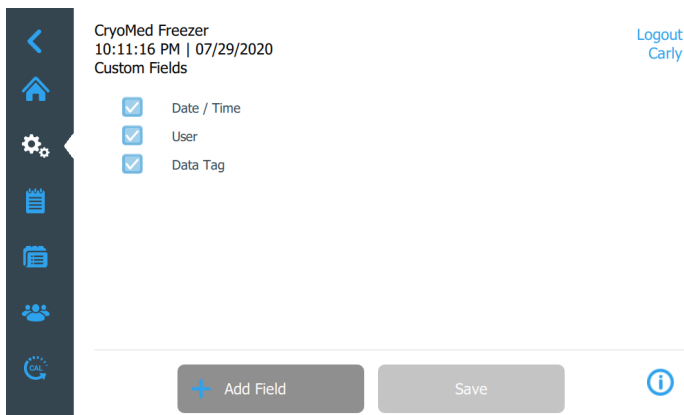

Figure 32. Settings (Custom Fields) Screen

Press on Add Field button to enter more custom fields (refer **Figure 33**). You can add up to 12 custom fields. Custom Fields are used to provide additional metadata or details about a profile.

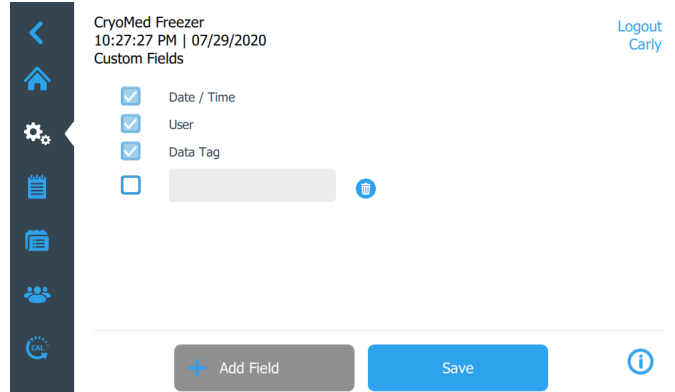

Figure 33. Settings (Add Custom Field) Screen

Alarms

When you select Alarms, the following screen is displayed:

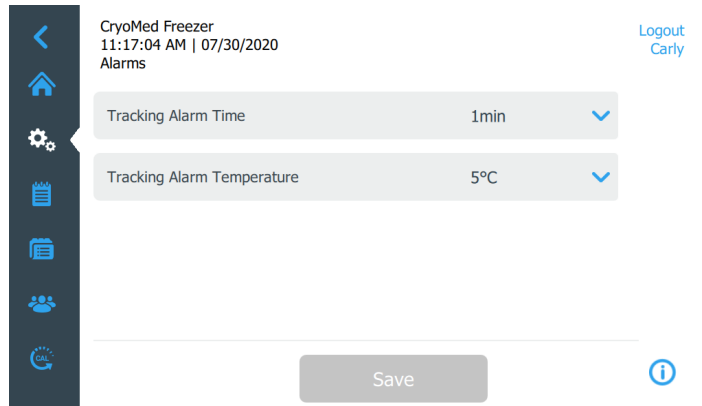

Figure 34. Settings (Alarms) Screen

Here you can adjust the following parameters for the Tracking Alarm and Temperature:

- **Tracking Alarm Time:** From 1, 3, 5, 10 minutes using the drop down menu.
- **Tracking Alarm Temperature:** From 3°C, 5°C, 10°C, 15°C using the drop down menu.

Select Save button to apply all changes.

Printer (Optional)

When you select Printer, the following screen is displayed:

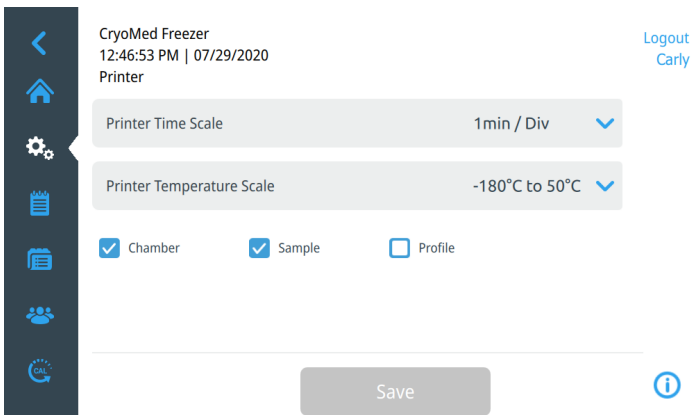

Figure 35. Settings (Printer) Screen

Here you can adjust the Printer Time Scale and Temperature Scale from the given respective drop down menus:

- **Printer Time Scale:** Can specify 1, 2 or 5 minutes per division on the thermal printer chart printout.
- **Printer Temperature Scale:** Can specify from -180°C to 50°C or -100°C to 50°C temperature range to plot on the thermal printer chart printout.
- You can also enable or disable the visibility of the Chamber, Sample and Profile plots on the chart printout.

Select Save button to apply all changes.

Display

When you select Display, the following screen is displayed:

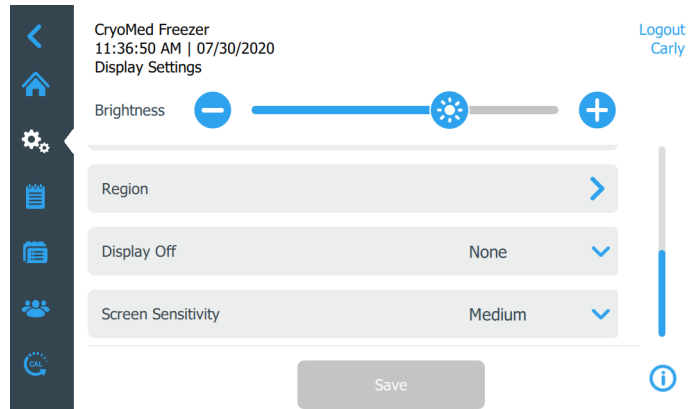
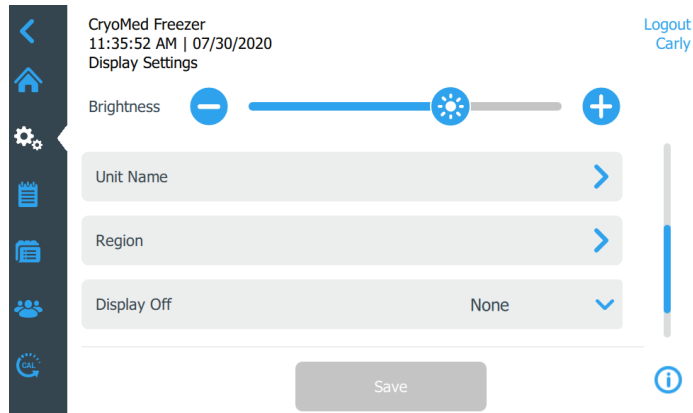
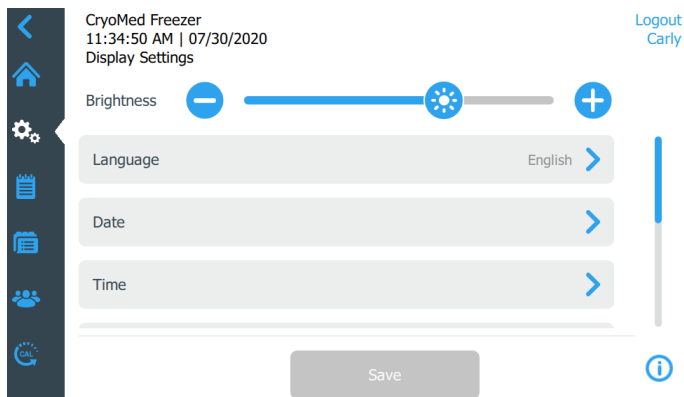

Figure 36. Settings (Display) Screen

- **Brightness:** Use the slide control or the +/- buttons to adjust the brightness level of the display.
- **Language:** To change the display language, press the Language button and select the desired language.



Figure 37. Language Screen

- **Date:** To set the date and the date format, press the Date button.



Figure 38. Date Screen

- **Time:** To set the time and time format, press the Time button.

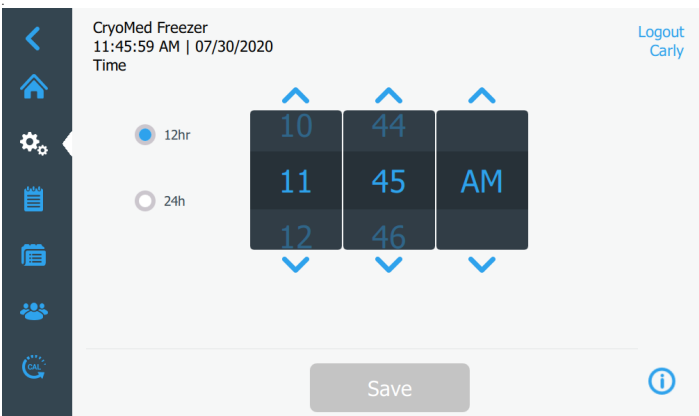

Figure 39. Time Screen

- **Unit Name:** To enter or change the unit name, press the Unit Name button.
- Note:** The Serial Number will be appended to the unit name.

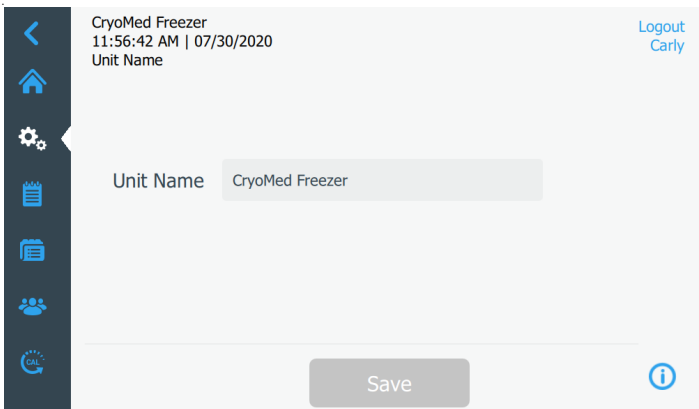

Figure 40. Unit Name Screen

- **Region:** This is used to set the country and city the Controlled-Rate Freezer is operating from.

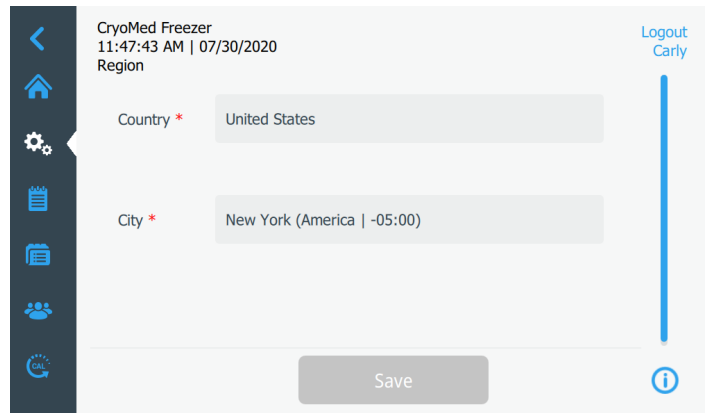

Figure 41. Settings (Region) Screen

- **Display Off:** Allows the display to automatically be off from 9 PM to 6 AM.

Select Save button to apply changes.

Connectivity

The Connectivity tab is used to setup a wireless network and connect to InstrumentConnect. Be sure to follow both steps to store information on InstrumentConnect.

The following screen is displayed when the Connectivity button is selected.

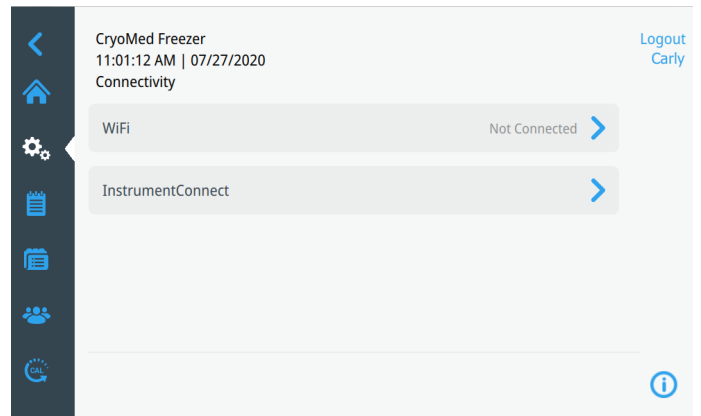

Figure 42. Connectivity Screen

WiFi

Press the WiFi button to connect to a network. Select the network from the list and press the Next button.

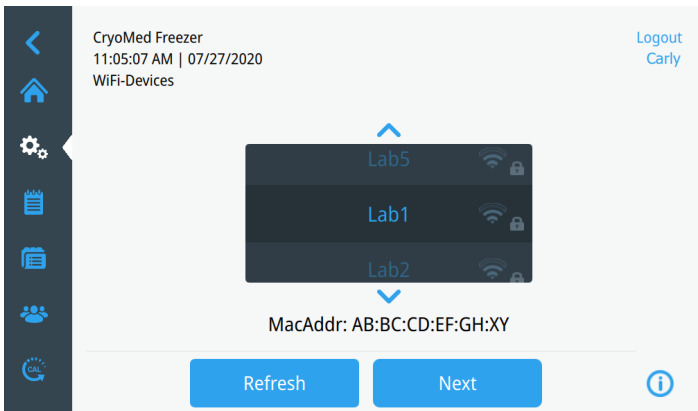

Figure 43. WiFi Devices Screen

There are 2 ways to connect to the network

Option 1: WPA2

Enter the network password and press the Join button.

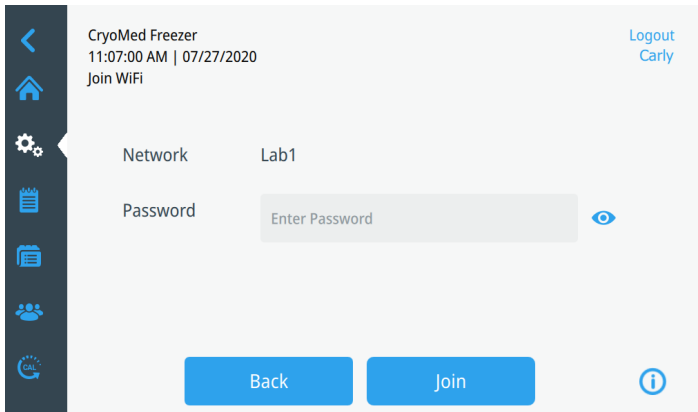

Figure 44. Join WiFi Network Screen.

Option 2: Enterprise networks with optional certificate validation (PEAP)

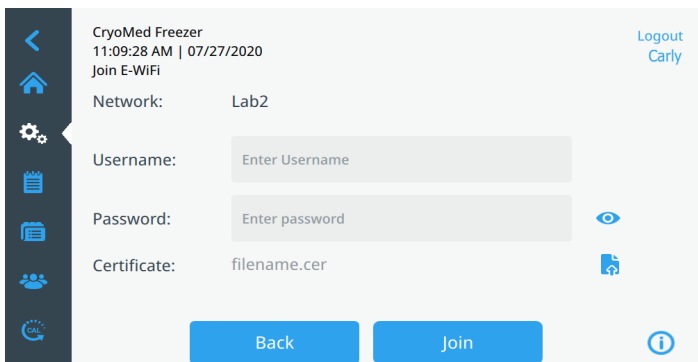

Figure 45. Networks without certificate validation (PEAP)

Press Join to connect to the wireless network.

A success message is displayed once the connection is established. If the connection fails, either due to an incorrect WiFi password or network incompatibility, a general error message is displayed. After 5 seconds, the interface will return to the previous screen.

If this occurs, check the network status and re-enter the correct password to establish the connection. (Tip: use the eye icon to verify the password entry before attempting connection). Refer to connectivity troubleshooting in **Connectivity Troubleshooting** section for additional support.

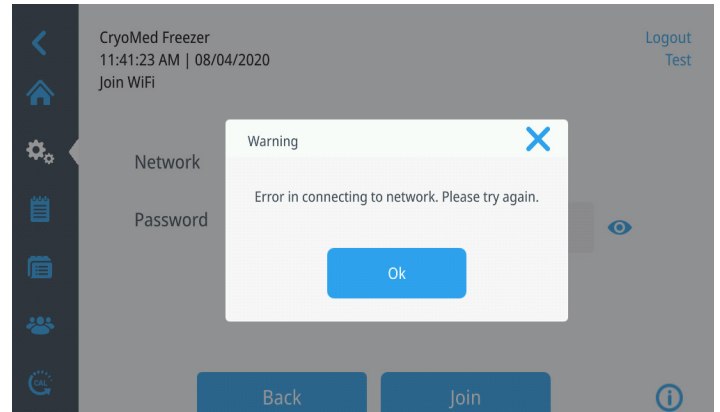

Figure 46. Wireless Setup Error Message Screen

Removing WiFi Connection

To remove an established connection, first select the network you wish to disconnect from within the selection screen shown in **Figure 43** and press the Next button. On the following network information screen, press the Forget Network button. You will be prompted to confirm your selection. Once the connection has been disabled, the screen will return to the WiFi Device selection screen pictured in **Figure 43**

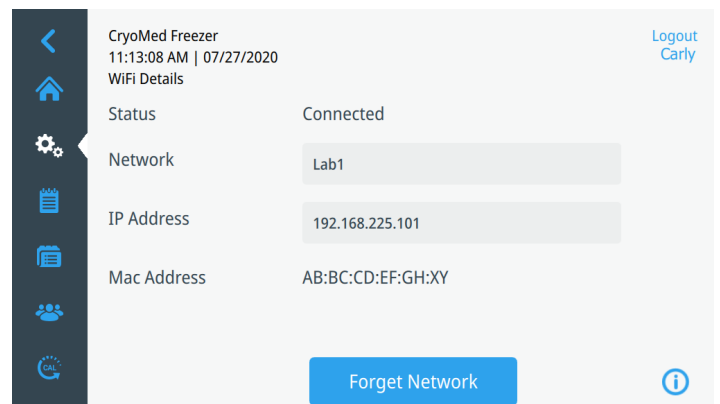

Figure 47. Wireless Setup Connection Message Screen

InstrumentConnect

The following screen is displayed when you press the InstrumentConnect button in **Figure 42**.

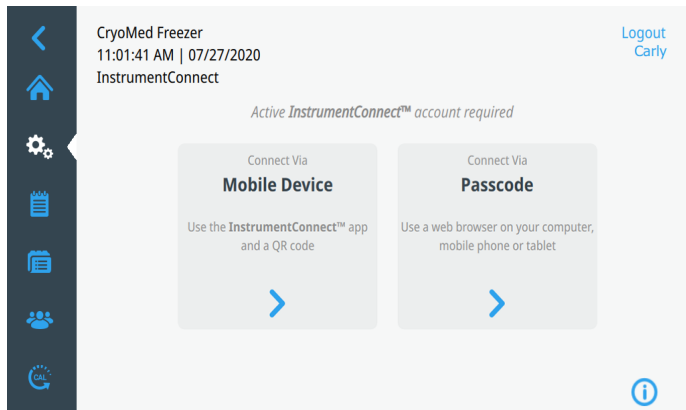

Figure 48. InstrumentConnect Screen

Connect via Mobile Device

Selecting the Connect via Mobile Device option displays a screen with instructions. Follow the instructions to connect to InstrumentConnect.

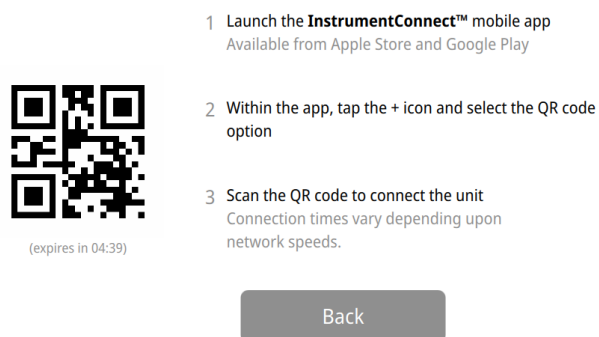

Figure 49. Connect to InstrumentConnect (via Mobile Device) Screen

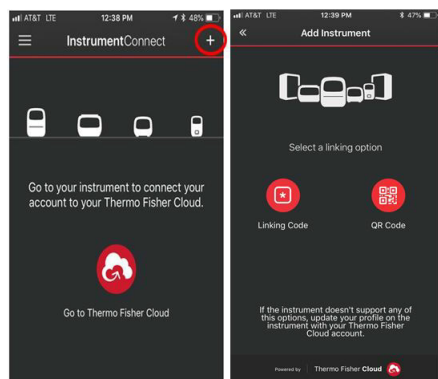

Figure 50. InstrumentConnect Mobile Device Screens

Connect via Pass code

This option displays a code that has to be entered to connect to InstrumentConnect.

Connect to the InstrumentConnect

1. Sign in to InstrumentConnect via <https://apps.thermofisher.com>
2. Go to Instrument Page
3. Add an instrument with code provided

A0C1X5
(expires in 04:45)

This page closes once the code is accepted.

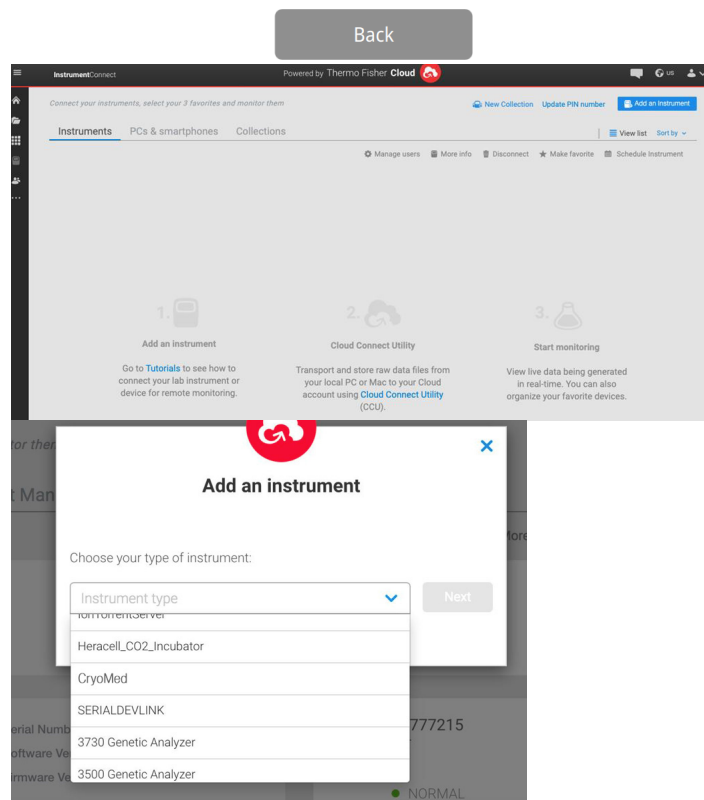

Figure 51. Connect via 1-Time Pass code Screen

Note: When using the InstrumentConnect web and mobile app, ensure you are in the correct regional environment. If you are in China, you should select the China region. Refer to Section **Connectivity Requirements** for more details.

If the connection is successful via either of the two methods, a success message is displayed.

If the connection is unsuccessful, an error message is displayed. After 5 seconds, the interface will return to the previous screen. Check the network status and any entered passwords, etc. and repeat the previous steps to establish a successful connection.

Refer to **Connectivity Troubleshooting** section for more connectivity troubleshooting.

Security

Once you press the security button you will be navigated to the following screen.

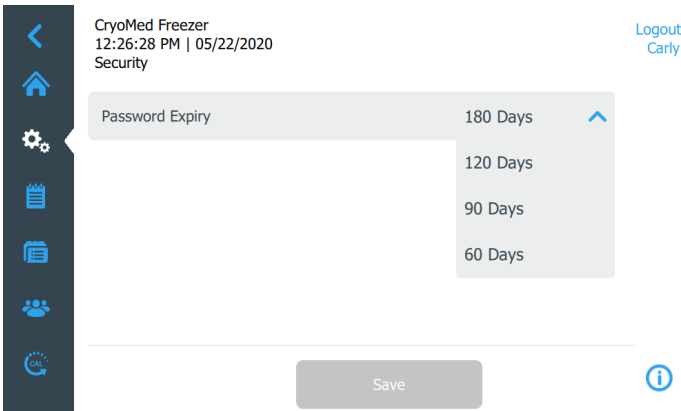

Figure 52. Settings (Security) Screen

This screen is used to select the time period for Password Expiry. You can select the time period from the drop down menu.

Select Save button to apply changes.

About

Once you press the About button you will be navigated to the following screen.

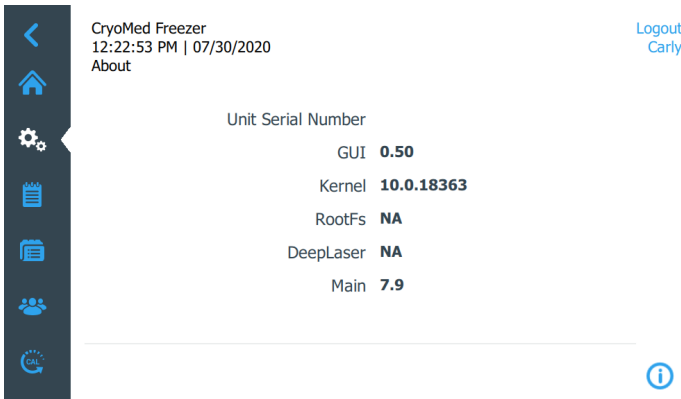

Figure 53. Settings (About) Screen

This screen lists the software version information and Unit Serial Number.

Logs

The third tab on the left navigation bar is the Logs tab. Once you press on the logs button you will be navigated to the

following screen which contains the Event Log and Run Logs buttons.

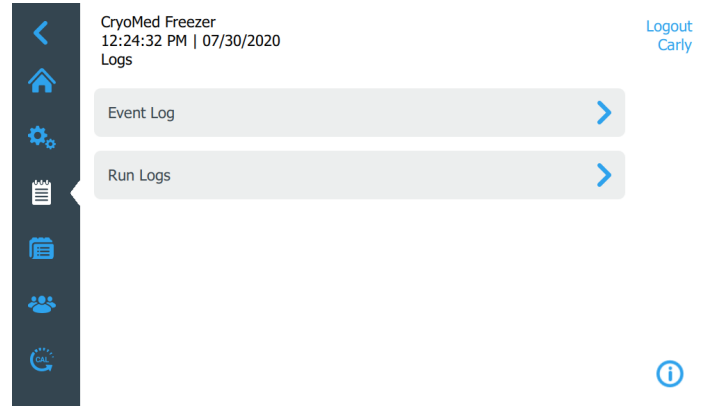

Figure 54. Logs Screen

Event Log: All events that have occurred on the unit are recorded.

Run Logs: Collection of all profiles that have been run on the unit.

Event Log

When you press the Event Log button, the following screen will display a list of the most recent events.

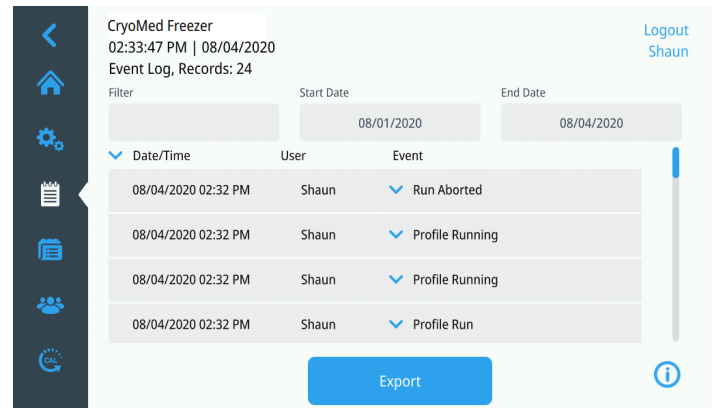

Figure 55. Event Log Screen

A list of events that have occurred in the last 3 days in descending order will come up as a default list.

You may sort the list by pressing on Date/Time, User or Event in the header row. However you can change it according to your requirements.

Filter allows free text to be entered in the header row. The list will filter wherever the occurrence of that specific word occurs. Up to 3 commas separated text entries (e.g a,b,c) can be entered.

You may scroll down the page using the scroll bar to see the events. Pressing on an event will expand the event detail and

provide more details. As you scroll down the list additional available data will be displayed.

When the list has been sorted and filtered, press on the Export button, and the following screen will be displayed:

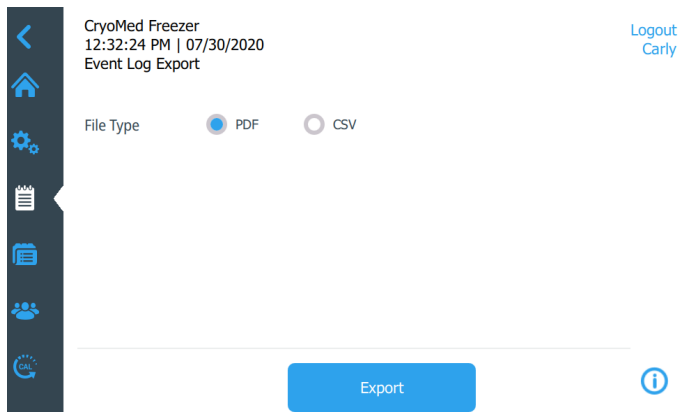

Figure 56. Event Log (Export) Screen.

Select the File Type for output, either PDF or CSV.

You can export a maximum of 2500 available logs.

Note: PDF is the only file format that supports 21 CFR part 11

Press the Export button. A pop-up screen as shown below will display indicating the export to USB was successful.

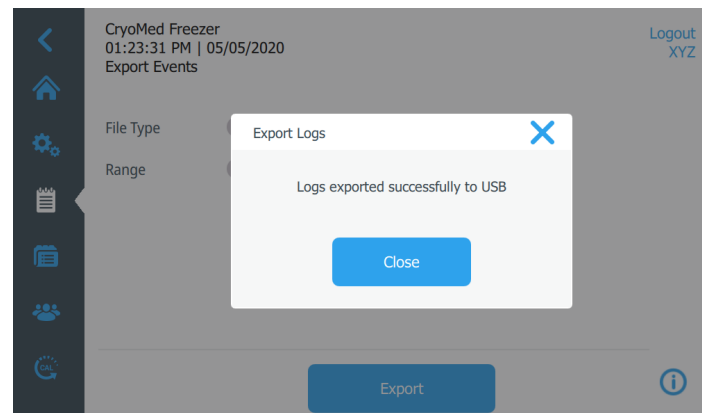

Figure 57. Logs Exported Screen

To close the pop up screen press OK or .

Make sure the USB device is installed properly in the port and has enough storage space to record the exported logs.

If the device is not properly installed and/or does not have enough storage space, a warning message will be displayed as shown below:

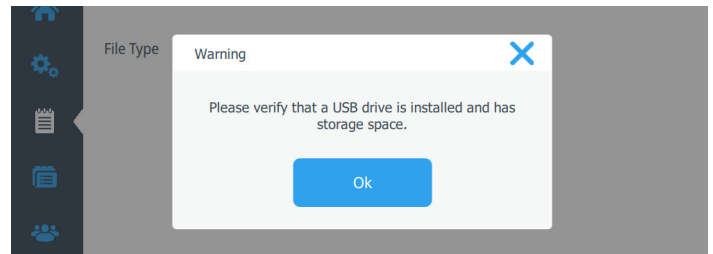

Figure 58. Logs Export Warning Screen

Run Logs

When you press on the Run Logs button you will be navigated to the following screen:

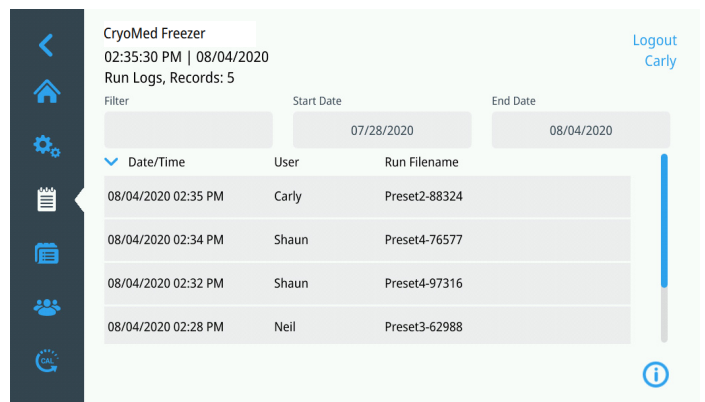

Figure 59. Run Logs Screen

A list of the most recent runs are visible. Press on a run list entry to review the run. Reference the Run Review section for more detail.

You can sort the list by pressing on Date/Time, User or Run Filename in the header row.

Filter allows free text to be entered. The list will filter where ever the occurrence of that word occurs. Up to 3 comma separated text entries (e.g., a,b,c) may be entered. Note, Custom Fields and Field names are also part of the filter.

Profiles

The fourth tab on the left navigation bar is the Profiles tab. Once you press on the profiles button you will be navigated to the following screen:

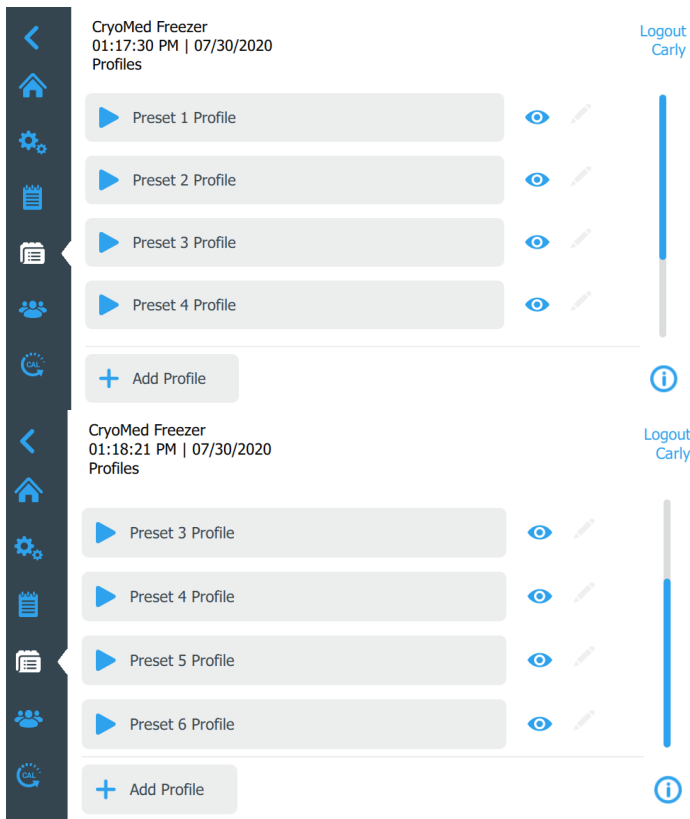



Figure 60. Profiles Screen

The Controlled-Rate Freezer has 6 preset freezing profiles. These profiles cannot be edited.

Note: Add Profile is enabled only when Admin User is logged in.

Press the specific profiles Run button  to initiate the profile.

To view the profile steps, press the eye symbol beside that profile . A pop-up with the specific profile steps will be displayed as shown below:

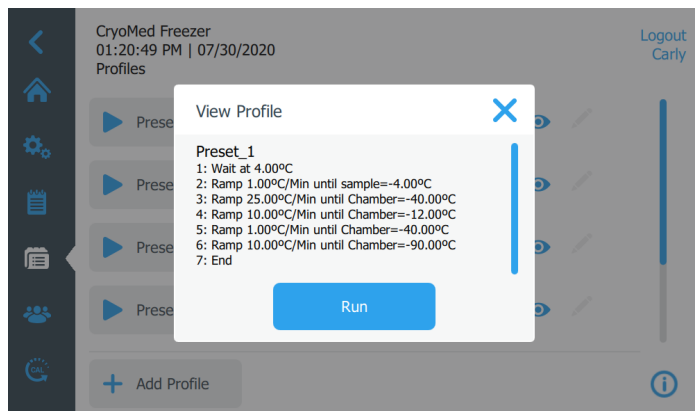

Figure 61. View Profile Screen

You may run the profile by pressing the Run button or you can close the pop-up screen and choose a different profile to run. For more details go to **Active Run Summary** section.

The following units are used to control the individual steps of a given profile:

S = Sample Probe Temperature

C = Chamber Probe Temperature

C/m = Degrees Centigrade per Minute

The pre-set profiles are listed below:

Preset_1: Commonly used for 2.0ml sample size, resulting in a 1°C rate from nucleation to -40°C and a 10°C per minute cooling rate to a -90°C end temperature.

Step 1	Wait	at 4.0°C
Step 2	1.0°C/m S	to -4.0°C
Step 3	25.0°C/m C	to -40°C
Step 4	10.0°C/m C	to -12.0°C
Step 5	1.0°C/m C	to -40°C
Step 6	10.0°C/m C	to -90°C
Step 7	End	

Preset_2: Commonly used for very small (96 well) sample size, resulting in a 1°C rate from nucleation to -40°C and a 10°C per minute cooling rate to a -90°C end temperature.

Step 1	Wait	at 4.0°C
Step 2	1.0°C/m S	to -40°C
Step 3	10.0°C/m C	to -90°C
Step 4	End	

Preset_3: Commonly used for hemopoietic stem cells that are 65-100ml in size, resulting in a 1°C rate from nucleation to -45°C and a 10°C per minute cooling rate to a -140°C for end storage at cryopreservation temperatures.

Step 1	Wait	at 20.0°C
Step 2	1.0°C/m S	to -6.0°C
Step 3	25.0°C/m C	to -50°C
Step 4	10.0°C/m C	to -14.0°C
Step 5	1.0°C/m C	to -45°C
Step 6	10.0°C/m C	to -140°C
Step 7	End	

Preset_4: Commonly used for hemopoietic stem cells that are 65-100ml in size, resulting in a 1°C rate from nucleation to -45°C and a 10°C per minute cooling rate to a -90°C for end storage at ultra low temperatures.

Step 1	Wait	at 20.0°C
Step 2	1.0°C/m S	to -6.0°C

Step 3	25.0°C/m C	to -50°C
Step 4	10.0°C/m C	to -14.0°C
Step 5	1.0°C/m C	to -45°C
Step 6	10.0°C/m C	to -90°C
Step 7	End	

Preset_5: Commonly used for skin packets, resulting in a 1°C rate from nucleation to -35°C and a 10°C per minute cooling rate to a -90°C end temperature.

Step 1	Wait	at 4.0°C
Step 2	1.0°C/m S	to -5.0°C
Step 3	20.0°C/m C	to -40°C
Step 4	10.0°C/m C	to -10.0°C
Step 5	1.0°C/m C	to -35°C
Step 6	10.0°C/m C	to -90°C
Step 7	End	

Preset_6: Commonly used for hemopoietic stem cells that are 65-100ml in size, resulting in a 0.5°C rate from nucleation to -20°C and a 1°C per minute cooling rate to a -80°C end temperature.

Step 1	Wait	at 4.0°C
Step 2	1.0°C/m S	to -4.0°C
Step 3	20.0°C/m C	to -45°C
Step 4	10.0°C/m C	to -10.0°C
Step 5	0.5°C/m C	to -20°C
Step 6	1.0°C/m S	to -80°C
Step 7	End	

Add Profile

If you want to add a profile with custom steps, press on Add Profile on the Profile Screen ( Add Profile). Up to 14 Custom Profiles may be added with different names for each profile.

When you add a profile they will be listed below the 6 preset profiles

Note: Only Admin users can Add Profiles.

When you press on the Add Profile button you will be navigated to the following screen:

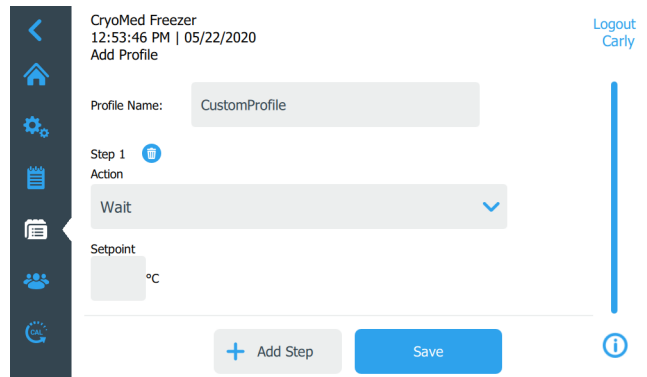

Figure 62. Add Profile Screen

You may create a profile by assigning the profile name and steps as needed. There is a maximum of 20 steps per profile.

The Action field of each step must be set to one of the following commands available in the drop-down menu:

Wait:

WAIT AT X.X°C SET TEMPERATURE.

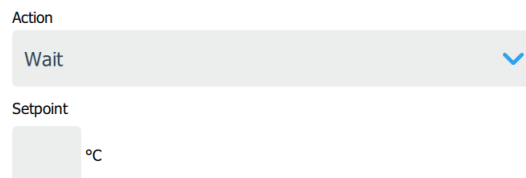

Figure 63. Wait Command

Wait maintains the specified chamber temperature indefinitely until the user selects the Advance button on the Active Run screen. The temperature can be set over the -180°C to +50°C range, with a setting resolution of 0.1°C.

Wait For:

WAIT AT CHAMBER=X.X°C UNTIL SAMPLE=Y.Y°C.

- X.X is Chamber set temperature and Y.Y is the Sample trip temperature.
- The default Sample trip temperature is 1°C above Chamber temperature.

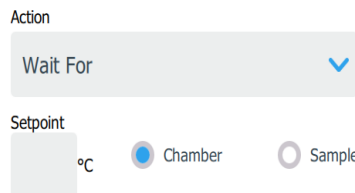

Figure 64. Wait For Command.

Wait For maintains the specified Chamber temperature and moves to next step in profile when Sample temperature cools

to the specified temperature. This step should be used when the starting Sample temperature is greater than the specified Sample temperature (the Sample is cooling).

IMPORTANT: Step 1 only permits a Wait or Wait For as command to properly start a profile.

Ramp:

RAMP X.X°C/MIN UNTIL CHAMBER=Y.Y°C (or) RAMP X.X°C/MIN UNTIL SAMPLE=Y.Y°C.

- X.X is the ramp rate and Y.Y is the chamber (or sample) endpoint temperature.

Figure 65. Ramp Command

This command changes Chamber temperature from its current value to the Setpoint temperature at the selected rate (°C/minute). The rate can be set over a range of 0.1°C/minute to 99.9°C/minute. The temperature can be set over a range of -180°C to +50°C (±0.1°C). When the chamber reaches the specified temperature, the control moves to the next step in the profile. If Sample is selected, chamber temperature changes at a specified rate until sample reaches specified temperature.

Note: The slope of the temperature ramp is determined automatically, based on the temperature defined and the chamber temperature at the beginning of the step. Entry of a sign (+/-) for the temperature ramp rate term is not allowed.



CAUTION: Steep ramp rates may cause chamber to be much colder/warmer than the sample itself.

Hold:

HOLD X.X°C FOR Y.Y MINUTES.

- X.X is the chamber set temperature and Y.Y is the minutes.

Figure 66. Hold Command

Maintains a specified Chamber temperature for the specified hold duration before proceeding to the next step. The time can be set over a range of 1 to 99 minutes, and the temperature can be set over a range of -180°C to +50°C with a setting resolution of 0.1°C.

Jump To:

JUMP TO STEP X.

- X is the step number.

Figure 67. Jump To Command

Automatically advances to a subsequent step or returns to a previous step in a freezing profile. The Jump function can be programmed over a range of Step 1 to END Step.

Loop:

LOOP X TIMES STARTING AT STEP Y.

Figure 68. Loop Command

X is number of repetitions and Y is the step number to repeat. Automatically advances to a subsequent step or returns to a previous step in a freezing profile for a programmable number of repetitions. The Loop function can be programmed from Step 1 to END Step, and over a range of repetitions from 1 to 99.

End:

End the profile at that step.

Note: Each profiles last action step must be END.

End Command.

After entering all your requirements for the specific profile press on Save to apply changes. The profile will be saved and displayed on the Profile List.

Note: To edit a single line of a profile, enter View Mode, scroll to the desired profile step and Edit.

Users

The fifth tab on the navigation bar is the Users icon and it contains a list of both active and inactive users. The list will be displayed only when a Admin User is logged in. When a user is logged in and when they press on Users they can only see their user profile and they can only edit their Name, Email ID and Password but not the User Role. The following screen will be displayed once the Users icon is selected:

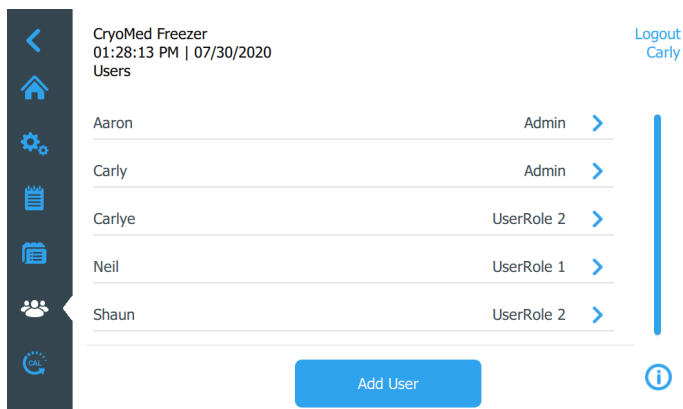

Figure 69. Users Screen

Adding New Users

Press the Add User button to navigate to the Add a User screen:

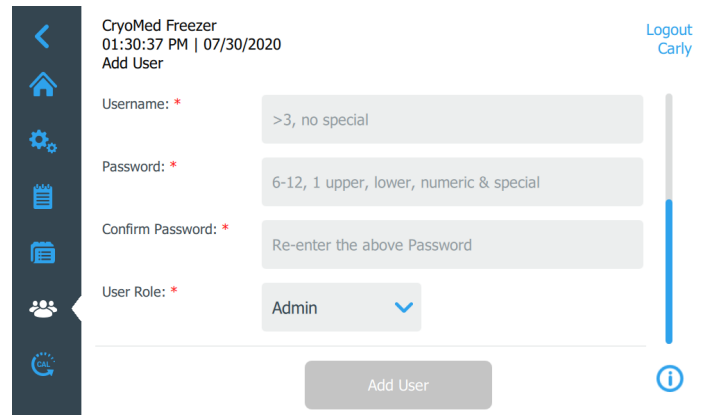
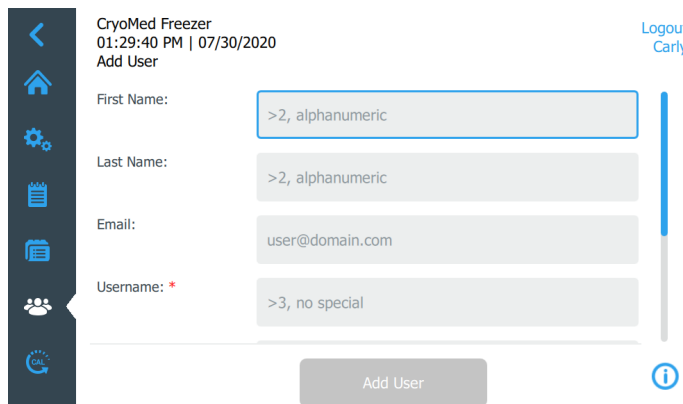

Figure 70. Add a User Screen

Fill in the information in the fields and press on Add User. An asterisk(*) denotes a required field.

- **First Name:** Enter the user's first name. (First Name should be more than two letters and should contain only alphanumerics)
- **Last Name:** Enter the user's last name. (Last Name should be more than two letters and should contain only alphanumerics)
- **Email:** Enter the user's email address. (Email should be in this format user@domain.com)
- **UserName:*** Enter the username as required. (UserName should be more than 3 letters and alphanumerics, no special characters are allowed in username)
- **Password:*** Enter and confirm a user password. (The password entered should be 6-12 characters long and should have at least 1 uppercase, 1 lowercase, 1 number and 1 special character)
- **Confirm Password:*** Re-Enter the password in this to match the above entered password.
- **User Role:*** Select the access level for the user.
 - **Admin:** This user has access to change settings and manage profiles.
 - **User Role 1:** This user has access to change basic functionality of their user profile and can view and adjust Display and Printer settings in settings tab.
 - **User Role 2:** This user has access to change basic functionality of their user profile and can view and adjust Display, Printer and about settings in settings tab. This User cannot access Logs tab.
 - For more information on user role access refer to **Appendix A: User Role Summary.**

IMPORTANT: Once a username is added to the database it cannot be edited or deleted. This feature ensures full traceability to changes made by both active and inactive users.

Note: Only Admin Users can perform the Add User function. Username should be unique so that traceability of events to the users can be maintained.

Editing Users

To edit an existing user, press the user entry in the Users screen and the Edit User Screen will be displayed. Make the required edits by selecting the appropriate field and changing the information. After making the changes, press the “Update User” button. If the password needs to be reset, press the “Reset Password” button as shown in the below figure.

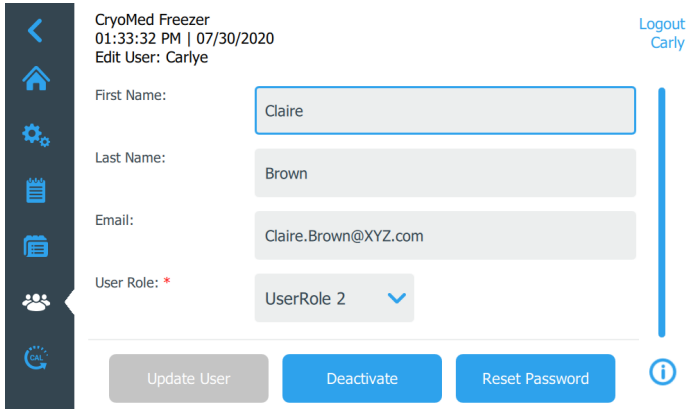

Figure 71. Edit User Information Screen.

When you press on Reset Password button a pop-up box would be displayed for user confirmation to reset the password. When the user presses on “Yes” a PIN will be generated on the screen as shown below:

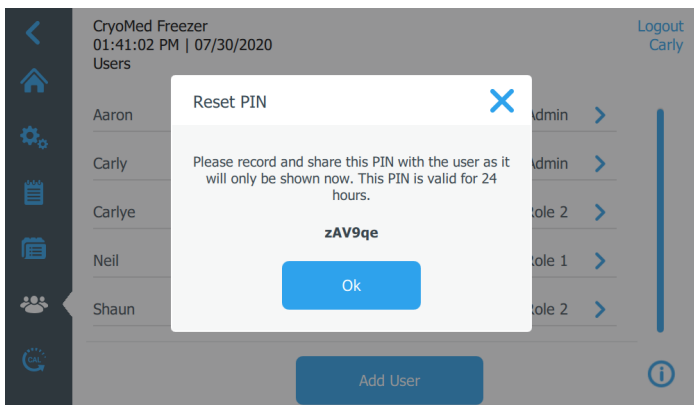

Figure 72. Reset PIN Screen

User should login to the unit using the PIN and reset their password.

Once User details have been saved you cannot delete the user but you can set their User role to Inactive by pressing “Update User”. Once a user has been set as Inactive, that user can no longer log into the unit and perform operations.

Note: There may be multiple users with admin privileges and there is no limit to the total number of users.

Calibration

The sixth tab on the navigation bar is the Probe Calibration icon. The following screen will be displayed once the Calibration icon is selected:

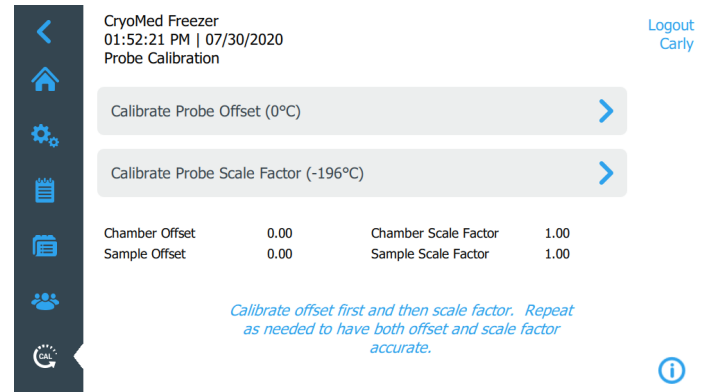

Figure 73. Calibration Screen

Calibration is a two step process: Offset and Scale Factor.

First complete the Offset calibration and then complete the Scale Factor calibration to get accurate results. If the Offset calibration is not completed before the Scale Factor calibration, it may impact temperature measurement accuracy.

Note: Only Admin User can perform calibration and save the result. User may only see the current calibration values.

Note: An ice water bath is required for Offset calibration and an LN₂ bath is required for Scale Factor calibration.

Note: User must remove chamber probe from the chamber sleeve for calibration as shown in the figure below, after completion re-install the probe in the sleeve, aligning the blue heat-shrink marked location on the probe with the top of the sleeve.



Figure 74. Chamber Sleeve

Calibrate Probe Offset

Before starting the Offset calibration insert both chamber and sample probes in an ice water bath. Pressing Probe Offset will display the following screen.

A 5 minute timer will begin and the Offset calibration will start.

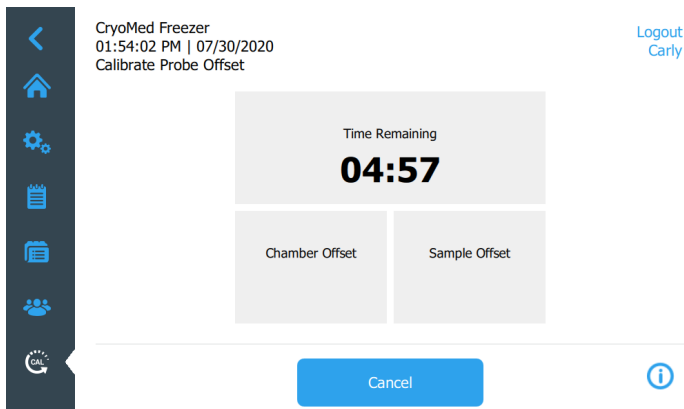

Figure 75. Calibrate Probe Offset Screen

After 5 minutes you can view the offsets per probe. Save the calibration results by pressing the Save button and return to the menu by pressing the back button in the top left as shown below:

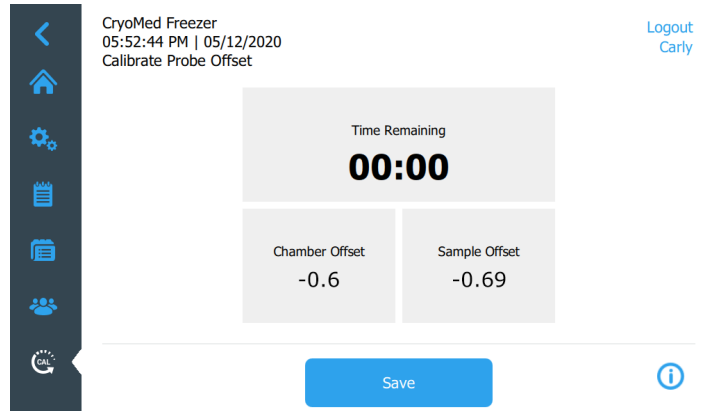

Figure 76. Offset Result Screen

Calibrate Probe Scale Factor

Before starting the Scale Factor calibration insert both chamber and sample probes in LN₂. Pressing Calibrate Probe Scale Factor will display the following screen.

A 5 minute timer will begin, and the Scale Factor calibration will start.

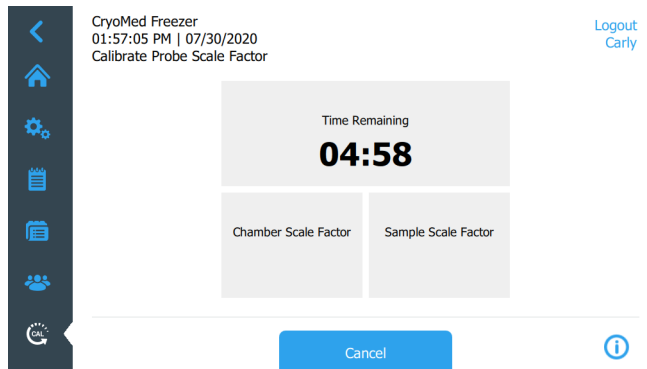

Figure 77. Calibrate Probe Scale Factor Screen

After 5 minutes you can view the scale factors per probe. Save the calibration results by pressing the Save button and return to the menu by pressing the back button in the top left as shown below:

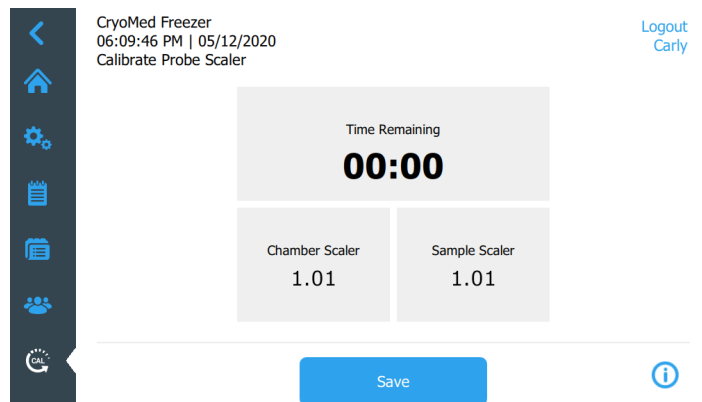

Figure 78. Scale Factor Result Screen

Active Run Summary

A Profile Run can be initiated from the **Profiles** tab or from the **Run Last** button on the Home screen.

Initiate a Run

1. Load the product into the freezing chamber.
2. Select the **Profiles** tab.
3. Select the desired profile and press the Run button you will be navigated to the Run Information Screen.
4. Enter run information as needed and press the Start Run.

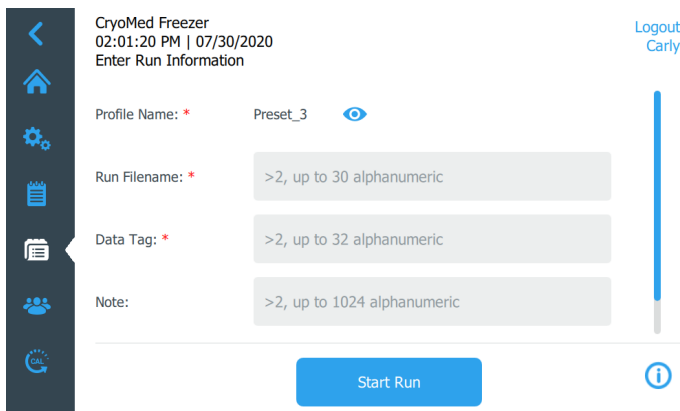

Figure 79. Enter Run Information Screen

5. Once the profile is started, the profile run screen will be displayed as shown in **Figure 80**.



Figure 80. Profile Run Screen.

The mode indicator will show the status and current step of the profile. (Running: Preset_1, Step 3)

Note: When a profile is initiated and the user is logged out they cannot perform other operations on the screen.

Note: When a profile is running the left navigation pane is not visible.

You may zoom in and out in the chart region.

You may also pan tab views on the right pressing the left or right arrows on the Profile Screen section </> or by swiping left or right.

- **Profile:** This view lists the steps of the actively running profile.
- **Legend:** This view associates the series name and color.
- **Information Fields:** This view gives you the information about Date/Time, User, Data Tag, Profile Name, Run File Name, Note and any custom fields which you have entered before running a profile.
- **Alarm Details:** This view lists all alarms that have occurred during the run, up to the current time.

When a profile is running and any alarm occurs, icons of that specific alarm will be displayed on the screen below the graph lines.

When you press the icon you can see which alarm has occurred. Refer **Alarms** section for more information

Manual Override

The user may override a running profile by manually injecting LN₂ or activating the heater to alter the cooling or heating effect.



CAUTION: The manual override function deviates from the profile and should not be used to achieve cabinet temperatures below -180°C. Manual override events are not recorded in run log, but are recorded in the event log.

1. During a running profile, the unit will enable the functions listed below provided a user is logged in.
2. Select the desired function to override (Warm, Cool or Cool+) by pressing the specific icons.

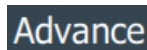

Advance: Advances to next step of the profile.

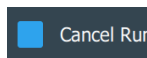

Cancel Run: Cancels the run. User must confirm the selection.



Cool: Energizes the cool solenoid.



Cool+: Energizes both the cool and cool + solenoids.



Warm: Maximum heater output.

Note: Advance button will be displayed only when the first step of the profile is a wait command. Advance must be pressed to proceed to the next profile step.

3. Press and hold the required Icon to turn On the selected function. The function will revert to normal profile control when the icon is released or after 20 seconds function will time out.

Note: Manual override options are temporary inputs, and the automatic control is still active after manual control completes. For example, if the Cool function is activated under manual override and the chamber drops below the programmed set point, the controller will activate the Heat function to compensate.

Stop a Profile Run

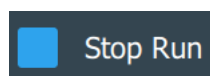

A run may be discontinued by pressing the Cancel Run button. Cancel Run is only available until the last step of a profile.

Cancel Run must be confirmed by the user and a partial run file will be generated.

When a run completes, press the stop button to generate a Run review file.

If a power outage interrupts a run, the profile will continue to collect the data but LN₂ and heater control is not possible until power returns.

Note: By viability assessment protocol, the user should assess the sample viability after the samples are thawed and before its end application.

Note: Because so many factors affect the freezing and warming rates of a temperature profile (see **Specifications** section) all new, user-specific profiles should be verified for accuracy before applying to samples.

Run Review

When the Run is completed you can review the Run by pressing the **Prior Run Review** on the Home screen or from **Run Logs** from **Logs** section.

Once you select a run for review you can see the details of that specific run as shown below:



Figure 81. Run Review Screen

Here you can view the details of the specific run and can print or Export the details. Print option is available if the unit is equipped with a printer. If your unit does not support Print option then the option will be disabled.

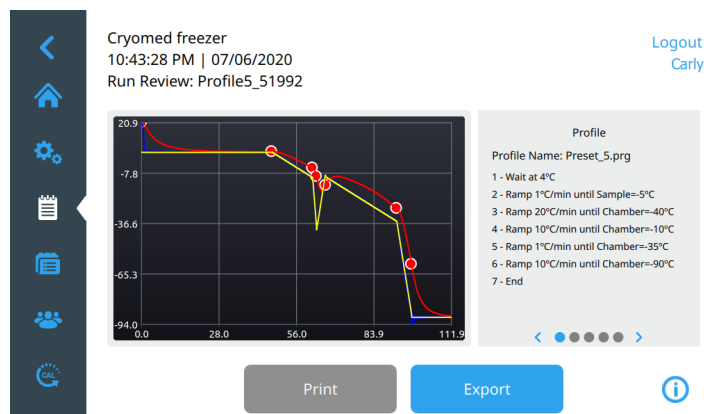

Figure 82. Run Review (Print) Screen

You may zoom in and out in the chart region.

You may also pan tab views on the right pressing the left or right arrows on the Profile Screen section / or by swiping left or right.

- **Profile:** This view lists the steps of the profile.
- **Legend:** This view associates the series name and color.
- **Information Fields:** This view gives you the information about Date/Time, User, Data Tag, Profile Name, Run File Name, Note and any custom fields which you have entered before running a profile.
- **Alarm Detail:** This view lists all alarms that have occurred during the run, up to the current time.
- **Slope Data:** This view summarizes the least square calculated slopes for the chamber and sample per step.

Once you press on the Export button following screen will be displayed:

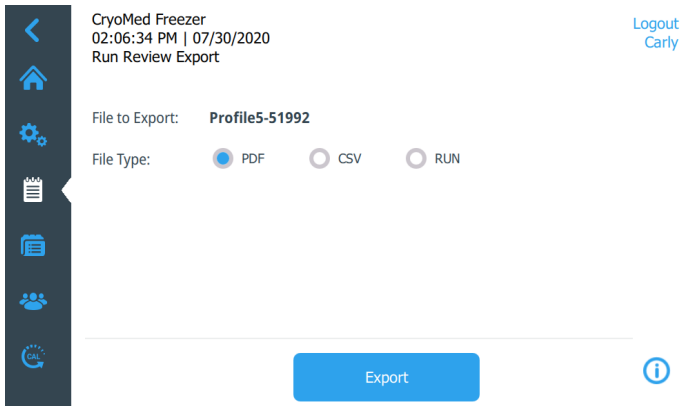

Figure 83. Export Run File Screen

Select the File Type of the exported file to be either PDF, CSV or RUN. Press on Export button.

Note: PDF is the only file format that is CFR21p11 compliant.

A pop-up screen as shown below will be displayed indicating the export to USB was successful.

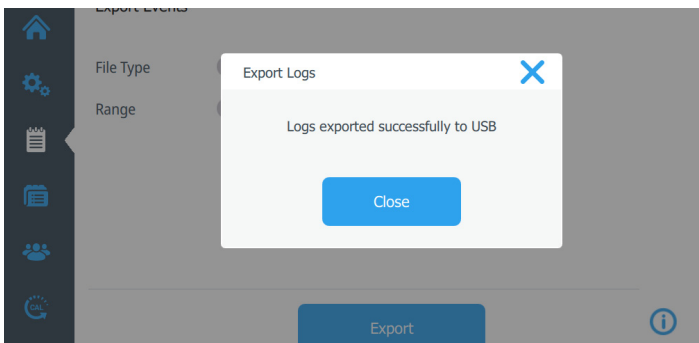

Figure 84. Logs Exported Screen

Alarms

General Alarm Guidelines



During an active run, all alarms will display a red bell icon on top of the screen. Outside of an active run, only the Power Failure alarm will display the red bell icon.



Alarms are silenced by pressing the alarm icon. Once pressed, the alarm icon will change to a bell icon with a slash through it.

- All alarms that display the red bell icon will trigger the remote alarm signal. The remote alarm is only cleared by recovering from the alarm. Silencing the alarm does not clear the remote alarm.
- All alarms that display the red bell icon will also raise the alarm buzzer.
- In an active run, alarm icons will be displayed on the run chart at the time they occurred. All alarms are also logged in the Alarm Detail view.



Figure 85. Alarm Detail Screen

Note: Only Power Failure alarms will display the red bell icon, trigger the remote alarm, and activate the buzzer in Idle mode. All other alarms will only do so during Warming mode or an active run.

Alarm Icons

Alarms



Temperature limit,
Temperature tracking



Power Failure



Thermocouple probe failure



LN₂ Malfunction,
Heater Malfunction

Chamber Thermocouple Failure

If the chamber thermocouple cannot be detected or reads erroneous values (>75°C), an alarm will be triggered according to the general alarm guidelines.

A chamber thermocouple failure is considered a non-clearing alarm and will end Warming mode or an active run. Once the failure is detected, a dialog will prompt the user to acknowledge the alarm. Upon acknowledgment, the Controlled-Rate Freezer will return to the Home screen and enter Idle mode. If the Controlled-Rate Freezer was in an active run, a RUN file will be written as if the run was canceled early.

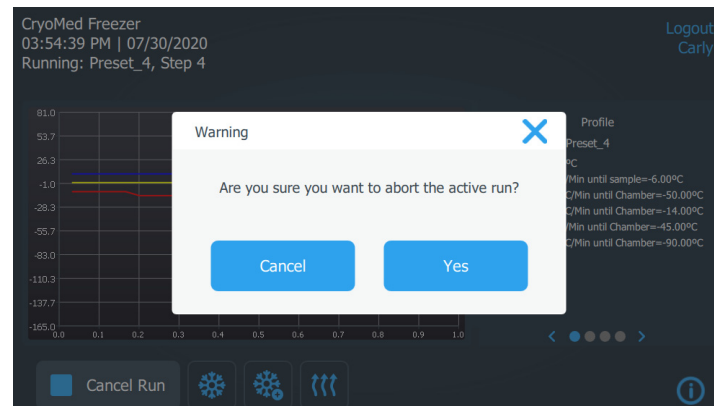

Figure 86. Active Run Cancellation

- The Chamber temperature display on the Home screen shows “...” when a Chamber Thermocouple Failure alarm is active.



Figure 87. Chamber Temperature Display (Home Screen)

- The Chamber temperature display will revert to normal when the Chamber Thermocouple Failure alarm recovers.

Note: Neither Warming mode nor a profile run may be initiated while this alarm is present.

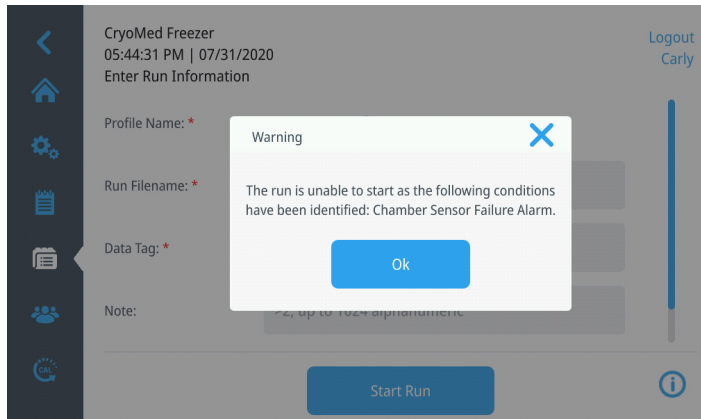

Figure 88. Chamber Thermocouple Failure (Warning)

Sample Thermocouple Failure

If the sample thermocouple cannot be detected or reads erroneous values (>75°C), an alarm will be triggered according to the general alarm guidelines.

The Controlled-Rate Freezer will respond to the alarm in different ways depending upon the current mode and selected freezing profile.

Idle Mode

The Sample temperature display on the home screen shows “...” when a Sample Thermocouple Failure alarm is active.



Figure 89. Sample Temperature Display (Home Screen)

The Sample temperature display will revert to normal when the Sample Thermocouple Failure alarm recovers.

Note: Profile runs cannot be initiated while this alarm is present. Warming mode, however, can still be initiated with a sample probe failure alarm present.

Active Run (Non-Sample Probe Profile)

If the Sample probe fails during a freezing profile which does not reference the Sample probe, the freezing profile will not terminate. An alarm will still be generated according to the general alarm guidelines.

Active Run (Sample Probe Profile)

If the Sample probe fails during a freezing profile which references the Sample probe, the freezing profile will terminate. Once the failure is detected, a dialog will prompt the user to acknowledge the alarm. Upon acknowledgment, the Controlled-Rate Freezer will return to the home screen and enter Idle mode. A RUN file will be written as if the run was canceled early.

Heater Malfunction

If the heater is energized continuously (no active temperature control) for 60 minutes or longer, the Controlled-Rate Freezer will generate a Heater Malfunction alarm according to the general alarm guidelines.

This alarm is considered a non-clearing alarm and will terminate an active run. Once the failure is detected, a dialog will prompt the user to acknowledge the alarm. Upon acknowledgment, the Controlled-Rate Freezer will return to the Home screen and enter Idle mode. A RUN file will be written as if the run was canceled early.

Once the Controlled-Rate Freezer returns to Idle mode and the heater is de-energized, the alarm will automatically clear.



WARNING: If this alarm persists or the heater ceases functioning after an occurrence of this alarm, contact a service representative.

LN₂ Alarm

If one or both LN₂ valves are energized continuously (no active temperature control) for 60 minutes or longer, the Controlled-Rate Freezer will generate an LN₂ Malfunction alarm according to the general alarm guidelines.

This alarm is considered a non-clearing alarm and will terminate an active run. Once the failure is detected, a dialog will prompt the user to acknowledge the alarm. Upon acknowledgment, the Controlled-Rate Freezer will return to the Home screen and enter Idle mode. A RUN file will be written as if the run was canceled early.

Once the Controlled-Rate Freezer returns to Idle mode and the LN₂ valves are de-energized, the alarm will automatically clear.



WARNING: Potential asphyxiation hazard. This equipment should be located in a well ventilated room.

Temperature Limit



CAUTION: Do not allow the sample probe to come into contact with the chamber interior during operation. This could cause a displayed sample probe temperature shift.

If the temperature of the Chamber or Sample probe reaches the chamber design high or low temperatures (design temperature limits are factory preset at +55°C and -185°C), the Controlled-Rate Freezer will generate a Temperature Limit alarm for the relevant probe according to the general alarm guidelines.

This is a “self clearing” alarm and will clear once the temperature in question returns to the designed temperature limit range. If the alarm resolves within 10 minutes, any active run or Warming mode operation will continue uninterrupted.

If the temperature of either probe continuously exceeds the limit temperatures for longer than 10 minutes, any active run or Warming mode will be terminated. A dialog will prompt the user to acknowledge the alarm. Upon acknowledgment, the Controlled-Rate Freezer will return to the Home screen and enter Idle mode. If the Controlled-Rate Freezer was in an active run, a RUN file will be written as if the run was canceled early.

Temperature Tracking Alarm

If the chamber temperature is higher or lower than the programmed temperature during an active run by a pre-determined amount for a pre-determined time period, a Temperature Tracking Alarm will be generated according to the general alarm guidelines.

This is a “self clearing” alarm. When the chamber temperature returns to within the pre-determined range of the programmed temperature, the alarm will clear.

Power Failure

If AC power to the Controlled-Rate Freezer is interrupted, the Controlled-Rate Freezer will detect the power failure and alert the operator that the Controlled-Rate Freezer is under battery

power. The freezer will generate a Power Failure alarm according to the general alarm guidelines.

Active Run

If an active run is ongoing when the alarm occurs, the run will continue without temperature control. The fan and heater will be shut off and the LN₂ valves will remain closed. Once power is restored, temperature control will resume.

Warming Mode

If the freezer is in Warming mode when the alarm occurs, Warming mode will be terminated and the freezer will return to Idle mode on the Home screen.

Idle Mode

During a power failure in Idle mode, Warming mode and active runs may not be initiated. If the user attempts to initiate a run or start Warming mode, a dialog will be generated notifying the user that they are unable to do so.

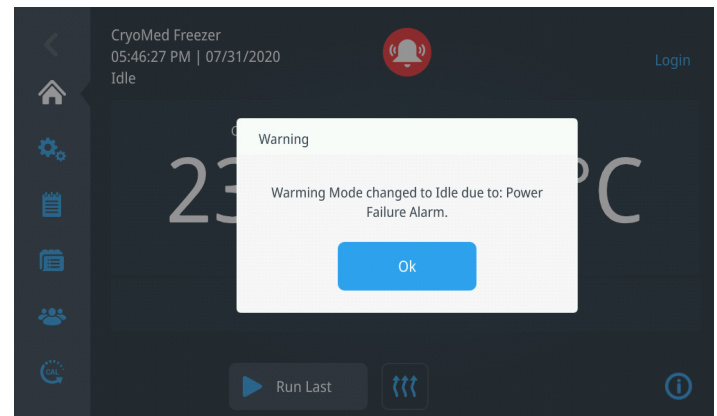

Figure 90. Power Failure Alarm (Idle Mode)

Warm Complete

Five minutes after the chamber reaches 25°C during a Warming mode cycle, the freezer will sound a Warm Complete alarm for 10 seconds.

Note: This alarm is audible only and does not follow the general alarm guidelines for the red bell icon display.

After the Warm Complete alarm is sounded, the Chamber temperature is maintained at 25°C for a period of 30 minutes. After the 30 minutes expires, the freezer is switched to Idle Mode and all temperature controls are disabled.

Printer Set-Up

The built-in thermal printer (optional) has internal software switch settings that control how the printer interfaces with the Controlled-Rate Freezer. These internal settings are pre-set at the factory for proper operation with the freezer. The printer will not be available during power failure. Verify that green power LED is ON and orange error LED is OFF on power up.

Table 4. Lamp Display

Lamp Display	POWER lamp (Green)	ERROR lamp (Orange)
Power OFF	Off	Off
Power ON (Print-ready)	On	Off
Initializing	On	On
Out-of-paper	On	Blink
Paper cover open	On	Blink twice
Thermal head temperature error	Blink twice	On
Hardware	Off	Blink

Change the Paper

1. Turn the printer on.
2. Press the paper cover open button to open the paper cover.

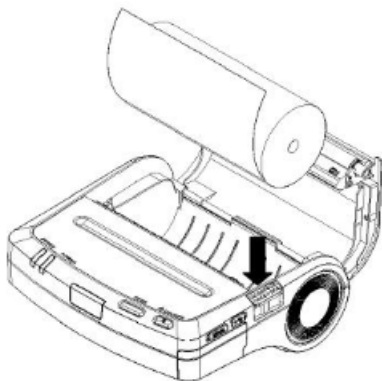

Figure 91. Paper cover open button

3. Install the paper roll into the paper holder. Make sure that at least 5cm of thermal paper protrudes from the paper outlet.

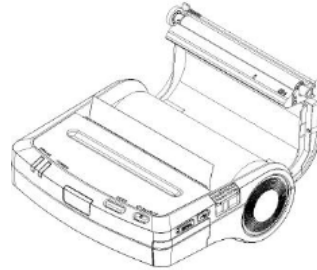

Figure 92. Install the paper roll to the paper holder

4. Press both sides of the paper cover to close the paper cover.

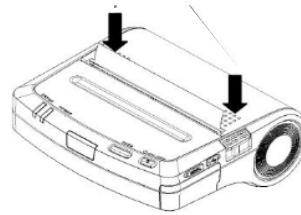

Figure 93. Close the paper cover

5. If a paper roll with a mark is used, press the FEED switch once to feed to the home position.

Specifications

Temperature Uniformity

Temperature uniformity is specified to be less than a standard deviation of 2°C (up to the 'freeze' of the first vial) across a matrix of 10 vials (1.2/2.0ml size) containing 1.0ml (± 2%) each of distilled H₂O. The temperature is to be monitored by type 'T' thermocouples placed in the center of the liquid in each vial with the vials distributed in standard racks and holders as shown below (separately for each cabinet size). Note that there are 5 each vials in the second rack from the top, as well as the second rack up from the bottom, with the 'Sample' vial placed in the center of the top rack. Also, note that the large cabinet uses a combination of the small and mid-size rack and holder sets. Finally, a specific program sequence, listed below, must run in order to collect the uniformity data.

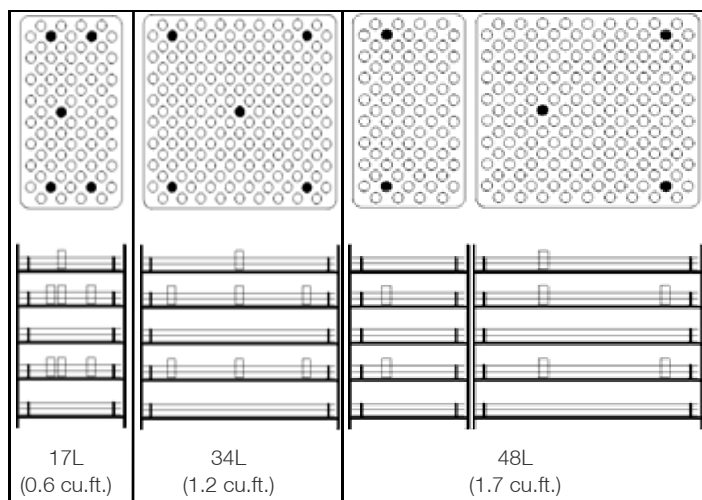

Figure 94. Rack and Holder Vial Placement for each size chamber

Temperature Uniformity Profile With Cryo Bags

Temperature uniformity with 250ml cryo bags set up is specified to be less than a standard deviation of 2°C (up to the 'freeze' of the first cryo bag).

The temperature is to be monitored by type 'T' thermocouples placed on the canister surface under 250ml cryo bag that is filled with 50ml (± 10ml) cryo media (DMEM) in each bag with the cryo bags distributed in standard racks and canisters as shown in **Figure 95** (separately for each cabinet size).

Each standard rack contains 10 shelves where each shelf is loaded with a cryo bag inside a canister. 3 shelves are instrumented with type 'T' Thermocouples i.e., the second,

fifth and eighth shelf from the top, with the 'Sample' bag placed in the top shelf.

Note: Use Type 'T' ribbon probe thermocouple for Sample bag.

- 17L cabinet uses 1 rack and 3 thermocouples.
- 34L cabinet uses 2 racks and 6 thermocouples.
- 48L cabinet uses 3 racks and 9 thermocouples as per cabinet size.

Sample bag location also depends on the cabinet size due to no.of racks per cabinet:

- For 17L, 1 rack with sample bag on top shelf
- For 34L, 2 racks with sample bag on top shelf of rack closer to fan blade
- For 48L, 3 racks with sample bag on top shelf of middle rack

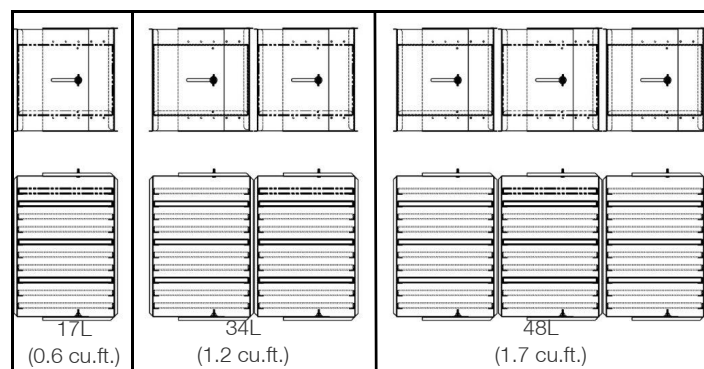

- ➡ Sample bag Shelf location (Type T ribbon probe)
- Instrumented bag shelf location (Type T thermocouple)
- Un-instrumented bag shelf location

Figure 95. Cryo Bags in Standard Racks and Canisters

Uniformity Profile

1. Hold 10.0min @25°C
2. 2.0°C/min C to 0.0°C
3. 0.0°C/min S to 3.0°C
4. Hold 10.0min @1.0°C
5. 1.0°C/min C to -5.0°C
6. 99°C/min C to -50°C

7. 99°C/min C to -10.0°C
8. 1.0°C/min C to -2.0°C
9. Hold 12.0 min @ -2.0°C
10. 1.0°C/min C to -20°C
11. END

Chamber Temperature Range:

+50°C to -180°C

Chamber Freezing Rate:

Minimum 0.1°C / min

Maximum 99.9°C / min over operating temperature range

Note: Rates vary based on load, LN₂ pressure, unit size, and voltage.

Chamber Warming Rate:

Minimum of 0.1°C / min (no load, T-couple in free air, center of chamber)

Maximum of 10.0°C / min (same conditions as above)

Note: Rates vary based on load, LN₂ pressure, unit size, and voltage.

Air Flow:

Horizontal from right to left, as viewed from the front

Sound Level:

Unit in operation does not exceed 77 dBA while the valves are cycling.

Operational Features:

Door interlock switch turns off LN₂, heater and fan motor, except during the warm-up cycle.

During the warm-up cycle, the door can be opened with heater and fan running to accelerate warming.

LN₂ pressure relief valve located adjacent to LN₂ connection.

Chamber pressure vent port located on left side-wall.

Heater over temperature protection: At a temperature level of 93°C, an independent manual reset device interrupts power to the heating element.

External Connections

- Power entry
- PC interface port
- LN₂ connection 1/2" flare
- Remote alarm
- WiFi dongle
- UI USB

Electrical

- TSCM17PA, TSCM34PA, TSCM48PA, TSCM17XA, TSCM34XA, TSCM48XA.
 - Nominal: 120VAC, 60Hz, 1PH, 12.0 FLA
- TSCM17PV, TSCM34PV, TSCM48PV, TSCM17XV, TSCM34XV, TSCM48XV.
 - Nominal: 230VAC, 50Hz, 1PH, 5.5FLA
- TSCM17PL, TSCM34PL, TSCM48PL, TSCM17XL, TSCM34XL, TSCM48XL.
 - Nominal: 100VAC, 60Hz, 1PH, 10.5 FLA
- All models contain a 12V, 2.90lbs (1.32kg) Lead Acid backup battery (5 hour capacity at 2.9AH)

Parts List

Following are the list of consumable and commonly replaced parts:

Table 5. Parts List

Part Number	Description
4000566	Thermal Printer Paper, 5 rolls per box
730036	Teflon Washer
130059	Ampule Stopper
130060	Straw Stopper
4000401	6 ft. Transfer Hose
331757G01	USB (CRF PC interface and User manual)
270158	DB9 Cable, 10 ft.
350185	USB-to-Serial Adapter
328901H01	ADAPTER, WIFI, NANO USB (Dongle)
331210H01	SOLENOID VALVE ,110/120 V ,50/60 HZ, CRF HARNESS
331210H02	SOLENOIDE VALVE 220/240V, 50/60 Hz CRF HARNESS
322533H01	Battery 12V
331215H01	THERMO COUPLE-SAMPLE,CRF HARNESS
331216H01	THERMO COUPLE- CHAMBER,CRF HARNESS
315282H05	SWITCH, ROCKER, 2 POLE, CIRCUIT BREAKER, 8 AMP
315282H04	SWITCH, ROCKER, 2 POLE, CORCUIT BREAKER, 15 AMP
251008	1/4 MPT Relief Valve 60 PSIG
331301H01	Thermal Data Printer
430326	Cord-set, 13A/125V, 16/3, USA
430109	Cord-set, 10A/250V, European
370248	T/C Plug Type T

Accessories

The following are commonly used accessories that may be purchased separately:

Table 6. Freezing Racks and Holders

Catalog No.	Description
4000294	Straw Rack for .25/.5ml straws - holds 40 straws per rack
4000303	Cane freezing rack - large
4000700	Cane freezing racks- small
4000701	1.2/2ml freezing rack - small
4000702	Rack holder for 4000701 racks - small
4000703	1.2/2ml freezing rack - large
4000704	Rack holder for 4000703 racks - large
4000705	4 or 5ml freezing rack - small
4000706	Rack holder for 4000705 racks - small
7000707	4 or 5ml freezing rack - large
4000708	Rack holder for 4000707 racks - small
4000310	Two level skin rack - holds skin packets measuring 5" x 7"
4000312	One level skin rack - holds skin packets measuring 5" x 7"
4000340	Cord blood freezing rack for 50ml canisters (4000610)
4000340	Cord blood freezing rack for 25ml canisters (1950381)
185089	Adjustable freezing rack for canisters

Table 7. Freezing Presses

Catalog No.	Description
4000314	Bag press for 250ml bag (Fenwal 4R5461 or equivalent)
4000316	Bag press for 200ml bag (Gambro DF-200 or equivalent)

Table 7. Freezing Presses

Catalog No.	Description
4000317	Bag press for Delmed 2030-2
4000318	Bag press for 250ml bag (Fenwal 4R5461 or equivalent)
4000320	Bag press for 200ml bag (Gambro DF-200 or equivalent)
4000321	Bag press for 700ml bag (Gambro DF-700 or equivalent)
4000555	Bag press for 500ml bag (Fenwal 4R5462 or equivalent)

Table 8. Sample Sensors

Catalog No.	Description
4000385	Thermocouple sensor for 1.2/2ml vials
4000386	Thermocouple sensor for 4/5ml vials
4000384	Thermocouple sensor .02 sheath for straws
4000393	Thermocouple sensor ribbon type for bags

Table 9. Canisters for Freezer Racks

Catalog No.	Description
1950831	Swing arm canister for 25ml bag
4000610	Swing arm canister for 50ml bag
4000356	Swing arm canister for 200ml bag
4000357	Swing arm canister for 700ml bag
4000335	Sliding arm canister for 250ml bag
4000336	Sliding arm canister for 500ml bag
4000332	Sliding arm canister for 200ml bag
4000333	Sliding arm canister for 700ml bag

PC Interface Software

The CryoMed Controlled-Rate Freezer includes the PC Interface companion software. The PC-based software enables the user to create and download freezer profiles. The software also allows users to remotely initiate a profile run, monitor the run progress, detects and responds to error conditions, and it also enables users to print a report summary of the run data.

The minimum requirements for the interface are as follows:

- Computer: Compatible desktop or laptop computer, 120 MHZ Pentium minimum
- Operating systems: Microsoft Windows 7, 8 or 10.
- RAM: 16 MB
- Available Hard Disk Space: 101.5 MB
- Monitor: VGA color Monitor (800 X 600 minimum)
- Printer: Color or monochrome, Windows compatible
- Mouse: Three-button
- RS-232 Interface or PC USB connection (one for each freezer controlled)

Note: It is the user's responsibility to take reasonable measures to protect the computing devices against viruses and malware infection.

The user ensures that only users with a valid User ID and password can gain access to the Personal computer. Procedures should be developed and maintained to ensure that users do not share their unique user ID and or password.

During the time that the freezer is running a PC-initiated profile (Remote Run), the UI is disabled, and a dialog box will appear on the screen acknowledging that the unit is under remote control.

The PC software communicates with the CRF through the RS-232 serial connection (included with the freezer is a 10' male-female DB9 cable and a USB to Serial Adapter). Data information is routed with a check byte for transmission integrity. The software communicates with the freezer to collect information, such as run data and any alarms.

The Controlled-Rate Freezer companion PC software is optimized to work with Windows 7, 8 or 10. A PC with Windows 7, 8 or 10 can communicate with up to four CRF units. However, our recommendation is to use a dedicated PC for each CRF.

If multiple instances of the software are open and connected to different CRF units through the same PC, it is recommended to minimize the inactive windows or instances of open software not being used. This reduces the load on the CPU and improves the efficiency/productivity of the software.

Installation

A Java Run Time Engine is installed with the PC interface software.

Ensure that both the RS232 extension cable and USB to serial adapter are connected properly between the freezer and the PC. Download and install the USB to serial adapter driver software appropriate for the PC operating system. After installing USB to serial adapter driver verify that the COM port gets reflected in the ports (COM & LPT) section in Device Manager Window.

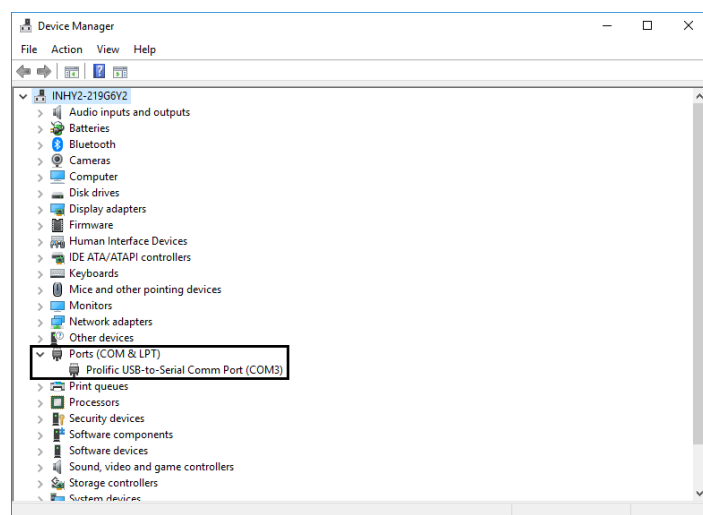

Figure 96. COM Port verification in Device Manager

Note: When using the USB to serial adapter driver software, if installation does not begin when cable is connected to unit, visit cable manufacturer website (cable manufacturer can be found on cable/cable box).

Follow these steps to install and set-up the software on the PC:

1. USB port is required to install the PC Interface application.
2. Non-admin users can install the PC Interface software. However, admin access rights are required to install the Java Runtime Environment (Java). The interface software will run on Java 1.8.0 and later versions. Non-admin users should contact their IT department for software download assistance. While in admin mode, run (download) software as administrator, and continue walking through the following steps.

- When the user inserts the USB into the USB port, they must navigate to the USB port drive location.
 - 64-bit location: PC INTERFACE V3-3/PCI64/PC Interface.exe.
 - 32-bit location: PC INTERFACE V3-3/PCI32/PC Interface.exe.

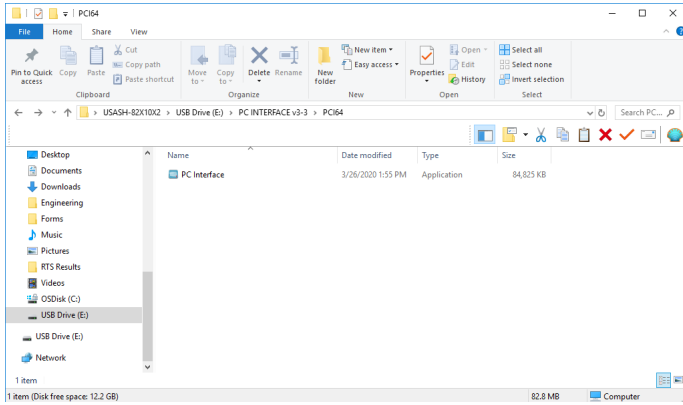

Figure 97. USB port drive location

- A prompt window appears to verify installation location. The default location is indicated in **Figure 98**, or the user can browse to a more desirable location.

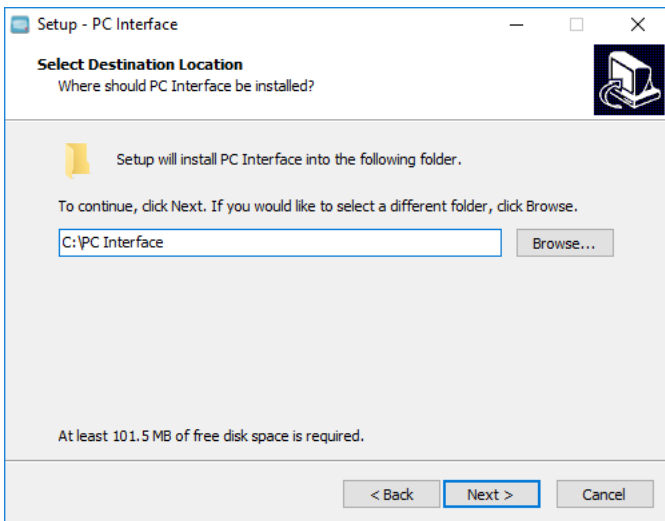

Figure 98. Installation location screen

- Make sure you have enough disk space to install the software (**Figure 98**). If not, you will see an error message. Select Next.
- Check the check box of create a desktop icon is required. See **Figure 99**. Select Next.

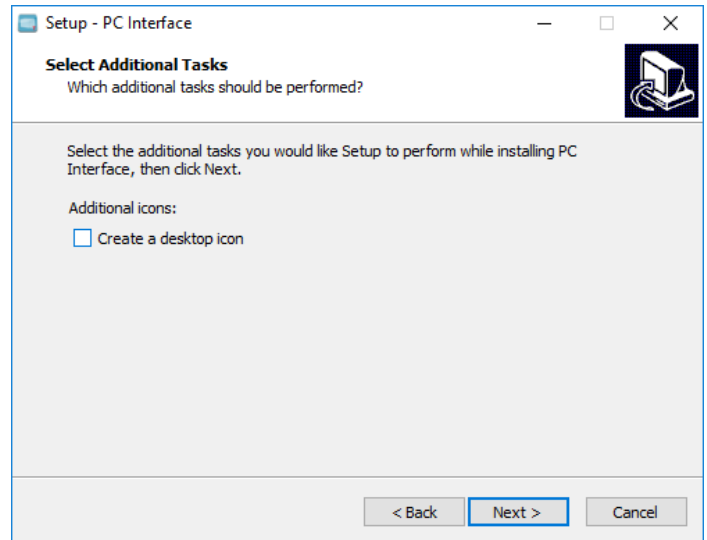

Figure 99. Additional Tasks Screen

- Allow the installation to complete. After installation is complete, it checks for the Java version 1.8 and higher in the PC. If the required Java version is not available, it installs the Java bundled with the PC Interface. If it detects Java 1.8 and higher versions, then it does not install the Java bundled with the PC Interface.
- If Java Runtime Environment is either not installed or is an older version, then the window shown in **Figure 100** will display. Application automatically starts installing the Java if the latest version of Java is not found.
- If Yes, the Java installation window displays as shown below. To verify installation location, check the Change destination folder box. Then select Install to install Java.



Figure 100. Install Java Screen

- Allow the Java installation process to complete. It may take a few minutes. The next window will open automatically.

11. After installation is complete (**Figure 101**), select Close to finish.



Figure 101. Installation complete Screen

12. After completion of installation, an application is launched which will verify the COM port for connectivity with CRF unit.

13. On clicking Verify COM Ports button, the application will start identifying the available COM ports and start establishing the connection. When Valid COM Port is found then it displays Port is Valid and PC Interface application is ready, as shown below **Figure 102**.

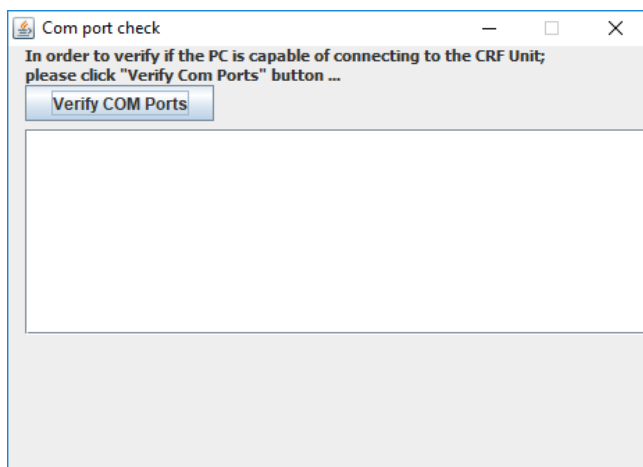

Figure 102. Verify COM Ports Screen

14. To complete the PC software installation, first check the Launch PC Interface window. Then select Finish.

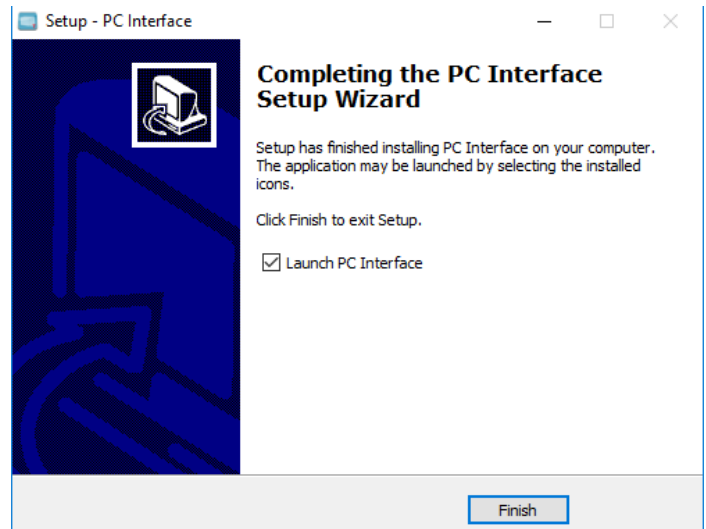

Figure 103. Launch PC Interface window

Login

The icon at right appears in the default directory after the application is successfully installed.



As the PC interface program begins, a splash screen (**Figure 104**) appears with user access to the application.

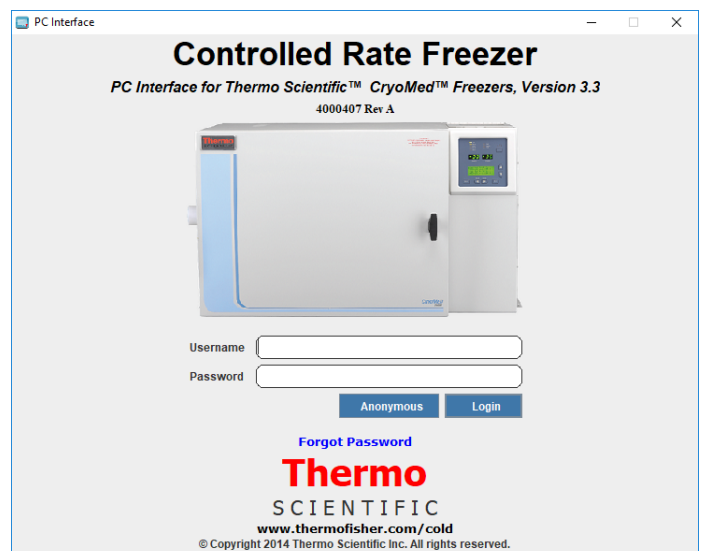

Figure 104. User Login Screen for PC Interface

Login can occur in three ways:

- **Enter User-name and Password:** If at least one user identity has already been set up, the user can login with user name and password.
- **Anonymous Login:** Access to the software is allowed without providing a user name and password, but with

limited functionality. A user can login using “Anonymous” when there are no user identities created.

- **Common Login:** A user can login to the PC software with the identity of the user name in the User name field and the static recovery password “ThermoCRF”.
- **Forgot Password:** This link enables user to reset the password when user forgets the password by way of entering correct hint question and answer.

Note: User name will be supplied with the security module of the software. 'Anonymous' is used if password security is not enabled. This will be displayed on the bottom right corner.

Requirements for user name and password are described below:

User name Requirements:

- User name length must be between 7 to 12 characters.
- User name can only start with “\$”, “_” or an alphabet, digits and special characters ('@' '\$' and '_' only) can be added after the first character.
- Password can be alphanumeric from third character onwards.
- User name cannot have spaces or linefeed.
- “Please enter User name” message displays if User name field is blank.

Password Requirements:

- Password length must be between 8 to 12 characters.
- The Password should contain combination of minimum one Uppercase (A - Z), Lowercase (a - z), Number (0 - 9) and special characters (@#\$\$%^&+=).
- The message “Please enter Password” displays if Password field is blank.
- If login information is not valid, application guides whether user-name or password entered is wrong by displaying corresponding error messages

Login Error Messages

If validation fails, corresponding error messages will be displayed as shown in **Table 10**.

Table 10. Login Error Messages

<p>This message appears when the user name length is not between 7 to 12 characters.</p>
 <p>A screenshot of a Windows-style error dialog box titled "PC Interface : Error". It features a red octagonal icon with a white 'X' on the left. The main text reads "Username should be between 7 to 12 Characters". At the bottom center is a blue "OK" button.</p>
<p>This message appears when the user name field is blank.</p>
 <p>A screenshot of a Windows-style error dialog box titled "PC Interface : Error". It features a red octagonal icon with a white 'X' on the left. The main text reads "Please enter User name". At the bottom center is a blue "OK" button.</p>
<p>This message appears when the password length is not between 8 to 12 characters.</p>
 <p>A screenshot of a Windows-style error dialog box titled "PC Interface : Error". It features a red octagonal icon with a white 'X' on the left. The main text reads "Password should be between 8 to 12 Characters". At the bottom center is a blue "OK" button.</p>
<p>This message appears when the password field is blank.</p>
 <p>A screenshot of a Windows-style error dialog box titled "PC Interface : Error". It features a red octagonal icon with a white 'X' on the left. The main text reads "Please enter Password". At the bottom center is a blue "OK" button.</p>
<p>This message appears when the user enters incorrect user name.</p>
 <p>A screenshot of a Windows-style error dialog box titled "PC Interface : Error". It features a red octagonal icon with a white 'X' on the left. The main text reads "Username is not valid, Please verify your information and try again". At the bottom center is a blue "OK" button.</p>
<p>This message appears when the user enters incorrect password.</p>
 <p>A screenshot of a Windows-style error dialog box titled "PC Interface : Error". It features a red octagonal icon with a white 'X' on the left. The main text reads "Password is not valid, Please verify your information and try again". At the bottom center is a blue "OK" button.</p>

Table 10. Login Error Messages

This message appears when the user tries to login in Anonymous with user name entered.

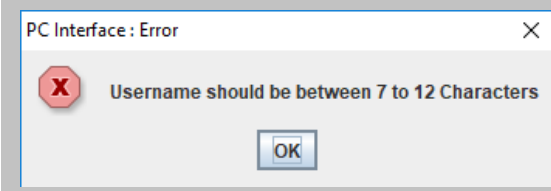
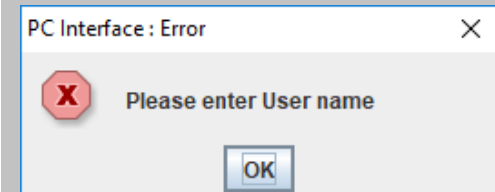
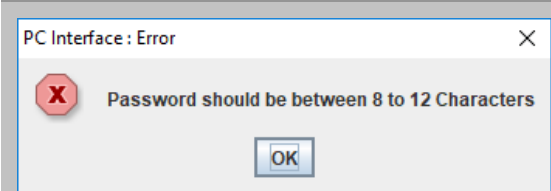
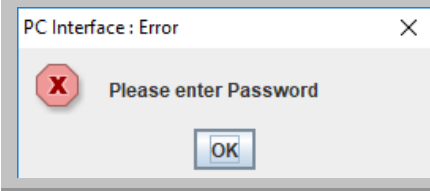
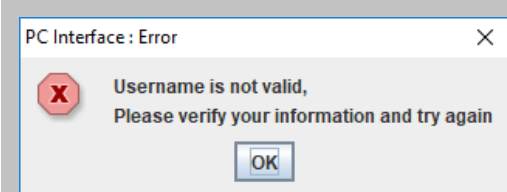
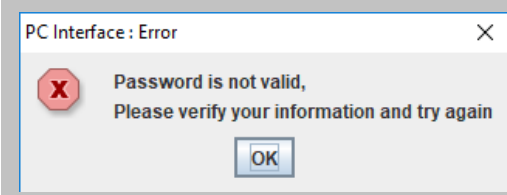
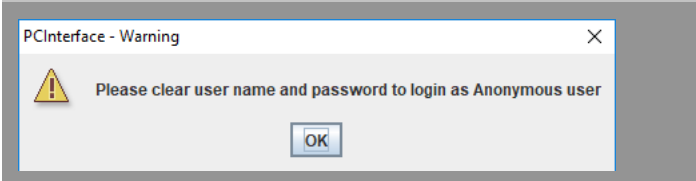

Setup

The Home Page screen opens as shown below:

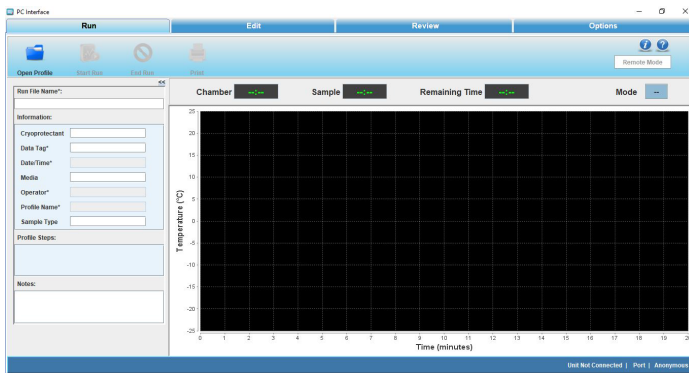

Figure 105. Home Page of PC Software

The user can perform the following functions as described.



Figure 106. Function Selections

Run Operation

Run: The Run command opens communication with the freezer through the COM port. Profile commands are downloaded and the program executed.

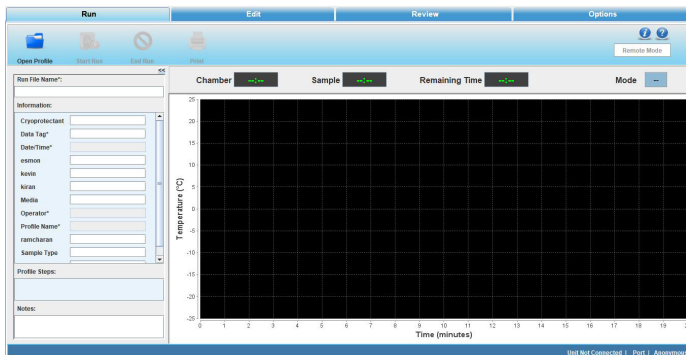

Figure 107. Run Screen

Edit: The Edit screen enables the user to create and edit a freezing profile. Users can also print a profile listing. An approximate representation of the freezing profile will be displayed in the Edit window graph.

Review: The Review screen allows a user to review the existing Run file data, or compare existing Run data. Information on alerts occurring during run are also shown.

Options: Select plot colors for a graph, set-up default directories, manage users and information fields are available user options.

The PC software continually communicates with the freezer, displaying the sample temperature and chamber temperature. Freezing Profiles are displayed in a graph. Press Ctrl + Mouse Left/Right button to pan around graph.

The Run screen enables the user to perform the following commands:

- **Open profile:** Displays the predefined and user-created freezer profiles.
- **Start Run:** Enables the user to run the freezing profile.
- **End Run:** Allows the user to end the run command.
- **Print:** Allows the user to print a freezing profile.
- **Move To:** Allows the user to move from one profile command to another. This command can be used only when the profile is running. The current step is shown in green and the moved step in yellow.
- **Manual Override:** Allows the user to change the temperature time cycle by increasing or decreasing the temperatures using cool, cool+ and warm functions.

Run File Name

Initially, the Run file name field will be empty. The user must enter a Run file name that begins with a letter. Special characters are not allowed. The length of the name cannot exceed 30 characters.

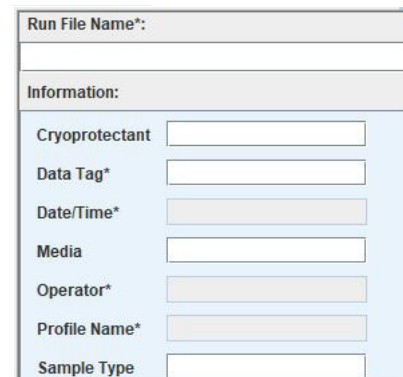

Figure 108. Run File Name

Information Fields

The Information menu contains default fields as follows:

Note: Mandatory fields are marked as *.

- **Cryoprotectant** – Enter the name of the cryoprotectant being used with the samples. The name cannot exceed 30 characters and is an optional field.
- **Data tag*** - Data tag is a mandatory data field. Information entered is used as a prefix for the file name where the run data is stored.
 - Must be alphanumeric values.
 - Special characters such as /, \, :, *, ?, <, >, | are not allowed.
 - Length must not exceed 20 characters.
- **Date/Time*** - Date/Time will be taken from the computer clock when the user initiates a run and stores run data. If the date/time changes when a profile is running, it will not affect the date/time that is stored in the run data. It will save the time Profile Steps stamp when the user runs the profile.
- **Media**- Enter information on the media being used with the samples. It is an optional field.
- **Operator*** - It is user login user name and is auto populated.
- **Profile Name*** - Indicates the profile selected (.prg file) by the user for the run.
- **Sample type** - Enter the type of sample being frozen. The description cannot exceed 20 characters.

Note: Profile Name, Date/Time, and Operator fields are not editable by user.

Profile Steps

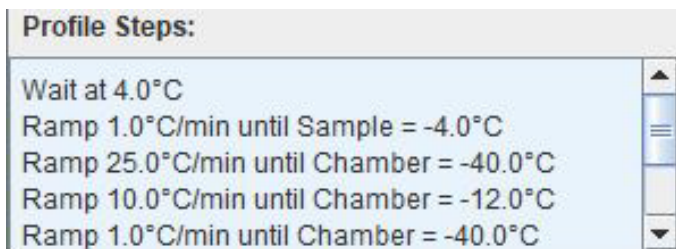

Figure 109. Profile Steps

Profile steps display all the profile commands of a freezing profile.

Notes



Figure 110. Notes

The Notes field is for additional pertinent information to be saved with the profile run date. It is an optional field and cannot exceed 1024 characters.

Chamber/Sample Temperature

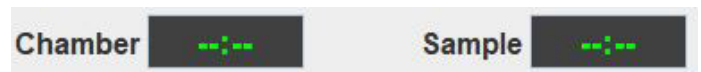

Figure 111. Temperature Display

- Shows temperature of Chamber and Sample in °C.
- Data begins to populate once the Run has initiated.

Remaining Time



Figure 112. Remaining Time

- Populates remaining time every 3 seconds once Run is initiated by the user, and when the profile achieves temperature.
- Calculates the remaining time from the second profile step, after the WAIT step.
- Calculates the time only for profiles having ramp and hold steps.
- Does not calculate during manual override, move to, loop and jump functions.
- Displays time in minutes and seconds.

Mode



Figure 113. Mode

- Mode displays the current state of the freezer, displays warm if unit is warm.
- Idle indicates the unit is in Idle state.
- Wait indicates unit is in Wait state.
- Changes to Run after run is initiated.
- Shows End if program is complete.

Remote Mode



Figure 114. Remote Mode

- Remote Mode is used to indicate if the CRF is under control of the PC software.
- Initially, the remote mode is displayed in a white color.
- This field turns green when successful connection to the freezer has occurred, and the freezer is remotely controlled.

Graph

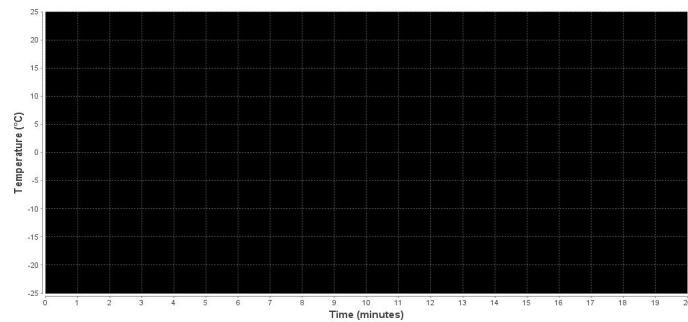

Figure 115. Graph

- A graph displays the run profile as it progresses.
- X-axis displays time in Minutes. Default setting for X-axis is 1 minute.
- Y-axis displays temperature in degrees Celsius (°C). Default setting for Y-axis is 5°C.

- Allows the user to zoom in and out. Graph is adjusted based on the temperature selected. Press Ctrl + Mouse Left/Right button to pan around graph.

Graph Legend

The Graph Legend displays the different plot colors at upper right side of the graph for Review and at bottom side of the graph for Run.

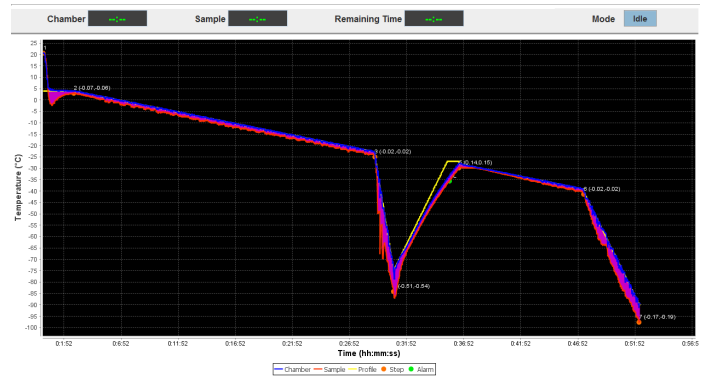

Figure 116. Graph Legend (Run Graph)

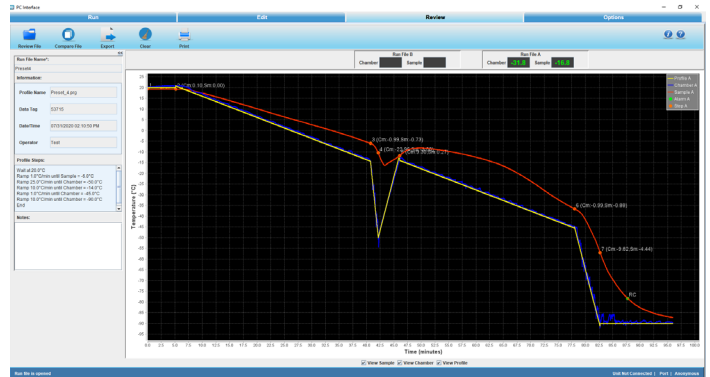

Figure 117. Graph Legend (Review Graph)

The legend shows the key colors and symbols used to represent:

- Chamber Plot
- Sample Plot
- Profile Temperature Plot
- Step Marker with Chamber and Sample temp/time slope
- Alarm Marker

Note: Chamber and Sample Temp/time slope values are shown as (X, Y) beside to the step marker where “X” refer to Chamber slope and “Y” refer to Sample slope.

Typical Run Procedure

1. Click Open Profile. The Open window appears.
2. Select the required profile.
3. Click Open. The freezer profile is displayed.
4. Enter the Run File Name and Data Tag field.
5. The sample temperature, chamber temperature, and the profile temperature are received from the CRF unit every second.
6. Before the profile run begins, the user will be prompted to select the COM port, from a list of available COM ports, to which the CRF has to be connected. The ports which are not available at that time will be inactive (hidden). The COM port Selection window is shown below

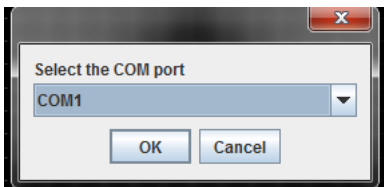

Figure 118. Select Port

7. Click OK. A window appears displaying “Click OK to start profile download”.

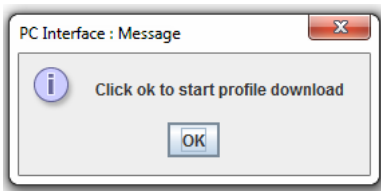

Figure 119. Downloading

8. Click OK. A window appears displaying “Profile is downloaded.”

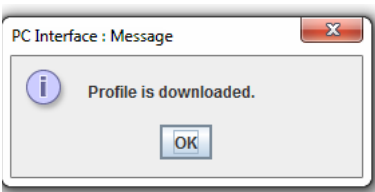

Figure 120. Downloaded

9. Click OK. A Save window appears.
10. Saves automatically in the default directory. Select the path of the directory and ensure that the file type is .RUN.

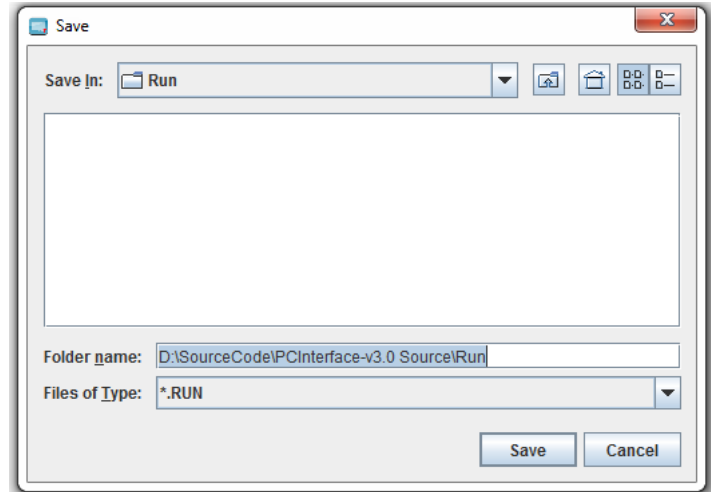

Figure 121. Save

When “Save” dialogue box pops up, it is recommended to browse to your desired directory or type in the full path (case sensitive). Network drives are prone to connection failure which could cause data loss during profile Run data storage. It is recommended to use a local drive to store profile Run data.

11. Click Save. The profile is saved in the directory selected.
12. Program waiting for user- click here to continue will appear on the graph. This message will be displayed to the user when the freezer is in wait step while in the remote mode. Select this message in order to begin profile run. The message will not pop-up when freezer is in the standalone or normal mode. When the user clicks “Click here to continue” the application will send a run (22 decimal) command to the freezer that causes the freezer to move to the next step in the profile.

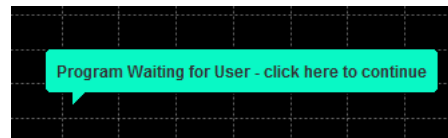

Figure 122. Continue

13. Remote Mode button will turn green color once Profile run is started.



Figure 123. Green Remote Profile Button

14. Remaining time will display in green color once Profile run starts.
15. Current run step will be highlighted in the Profile steps in green color.
16. While running profile - Run file name will be displayed at left corner of the status bar. Unit Connected, Com Port

number and User name will be displayed on the Right corner of the status bar.

- 17. The Print option allows the user to preview and print a profile. It will use Windows default print dialog.
- 18. Click Move To to change from one profile step to another.
Note: Do not remove Serial port during Unit Operation, if removed application closes by itself when PC doesn't have a dedicated serial port.
- 19. The following are the errors that may occur while running a profile:

a. **Error Messages**

- i. **Communication Failure, Freezer not responding:**
The freezer is not sending status updates to the PC on request. Verify that the communication cable is connected and working properly, the freezer has power and is turned on, and that there is not a hardware failure in the PC or freezer. If communication is interrupted for more than 20 seconds, the freezer will go into 'Off-line' mode.

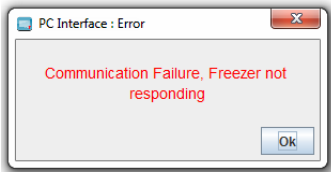

Figure 124. Communication Failure Error

- ii. **Freezer Already In Use:** This message appears when a communication port is selected for a freezer that is running a profile initiated from the freezer UI. In this case, the PC cannot take control. Select the 'Terminate Session' button to close the Run window.

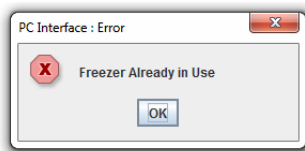

Figure 125. Already In Use Error

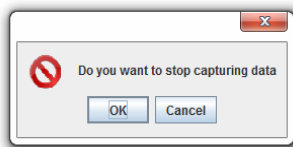

Figure 126. Cannot Stop Error

- iii. **Cannot Stop Freezer in Stand-alone Mode:** This message displays if the Stop button is clicked while the freezer is running a Remote profile in 'Stand-alone' mode. Clicking the Stop button at this time stops only the data capture. Choose 'Continue

capturing data' or 'Stop capturing data'. No other commands can be sent from the PC.

- iv. **Program loading error:** The download program cannot be validated: This message appears after the download profile fails to validate (initial validation and three re-tries).The user must open a profile again and initiate the run.
- v. **Communication error-** A CRF was not found: This message appears when the user opens a run screen and selects a COM port that is not connected to a freezer. The user has to select the other COM port to start/initiate the run.
- vi. **Serial Port error** - COM port is busy or unavailable: This message appears when the user opens a run screen and selects COM port that is in use with another application. This message will be displayed when the user attempts to open a Run screen when all available COM ports are already communicating with freezers and/or when the maximum of two Run screens are already open.
- vii. **'ILL' error** in chamber and sample temperature: This error appears when the profile (.prg file) created is delimited by comma (,) instead of dot (.) due to regional setting of the PC. The user is advised to change the regional setting to English (United States) to resolve this issue.

Manual Override Procedure

Manual Override allows the user to change the temperature time cycle while running a freezer profile defined in the profile Steps. Manual Override prompts the user for a password. Manual override toggle buttons are activated by pressing the mouse button on the respective function button.

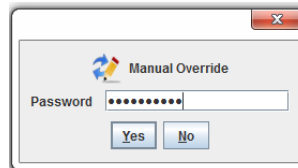

Figure 127. Override Password



Figure 128. Manual Override Buttons

- 1. Manual Override button function will remain Active for 5 seconds after it is released.

- If the User presses another button within 5 seconds i.e. when other button function is active, then the latest button function will be activated and previous button functionality will be stopped immediately.
- Manual Override Buttons are available only during Run Mode.

The manual override displays three modes of temperature variation:

- Cool:** The override Cool button energizes one solenoid.
- Cool+:** The override Cool+ button energizes both solenoids.
- Warm:** The override Warm button turns the heater ON.

End Run

End run allows the user to end the run of a freezer profile. This option is enabled only while profile is in Run mode. User will be prompted to enter a correct password to end the profile. Note that these pop-up windows may appear behind the software screen if user is running multiple programs at one time. Minimize software, and pop-up will appear.

- Click End Run. A window appears to confirm the end of run.

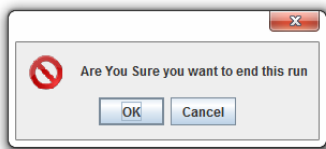

Figure 129. Stop Run

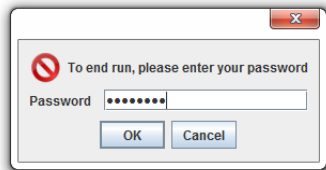

Figure 130. Password to End Run

- Click OK. A window appears to enter a password. The user must enter a password to confirm end run.

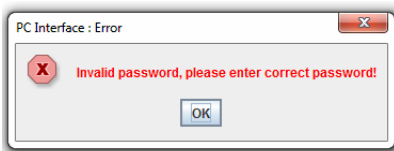

Figure 131. Password Invalid

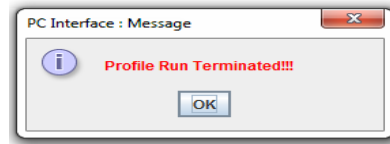

Figure 132. Run Terminated

- Displays a pop-up window if an incorrect password is entered.
- Click OK and enter the correct password to terminate a profile run. A window appears showing “Profile run terminated”. Click OK to close.
 - Remote Mode button will turn white after profile run is terminated.
 - Unit Connection status will turn to Unit Not connected in footer panel.
 - Manual Override button will be disabled.
 - CRF will stop running the profile.
- After the profile run is complete, the profile Run Completed window will appear as shown in **Figure 133**. Press Ok in pop-up window.

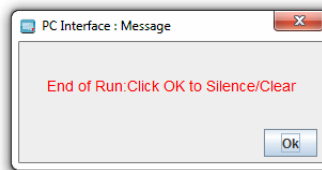

Figure 133. Completed

- Press the End Run button from the window bar. This will terminate the profile.
- To warm the chamber to room temperature, select and run preset profile #7 (preset_warming). This profile will return the chamber to a temperature of 25°C.

Print

Print allows the user to print a freezing profile in three categories: Profile Header, Profile Data and Graph Data

User can also print freezing profiles in three formats: With graph and slope, with graph and no slope and no graph

Page 1:

Header - Controlled Rate Freeze Run Data Report

Profile Data contains:

- “Program” profile name with directory details
- “Author” Operator name

- “Edited” profile created date as edited date
- “Printed” date and time of profile printout taken
- “Data tag” entered in the profile
- “Media and Sample type” values taken from the run screen
- Custom fields if added any
- “Description” entered notes as description
- Page numbers at bottom left corner of print document
- “Thermo Scientific” logo at bottom right corner of print document.

Page 2:

“Printed on” as header

Profile Data contains:

- “-----” as sub header
- Profile commands with numbering
- “Alarm Listing” as header
- “-----” as sub header
- “Occurrence “Alarm Profile Time (min) as header
 - Alarms occurrence details with alarm type and time of occurrence
- Page numbers at bottom left corner of print document
- “Thermo Scientific” logo at bottom right corner of print document

Page 3 contains Profile Graph:

- “Printed” date and time of profile printout taken as Header
- Current view of the profile run graph
- Page number at bottom left corner of print document
- “Thermo Scientific” logo at bottom right corner of print document.

Alarms

When an alarm condition occurs, audible and visual alarms are presented at the freezer, and an alarm window appears on the PC screen. The window contains a list of up to three of the most recent alarms and the message ‘Click Here To Silence’ displays. Note that these pop-up windows may appear behind the software screen if user is running multiple programs at one time. Minimize software, and pop-up will appear.

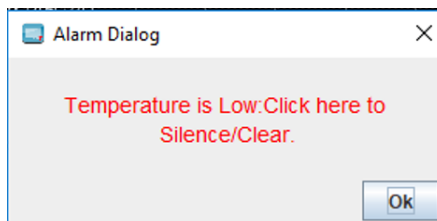

Figure 134. Click to Silence

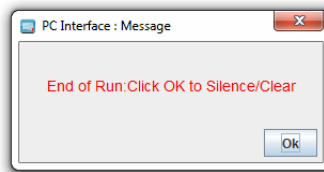

Figure 135. Clear Alarm

Click anywhere on the alarm window to silence the audible alarm at the freezer. After the audible alarm is silenced, another alarm window appears showing the list of three most recent alarms and the message ‘Click Here To Clear’. Click anywhere on the alarm window to clear all alarms that have been resolved. The alarm window reappears if any alarms are still active.

If the message ‘Profile Stopped At Freezer’ displays, the run has been stopped due to a component failure in the freezer or when a user selects the Back button at the freezer during the end run of the profile. Click the message to acknowledge that the run has stopped. This action has the same effect as the Stop button.

Alarm messages alert the user to the alarm status of the freezer. The user must clear the message on the screen even though the alarm condition may have already corrected itself. Alarm messages may also appear before or during a run. Alarm messages alternate if multiple alarms are present one at a time.

Alarms are cleared with the Silence key. Graph shows multiple tracking alarms once the occurred alarm has been cleared.

The following are the alarm messages that could appear:

- **“Temperature is High: Click OK to Silence”** message appears when chamber temperature is greater than programmed temperature by a pre-determined amount (5°C).
- **“Temperature is Low: Click OK to Silence”** message appears when chamber temperature is less than programmed temperature by a pre-determined amount (5°C).
- **“Chamber Sensor fail!”** message appears when chamber temp >75.0°C.
- **“Sample Sensor fail!”** message appears when sample temp >75.0°C.

Power Failure Recovery

If the Controlled-Rate Freezer experiences a power failure and the PC continues to operate:

The freezer continues to run the profile from the point of failure when the power is restored. However, the freezer runs in 'Stand-alone' mode. All commands from the PC are ignored except for profile status requests. The temperature data is continually captured and plotted. The PC cannot clear alarms or stop the Run. The UI of the freezer remains disabled.

The Run can be aborted at the freezer by pressing the Abort button in the remote dialog box. The freezer resumes the controller on the unit.

The Stop button on the Run screen ends data capture only. The PC will report a Power Fail alarm including the failure duration, if the failure duration is longer than 10 seconds. A communication error message will display on the Run screen during the freezer power failure.

If the PC experiences a power failure and the Controlled-Rate Freezer continues to operate:

When power is restored to the PC and Windows reboots, restart the freezer application.

Select Run from Main Menu. Select any profile, fill mandatory fields (Data Tag and Run file name) and press Start Run. Choose the COM port for the freezer that is running. A pop-up message appears as shown in **Figure 136** and PC will recover the Run data captured prior to its power failure, continue Run in 'Stand-alone' mode. The graph on the Run screen will show the gap when the PC was not communicating. Graph plots the data before power failure and continue to show the plotting of the continuous stream of data from CRF there after.

Note: If PC power failure occurs during wait step and CRF goes to standalone mode, CRF doesn't get past the wait step.

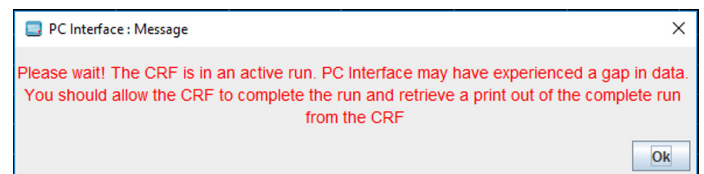

Figure 137. PC Power failure Recovery

Two Run screens can be restored for freezers that were running during the PC power failure. Graph shows PCPF and PCPR icon during power failure and power resume.

- “**Chamber temp limit**” message appears when chamber temperature is in between 55°C to 75°C or less than -185°C.
- “**Sample temp limit**” message appears when sample temperature is in between 55°C to 75°C or less than -185°C.
- “**Warm Complete**” message occurs five minutes after the chamber reaches 25°C during a warm cycle.
- “**End of run: Click OK to Clear**” message appears five minutes after the end profile step is reached.
- “**Check LN₂ Supply!**” message appears when LN₂ is ON for 30 minutes.
- “**Heater Error**” message appears if the heater is energized continuously (no active temperature control) for 60minutes.
- “**Printer Buffer Full!**” message appears when the printer storage buffer is full of run data (approximately 2 hours) and no longer able to store the data for later printing.
- **Power failure at CRF!**
 - “Power Failure” message appears when there is a power failure in freezer.
 - The computer reports a Power Fail alarm and the failure duration, if the failure duration is longer than 10 seconds.
 - The graph on the Run screen stops plotting when there is a power failure and user will be prompted if failure duration is more than 10 seconds.
 - If CRF experiences multiple Power Failures, the graph on the run screen will show multiple Power Failure alarms once the occurred alarm has been cleared.

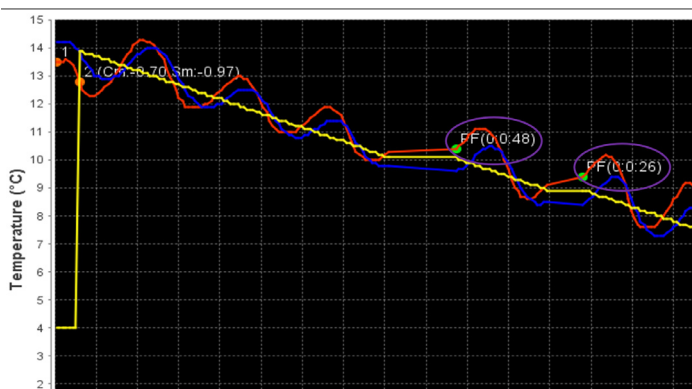

Figure 136. Power Failure

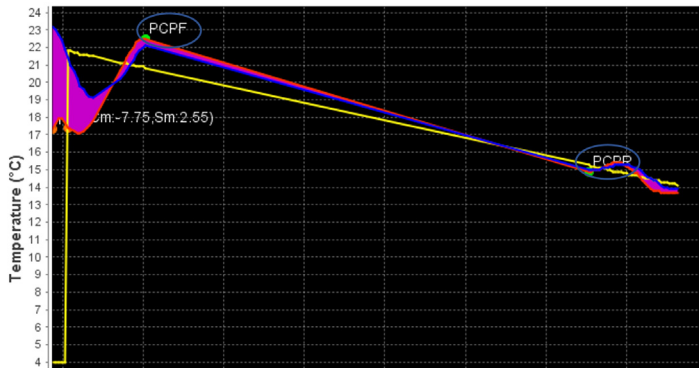

Figure 138. PC Power failure and Power resume

Display/Control Summary

Controlled-Rate Freezer and PC configuration has three types of modes: Remote Mode, Stand Alone Mode, and Running a Local Profile.

Remote Mode

The PC can initiate all actions at the freezer such as Run, Stop, Warm, Manual Over-ride, Alarm Silence, and Alarm Clear. The PC displays the current freezer operation status (Idle, Run, Wait, End, and Warm) for the chamber and sample temperatures. Time and temperature details are captured every 6 seconds.

The CRF UI is disabled except for a remote dialog box which can be used to end remote control and end the current run. Alarm messages on the PC must be cleared by the user.

Stand Alone Mode

The PC can only capture time/temperature and alarm data in this mode. No action commands are permitted. Current operating status and chamber/sample temperatures will be updated and displayed normally.

The UI is still disabled in this mode except for the remote dialog. However, a run may be aborted by pressing the abort button on the remote dialog. All freezer status and temperature displays operate normally.

Edit Screen

The edit screen enables the user to create a freezing profile or edit an existing freezing profile. The user can also print a freezing profile.

Edit Policy:

- **Wait Command Range:** Temperature values must be between 50°C to -180°C.
- **Wait For Temperature Command Range:** Temperature values must be between 50°C to -180°C.

- **Wait For Temperature Command:** Sample Temperature value must be min 1°C greater than Chamber Temperature value.
- **Ramp Command Range:** The rate of freezing must be between +0.1°C to +99.9°C and temperature values must be between -180°C to +50°C.
- **Hold Command:** Allows the user to enter a temperature range between 50°C to -180°C.

The edit screen is shown below. Press Ctrl + Mouse Left/ Right button to pan around graph.

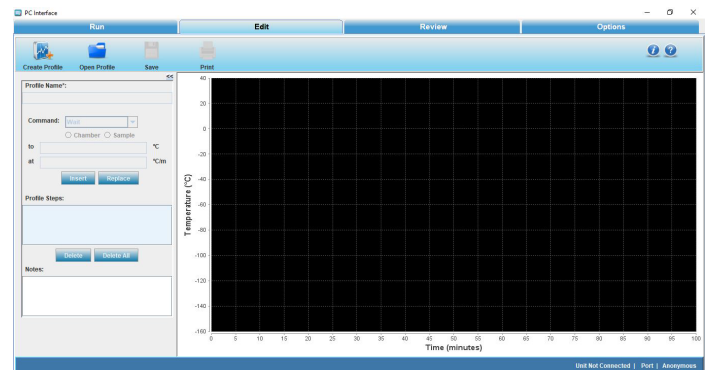

Figure 139. Edit Screen

Startup

- Create Profile enables the user to create a freezer profile. The user must enter the profile name, select the command from the drop down menu and insert the profile steps.
- Open Profile enables the user to edit an existing profile. The information fields are auto populated when the user opens an existing profile and enables the user to modify the required fields.
- Save enables the user to save the profile created or save any modifications performed on a profile and save it as a new file. User is prompted to save with a different file name.
- Print enables the user to preview and print a freezer profile. It also allows the user to select a printer, set printer properties, select a preview function, specify the no. of copies, print style, etc.
- The graph is plotted based on the steps added/edited in the profile.

End step follows automatically when you insert any profile command.

The following profile steps will be available in the drop-down menu:

Wait:

WAIT AT X.X°C SET TEMPERATURE.

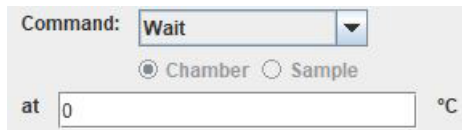

Figure 140. Wait Command

Maintains specified chamber temperature indefinitely until the user clicks the “Program waiting for user -- Click here to continue” button on the Run screen. The temperature can be set over the -180°C to +50°C range, with a setting resolution of 0.1°C.

Wait For:

WAIT AT CHAMBER=X.X°C UNTIL SAMPLE=Y.Y°C.

- X.X is Chamber set temperature and Y.Y is the Sample trip temperature.
- The default Sample trip temperature is 1°C above Chamber temperature.

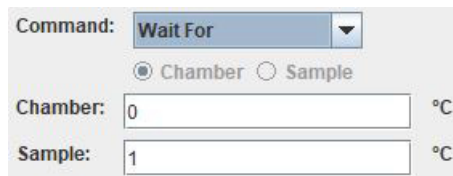

Figure 141. Wait For Command

Step maintains specified Chamber temperature and moves to next step in profile when Sample temperature cools to the specified temperature. This step should be used when the starting Sample temperature is greater than the specified Sample temperature (the Sample is cooling).

IMPORTANT: Step 1 only permits a Wait or Wait For as command.

Ramp:

RAMP X.X°C/MIN UNTIL CHAMBER=Y.Y°C (or) RAMP X.X°C/MIN UNTIL SAMPLE=Y.Y°C.

- X.X is the ramp rate and Y.Y is the chamber (or sample) endpoint temperature.

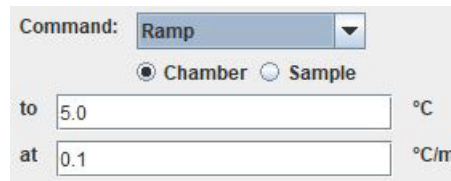

Figure 142. Ramp Command

This step changes Chamber temperature from its current value to specified temperature (chamber sensor trip point) at the selected rate (°C/minute). The rate can be set over a range of 0.1°C/ minute to 99.9°C/minute. The temperature can be set over a range of -180°C to +50°C (±0.1°C). When the chamber reaches specified temperature, the control moves to the next step in the profile. If Sample is selected, chamber temperature changes at a specified rate until sample reaches specified temperature.

Note: The slope of the temperature ramp is determined automatically, based on the temperature defined and the chamber temperature at the beginning of the step. Entry of a sign (+/-) for the temperature ramp rate term is not allowed.

Hold:

HOLD X.X°C FOR Y.Y MINUTES.

- X.X is the chamber set temperature and Y.Y is the minutes.



Figure 143. Hold Command

Maintains a specified Chamber temperature for the specified hold duration before proceeding to the next step. The time can be set over a range of 1 to 99 minutes, and the temperature can be set over a range of -180°C to +50°C with a setting resolution of 0.1°C.

Note: Chamber and Sample selection are deactivated here.

Jump To:

JUMP TO STEP X.

- X is the step number.



Figure 144. Jump Command

Automatically advances to a subsequent step or returns to a previous step in a freezing profile. The Jump function can be programmed over a range of Step 1 to END Step.

Note: Chamber and Sample selection are deactivated here.

Loop:

LOOP X TIMES STARTING AT STEP Y.

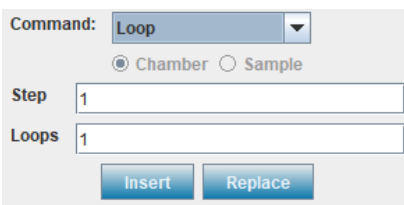

Figure 145. Loop Command

X is number of repetitions and Y is the step number to begin. Automatically advances to a subsequent step or returns to a previous step in a freezing profile for a programmable number of repetitions. The Loop function can be programmed from Step 1 to END Step, and over a range of repetitions from 1 to 99.

1. Click **Insert**. The temperature of the chamber is defined.
2. Click **Replace** to replace the temperature of the step.
3. The defined commands and temperatures are displayed in Profile Steps.
4. Click **Delete** if the user wants to delete a profile step.

Note: The user can add notes in the Notes section, if desired.

Create Profile

Create Profile enables the user to create a custom freeze profile for the CRF based on the user's requirements to preserve the test samples in the CRF based on the user's requirement. The following image shows the Create Profile screen:

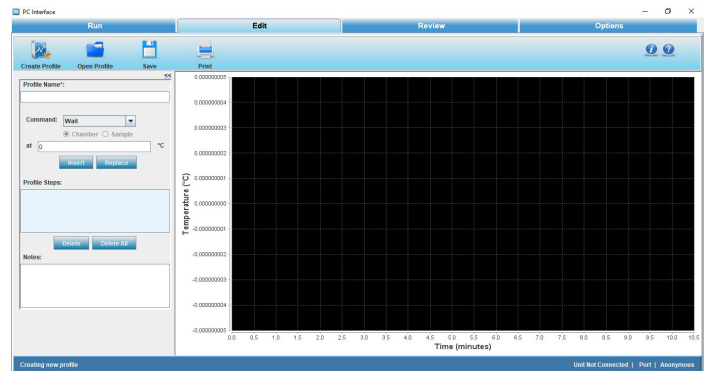

Figure 146. Create Profile Screen

To create a freezing profile, follow these steps:

1. Enter the Profile Name.
2. Select Wait or Wait For from the Command drop down. As first step can be either wait/wait for, hence it cannot be created automatically for every run.

Wait or wait for command increases the TEMPERATURE of LN₂ and is the mandatory first step. It is required to purge the warm LN₂ plumbing prior to initiating controlled rate freezing. This step is not available for deleting or changing to a different step type.
3. If the user selects WAIT command, the CRF (chamber) waits at 0°C or at user defined temperature. If the user selects WAIT FOR command, the chamber temperature waits at 0°C until sample temperature is 1°C.
4. Select the desired profile steps from the command drop down. The commands selected are displayed in the profile steps.
5. **Insert** is used to add a step. The new step will be added on the line that is highlighted. **Replace** is used to modify an existing step's parameters or change to a different step type and **Delete** is used to delete a step and **Delete All** is used to delete all steps at a time.
6. **END** is the mandatory last step. It alerts the freezer that the profile steps are completed. This step is automatically added during the profile creation. It cannot be deleted or replaced.
7. Click **Save** to save the custom profile. Notes are saved with the profile and are printed with the run data. Saved profiles are given the extension ".prg". If the profile already exists, then the software prompts the user to confirm whether to replace the profile or not.

Note: There can be a maximum of 20 steps, including the End step.
8. The temperature range for all the profile steps while creating a profile is -180°C to 50°C. Ramp rate has a range of 0.1°C/minute to 99.9°C/minute i.e. 0.1 ≤ Ramp Rate ≤ 99.9°C/minute.

- Ramp rate field can take fractional values but temperature, if set in fractions, will be rounded off to nearest integer.
- The graph is plotted based on the steps created.

Edit Profile

The edit profile enables the user to modify a freezer profile. The user can insert a new step, change the step type, modify the step parameters or delete one or more steps. Press Ctrl + Mouse Left/Right button to pan around graph.

To edit a profile, follow these steps:

- Click **Open Profile**. A dialog box with title “CRF PC Companion: Open” is displayed which allows only .prg file to be selected. The steps appear in the program listing window and the graph is also displayed.

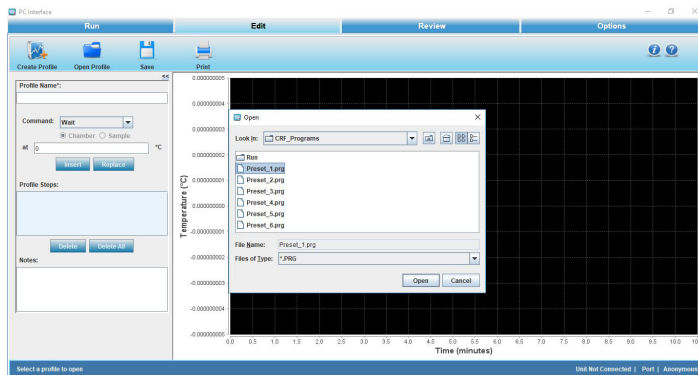

Figure 147. Open Profile

- Select the profile and click Open. The freezing profile opens.

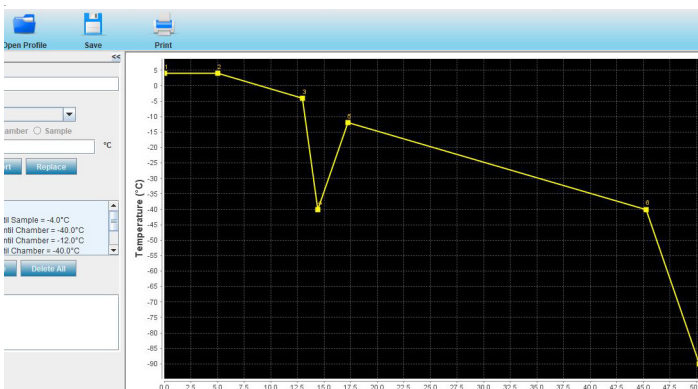

Figure 148. Freezer Profile

- Insert** button is used to insert the new step. Initially it is nonoperational.
- Replace** button is used to modify or edit a step. Initially replace is non-operational.
- Delete** button is used to delete a step.

- Delete All** button is used to delete all steps of a profile. When the user clicks the Delete All button, a confirmation window is displayed as shown below.

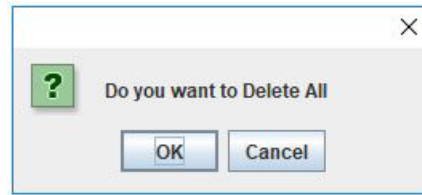

Figure 149. Delete all Confirmation

- New steps will be inserted at the position highlighted in the program listing window.
- Subsequent steps will move down one position as new ones are added.
- Selecting the step type and entering the desired parameter option will be available for the user.
- The graph will be modified accordingly with the changes in the steps.
- The user can save the profile edited. The same file name may be used or a new profile name can be entered. Optional notes may be saved with the profile. Notes will be printed with the Run data.
- Make the required changes and Click Save. A Save window opens.

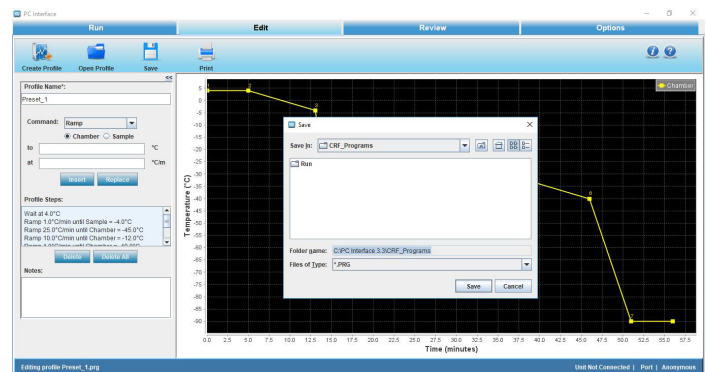

Figure 150. Save Edited Profile

- Click Save. The modified changes of the profile step are saved.

Print a Profile Listing

Print profile listing enables the user to preview and print the freezing profiles. The user can select the printer, set printer properties, specify the number of copies, and print style. Print policies are as below:

- Profile Header is bold in print.
- Print contains “Program:” and Profile name.

- Print contains the “Author:” and Operator name.
- Print contains “Edited:” and Profile created date as Edited date.
- Print contains “Printed:” and Date and Time of Printed as Printed.
- Print contains “Description” and entered notes as description.
- Print contains “-----” as sub header.
- Print contains “Program Listing:” as header.
- Print contains Profile commands with numbering.

Display Profile Temperature Graph

A representation of the freezing profile is displayed on the Edit window graph. Refer to the following illustration.



Figure 151. Graph of Freezing Profile

The starting point of each Step is indicated on the graph line by a small shaded square.

To view a specific location on the graph, point at cursor, press and hold the left mouse button, and drag the cursor to the desired graph position.

1. Axis:
 - i.) X-Axis will be displayed as Minutes.
 - ii.) Y- Axis will be displayed as temperature (°C).

Error Messages

Description of error messages that occur during an edit profile are as follows:

Note: All the fields that are not relevant to current running step will be disabled. For example, if a loop operation is

running, then the steps related to Wait, Wait for etc. will be disabled.

Table 11. Error Messages



Error Message	Description
When the user tries to replace the first step	
“Can’t replace first step”	This message appears if the user tries to replace the first step in the profile with a Ramp, Hold, Jump, or Loop Step.
	
“Graph step transition capacity exceeded”	This message appears when the step transition capacity of the graph is exceeded. This will alert the user of an unintentional infinite loop, but allows the user to continue the edit/save process normally if the infinite loop is intentional.
The user selects Enter or Replace when the selected step parameters are out of range	
“Invalid Chamber/ Sample value entered. Value must be between +50°C and -180°C”	This message appears when the temperature is outside range of -180°C to +50°C (Wait, Wait For, Hold, Ramp).
	
“Invalid Ramp value entered. Ramp rate must be between 0.1 and 99.9°C/m”	This message appears when the temperature rate is outside the range of +0.1°C/min to +99.9°C/m (Ramp).
	

Table 11. Error Messages

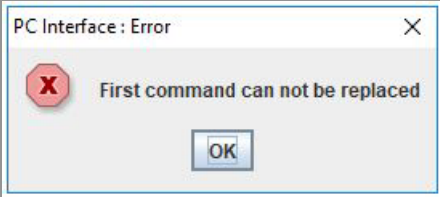
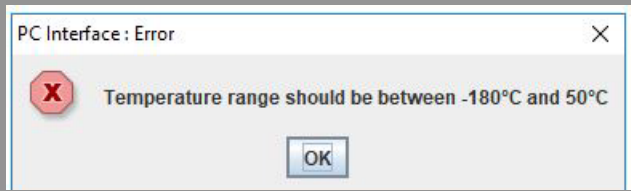

Error Message	Description
“Invalid Sample temperature value entered. Value must be greater than the Chamber temperature and should be whole number”	This message appears when the sample temperature is not greater than the chamber temperature (Wait for).
	
“Invalid Step Number”	This message appears when the user enters the invalid step number or greater than the current number of steps (Jump, Loop).
	
The user selects Enter or Replace when the selected step parameters are out of range (continued)	
“Select the valid Value”	This message appears when the number of repetitions is outside the range of 1 to 99.
	
When the user tries to save a profile with an already existing name	
“File already exists”	This message appears when the user is trying to save a profile with an already existing name.
	
When the user tries to give the time value outside of the range 1 to 99 minutes in Hold Command	

Table 11. Error Messages

Error Message	Description
Invalid time value is entered. Time value must be between 1 and 99 minutes	This message appears when the time value is outside the range of 1 to 99.
	
User edits any profile and without saving the changes moves to other tabs	
This warning message appears when user moves to other tabs without saving the changes.	
	
This error message appears when Profile open Operation cancelled by user.	
	
This error message is shown when user tries to delete any step from the profile which contains Jump as one of the profile step.	
	
This warning message shown when user tries to add the Jump Step.	
	

Review Screen

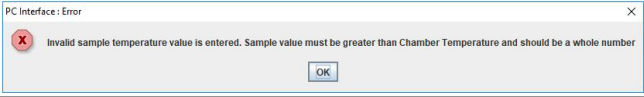
Review enables the user to perform the following functions:

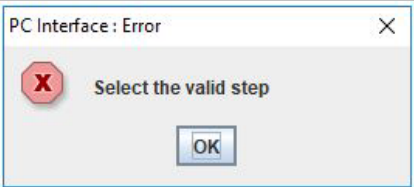
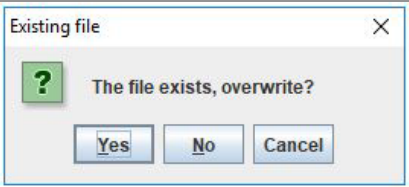
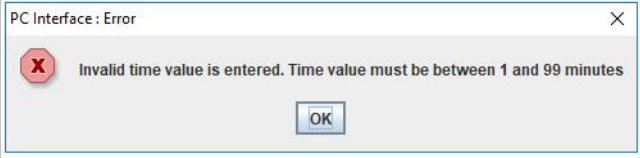
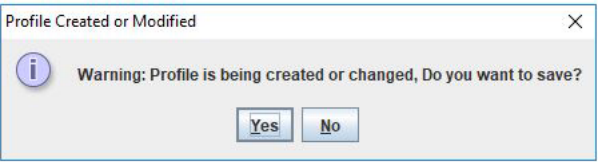
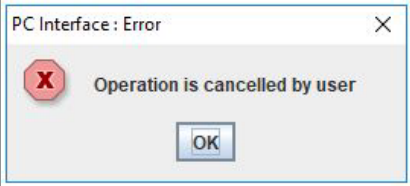
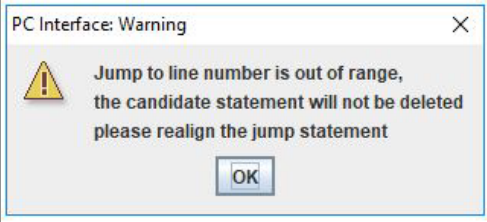
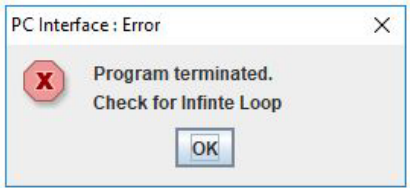
- Review a run profile
- Compare two run profiles
- Export the file in a .CSV format
- Print a profile

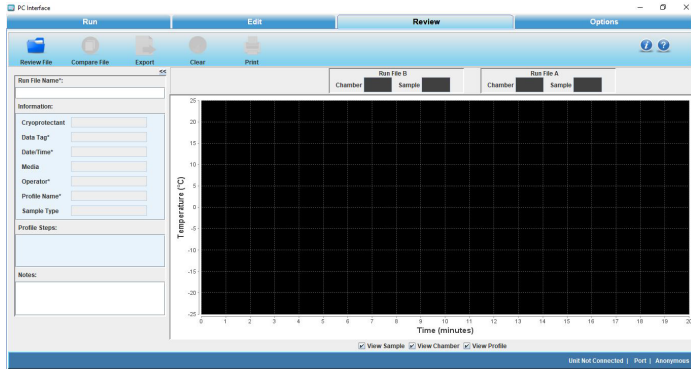

Figure 152. Review Screen

In Review, a user can review, analyze, and compare run data from “.run” files. A user can also open “.run” files from the previous software version. Review will not change run data in any way, i.e. it will not make any changes in “.run” files. Hence, all the fields will be grayed indicating that they are not editable. Review allows a user to open and plot run data i.e. Chamber, Sample (actual performance of the unit), and profile plot.

A user can review .run files from the previous version software as well. Review will be able to provide plot chamber/sample/profile data Review File. The graph fits automatically irrespective of the scale of the graph plot.

The screen shown in the figure below will appear once the user clicks Open and selects the required run file. Press Ctrl + Mouse Left/Right button to pan around graph.

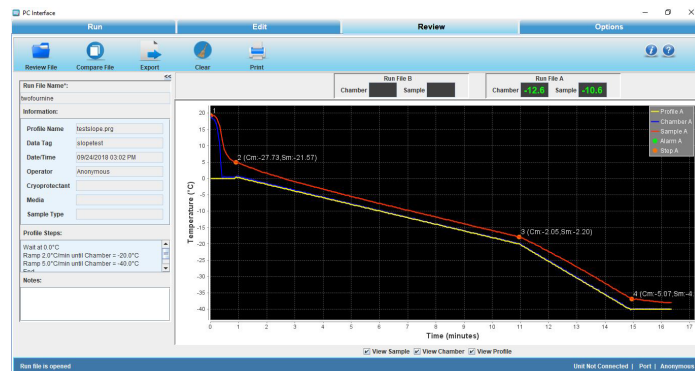

Figure 153. Review Profile Screen

User Controls

- **Review:** This screen enables the user to review a freezer profile. When the user opens a run file to review, the properties of a freezer profile are populated automatically.

Note: A current running profile cannot be used for comparison until it has ended. A run file will be reviewed or compared only after its corresponding run has completed.

- **Compare:** This screen allows the user to compare two run profiles. The profiles are named as Run File A and Run File B. The user can compare information fields, profile steps, analyze the graph plots of two profiles and the chamber and sample temperatures respectively.

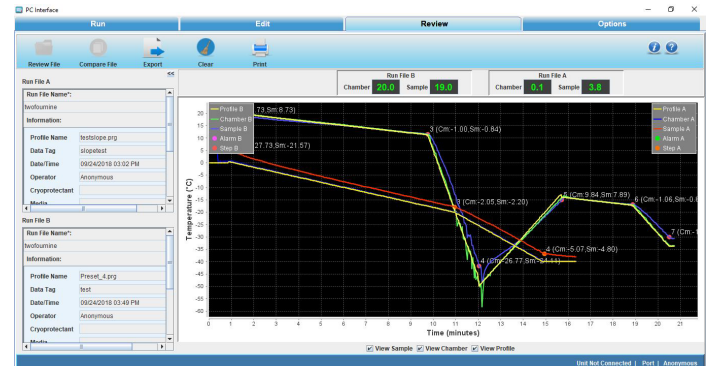

Figure 154. Compare Profiles

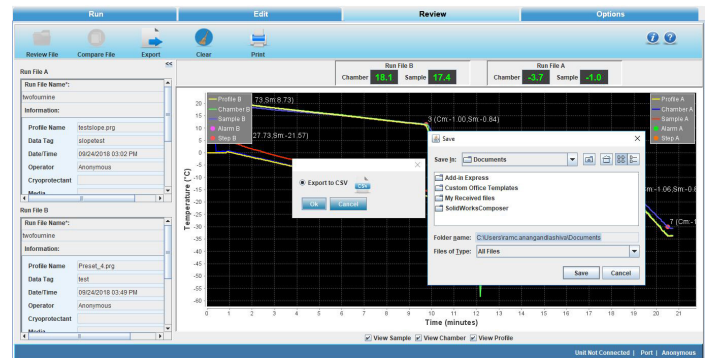

Figure 155. Export

If user tries to open/compare a running profile below error message appears.

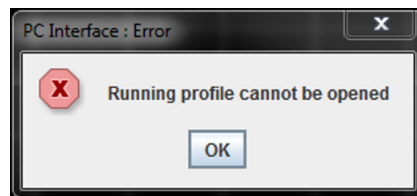

Figure 156. Error Message

- **Export:** The export icon allows the user to export the file into the local system in the .CSV format.

The user must select the destination folder to export the file. A “.csv” file contains the following information:

- Company name
- Data tag entered by the user
- Date and time of profile run
- User name
- Sample type and Media entered by user
- Custom fields if any added by user
- Notes entered by the user
- Run file name
- Profile name
- Profile steps
- Elapsed time, chamber temperature, sample temperature and profile temperature
- Occurrence of alarm time with alarm information
- **Clear:** Clear allows the user to clear all the information fields of a run profile.
- **Print:** The user can preview and print the review run file information and the run files compared using the print icon. It allows the user to select a printer, set printer properties, select a preview function, specify the no. of copies, print style, a pop-up to print with and without graph etc.

‘Single Page Report’ may be selected to print the current review screen. A ‘Two Page Report’ may be chosen to print, in addition to the current view of the graph, one or two information sheets. The first sheet printed on a two page report is the open Review file information.

Print Report:

Compare data print is a 5 page report:

Page 1 contains:

- “Printed” date and time, Controlled-Rate Freezer review compare data report as header
- First “Program” profile name with directory details
- First run file name
- Date and time of profile executed
- Information fields – Cryoprotectant, media, sample type, custom fields, Notes entered by user
- Page number and Thermo Scientific logo

Page 2 contains:

- “Printed” date and time as header
- Profile steps
- Alarms occurrence and its information

- Page number and Thermo Scientific logo

Page 3 contains:

- “Printed” date and time, Controlled-Rate Freezer review compare data report as header
- Second program name with Directory
- Second run file name
- Information fields – Cryoprotectant, Sample type Media, Custom fields if any and the Notes entered by User
- Page number and Thermo Scientific logo

Page 4 contains:

- “Printed” date and time as header
- Profile steps of second profile
- Alarm occurrence and its information
- Page number and Thermo Scientific logo

Page 5 contains:

- “Printed” date and time as header
- Current view of the graph
- Page number and Thermo Scientific logo

Review Profile Print is a 3 page report.

Page 1 contains:

- “Printed” date and time, Controlled-Rate Freezer review data report as header
- Profile name
- Run file name
- Information fields - Data Tag, Date & Time of execution, Operator name, Cryoprotectant with Data, Media with data, Sample Type with data and notes entered by the user.
- Page number and Thermo Scientific logo

Page 2 contains:

- “Printed” date and time, date/time of execution as header
- Profile steps
- Alarms occurrence time with alarm information
- Page number and Thermo Scientific logo

Page 3 contains:

- “Printed” date and time as header
- Current view of the graph
- Page number and Thermo Scientific logo

Information Fields

Information fields on the Review screen will appear as they were created for the Run data file that has been opened. The following information fields will be supported.

1. Profile name:
 - a. Initially will be blank and not editable
 - b. Populates the profile name once the Run file is loaded.
2. Date/Time:
 - a. Initially will be blank and not editable
 - b. Populates the Date/Time once the Run file is loaded.
3. Operator:
 - a. Initially will be blank and not editable
 - b. Populates the Operator name once the Run file is loaded
4. Cryoprotectant:
 - a. Initially will be blank
 - b. Populates the Cryoprotectant once the Run file is loaded if the data is available in run file
5. Media:
 - a. Initially will be blank
 - b. Populates the media value once the Run file is loaded if the data is available in run file
6. Sample Type:
 - a. Initially will be blank
 - b. Populates the sample once the Run file is loaded if the data is available in run file
7. Data Tag:
 - a. Initially will be blank
 - b. Populates the Data Tag once the Run file is loaded
8. Custom fields if added by the user
 - a. Initially will be blank
 - b. Populates the Custom fields data once the Run file is loaded if the data is available in run file
9. Profile Steps:
 - a. Initially will be blank
 - b. Populates Profile steps once the Run file is loaded
10. Notes:
 - a. Initially will be blank
 - b. Populates notes once the Run file is loaded if data is available in run file.

Options Screen

Options enable the user to perform the following functions:

- Set or change the plot colors
- Set or change default directories
- Add users
- Define information fields

Plot Colors

The Plot Colors screen allows a user to set the colors of the graph.

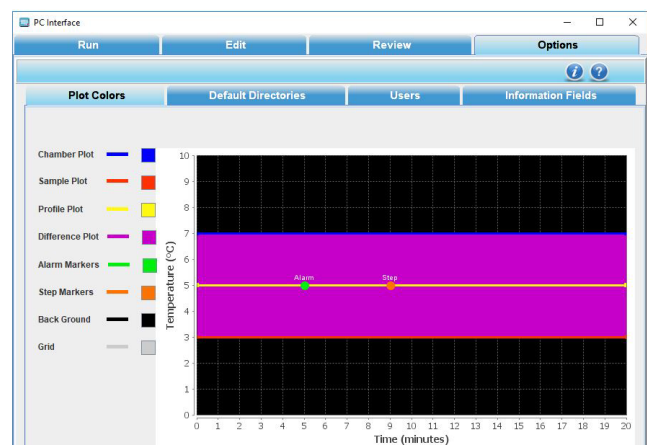

Figure 157. Plot Colors

The Plot Colors window indicates the graph color choices.

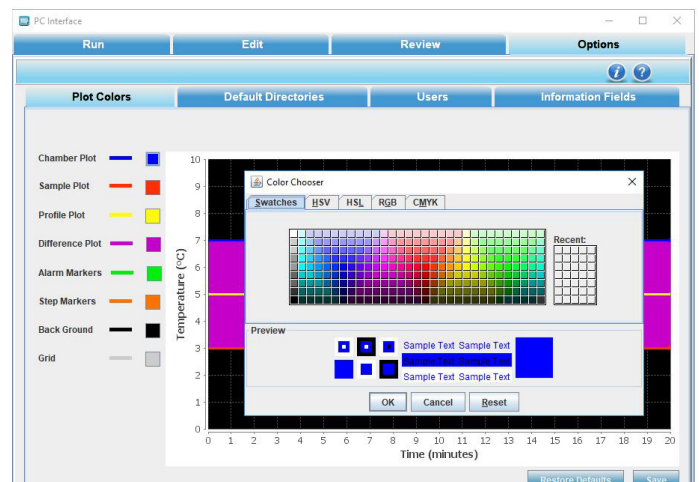

Figure 158. Plot Color Choices

Description

1. Plot Items are displayed as follows:
 - a. Sample Plot: Orange
 - b. Chamber Plot: Blue
 - c. Profile Plot: Yellow
 - d. Difference Plot: Pink
 - e. Alarm Markers: Green
 - f. Step Markers: Orange
 - g. Background: Black
 - h. Grid Color: Gray
2. Procedure:
 - a. To choose colors, user can select the color box corresponding to the desired plot item. The color palette shows the different colors available.
 - b. Select “Save” to keep changes.
 - c. To return to previously saved colors, select “Restore Defaults”.

Default Directories

This screen enables the user to change the default directory settings. The user can define the default profile directory and default run directory to store the program profiles and run profiles. The default folder paths are installation folders Program and Run.

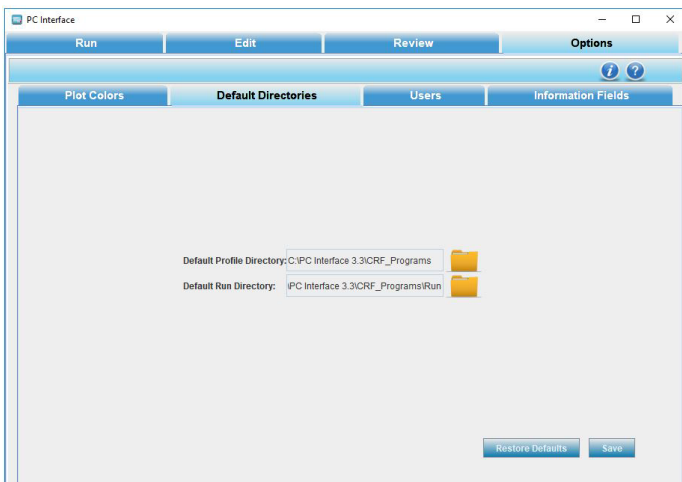

Figure 159. Default Directories

To set default directories,

1. Click Default profile Directory folder icon. The Open window dialog box appears.
2. Select the path of the directory and click Open.
3. Click Default Run Directory. The Open window dialog box appears.
4. Select the path and click Open. When selecting the file path, it is recommended to browse to your desired directory or type in the full path (case sensitive).
5. Click Save. The default directories path is now saved.
6. Click Restore Defaults to restore the previous path.

Note: Network drives might not be supported if user’s computer is not registered to the network.

Users

This section enables a user to add new users, modify passwords and delete existing users.

The following image shows the “add new user” screen.

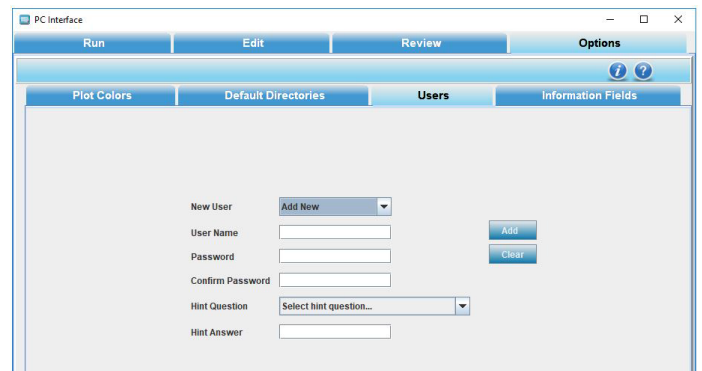

Figure 160. Add New User

A user can also delete other users. The following image shows edit password and delete user screen



Figure 161. Edit Password/Delete User

Note: When all the users are deleted, the PC software can be accessed as an anonymous user. If current user is deleted, application will be closed.

User name Policies

- To access the application in user's mode, a new user will have to be set up. Users cannot be imported from other applications or previous versions of Thermo Scientific CRF software.
- All existing users will be displayed in a list/scrollbar.
- The new user account will be created when the "Add" button is clicked.
- To add a user, provide Password and Confirm Password field data. If they match, only then will new user details will be added.
- The created user will be reflected in the existing user list box.
- If user selects a name already taken, selected user name will be populated.
- User name length must be between 7 to 12 characters.
- First character in user name can be '\$' or '_' or alphabet.
- Second character can be '\$' or '_' or '@' or alphabet or digit.
- From third character onwards, user name can contain digits or special characters.
- User name must not contain spaces or the new line character.
- To delete a user name, select the user name from the pull-down list (or type name in User Name window) and click the "Delete" button. Any user can delete another user. An unlimited number of users can be created.
- No user can delete the anonymous user account.
- A user can also delete his account, but only if the run initiated by that user has completed.
- If all the user accounts are deleted, then Anonymous mode will be activated automatically.

Password Policies

- Password length must be between 8 to 12 characters.
- Password can contain any combination of minimum one Uppercase (A - Z), Lowercase (a - z), Numbers (0 - 9), Special characters (@#\$%^&+=).
- Changing a user's password will require confirmation.
- To change a password, select the user name from the pull-down list (or type the name in User Name window), enter and confirm the new password, and lastly click the "Add" button.
- Save the changes to ".properties" file.

- One user will not be able to change another's password, as changing a user's password will require his old password.

Anonymous User Policies

- Anonymous can create other users.
- Anonymous does not exist once the users are added.
- Anonymous cannot delete any users.
- Anonymous cannot change other user's password.

Error Messages in User

Description of error messages that occur when user enters incorrect information are as follows:

Table 12. Error Messages in User

Error Message
This message appears if the user enters user name not between 7 & 12 characters.

This message appears if the user enters password not between 8 & 12 characters.

This message appears when the password and confirm password are not matching.

This message appears when Hint Question and Answer are blank.

Table 12. Error Messages in User

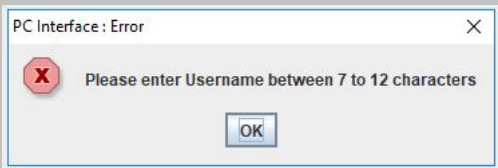
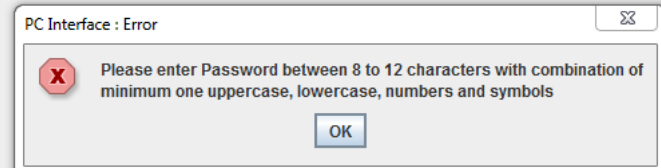
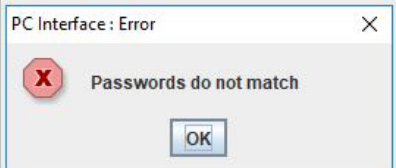
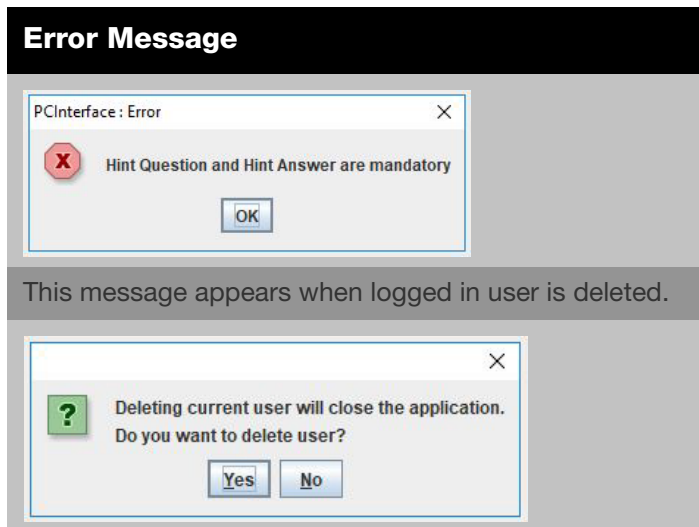

- Information Field name length must be a minimum 5 characters.
- Information Field name must not start with any special character or numerical value. It must start with a letter only.
- Information Field name can contain a special character as the second character or thereafter.
- Default information fields are Profile Name, Data Tag, Date/Time, Operator, Cryoprotectant, Media, and Sample Type.
- The additional fields are stored in “.properties” file.
- All fields including default Information fields are maximum of 20 characters only.

To remove a field.

1. Select the “delete” field. A dialog box appears.
2. Select the field and click “OK.”

Note: Mandatory fields are not removable. Mandatory fields are denoted with an “*.”

Information Fields

This section enables the user to add or delete information fields of a freezer profile. There are seven information fields that are predefined such as, Cryoprotectant, Data Tag, Date/Time, Media, Operator, profile Name and Sample Type. The information fields that are added are available in subsequent runs.

The user can add 5 additional fields. The total number of information fields that can be defined is 12 including the default information fields.

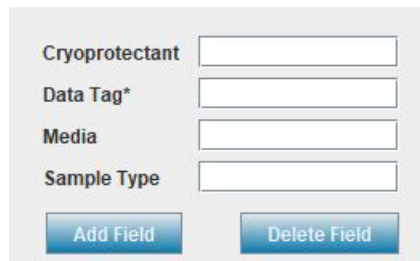
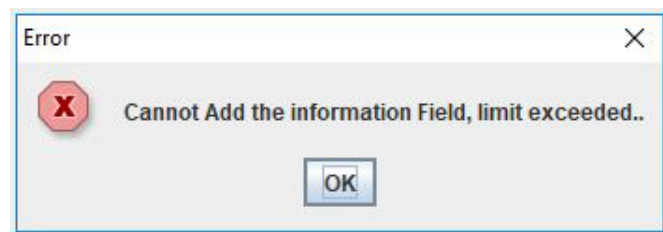

Figure 162. Add Information Fields

The below error message is displayed when the user tries to add more than 5 custom fields.



- The new fields that are added cannot have the same name as a default predefined field.

Status Bar

The status bar displays the commands or the actions to perform in the bottom left corner of the window and status of connection between the unit and the PC software (unit connected or unit not connected), the port connected and the user name in the bottom right corner of the window.

Figure 163 shows the status bar.



Figure 163. Status Bar

Help

The Help section assists the user in navigating through the PC Software.

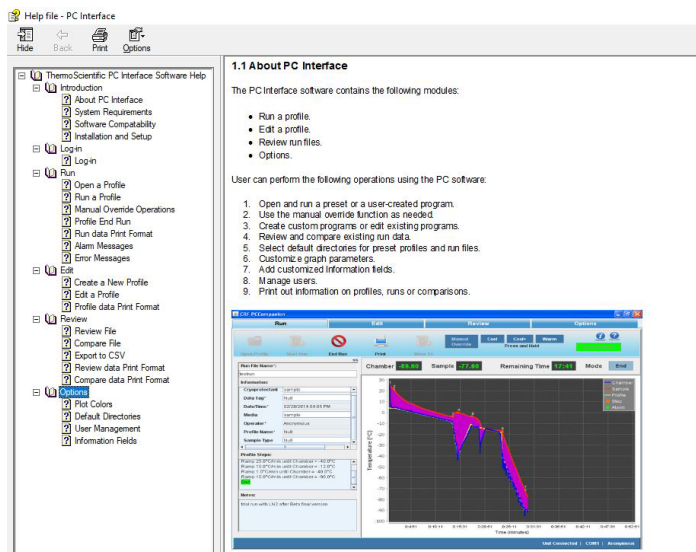

Figure 164. Help File

About

This section provides information for Thermo Fisher, the OS compatibility, and the software version of the application.

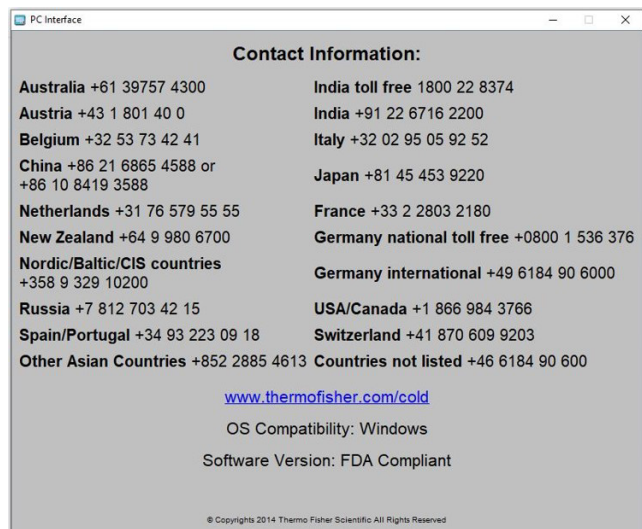

Figure 165. Information

Maintenance



WARNING: Be sure to shut down the unit using shut down button (**Figure 2**) to disconnect the unit from the power source before beginning of any service work.



CAUTION: Before using any cleaning or decontamination method except those recommended by the manufacturer, users must check with the manufacturer that the proposed method will not damage the equipment.



CAUTION: Do not use strong alkaline or caustic agents. Stainless steel is corrosion-resistant, not corrosion-proof. Do not use a solution of sodium hypochlorite (bleach) as it can cause pitting and rusting.



WARNING: Alcohol, even a 70% solution, is volatile and flammable. Use it only in a well ventilated area that is free from open flame. If any component is cleaned with alcohol, do not expose the component to open flame or other possible hazard. Allow the alcohol to fully dry before turning power on.

Dry Gaskets and Heat Breaks

Thoroughly dry the door and chamber opening gaskets and heat breaks after each run using a soft cloth to prevent ice build-up which could reduce the effectiveness of the door seal. Immediately clean up any water that may drip onto the floor in order to prevent a potential slip or fall hazard.

Disinfect Controlled-Rate Freezer Interior

Use an appropriate disinfectant. All articles and surfaces to be disinfected must be thoroughly cleaned, rinsed and rough dried.

1. Shut down the freezer using soft shut down button Turn the freezer off and disconnect the plug from the power source.
2. Unplug and remove the Sample probe from the chamber, clean with alcohol and allow to dry.

3. Wash the cabinet interior using a non-abrasive cloth and disinfectant starting at the top and working down. The cabinet and door must be rinsed with sterile water until the disinfectant has been removed. After the cabinet has been rinsed, spray with 70% alcohol.
4. Allow the cabinet door to remain open for the alcohol to evaporate.
5. Plug the freezer in and turn the power switch on.

Clean a Major Spill in the Chamber



WARNING: Be sure to shut down the freezer using soft shut down button and turn the unit circuit breaker off and disconnect the unit from the power source to prevent the chamber fan from starting unexpectedly while the duct sheets are removed for cleaning.

1. Remove the two screws at the top and bottom of each side, securing the screened side ducts to the chamber. Set the ducts aside.
2. Press the top and bottom edges of the center duct toward each other and draw the duct outward to remove.
3. The chamber is now fully accessible and can be cleaned.
4. Clean the interior of the unit with an appropriate disinfectant. Clean, rinse and wipe dry, as needed. Clean the screened side ducts and center ducts before reinstalling.
5. Press the top and bottom edges of the center duct toward each other and insert the duct into the center of the chamber. The edges fit inside the door gasket.
6. Install each screened side duct. Locate the tabs on the back of each duct into the proper holes at the back of the chamber. Align the two screw holes and secure at the top and bottom of each side.



CAUTION: Be sure all chamber components are re-installed in the proper locations to avoid compromising the chamber airflow and temperature uniformity.



CAUTION: Avoid damaging the chamber opening gasket.

7. Connect the Sample probe to the connector.
8. All chamber parts must be re-installed for consistent uniformity and airflow. Connect the unit to the power source and turn it on.
9. The freezer is ready to be returned to service.

Clean the Cabinet Exterior

Clean the freezer exterior with a damp sponge or soft, well-wrung cloth and mild detergent dissolved in water. Dry with a soft cloth.

Solenoid Valve Maintenance

Operation

Normally closed: Valve is closed when solenoid is de-energized, valve is open when solenoid is energized.



WARNING: These procedures must be performed by qualified service technicians.

Cleaning

A periodic cleaning of all solenoid valves is recommended. The time between cleanings will vary, depending upon media and service conditions. Generally, if the voltage to the coil is correct, sluggish valve operation, excessive noise, or leakage will indicate that cleaning is required.

The unit will track the valve cycle counts for each valve and will notify the user when a valve is approaching end of life. When a profile run completes and a valve is past the end of life recommended cycle count, a dialog will be displayed on the UI screen.

Reset Heater Over temp Thermostat



WARNING: Only qualified service personnel or persons experienced in servicing and maintaining laboratory equipment should perform this procedure.

The thermostat will disable heater operation if the sidecar temperature exceeds 92°C. If this occurs, a service technician will be required to reset the thermostat to resume normal operation.

Preventive Maintenance

Your equipment has been thoroughly tested and calibrated before shipment. Regular preventive maintenance is important to keep your unit functioning properly. The operator should perform routine cleaning and maintenance on a regular basis. For maximum performance and efficiency, it is recommended that the unit be checked and calibrated periodically by a qualified service technician.

We have qualified service technicians, using NIST traceable instruments, available in many areas. For more information on Preventive Maintenance or Extended Warranties, contact Technical Services.

The following is a condensed list of preventative maintenance requirements. Refer to **Table 13**.

Cleaning and calibration adjustment intervals are dependent upon use, environmental conditions and accuracy required.

Table 13. Preventative Maintenance Requirements

Action	Each Use	Daily	Weekly	Monthly	Yearly
Dry door and chamber opening gasket and heat breaks	✓				
Disinfect chamber interior		✓			
Clean cabinet exterior			✓		
Check calibration of internal and sample probes				✓	
Battery					✓
Inspect solenoid valve*					✓

*Qualified service technicians only.

Troubleshooting

This section is a guide to troubleshooting general operational problems.

Table 14. Troubleshooting Table

Symptom	Possible Cause	Verification	Solution
Front UI LED Not On	Power cord unplugged	Verify power cord is plugged into outlet and to unit power inlet	Plug in the power cord to the outlet and to the unit power inlet
	Breaker in 'Off' Position	Verify the breaker position	Turn the breaker to the 'On' position
Front UI LED Red	Power cord unplugged	Verify power cord is plugged into outlet and to unit power inlet	Plug in the power cord to the outlet and to the unit power inlet
	Breaker in 'Off' Position	Verify the breaker position	Turn the breaker to the 'On' position
Heater Error Alarm	LN ₂ supply tank empty	Verify supply tank contents adequate	Replace/Fill LN ₂ Tank
	Low LN ₂ pressure	Verify tank pressure (regulator: 22# nominal)	Replace Tank/Regulator
	LN ₂ supply hose too long	4'/6' flex line to tank or vacuum insulated plumbing	Replace/Upgrade Hose/Plumbing
	LN ₂ solenoids bad	Check for valve counter warning dialogue after run completion	Contact service to replace valves
Erratic Chamber Temperature	High LN ₂ Pressure	Verify tank pressure (regulator: 22# nominal)	Replace/Fill LN ₂ Tank
	Chamber Thermocouple Mounting	Verify that the chamber temperature probe is properly seated in the sleeve by verifying the blue marking is flush with the frame. Refer to (calibration installation figure number)	Adjust thermocouple position
Erratic Sample Temperature	Sample thermocouple positioning	If using a press, ensure sensor is oriented properly to avoid metal contact	Correct the sensor orientation so that it is not making contact with the metal
Inaccurate Chamber Temperature	Old calibration	Verify last date of calibration is < 1 month from the current date	Recalibrate probes
	Inaccurate calibration	Verify calibration values are reasonable. Refer to calibration section for expected range of values	Recalibrate probes
Inaccurate Sample Temperature	Old calibration	Verify last date of calibration is < 1 month from the current date	Recalibrate probes
	Inaccurate calibration	Verify calibration values are reasonable. Refer to calibration section for expected range of values	Recalibrate probes

Table 14. Troubleshooting Table

Symptom	Possible Cause	Verification	Solution
Printer Error LED	Printer Error	Refer to printer error code table to diagnose	Refer to printer error code table and take appropriate action
Printer Power LED Off	Printer Off	Check power connections at printer Verify printer is on.	Connect power cable to printer Press Power button.
Printer Does not Print	Printer USB Disconnected	Check USB connection at printer	Plug in USB to printer
	Printer Off	Verify printer is on.	Press Power button.
	Printer Error	Refer to printer error code table to diagnose	Refer to printer error code table and take appropriate action
PC Interface	Login Errors	Refer to PC Interface Login Error Messages section of manual	Refer to PC Interface Login Error Messages section of manual
	COM Port Error	Refer to PC Interface Installation section of manual	Refer to PC Interface Installation section of manual
USB Exporting	Drive file system format	Verify drive is compatible of file system format (ex.FAT32)	Drive should be compatible
	Available memory	Verify drive has 1 MB of memory	Memory space should be available in the drive
Ice build up around door	Door not latched properly	Verify door is latched properly Verify the gasket is fully sealed	Latch the door properly and seal the gasket

Connectivity Troubleshooting

This section is a guide to troubleshooting general connectivity problems.

Table 15. Connectivity Troubleshooting Table

Problem	Cause	Solution
Connectivity	Dongle Unplugged	Verify that the WiFi dongle is plugged into a USB port.
Wireless Network (SSID) is not appearing in configuration	Invalid network name	Verify that the correct network name is provided.
	Network (SSID) is not visible (Not being broadcasted)	Verify that the network (SSID) is visible (being broadcasted) using a mobile device. *Thermo Fisher Devices are not able to connect to SSID's that are not being broadcasted.
	Network is not compatible with 802.11 WiFi dongle	Verify with local IT that the network is compatible with 802.11b/g/n. *Freezers only support 2.4GHz frequencies; 5GHz frequencies are not supported.
	UI firmware	Contact Service.
Freezer will not connect to a Wireless Network (SSID)	Invalid SSID and/or Password	Verify that you are connecting to the correct network (SSID) and are entering the correct password. (Suggestion: attempt the same network connection via an alternate device, like a cell phone, laptop, or tablet.) Try restarting the freezer and re-attempt to establish the WiFi connection.
	Network (SSID) requires user acceptance or input via a web browser	Verify that the network (SSID) is not dependent on accessing a web page first. *Freezers are not compatible with WiFi networks that require a login via web page, such as many "guest" or "visitor" networks, these networks will cause the WiFi connection to fail.
	Weak Signal Strength (RSSI)	Verify that the network (SSID) signal strength (RSSI) has a minimum value of at least -67dBm at the wireless interface of the device. Verify with local IT if MAC address filtering is in place.
	MAC Address Filtering	If MAC address filtering is in place, work with local IT to get the device added to an approved list. *Navigate to Settings -> Connectivity -> WiFi to see the MAC address.

Table 15. Connectivity Troubleshooting Table

Problem	Cause	Solution
Connectivity Options in Freezer UI are greyed out and non-responsive Device not connecting to the Cloud Portal	Firewall ports closed	Verify with local IT that ports 443, 123, and 80 are open to the Internet in the facility's firewall.
		Use the Telnet app from a computer on the same network. *Telnet is NOT enabled by default in Windows *telnet apps.thermofisher.com 443 *telnet apps.thermofisher.com 123
	Connect device to cloud using 3G/4G hotspot	Confirm if the hotspot works at the unit location and allows internet connection using a laptop or tablet.
		If the device connects and is able to access the cloud through the hotspot, the issue is with IT security. Work with local IT to resolve the issue. If the device does not connect through the hotspot, contact Service.
	UI firmware	Contact Service.

Note: After resetting (unit factory reset) and reconnecting to InstrumentConnect, the freezer will appear as a new connection within the user's connected devices on InstrumentConnect. This is because a new security certificate will be established. The freezer will be unable to re-connect to the original device under the "old" security certificate.

Appendix A: User Role Summary

Table 16. User Role Permissions

Feature	Admin	User Role 1	User Role 2
Home	<ul style="list-style-type: none"> • Able to start warming mode • Able to Run Last • Able to Review Last 	<ul style="list-style-type: none"> • Able to start warming mode • Able to Run Last • Able to Review Last 	<ul style="list-style-type: none"> • Able to start warming mode • Able to Run Last • Able to Review Last
Settings	<ul style="list-style-type: none"> • Able to access / see alarms, chart, connectivity, custom fields, display, printer, security • Not able to see service 	<ul style="list-style-type: none"> • Able to access printer, display and about • Not Able to see service 	<ul style="list-style-type: none"> • Able to access printer, display and about • Not Able to see service
Run Review	<ul style="list-style-type: none"> • No restrictions (able to view and export reports) 	<ul style="list-style-type: none"> • No restrictions (able to view and export reports) 	<ul style="list-style-type: none"> • No restrictions (able to view and export reports)
Log Review	<ul style="list-style-type: none"> • No restrictions (able to view and export reports) 	<ul style="list-style-type: none"> • No restrictions (able to view and export reports) 	<ul style="list-style-type: none"> • No access
Profile	<ul style="list-style-type: none"> • Able to select and start a run • Able to modify a custom profile • Able to create a profile 	<ul style="list-style-type: none"> • Able to select and start a run • Able to modify a custom profile 	<ul style="list-style-type: none"> • Able to select and start a run
User	<ul style="list-style-type: none"> • Able to view all users (inactive and active) • Able to reset other users passwords via PIN (including other admins) • Able to only view themselves and change their password and other information (not user name) 	<ul style="list-style-type: none"> • Able to only view themselves and change their password and other information (not user name) 	<ul style="list-style-type: none"> • Able to only view themselves and change their password and other information (not user name)
Calibrate	<ul style="list-style-type: none"> • Able to access and modify the calibration settings 	<ul style="list-style-type: none"> • Able to view the calibration settings. 	<ul style="list-style-type: none"> • Able to view the calibration settings.

Appendix B: City Time Zone

Time specified in the time zone indicates the difference with UTC.

Table 17. City Time Zone

Time Zone	City	
(Africa +00:00)	ElAaiun	
	Freetown	
	Lome	
	Abidjan	
	Accra	
	Bamako	
	Banjul	
	Bissau	
	Casablanca	
	Conakry	
	Dakar	
	Monrovia	
	Nouakchott	
	Ouagadougou	
	(Africa +01:00)	Algiers
		Bangui
Brazzaville		
Ceuta		
Douala		
Kinshasa		
Lagos		
Libreville		
Luanda		
Malabo		
Ndjamena		
Niamey		
Porto-Novo		

Table 17. City Time Zone

Time Zone	City	
	Sao_Tome	
	Tunis	
(Africa +02:00)	Gaborone	
	Harare	
	Johannesburg	
	Khartoum	
	Kigali	
	Lubumbashi	
	Lusaka	
	Maputo	
	Blantyre	
	Bujumbura	
	Cairo	
	Maseru	
	Mbabane	
	Tripoli	
	Windhoek	
	(Africa +03:00)	Juba
Kampala		
AddisAbaba		
Asmara		
DaresSalaam		
Djibouti		
Mogadishu		
Nairobi		
(America +00:00)		Danmarkshavn
(America -01:00)		Scoresbysund
(America -02:00)	Noronha	

Table 17. City Time Zone

Time Zone	City
(America -03:00)	Araguaina
	Bahia
	Belem
	Cayenne
	Fortaleza
	Godthab
	Maceio
	Miquelon
	Montevideo
	Paramaribo
	Recife
	Santarem
	SaoPaulo
(America -03:30)	StJohns
(America -04:00)	Anguilla
	Antigua
	Aruba
	Asuncion
	Barbados
	Blanc-Sablon
	BoaVista
	CampoGrande
	Caracas
	Cuiaba
	Curacao
	Dominica
	GlanceBay
	GooseBay
	GrandTurk
(America -04:00)	Grenada
	Guadeloupe
	Guyana

Table 17. City Time Zone

Time Zone	City
	Halifax
	Kralendijk
	LaPaz
	LowerPrinces
	Manaus
	Marigot
	Martinique
	Moncton
	Montserrat
	PortofSpain
	PortoVelho
	PuertoRico
	Santiago
	SantoDomingo
	StBarthelemy
	StKitts
	StLucia
	StThomas
	StVincent
	Thule
	Tortola
(America -05:00)	Atikokan
	Bogota
	Cancun
	Cayman
	Detroit
	Eirunepe
	Guayaquil
	Havana
(America -05:00)	Iqaluit
	Jamaica
	Lima

Table 17. City Time Zone

Time Zone	City
	Nassau
	NewYork
	Nipigon
	Panama
	Pangnirtung
	Port-au-Prince
	RioBranco
	ThunderBay
	Toronto
(America -06:00)	BahiaBanderas
	Belize
	Chicago
	CostaRica
	ElSalvador
	Guatemala
	Managua
	Matamoros
	Menominee
	Merida
	MexicoCity
	Monterrey
	RainyRiver
	RankinInlet
	Regina
	Resolute
	SwiftCurrent
	Tegucigalpa
	Winnipeg
(America -07:00)	Boise
	CambridgeBay
	Chihuahua
	Creston

Table 17. City Time Zone

Time Zone	City
	DawsonCreek
	Denver
	Edmonton
	FortNelson
	Hermosillo
	Inuvik
	Mazatlan
	Ojinaga
	Phoenix
	Yellowknife
(America -08:00)	Dawson
	LosAngeles
	Tijuana
	Vancouver
	Whitehorse
(America -09:00)	Anchorage
	Juneau
	Metlakatla
	Nome
	Sitka
	Yakutat
(America -10:00)	Adak
(Antarctica +00:00)	Troll
(Antarctica +03:00)	Syowa
(Antarctica +05:00)	Mawson
(Antarctica +06:00)	Vostok
(Antarctica +07:00)	Davis
(Antarctica +10:00)	DumontDUrville
(Antarctica +11:00)	Casey
(Antarctica +12:00)	McMurdo
(Antarctica -03:00)	Palmer
	Rothera

Table 17. City Time Zone

Time Zone	City
(Arctic +01:00)	Longyearbyen
(Asia +02:00)	Amman
	Beirut
	Damascus
	Famagusta
	Gaza
	Hebron
	Jerusalem
(Asia +03:00)	Aden
	Baghdad
	Bahrain
	Kuwait
	Qatar
	Riyadh
(Asia +03:30)	Tehran
(Asia +04:00)	Baku
	Dubai
	Muscat
	Tbilisi
	Yerevan
(Asia +04:30)	Kabul
(Asia +05:00)	Aqtau
	Aqtobe
	Ashgabat
	Dushanbe
	Karachi
	Oral
	Samarkand
	Tashkent
	Yekaterinburg
(Asia +05:30)	Colombo
	Kolkata

Table 17. City Time Zone

Time Zone	City
(Asia +05:45)	Kathmandu
(Asia +06:00)	Almaty
	Dhaka
	Omsk
	Qyzylorda
	Thimphu
	Urumqi
(Asia +08:00)	Brunei
	Choibalsan
	HongKong
	Irkutsk
	KualaLumpur
	Kuching
	Macau
	Makassar
	Manila
	Shanghai
	Singapore
	Taipei
	Ulaanbaatar
(Asia +08:30)	Pyongyang
(Asia +09:00)	Chita
	Dili
	Jayapura
	Khandyga
	Seoul
	Tokyo
	Yakutsk
(Asia +10:00)	Ust-Nera
	Vladivostok
(Asia +11:00)	Magadan
	Sakhalin

Table 17. City Time Zone

Time Zone	City
	Srednekolymysk
(Asia +12:00)	Anadyr
	Kamchatka
(Atlantic -01:00)	Azores
	CapeVerde
(Atlantic -02:00)	SouthGeorgia
(Atlantic -03:00)	Stanley
(Atlantic -04:00)	Bermuda
(Atlantic +00:00)	Canary
	Faroe
	Madeira
	Reykjavik
	StHelena
(Australia +08:00)	Perth
(Australia +08:45)	Eucla
(Australia +09:30)	Adelaide
	BrokenHill
	Darwin
(Australia +10:00)	Brisbane
	Currie
	Hobart
	Lindeman
	Melbourne
	Sydney
(Europe +00:00)	Dublin
	Guernsey
	IsleofMan
	Jersey
	Lisbon
	London
(Europe +01:00)	Amsterdam
	Andorra

Table 17. City Time Zone

Time Zone	City
	Belgrade
	Berlin
	Bratislava
	Brussels
	Budapest
	Busingen
	Copenhagen
	Gibraltar
	Ljubljana
	Luxembourg
	Madrid
	Malta
	Monaco
	Oslo
	Paris
	Podgorica
	Prague
	Rome
	SanMarino
	Sarajevo
	Skopje
	Stockholm
	Tirane
	Vaduz
	Vatican
	Vienna
	Warsaw
	Zagreb
	Zurich
(Europe +02:00)	Athens
	Bucharest
	Chisinau

Table 17. City Time Zone

Time Zone	City
	Helsinki
	Kaliningrad
	Kiev
	Mariehamn
	Riga
	Sofia
	Tallinn
	Uzhgorod
	Vilnius
	Zaporozhye
(Europe +03:00)	Istanbul
	Kirov
	Minsk
	Moscow
	Simferopol
	Volgograd
(Europe +04:00)	Astrakhan
	Samara
	Ulyanovsk
(Indian +03:00)	Antananarivo
	Comoro
	Mayotte
(Indian +04:00)	Mahe
	Mauritius
	Reunion
(Indian +05:00)	Kerguelen
	Maldives
(Indian +06:00)	Chagos
(Indian +06:30)	Cocos
(Indian +07:00)	Christmas
(Pacific -11:00)	Midway
	Niue

Table 17. City Time Zone

Time Zone	City
	PagoPago
(Pacific -10:00)	Honolulu
	Johnston
	Rarotonga
	Tahiti
(Pacific -09:30)	Marquesas
(Pacific -09:00)	Gambier
(Pacific -08:00)	Pitcairn
(Pacific -06:00)	Easter
	Galapagos
(Pacific +09:00)	Palau
(Pacific +10:00)	Chuuk
	Guam
	PortMoresby
	Saipan
(Pacific +11:00)	Bougainville
	Efate
	Guadalcanal
	Kosrae
	Norfolk
	Noumea
	Pohnpei
(Pacific +12:00)	Auckland
	Fiji
	Funafuti
	Kwajalein
	Majuro
	Nauru
	Tarawa
	Wake
	Wallis
(Pacific +12:45)	Chatham

Table 17. City Time Zone

Time Zone	City
(Pacific +13:00)	Apia
	Enderbury
	Fakaofu
	Tongatapu
(Pacific +14:00)	Kiritimati

Warranty

Thermo Fisher Scientific PC and Peripheral Warranty

The warranty on any of the computer components must be referred to the component manufacturer. Please contact them as needed.

The Technical Services Department may be contacted for set-up and operational questions on the Controlled-Rate Freezer and PC interface, 1-888-213-1790. Printed instruction manuals carefully detail equipment installation, operation and preventive maintenance.

Thermo shall not be liable for any indirect or consequential damages including, without limitation, damages relating to lost profits or loss of products.

If equipment service is required, please call your Technical Services Department at 1-800-438-4851 (USA and Canada) or 1-740-373-4763. We're ready to answer your questions on equipment warranty, operation, maintenance, service and special application. Outside the USA, contact your local distributor for warranty information.

Thermo Fisher Scientific International Dealer PC and Peripherals Warranty

The Warranty on any of the computer components must be referred to the component manufacturer. Please contact them as needed.

The Technical Services Department may be contacted for set-up and operational questions on the Controlled-Rate Freezer and PC interface, 1-888-213-1790. Printed instruction manuals carefully detail equipment installation, operation and preventive maintenance.

Thermo shall not be liable for any indirect or consequential damages including, without limitation, damages relating to lost profits or loss of products.

Your local Thermo Sales Office is ready to help with comprehensive site preparation information before your equipment arrives. Printed instruction manuals carefully detail equipment installation, operation and preventive maintenance.

If equipment service is required, please call your Thermo Services Department at 1-800-438-4851 (USA or Canada), or 1-740-373-4763. We're ready to answer your questions on equipment warranty, operation, maintenance, service and special application. Outside the USA, contact your local distributor for warranty information.

Thermo Fisher Scientific Controlled-Rate Freezer Warranty

The Warranty Period starts two weeks from the date your equipment is shipped from our facility. This allows for shipping time so the warranty will go into effect at approximately the same time your equipment is delivered. The warranty protection extends to any subsequent owner during the first year warranty period.

During the first year, component parts proven to be non-conforming in materials or workmanship will be repaired or replaced at Thermo's expense, labor included. Installation and calibration are not covered by this warranty agreement. The Technical Services Department must be contacted for warranty determination and direction prior to performance of any repairs. Expendable items, glass, filters, gaskets, personal computers, monitors and inkjet printers are excluded from this warranty.

Replacement or repair of components parts or equipment under this warranty shall not extend the warranty to either the equipment or to the component part beyond the original warranty period. The Technical Services Department must give prior approval for return of any components or equipment. At Thermo's option, all defective parts must be returned to Thermo postage paid and replacement parts are shipped FOB destination.

THIS WARRANTY IS EXCLUSIVE AND IN LIEU OF ALL OTHER WARRANTIES, WHETHER WRITTEN, ORAL OR IMPLIED. NO WARRANTIES OF MERCHANTABILITY OR FITNESS FOR A PARTICULAR PURPOSE SHALL APPLY. Thermo shall not be liable for any indirect or consequential damages including, without limitation, damages relating to lost profits or loss of products.

Your local Thermo Sales Office is ready to help with comprehensive site preparation information before your equipment arrives. Printed operating manuals carefully detail equipment installation, operation and preventive maintenance.

If equipment service is required, please call your Technical Services Department at 1-800-438-4851 (USA and Canada) or 1-740-373-4763. We're ready to answer your questions on equipment warranty, operation, maintenance, service and special application. Outside the USA, contact your local distributor for warranty information.

Thermo Fisher Scientific International Controlled-Rate Freezer Dealer Warranty

The Warranty Period starts two months from the date your equipment is shipped from our facility. This allows for shipping time so the warranty will go into effect at approximately the same time your equipment is delivered. The warranty protection extends to any subsequent owner during the first year warranty period. Dealers who stock our equipment are allowed an additional six months for delivery and installation, provided the warranty card is completed and returned to the Technical Services Department.

During the first year, component parts proven to be non-conforming in materials or workmanship will be repaired or replaced at Thermo's expense, labor excluded. Installation and calibration are not covered by this warranty agreement. The Technical Services Department must be contacted for warranty determination and direction prior to performance of any repairs. Expendable items, glass, filters, gaskets, personal computers, monitors & ink-jet printers are excluded from this warranty.

Replacement or repair of components parts or equipment under this warranty shall not extend the warranty to either the equipment or to the component part beyond the original warranty period. The Technical Services Department must give prior approval for return of any components or equipment. At Thermo's option, all defective parts must be returned to Thermo postage paid and replacement parts are shipped FOB destination.

THIS WARRANTY IS EXCLUSIVE AND IN LIEU OF ALL OTHER WARRANTIES, WHETHER WRITTEN, ORAL OR IMPLIED. NO WARRANTIES OF MERCHANTABILITY OR FITNESS FOR A PARTICULAR PURPOSE SHALL APPLY. Thermo Forma shall not be liable for any indirect or consequential damages including, without limitation, damages relating to lost profits or loss of products.

Your local Thermo Sales Office is ready to help with comprehensive site preparation information before your equipment arrives. Printed instruction manuals carefully detail equipment installation, operation and preventive maintenance.

If equipment service is required, please call your Technical Services Department at 1-800-438-4851 (USA or Canada), or 1-740-373-4763. We're ready to answer your questions on equipment warranty, operation, maintenance, service and special application. Outside the USA, contact your local distributor for warranty information.

WEEE Compliance

WEEE Compliance. This product is required to comply with the European Union's Waste Electrical & Electronic Equipment (WEEE) Directive 2012/19/EU. It is marked with the following symbol. Thermo Fisher Scientific has contracted with one or more recycling/disposal companies in each EU Member State, and this product should be disposed of or recycled through them. Further information on our compliance with these Directives, the recyclers in your country, and information on Thermo Fisher Scientific products which may assist the detection of substances subject to the RoHS Directive are available at thermofisher.com/WEEERoHS.

Great Britain

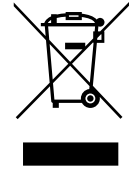

WEEE Konformität. Dieses Produkt muss die EU Waste Electrical & Electronic Equipment (WEEE) Richtlinie 2012/19/EU erfüllen. Das Produkt ist durch folgendes Symbol gekennzeichnet. Thermo Fisher Scientific hat Vereinbarungen getroffen mit Verwertungs-/Entsorgungsanlagen in allen EU-Mitgliederstaaten und dieses Produkt muss durch diese Firmen wiederverwertet oder entsorgt werden. Mehr Informationen über die Einhaltung dieser Anweisungen durch Thermo Fisher Scientific, die Verwerter und Hinweise die Ihnen nützlich sein können, die Thermo Fisher Scientific Produkte zu identifizieren, die unter diese RoHS-Anweisung fallen, finden Sie unter thermofisher.com/WEEERoHS.

Deutschland



Conformità WEEE. Questo prodotto deve rispondere alla direttiva dell'Unione Europea 2012/19/EU in merito ai Rifiuti degli Apparecchi Elettrici ed Elettronici (WEEE). È marcato col seguente simbolo. Thermo Fisher Scientific ha stipulato contratti con una o diverse società di riciclaggio/smaltimento in ognuno degli Stati Membri Europei. Questo prodotto verrà smaltito o riciclato tramite queste medesime. Ulteriori informazioni sulla conformità di Thermo Fisher Scientific con queste Direttive, l'elenco delle ditte di riciclaggio nel Vostro paese e informazioni sui prodotti Thermo Fisher Scientific che possono essere utili alla rilevazione di sostanze soggette alla Direttiva RoHS sono disponibili sul sito thermofisher.com/WEEERoHS.

Italia



Conformité WEEE. Ce produit doit être conforme à la directive euro-péenne (2012/19/EU) des Déchets d'Equipements Electriques et Electroniques (DEEE). Il est marqué par le symbole suivant. Thermo Fisher Scientific s'est associé avec une ou plusieurs compagnies de recyclage dans chaque état membre de l'union européenne et ce produit devrait être collecté ou recyclé par celles-ci. Davantage d'informations sur la conformité de Thermo Fisher Scientific à ces directives, les recycleurs dans votre pays et les informations sur les produits Thermo Fisher Scientific qui peuvent aider la détection des substances sujettes à la directive RoHS sont disponibles sur thermofisher.com/WEEERoHS.

France

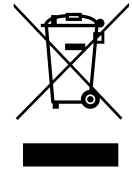

Regulatory

Product Safety

This product family has been tested to applicable product safety standards by Underwriters Laboratories (UL), which is a Nationally Recognized Test Laboratory (NRTL). The product bears the following mark



Conformity with European Regulations

The European voltage models of this product meet all the applicable requirements of the European Directives and therefore display the CE Marking. These Directives include those captured in the EU Declaration of Conformity.

The most current EU Declaration of Conformity may be obtained from the manufacturer.



21 CFR part 11

Disclaimer

The CryoMed models listed in this Operating and Maintenance manual support 21 CFR part 11 through a PDF file export and touchscreen UI. It can be used as a document management system in a regulated environment.

It is the user's responsibility to develop verification and validation protocol based on the record keeping requirements.

FCC Statement (USA)



Any changes or modifications not expressly approved by the party responsible for compliance could void the user's authority to operate the equipment.

Note: This equipment has been tested and found to comply with the limits for a Class A digital device, pursuant to part 15 of the FCC Rules. These limits are designed to provide reasonable protection against harmful interference when the equipment is operated in a commercial environment. This equipment generates, uses, and can radiate radio frequency energy and, if not installed and used in accordance with the instruction manual, may cause harmful interference to radio communications. Operation of this equipment in a residential area is likely to cause harmful interference in which case the user will be required to correct the interference at his own expense.

Canadian ISED IC Notice

This ISM digital apparatus complies with Canadian ICES-001.

Cet appareil ISM est conforme à la norme NMB-001 du Canada.

Korea KC



사용자 안내문

이 기기는 업무용 환경에서 사용할 목적으로 적합성평가를 받은 기기로서 가정용 환경에서 사용하는 경우 전파 간섭의 우려가 있습니다 .

WARNING: EMC Registration is done on this equipment for business use only. It may cause interference when the product would be used in home. This warning statement applies a product for business use.

Australi/New Zealand RCM

This product complies with all applicable standards for Australia and New Zealand.



Contact Information

Thermo Fisher Scientific products are backed by a global technical support team ready to support your applications. We offer cold storage accessories, including remote alarms, temperature recorders, and validation services.

Visit www.thermofisher.com/cold or call:

Countries	Sales
North America	+1 866 984 3766
India toll free	1800 419 5433
India	+91 22 6716 2200
China	+800 810 5118
Japan	+03-6832-9300
Australia	+1300 735 292
Belgium	+32 (0)9 272 54 82
France	+33 (0)2 28 03 21 80
Germany national toll free	(+49) 0800 1536 376
Italy	+32 02 95059 552
Netherlands	+31 (0) 76 579 55 55
Nordic/Baltic/CIS countries	+358 9 329 10200
Russia	+7 495 739 76 41
Spain/Portugal	+34 914 845 965
Switzerland	+49 (0) 6184906000
UK/Ireland	+44(0)870 609 9203
New Zealand	800 933 966
Countries not listed	+49 6184 90 6000

Thermo Fisher Scientific (Asheville) LLC.
401 Millcreek Road,
Marietta, Ohio 45750,
United States.

Find out more at thermofisher.com/cold

ThermoFisher
S C I E N T I F I C