



Thermo Scientific E1-ClipTip Electronic Pipette

Single Channel

Multichannel

Adjustable Tip Spacing Equalizer

User Manual

thermo
scientific

Regulatory Notices

FCC Class B Digital Devices Regulatory Notice

This equipment has been tested and found to comply with the limits for a Class B digital device, pursuant to Part 15 of the FCC Rules. These limits are designed to provide reasonable protection against harmful interference in a residential installation. This equipment generates, uses, and can radiate radio frequency energy and, if not installed and used in accordance with the instructions, may cause harmful interference to radio communications.

However, there is no guarantee that interference will not occur in a particular installation. If this equipment does cause harmful interference to radio or television reception, which can be determined by turning the equipment off and on, the user is encouraged to try to correct the interference by one or more of the following measures:

- Reorient or relocate the antenna
- Increase the separation between the equipment and receiver
- Connect the equipment into an outlet on a circuit different from that to which the receiver is connected
- Consult the dealer or an experienced radio or television technician for help

FCC Wireless Notice

This product emits radio frequency energy, but the radiated output power of this device is far below the FCC radio frequency exposure limits. Nevertheless, the device should be used in such a manner that the potential for human contact with the antenna during normal operation is minimized.

To meet the FCC's RF exposure rules and regulations:

- The system antenna used for this transmitter must not be co-located or operating in conjunction with any other antenna or transmitter.
- The system antenna used for this module must not exceed 4 dBi.
- Users and installers must be provided with antenna installation instructions and transmitter operating conditions for satisfying RF exposure compliance

FCC Interference Statement

This device complies with Part 15 of the FCC Rules. Operation is subject to the following two conditions:

1. This device may not cause harmful interference
2. This device must accept any interference received, including interference that may cause undesired operation

ISED Statement

This device complies with Industry Canada license-exempt RSS standard(s). Operation is subject to the following two conditions: (1) this device may not cause interference, and (2) this device must accept any interference, including interference that may cause undesired operation of the device.

Le présent appareil est conforme aux CNR d'Industrie Canada applicables aux appareils radio exempts de licence. L'exploitation est autorisée aux deux conditions suivantes : (1) l'appareil ne doit pas produire de brouillage, et (2) l'utilisateur de l'appareil doit accepter tout brouillage radioélectrique subi, même si le brouillage est susceptible d'en compromettre le fonctionnement.

Singapore compliance label



根據 NCC 低功率電波輻射性電機管理辦法規定：

第十二條

經型式認證合格之低功率射頻電機，非經許可，公司、商號或使用者均不得擅自變更 頻率、加大功率或變更原設計之特性及功能。

第十四條

低功率射頻電機之使用不得影響飛航安全及干擾合法通信；經發現有干擾現象時，應立即停用，並改善至無干擾時方得繼續使用。前項合法通信，指依電信法規定作業之無線電通信。低功率射頻電機須忍受合法通信或工業、科學及醫療用電波輻射性電機設備之干擾。

The Bluetooth® word mark and logos are registered trademarks owned by the Bluetooth SIG, Inc. and any use of such marks by Thermo Fisher Scientific is under license. Other trademarks and trade names are those of their respective owners.

Der Bluetooth®-Schriftzug und die Logos sind eingetragene Markenzeichen und Eigentum von Bluetooth SIG, Inc., und ihre Verwendung durch Thermo Fisher Scientific erfolgt in Lizenz. Andere Markenzeichen und Markennamen sind Eigentum der jeweiligen Rechteinhaber.

La marque et les logos Bluetooth® sont des marques déposées appartenant à Bluetooth SIG, Inc. et toute utilisation de ces marques par Thermo Fisher Scientific s'effectue sous licence. Les autres marques et noms commerciaux appartiennent à leurs propriétaires respectifs.

La marca de la palabra Bluetooth® y sus logotipos son marcas comerciales registradas propiedad de Bluetooth SIG, Inc. y cualquier uso de dichas marcas por parte de Thermo Fisher Scientific se realiza bajo licencia. Las demás marcas y nombres comerciales pertenecen a sus respectivos propietarios.

Bluetooth® のワードマークおよびロゴは、Bluetooth SIG, Inc.が所有する登録商標であり、[ライセンス名] はこれらのマークをライセンスに基づいて使用しています。その他の商標および商号は、それぞれの所有者に帰属します。

블루투스® 문자 상표 및 로고는 Bluetooth SIG, Inc. 소유의 등록 상표이며 Thermo Fisher Scientific 의 모든 해당 상표 사용은 라이선스 계약에 따릅니다. 기타 상표 및 상호는 해당 소유자의 소유입니다.



“해당무선설비는운용중
전파혼신가능성이있음”

인증번호: MSIP-CMM-the-E1-ClipTip BT

기가재의명칭/모델명: E1-ClipTip Electronic Pipette

적합성평가를받은자의상호: Thermo Fisher Scientific Oy

제조사/제조국가: Thermo Fisher Scientific Oy/핀란드



R 006-000450

CONTENT

Regulatory Notices	2
A. INTRODUCTION	7
A.1 Thermo Scientific E1-ClipTip Pipette Models	8
A.1.1 Thermo Scientific E1-ClipTip Model Selection	9
A.2 Safety	10
A.2.1 Intended Use	10
A.2.2 Safety Symbols and Markings	10
A.2.3 Safety Precautions	11
A.3 Getting Started	12
A.3.1 Installing the Battery	12
A.3.2 Charging the Pipette	13
A.3.3 Using the Power Supply	13
A.3.4 Using the Charging Stand	14
A.3.5 Turning the Pipette On and Off	15
A.3.6 Power Saving	15
B. PIPETTE OVERVIEW	16
B.1 Components	16
B.2 Keypad and Operation Keys	17
B.3 Rotating Display	19
B.4 ClipTip Interface and Tip Attachment	19
B.4.1 ClipTip 96-format Tips	19
B.4.2 ClipTip 384-format Tips	20
B.4.3 Tip Ejection	20
B.5 Adjustable Tip Spacing	21
B.5.1 To Set the Stop Buttons to Match the Application	22
B.5.2 Use of the Adjustable Tip Spacing	23
C. RECOMMENDATIONS FOR ACCURATE PIPETTING	24
D. PROGRAMMING AND OPERATION	26
D.1 User Interface Overview	26
D.1.1 Introduction to Pipetting View	28
D.1.2 Volume Adjustment	29
D.1.3 Pipetting Speed Adjustment	30
D.2 Pipetting Functions	31
D.2.1 Matrix Function	31
D.2.1.1 Creating a new sequence	31
D.2.1.2 Using the mode	32
D.2.1.3 Editing an existing program	32
D.2.1.4 Save a created Matrix program	32
D.2.1.5 Available Steps	33
D.2.1.5.1 Fill – Filling the tip with liquid	33
D.2.1.5.2 Dispense – Dispensing liquid	34
D.2.1.5.3 Multi – Repeated dispensing of the same volume	35
D.2.1.5.4 Purge – Emptying the tip	35
D.2.1.5.5 Mix – Mixing by pipetting a selected volume	35

D.2.1.5.6 Air gap – a selected volume of air used to separate two liquids	36
D.2.1.5.7 Auto – Repeated dispensing of the same volume on defined time intervals.	36
D.2.1.5.8 Timer – Selected time before the next step can be performed.	37
D.2.1.5.9 Note text – a note text (e.g. a reminder) can be added	37
D.2.1.5.10 Tip eject – Ejection of the tips	37
D.2.1.5.11 Loop step – repeat selected steps for the desired amount of cycles	37
D.2.2 Presets Function	39
D.2.2.1 Forward	39
D.2.2.2 Stepper (Multi dispensing)	40
D.2.2.3 Reverse.	41
D.2.2.4 Repetitive	41
D.2.2.5 Dilute	42
D.2.2.6 Forward + Mix	44
D.2.2.7 Dilute + Mix	45
D.2.2.8 Manual	47
D.2.3 Programs Function.	48
D.3 Supporting Functions	50
D.3.1 My Pipette	50
D.3.1.1 Pipette Name	50
D.3.1.2 Shortcuts	51
D.3.1.3 Organize Icons	52
D.3.1.4 Password Protection	53
D.3.1.4.1 Setting the password	53
D.3.1.4.2 Protecting/Unprotecting items	54
D.3.1.4.3 Removing the Password protection	55
D.3.1.5 User Profiles.	56
D.3.1.6 Thermo Fisher Cloud	56
D.3.2 Settings	57
D.3.2.1 Sounds	57
D.3.2.2 Connections	58
D.3.2.3 Calibrate.	58
D.3.2.4 Calibration Tracker.	58
D.3.2.5 Service Tracker.	59
D.3.2.6 Product Information	60
D.3.2.7 Date and Time	60
D.3.2.8 Recovery.	60
D.3.2.9 Connect Piston	61
D.4 Power Function	61
D.5 Application Examples	62

E. CALIBRATION AND ADJUSTMENT 70

E.1 Terminology	70
E.2 Factory Calibration	70
E.3 Responsibilities of the User	71
E.4 Performing the Calibration	71
E.4.1 Device Requirements and Test Conditions	71
E.4.2 Procedure	72
E.4.3 Calculation Formulas	73
E.4.3.1 Volume Calculation.	73

E.4.3.2 Inaccuracy	73
E.4.3.3 Imprecision	74
E.5 Adjustment	74
E.5.1 Changing Default Calibration Setting	74
E.5.2 Creating Special Adjustments	76
E.5.3 Editing Special Adjustments	77
E.5.4 Deleting a Stored Adjustment Setting	77
F. TROUBLESHOOTING	78
G. MAINTENANCE	82
G.1 Regular and Preventive Maintenance	82
G.2 Replacing Tip Fitting and Sealing Ring(s)	83
G.3 Disassembly and Assembly	85
G.3.1 Single Channel Pipettes – Disassembly	85
G.3.2 Single Channel Pipettes – Cleaning	85
G.3.3 Single Channel Pipettes – Assembly	86
G.3.4 Multi Channel Pipettes	87
G.4 Decontamination Procedure	88
G.5 Autoclaving	88
G.6 Disposal of Materials	89
G.6.1 Disposal of the Materials	89
G.6.2 Disposal of the Pipette	90
G.7 Spare Parts	90
H. TECHNICAL DATA	91
I. WARRANTY	93
J. TECHNICAL SERVICE	94
J.1 Packing for Service	94

A. INTRODUCTION

Congratulations on purchasing a Thermo Scientific E1-ClipTip Electronic Pipette!

The Thermo Scientific™ E1-ClipTip™ is a general purpose electronic micropipette that operates on the air-displacement principle. Its intended use is for aspirating and dispensing liquids. The E1-ClipTip operates only with Thermo Scientific™ ClipTip™ pipette tips.

Notice the difference with the E1-ClipTip Electronic Pipette

Ideal experience even for complex protocols

When combined with the secure, interlocking ClipTip technology*, the electronic pipetting action and flexible user interface, the E1-ClipTip Pipetting System provides a premium pipetting experience for even the most complex protocols.

Pipetting functions for the E1-ClipTip pipette can also be programmed via My Pipette Creator App in the Thermo Fisher Cloud for increased efficiency and program transfer between different E1-ClipTip pipettes. For more information, go to <http://www.thermofisher.com/mypipette>.

Electronic operation helps you enjoy pipetting again

The E1-ClipTip Pipette combines interlocking ClipTip technology with electronic tip ejection and index finger pipetting action, helping to reduce pipetting, tip attachment and ejection forces. This makes pipetting a more comfortable, safe and enjoyable experience.

Perfect fit for sample transfers between different lab formats

One pipette: the E1-ClipTip Equalizer allows you to transfer samples between a variety of lab formats, where only traditional single-channel pipettes would have been suitable in the past. Adaptable tip spacing allows you to set the distance between tips simply by sliding the scale to expand and contract to the desired setting. This means fewer repetitions for multiple applications.

Ideal operation for multiple users and environments

The E1-ClipTip provides simple and fast operation with increased user flexibility. It is possible to create multiple user profiles with personalized settings and own programs for E1-ClipTip pipettes. Users have complete control to set personalized functions for their applications, and utilize optional password protection. This is ideal for multi-user environments so you can avoid unnecessary editing and scrolling through submenus.

Pipette for multiple applications

Choose from single channels, 8-16 channel multichannels, or 6-12-channel adjustable tip spacing multichannel pipettes within the volume range of 0.5-1250 µl. 384 format E1-ClipTip pipettes are ideal for 384-microplate applications.

Flexible re-charging

You can decide whether to use either a charging stand or a plug. Each E1-ClipTip pipette is shipped with a universal wall power plug. The charging stand allows safe storage while ensuring that the E1-ClipTip is always charged when you need it.

Two-year extended warranty

The E1-ClipTip pipette is guaranteed to be free of defects in material and workmanship for a period of two years from the date of purchase. A two-year warranty applies for pipettes that have been registered, while one-year warranty to non-registered ones. Visit www.thermoscientific.com/pipettewarranty to register the pipette and for more information.

* Utilized in all 96-format E1-ClipTip pipettes except 0.5-12.5 µl.



Using this Manual

- ▶ **Read the User Manual before using the device (pipette and tip) for the first time.**
- ▶ **Please check the User Manual if needed.**

Package

1. E1-ClipTip Pipette
2. Universal charger
3. Service tool A (**1062800**)
4. Service tool B (**1062500**) ***not included in multichannel pipettes**
5. Tip Fitting tool C (**0300070**) ***not included in 384 multichannel pipettes**
6. Instructions for Use
7. Tip Fitting sealing-ring ***not included in 384 pipettes**
8. Li-ion battery
9. USB cable

Remove the content from the package and check that all items listed above are included. Inspect for possible shipping damage. Make sure that the pipette has the desired volume range and that the voltage of the charger is correct.

A.1 Thermo Scientific E1-ClipTip Pipette Models



Single Channel







Multichannel













Equalizer Adjustable Tip Spacing Multichannel

A.1.1 Thermo Scientific E1-ClipTip Model Selection











E1-ClipTip Single Channel models

Cat.no. Standard	Cat.no. Bluetooth model	Channels	Volume Range (ul)	Calibration Range (ul)*	Color Code	Compatible ClipTip
4670000	4670000BT	1	0.5-12.5	1.25-12.5		ClipTip 12.5, 12.5 Ext
4670020	4670020BT	1	2-125	12.5-125		ClipTip 200
4670030	4670030BT	1	10-300	30-300		ClipTip 300, 300 Ext
4670040	4670040BT	1	15-1250	125-1250		ClipTip 1250

E1-ClipTip Multichannel models

Cat.no. Standard	Cat.no. Bluetooth model	Channels	Format	Volume Range (ul)	Calibration Range (ul)*	Color Code	Compatible ClipTip
4671000	4671000BT	8	96	0.5-12.5	1.25-12.5		ClipTip 12.5, 12.5 Ext
4671040	4671040BT	8	96	2-125	12.5-125		ClipTip 200
4671070	4671070BT	8	96	10-300	30-300		ClipTip 300, 300 Ext
4671100	4671100BT	8	96	15-1250	125-1250		ClipTip 1250
4671010	4671010BT	12	96	0.5-12.5	1.25-12.5		ClipTip 12.5, 12.5 Ext
4671050	4671050BT	12	96	2-125	12.5-125		ClipTip 200
4671080	4671080BT	12	96	10-300	30-300		ClipTip 300, 300 Ext
4671090	4671090BT	12	96	30-850	85-850		ClipTip 1000
4671020	4671020BT	16	384	0.5-12.5	1.25-12.5		ClipTip 384 12.5, 12.5 Ext
4671030	4671030BT	16	384	1-30	3-30		ClipTip 384 30
4671060	4671060BT	16	384	2-125	12.5-125		ClipTip 384 125

E1-ClipTip Equalizer Adjustable Tip Spacing Multichannel models

Cat.no. Standard	Cat.no. Bluetooth model	Channels	Tip Spacing (mm)	Volume Range (ul)	Calibration Range (ul)*	Color Code	Compatible ClipTip
4672050	4672050BT	8	9 - 14.2	2-125	12.5-125		ClipTip 200
4672080	4672080BT	8	9 - 14.2	10-300	30-300		ClipTip 300, 300 Ext
4672090	4672090BT	6	9 - 19.8	15-1250	125-1250		ClipTip 1250
4672100	4672100BT	8	9 - 14.2	15-1250	125-1250		ClipTip 1250
4672010	4672010BT	8	4.5 - 14.2	0.5-12.5	1.25-12.5		ClipTip 384 12.5, 12.5 Ext
4672030	4672030BT	8	4.5 - 14.2	1-30	3-30		ClipTip 384 30
4672060	4672060BT	8	4.5 - 14.2	2-125	12.5-125		ClipTip 384 125
4672020	4672020BT	12	4.5 - 9	0.5-12.5	1.25-12.5		ClipTip 384 12.5, 12.5 Ext
4672040	4672040BT	12	4.5 - 9	1-30	3-30		ClipTip 384 30
4672070	4672070BT	12	4.5 - 9	2-125	12.5-125		ClipTip 384 125

*Calibration Range according to ISO8655 standards

A.2 Safety **A.2.1 Intended Use**

The intended use of the device is to transfer liquids with different properties accurately and reliably. The E1-ClipTip pipette and ClipTip tips are designed to be part of an analyzing system for an end user, who is responsible for the validation of the system to enable production of reliable and safe results. The performance related cautions in Chapter: [E: CALIBRATION AND ADJUSTMENT](#) should be checked.

If the pipetting performance is critical for the outcome of the specific application, the result has to be assured with an alternative test, and if this is not an option, by duplicate testing. The possibility of an incorrect volume delivery during pipetting cannot be completely mitigated. This device is to be used by trained personnel that have adequate laboratory skills. Use of the device for pipetting any liquid to be injected into the human body is not permitted.

A.2.2 Safety Symbols and Markings

These symbols are intended to draw your attention to particularly important pieces of information and alert you to the presence of hazards as indicated.



Caution Risk of damage to the instrument, other equipment or loss of performance or function in a specific application.



Warning Risk of injury to the user(s).



Warning Risk of electric shock.



Warning Biohazard risk.



WEEE (Waste Electrical and Electronic Equipment) symbol indicates that this product should not be disposed of in unsorted municipal waste. Follow local municipal waste ordinances for proper disposal provisions to reduce the environmental impact of WEEE. This instrument meets European requirement WEEE Directive 2012/19/EU.



Note Marks a hint, important information that is useful in the optimum operation of the system, or an item of interest.

A.2.3 Safety Precautions

The following safety precautions provide important information intended to prevent personal injury to the operator and/or others, and damage to the E1-ClipTip pipette.



Warning Follow general instructions for hazard prevention and safety instructions; e.g., wear protective clothing, eye protection, and gloves.



Warning Follow the ergonomic guidelines for laboratory work to minimize the risk of repetitive strain injury (RSI), e.g., the Good Laboratory Pipetting Guide available at www.thermoscientific.com/glp.



Warning Follow the safety instructions and general laboratory practice for use and waste disposal of hazardous material e.g., radioactive and potentially infectious.



Warning Ensure that the power transformer is connected to a power receptacle that provides the voltage and current specified in this user manual. Use of an incompatible power receptacle can cause shock and fire hazard.



Warning Follow the E1-ClipTip pipette instructions presented in this user manual in Chapter: [H: TECHNICAL DATA](#). Failure to follow the instructions may cause a safety risk.



Warning Do not immerse the unit in liquid and do not clean the upper part of the pipette by spraying. Fluid seepage can damage internal components and may cause a safety risk.



Warning Incorrect handling of the battery or pipette may cause personal injury. Do not drop the battery. Do not expose the battery to any kind of mechanical stress or extreme temperatures: above 60°C (45°C when charging) or under 0°C.



Warning An old battery can cause the pipette to malfunction and may cause a safety risk (thermal runaway). We recommend that you change the battery every two years. If the battery's recharging interval decreases significantly, the battery should also be changed. It is recommended to charge the pipette every two months even if the pipette is not used daily.



Warning The E1-ClipTip pipette contains a Li-ion battery and a potential malfunction of the battery (short circuit, mechanical damage, overheating, etc.) may cause explosion. Do not touch a leaking battery directly. Do not use the battery in areas with abundant static electricity, otherwise the safety devices may be damaged, creating the potential for hazardous situations.



Warning Do not use a battery that causes the following notifications "battery failure 2 or 3" on the pipette display. Such a battery may cause a potential safety risk. For more instructions, see Chapter: [F: TROUBLESHOOTING](#).



Caution Use only the power transformer supplied by Thermo Fisher Scientific. Use of an incompatible power transformer can damage the pipette.



Caution Always turn off the power and unplug the power transformer before cleaning the exterior. Fluid seepage can damage internal components.



Caution Do not autoclave the entire unit. Extreme heat can damage the display and other electronic components.



Caution Do not clean the keypad with bleach solution or other solvents. Caustic cleaning solutions can damage the keypad.



Note Do not hold the pipette horizontally or upside down when there is liquid inside the tip: The sample liquid may enter the pipette, which may affect pipetting performance and impair the pipette.



Note Refer to section [G.5 Autoclaving](#) for autoclaving specific portions of the pipette, or call Thermo Fisher Scientific Technical Service for instructions.

A.3 Getting Started **A.3.1 Installing the Battery**

The E1-ClipTip pipette is delivered with a detached battery. Install the battery as follows:



Warning Incorrect handling of the battery or pipette may cause personal injury. Do not drop the battery. Do not expose the battery to any kind of mechanical stress or extreme temperatures: above 60°C (45°C when charging) or under 0°C.

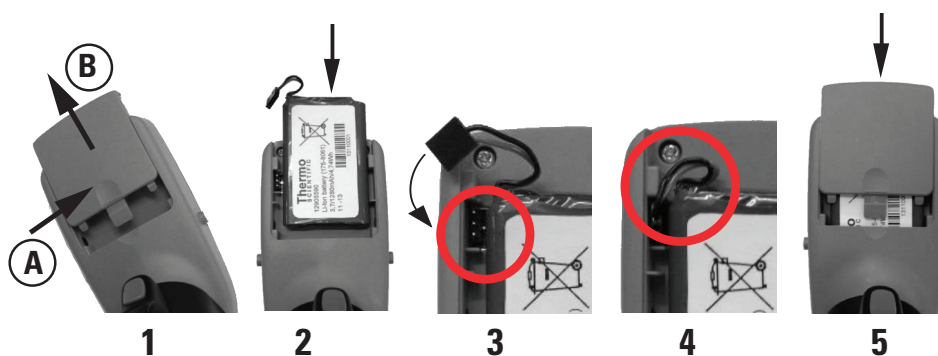

1. Open the battery lid (press (A) and slide (B)).
2. Slide in the battery with the label side visible.
3. Connect the battery connector. Note that the connector can be attached in two different orientations, both of which are acceptable.
4. Check that the battery wires are as shown in the picture.
5. Slide back the battery lid as shown in the picture.

A.3.2 Charging the Pipette

The charging time to full capacity is approx. 2 h. An indicator on the LCD display shows the charge level of the battery.

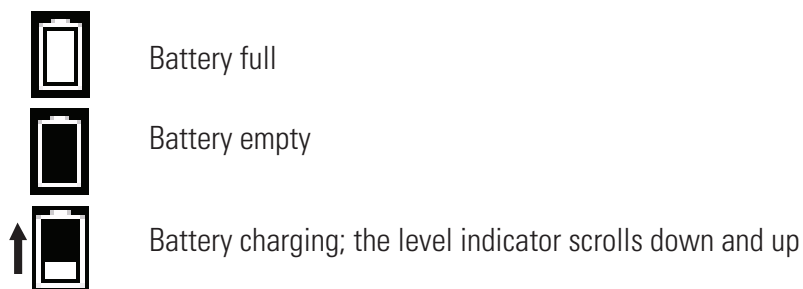

When the indicator shows that the battery is empty, pipetting is no more possible, and the pipette has to be recharged. To extend the battery life cycle, it is recommended to charge the pipette every two months even if the pipette is not used daily. A typical E1-ClipTip battery lasts for around 300 charging cycles.



Warning An old battery can cause the pipette to malfunction and may cause a safety risk (thermal runaway). It is recommended that you change the battery every two years. If the battery's recharging interval decreases significantly, the battery should also be changed. It is recommended to charge the pipette every two months even if the pipette is not used daily.

A.3.3 Using the Power Supply

Insert the country specific power plug adapter into the power supply unit. The power supply unit is marked with number 5 in the picture on the right.

Power plug adapters:

1. Australia
2. Europe
3. United Kingdom
4. USA / Japan



Connect the lead of the charger to the socket on top of the display. Then connect the charger to an AC wall socket. You can use the pipette while the charger is connected.



Caution The charger's plug must be inserted in to a socket that is easy to reach and from which it can be easily unplugged in case of emergency.



Warning Use only the original E1-ClipTip charger and battery pack. The pipette battery may be empty when delivered and must be charged before initial use. It is recommended to charge the battery for at least 2.5 h when charged for the first time.



Caution The pipette must be charged at temperatures between 0°C to 45°C. The battery may be damaged if charged at other temperatures. For indoor use only.



Warning Use of incorrect power supply units may result in fatal injuries and damage to the device.



Use of incorrect power supply units may result in overheating, burning, melting, short-circuiting of the E1-ClipTip pipette or similar damage. Only use the supplied power supply unit for charging the pipette. You can recognize the correct power supply by the Thermo Scientific logo and the pipette name on the power supply unit. Do not charge the pipette in a hot location (>45°C).

A.3.4 Using the Charging Stand

Connect the lead of the charger to the socket on the back of the charging stand. Then connect the charger to an AC wall socket. Place the pipette in to the stand as shown in the picture. See also the previous section [A.3.3 Using the Power Supply](#).









Power supply output: 5,0V \approx 3 A



Power supply output: 5,0V \approx 0,8 A







A.3.5 Turning the Pipette On and Off

After the battery is charged, the device can be powered up:

1. Press one of the selection keys  ,  or arrow keys  ,  ,  ,  below the display for more than 1 s. Note that tip ejection buttons are not available. See section [B.2 Keypad and Operation Keys](#) for more information about the keypad.
2. If the battery was just installed, then you need to set the date and time to the pipette. Follow the instructions on the display.
3. Press the trigger switch to initialize home positioning. See section [B.2](#) for more information about control buttons.
4. The pipette will show the main menu and is ready for use.
5. The pipette can be turned off by selecting the "Power" icon from the main menu.



A.3.6 Power Saving

If the pipette is not used for a minute, the brightness of the display is decreased and after 10 minutes the screen saver mode is entered. Exit the screen saver by pressing one of the selection keys  ,  or arrow keys  ,  ,  ,  . Home positioning needs to be initialized again after screen saving and is done by pressing the trigger switch. If the pipette is not used for an hour, it will automatically turn itself off.

B. PIPETTE OVERVIEW

B.1 Components



1. Connector Socket

For connecting the power supply.

2. Battery Case

Case for the Li-ion battery. See section [A.3.1](#) for installation.

3. Display

LCD backlit color display.

4. Charging Pins

Charging pins to connect the pipette to the charging stand. See section [A.3.4](#).

5. Keypad

For interacting with the pipette user interface. See section [B.2](#).

6. Tip Ejection Keys*

For ejecting pipette tips.

7. Pipetting trigger*

Trigger button to operate the piston movement. See section [B.2](#).

8. Finger Hook

Adjustable finger hook. See section [B.2](#).

9. Tip Ejector

10. Tip Fitting

11. ClipTip

See section [B.4](#).



1. Spacing Set Buttons*

To set the tip spacing movement range within the scale. See section [B.5](#).

2. Spacing Adjuster

To change the space between the tips within the scale. See section [B.5](#).

***Color coded parts**

B.2 Keypad and Operation Keys

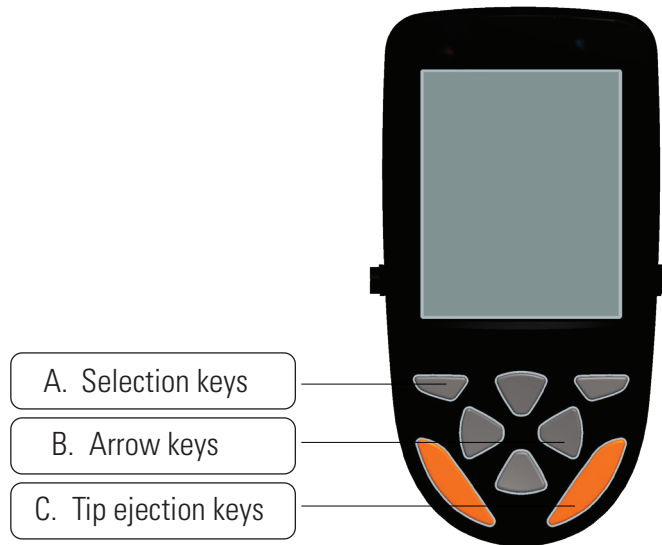

Picture B1. E1-ClipTip keypad

A. Selection keys: The selection keys are used for activating modes and confirming selections.

B. Arrow keys: The Up and Down arrow keys are used to move up and down in the user interface. The Left and Right arrow keys are used to edit settings, such as volume and speed changes.

C. Tip ejection keys: The tip ejection keys are used to eject the tips from the pipette electronically. There are two ejection keys to ensure convenient use for both right and left handed users. When the pipette is ejecting tips the ejecting tips icon is shown on the display.



The tip ejections keys are active only when the entire pipetting cycle is completed to prevent accidental tip ejection during pipetting. The keys are always inactive during the pipetting cycle.

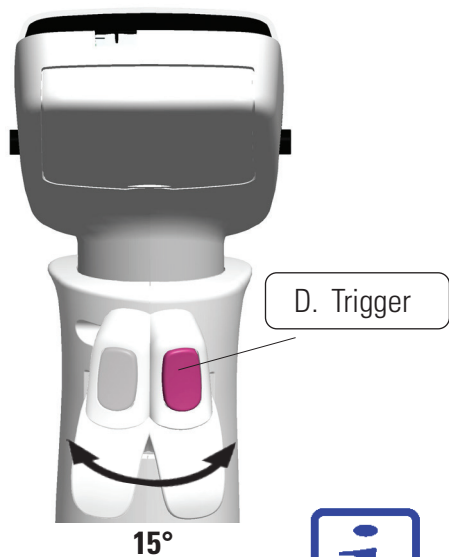

D. Trigger: The index finger operated trigger is used to aspirate and dispense liquid. It is also used to initiate mixing. The trigger and finger rest can be rotated 15 degrees in both directions to ensure an optimal pipetting position.

Dispensing into air

1. Press the trigger shortly to dispense the liquid (Picture B2).
2. The pipette returns to the ready position.



Note When using small volumes and certain liquid types, it is recommended to keep the trigger pressed until all liquid has been dispensed from the tip.



Note After dispensing, it is recommended to touch the tip(s) against the edge of the reservoir to remove possible remaining liquid on the outside surface of the tip.

Dispensing into liquid

1. Put the tip into the liquid (Picture B3).
2. Press the trigger to dispense the liquid and keep the trigger pressed until the tip is withdrawn from the liquid.
3. Lift the tip from the liquid and release the trigger.
4. The pipette returns to the ready position.

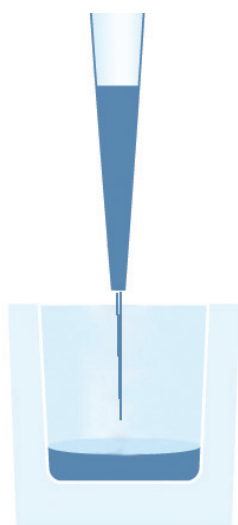

Picture B2.

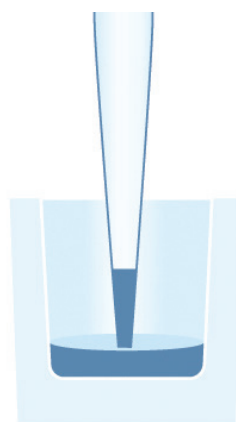

Picture B3.

B.3 Rotating Display

The E1-ClipTip features a rotating full color display, ensuring optimal visibility in different working environments. The display rotates 30 degrees in both directions from the center position. The rotating angle can be adjusted by turning the display left or right.

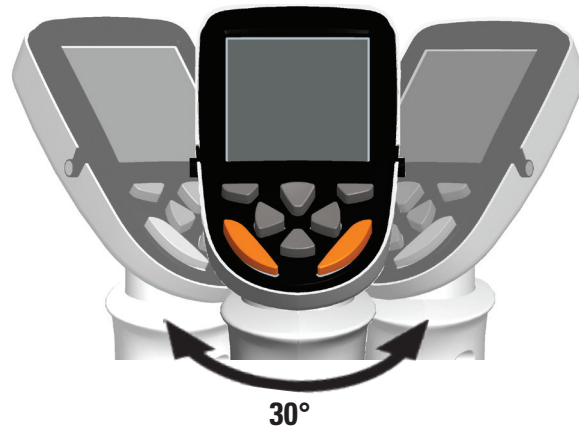

Picture B4. Rotating display

B.4 ClipTip Interface and Tip Attachment

B.4.1 ClipTip 96-format Tips

The ClipTip interlock technology is based on flexible clips around the top of the tip. During attachment the tip fitting opens the clips, and the clips pass over the fitting flange and return to closed positions. The clips lock the tip behind the flange creating a complete seal with the sealing ring. The lock prevents the tip from loosening, or falling off during pipetting or touch-off.

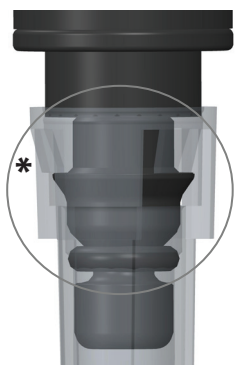

Note The ClipTip 12.5 µl design is similar to the ClipTip 384 tip design.

Tip Attachment

1. Always use tip spacing at the closed position when attaching tips from a rack.
2. To attach the tip, guide the pipette into a ClipTip in a rack and lightly apply force until the tip is attached. A delicate 'click' sound will indicate that the tip is attached. The tip is attached when the clips are locked into the tip fitting.
3. Lift the pipette.
4. If the tip is not attached, repeat Steps 1 and 2.

Picture B5. ClipTip 96-format Tips



Note For optimal tip attachment and ejection, using a moderate amount of tip attachment force without rocking the pipette is recommended.

Picture B6. Attachment of 96-format tips

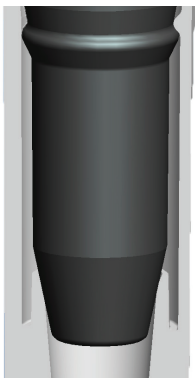

Picture B7.
ClipTip 384

B.4.2 ClipTip 384-format Tips

ClipTip 12.5 and all ClipTip 384 tips feature a unique 'snap and lip' mechanism for tip attachment. The tip has small incorporated protrusions that snap on the tip fitting flange, ensuring secure tip attachment with little force. The flexible plastic lip design seals the tip against the tip fitting.

Tip Attachment

1. Always use tip spacing at the closed position when attaching tips from a rack.
2. To attach the tip, guide the pipette into a 384 ClipTip in a rack and press until the tip is attached. The tip is attached when it snaps over the tip fitting flange. Do not use excessive force when attaching the tips as the device requires minimum attachment force.
3. Lift the pipette.
4. If the tip is not attached, repeat Steps 1 and 2.



Note For optimal attachment with 16-channel pipettes, a moderate tip attachment force with gentle rocking is recommended.

B.4.3 Tip Ejection

All E1-ClipTip pipettes utilize an electronic tip ejection. Two color-coded buttons ensure optimal tip ejection operation for both left- and right-handed users (see section [B.2](#)).



Note The tip ejection function is prevented whenever there is liquid inside the tip to avoid accidental tip ejection during pipetting.



Caution Always eject the tips into an appropriate waste container. Do not eject tips towards another person.

B.5 Adjustable Tip Spacing

The E1-ClipTip Equalizer pipette allows one to change the tip-to-tip spacing. This enables pipetting into or between vessels of varying center-to-center configurations.

E1-ClipTip Equalizer Adjustable Tip Spacing Multichannel models

Cat.No.	Channels	Tip Spacing (mm)	Volume Range (µl)	Equalizer Window				Color Code	Compatible ClipTip
				384	96	48 MCT	24 Tube		
4672050, 4672050BT*	8	9 - 14.2	2.0-125		●	●		●	ClipTip 200
4672080, 4672080BT*	8	9 - 14.2	10.0-300		●	●		●	ClipTip 300, 300 Ext
4672090, 4672090BT*	6	9 - 19.8	15-1250		●	●	●	●	ClipTip 1250
4672100, 4672100BT*	8	9 - 14.2	15-1250		●	●		●	ClipTip 1250
4672010, 4672010BT*	8	4.5 - 14.2	0.5-12.5	●	●	●		●	ClipTip 384 12.5, 12.5 Ext
4672030, 4672030BT*	8	4.5 - 14.2	1.0-30	●	●	●		●	ClipTip 384 30
4672060, 4672060BT*	8	4.5 - 14.2	2.0-125	●	●	●		●	ClipTip 384 125
4672020, 4672020BT*	12	4.5 - 9	0.5-12.5	●	●			●	ClipTip 384 12.5, 12.5 Ext
4672040, 4672040BT*	12	4.5 - 9	1.0-30	●	●			●	ClipTip 384 30
4672070, 4672070BT*	12	4.5 - 9	2.0-125	●	●			●	ClipTip 384 125

* Bluetooth Model

Equalizer Window	Spacing (mm)	Application
384	4.5	384-well microplates 384 PCR plates Agarose gels
96	9	96-well microplates Deepwell blocks
48 MCT	13	48-well microplates Deepwell blocks Microcentrifuge tube racks
24 Tube	18	Test tube racks 24-well microplates

B.5.1 To Set the Stop Buttons to Match the Application

There are three ways to set the stop buttons in the correct positions for application when using the adjustable tip spacing.

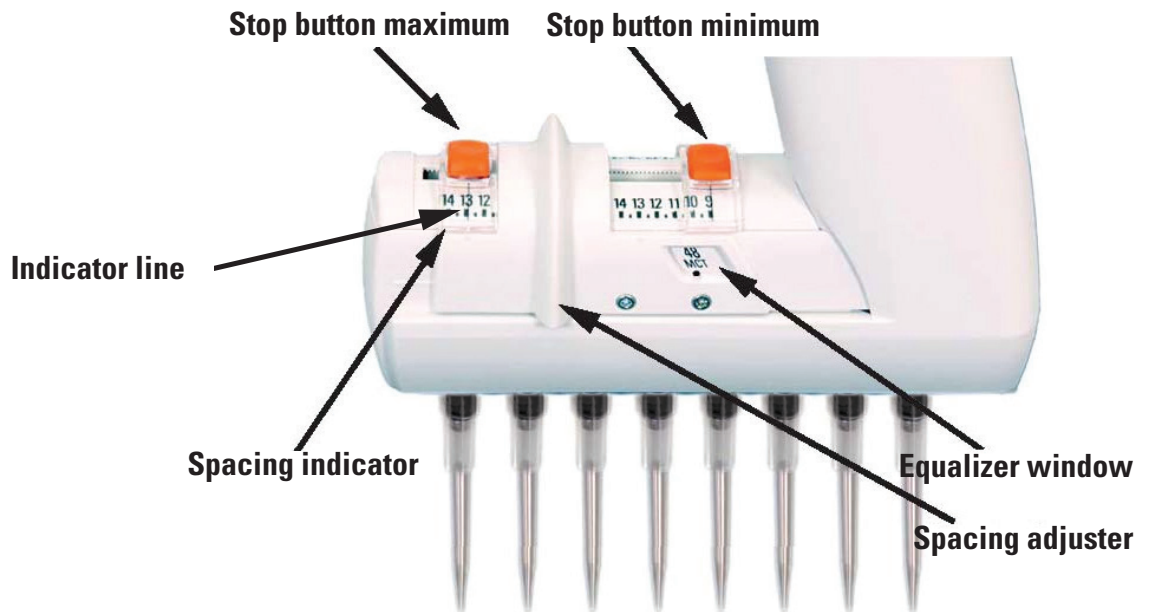

Using the millimeter scale

When the user knows the tip spacing of the application in millimeter range,

1. Depress the stop buttons while moving them along the scale.
2. Set the Stop button minimum and maximum along the spacing indicator scale. Match the Indicator line with the desired millimeter spacing.
3. Release the stop buttons to lock the positions for use.

Using application formats

We recommend using the Equalizer window when the application formats are known.

1. Depress the stop buttons while moving them to the outmost positions.
2. Slide the Spacing adjuster to view the alternatives in the Equalizer window.
3. Depress the Stop button minimum and move it to the edge of the Spacing adjuster with the selected format (min.) in the Equalizer window with the marker dot visible.
4. Release the stop button to lock the positions for use.
5. Depress the Stop button maximum and move it to the other edge of the Spacing adjuster with the selected format (max.) in the Equalizer window with the marker dot visible.
6. Release the stop button to lock the positions for use.



Picture B8.

Using an unknown tip spacing

If the tip spacing of the application is unknown, for example, when there is a need for aligning the tips to the vessel or tip rack, etc.,

1. Depress the stop buttons while moving them to the outmost positions.
2. Attach the tips.
3. Slide the tips into the desired minimum position using the Spacing adjuster.
4. Depress the Stop button minimum and move it to the edge of the Spacing adjuster.
5. Release the stop button to lock the positions for use.
6. Slide the tips into the desired maximum position using the Spacing adjuster.
7. Depress the Stop button maximum and move it to the other edge of the Spacing adjuster.
8. Release the stop button to lock the positions for use.

B.5.2 Use of the Adjustable Tip Spacing

The following instructions are examples of how to use the adjustable tip spacing. Note that the amount and sequence of used tip spacing positions can vary according to the requirements of the application.



Note Always use the minimum tip spacing position when attaching tips from a rack.



Picture B9.

The stop button positions are ready set according to the instructions in section 5.1.

1. Slide the Spacing adjuster to the edge of the Stop button minimum.
2. Attach the tips from a rack.
3. Slide the Spacing adjuster to the edge of the Stop button maximum.
4. Press the pipetting **trigger** to fill the tips with liquid, for example, from Microcentrifuge tubes (Picture B8).
5. Slide the Spacing adjuster to the edge of the Stop button minimum.
6. Press the pipetting **trigger** to dispense the liquid, for example, into a 96-well microplate (Picture B9).

C. RECOMMENDATIONS FOR ACCURATE PIPETTING

For optimal pipetting results we advise you to follow the following:

If possible, make sure that the pipette, tips and liquid are at the same temperature.

Pre-rinsing the tip three to five times with the liquid to be pipetted improves accuracy and precision.

Pre-rinsing is especially important when pipetting volatile compounds since it prevents liquid from dripping out of the tip.

During aspiration, it is recommended to wait until the liquid movement in the tip(s) stops before withdrawing the tip from the liquid.

After aspiration and dispensing, it is recommended to touch the tip(s) against the edge of the reservoir to remove any possible remaining liquid on the outside surface of the tip.

Samples should be pipetted in the same manner, aspiration depth, pipetting angle (preferably in the upright direction), and dispensing technique (dispensing into air, immersed into liquid, or touching the wall).

Aspiration and dispense at low speeds when working with high viscosity liquids.

The pipette can be adjusted for liquids of a different density or viscosity to improve accuracy and precision. See Chapter E: [CALIBRATION AND ADJUSTMENT](#) for further information.

To improve pipetting results in multi-dispensing operations (stepper and multi functions), it is recommended to use a pre-step. In the stepper mode, the default setting for the pre-step is "In use".

In step based programs, the user needs to program a separate dispensing step as the pre-step.

Do not clean tips for reuse, as their metrological characteristics will no longer be reliable. Tips are designed for single use only.



Note Pipetting performance cannot be guaranteed if the tip is reused.

Choose only a tip and pipette of matching color. See information on compatibility in section A.1.1.



Note When dispensing into liquid, the trigger should be kept pressed until the tip is withdrawn from the liquid to prevent aspiration of the liquid.



Caution The user should check that the device is resistant to liquids that are intended to be handled. The user should also verify the resistance to the used cleaning methods.

D. PROGRAMMING AND OPERATION

D.1 User Interface Overview

The E1-ClipTip user interface contains icons on the main menu showing six main functions (Picture D1). The main menu appears when the pipette is turned on and also when the pipette is initiated from the power save mode. See the detailed menu map in Picture D2.



Picture D1.

All pipetting actions are included in the Matrix and Presets icons. Matrix and Presets are designed for fast and easy pipetting without saving. The last used parameters will be saved automatically.

The Matrix function uses the step based operating technique. Each pipetting step is entered separately in the sequence in which they will be performed.





Presets includes application based pipetting styles. The pipetting sequence is preset. Only volumes and speeds have to be set.

Storing different kinds of programs can be done under the Programs icon. Thirty programs with specific names and calibrations can be stored.



Note Pipetting functions for the E1-ClipTip pipette can also be programmed with My Pipette Creator App in Thermo Fisher Cloud and then transferred to the E1-ClipTip pipettes. See D.3.1.6

Support functions are divided into three icons: My Pipette, Settings, and Power.

Navigate to the desired icon in the main menu by using the ,  and ,  keys.

Press  (**Select**) to select the icon of interest.

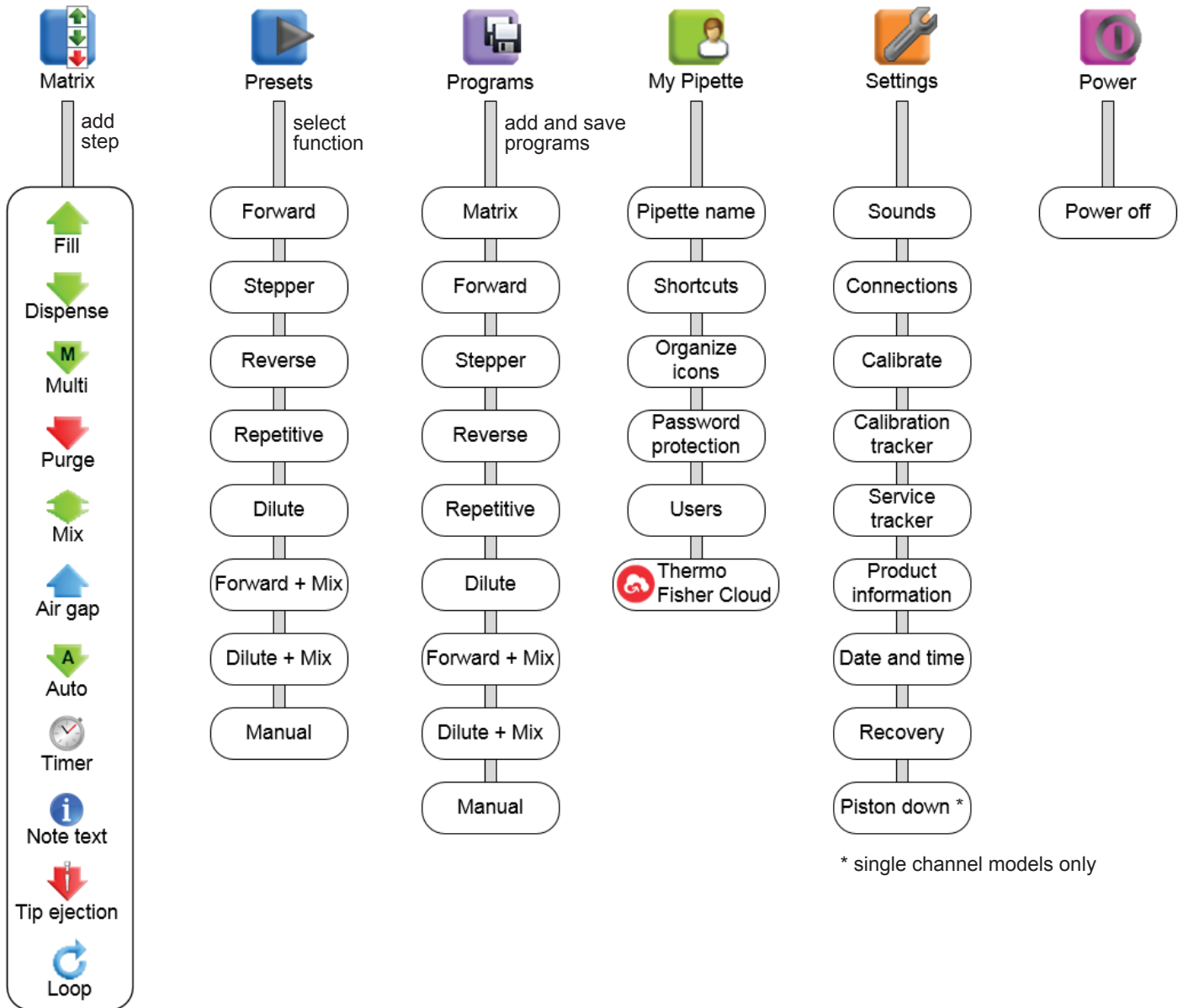

Picture D2. Menu Map

D.1.1 Introduction to Pipetting View

The E1-ClipTip pipette features a simple pipetting view, including all the information needed during the pipetting cycle. The pipetting view can be entered via the Matrix, Presets and Programs icons. A typical pipetting view layout is explained below.

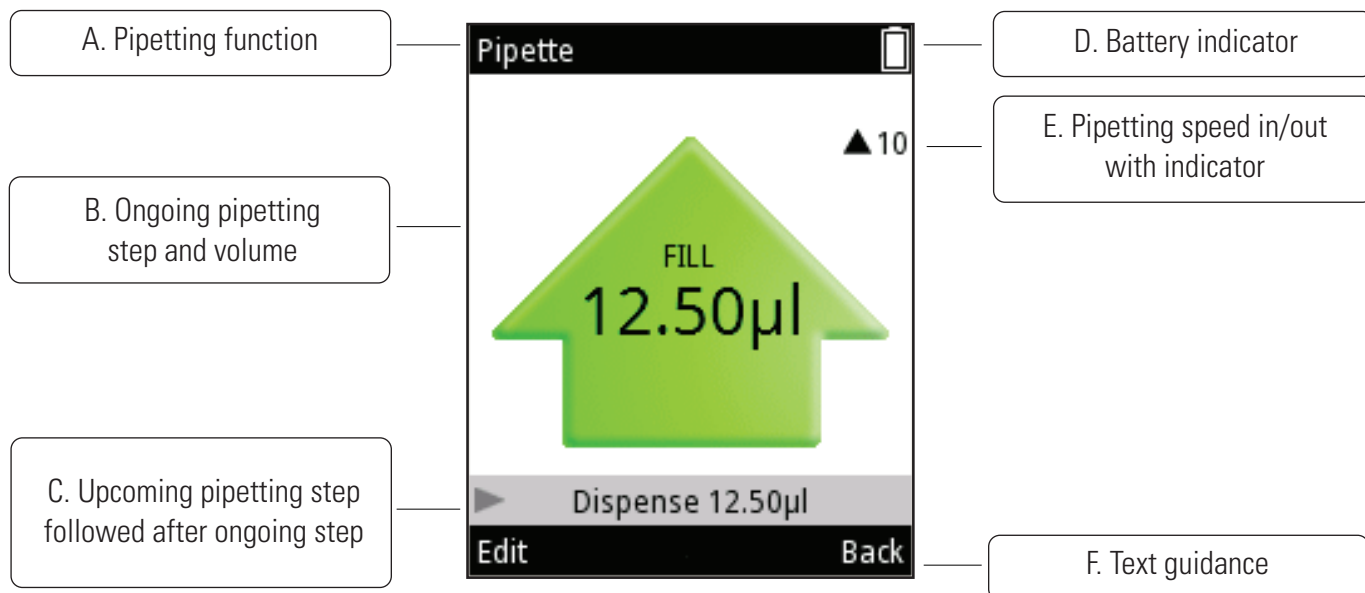

Picture D3. Display layout and functionality

A. Name of the ongoing pipetting function

B. The ongoing pipetting step and the volume. During aspiration the arrow points upwards, and downwards during dispensing. Different arrow types and colors are used to show different functions, such as purge and mixing.

C. Indicates the following pipetting step taking place after the ongoing step.

D. Battery indicator

E. Pipetting speed indicator. The number next to the arrow indicates the present speed setting. The arrow changes direction depending on whether the pipette is aspirating (arrow up) or dispensing (arrow down).







F. Text guidance for both selection keys

D.1.2 Volume Adjustment

The volume adjustment for different pipetting functions in the E1-ClipTip pipette can be done using three different methods.









Method 1.

In this method the volume is adjusted by scrolling through the volume range.

1. The volume can be changed by pressing  (**Edit**) or ,  while in the active pipetting function (Picture D4).
2. The Volume field will be highlighted (Picture D5).
3. Use  to increase the volume and  to decrease the volume. Volume scrolling can be accelerated by keeping the keys pressed.
4. Press  (**Done**) when the changes are ready.

Method 2.

In this method it is possible to adjust the digits of the volume number separately, allowing a quicker setup from a low value to a high one or vice versa, e.g., from '0010' to '1220'.

1. The volume can be changed by pressing  (**Edit**) or ,  while in the active pipetting function (Picture D4).
2. The Volume field will be highlighted (Picture D5).
3. Press  to activate the **Volume editor** (Picture D6).
4. Use  to increase the selected number and  to decrease the number.
5. Use ,  to highlight the next number to be edited.
6. Press  (**Done**) when the changes are ready.

Method 3.

In this method it is possible to select a volume from a recently used volume list. The list is located on the right edge of the Volume editor window. The maximum number of volumes in this list is six.

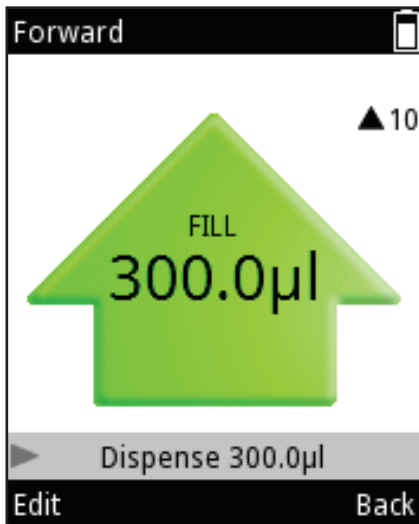

Picture D4.

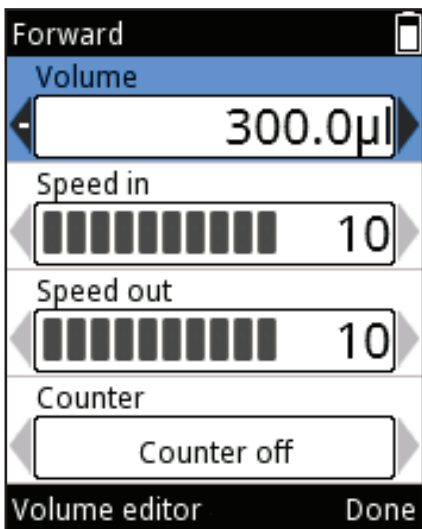

Picture D5.

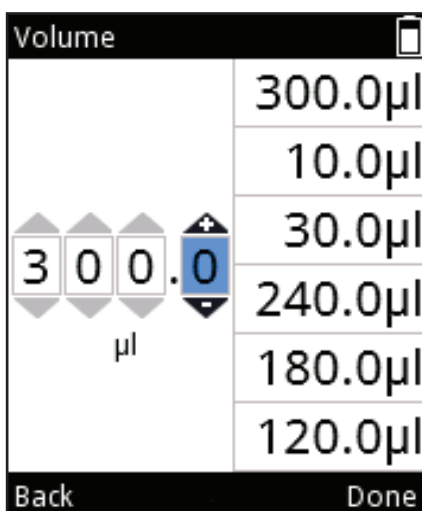

Picture D6.

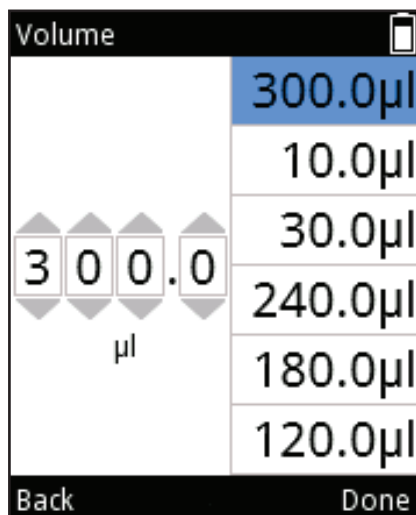

Picture D7.

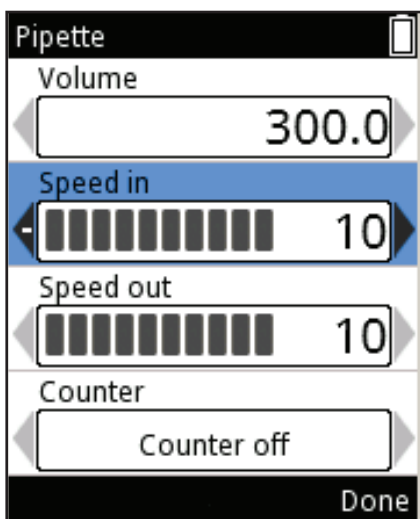

Picture D8.

1. The volume can be changed by pressing (**Edit**) or , , while in the active pipetting function (Picture D4).
2. The Volume field will be highlighted (Picture D5).
3. Press to activate the **Volume editor** (Picture D6).
4. When the last number of the volume is highlighted (Picture D6), use to move into the volume list. The volume at the top of the list will be automatically highlighted (Picture D7). Use , to navigate in the volume list.
5. When the preferred volume is highlighted, press (**Done**) to enter into the basic volume field to continue editing.

D.1.3 Pipetting Speed Adjustment

It is possible to adjust aspiration (speed in) and dispensing (speed out) separately in the E1-ClipTip pipette. There are 10 different speeds available. The speed can be set as a value from 1 (slowest) to 10 (fastest).

The speed is also indicated as a horizontally laid set of bars located next to the speed value. The number of bars is the same as the maximum speed value. Dark bars, starting from the left edge, indicate the current value. The other bars have a lighter color.







1. Press (**Edit**) or , in the pipetting mode view (Picture D4).
2. Use , to highlight the Speed in or Speed out (Picture D8).
3. Use to increase the speed and to decrease the speed.
4. Press (**Done**) when the changes are ready.

D.2 Pipetting Functions

D.2.1 Matrix Function

The Matrix function uses a step-based operating technique. Each pipetting step is entered separately according to the sequence in which they will be performed.

D.2.1.1 Creating a new sequence

1. Select the  (**Matrix**) icon in the main menu. A list of possible steps to be added to the pipetting sequence appears on display (Picture D9).
2. Select the first step to be entered to the sequence by using ,  and by pressing  (**Select**). The selected step's editing window appears (Picture D10).
3. The step-specific parameters can be edited, the volume, speed, etc. Press  (**Done**) when the changes are ready.
4. To add an additional step to the pipetting sequence, highlight the **Add new step** row (Picture D11) and press  (**Add**).
5. Press  (**Done**) when all the steps are added to the pipetting sequence and the program is ready for use.



Picture D9.

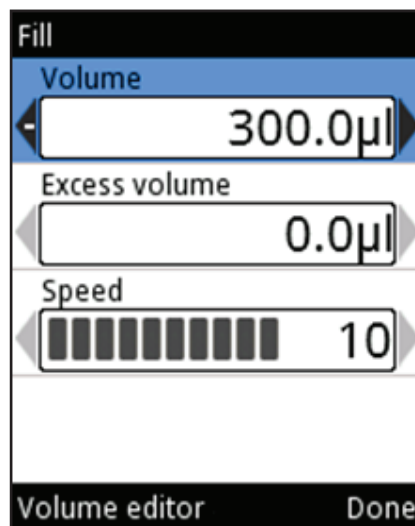

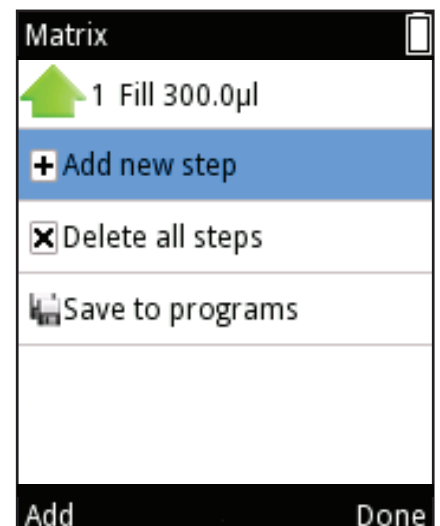

Picture D10.



Picture D11.

D.2.1.2 Using the mode



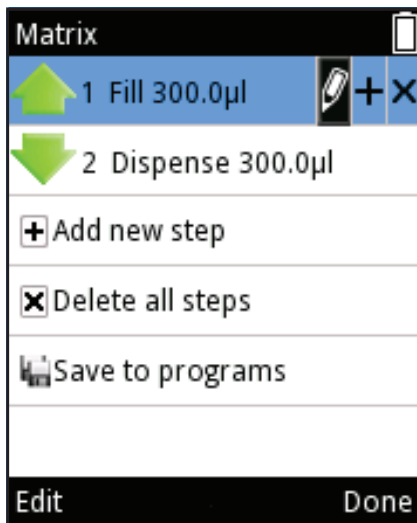









1. Select the  (**Matrix**) icon in the main menu. The pipetting mode view appears on the display.
2. Place the tip(s) under the liquid surface and press the **trigger** to aspirate the liquid.
3. Continue until all the selected steps have been completed.
4. Continue dispensing or press  (**Back**) to go back to the main menu.





Picture D12.

D.2.1.3 Editing an existing program

For each step it is possible to (Picture D12):

1. Edit step parameters: Use ,  to highlight the  icon and press  (**Edit**). Note that the tip ejection step cannot be edited.
2. Add a step above another step: Use ,  to highlight the  icon and press  (**Add above**).
3. Delete a step: Use ,  to highlight the  icon and press  (**Delete**).

All steps in the sequence can be deleted by highlighting the row  **Delete all steps** and pressing  (**Delete**).

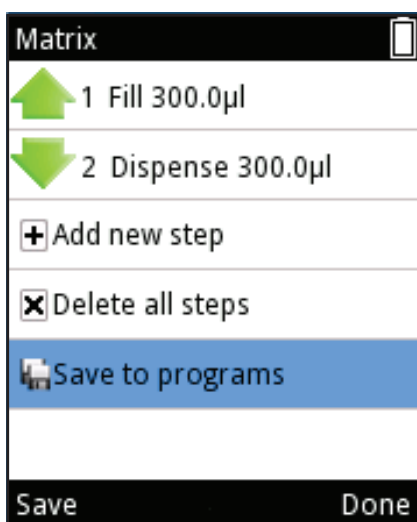

Picture D13.

D.2.1.4 Save a created Matrix program

You can save a created Matrix program by highlighting the row  **Save to programs** and pressing  (**Save**). See Picture D13.

The new program is given a default name that can be edited. See Section [D.3.1.1 Pipette Name](#).

The name and the program are stored by pressing  (**Done**). The stored program can be found under the Programs icon. See Section [D.2.3 Programs Function](#).



Picture D14



D.2.1.5 Available Steps

The maximum amount of steps that can be added to one sequence is 60.

Steps can be added by selecting the **Add new step** or **(Add above)**.

A lists of steps (Picture D14) is opened and a step can be selected by scrolling and pressing **(Select)**.

See detailed descriptions of the available steps in the following pages.

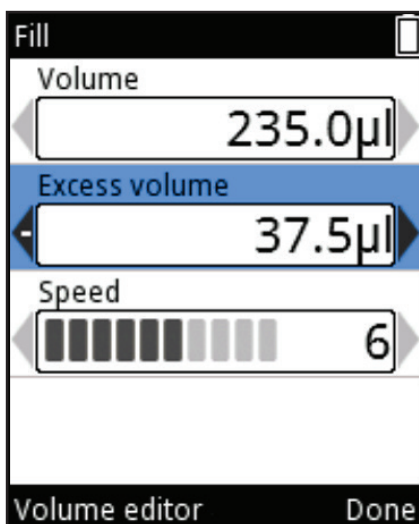

Picture D15

D.2.1.5.1 Fill – Filling the tip with liquid

Change the volume using , or the **Volume editor** (section D.1.2).

Scroll to **Excess volume** and change the value using , or the **Volume editor** (section D.1.2). See below for detailed information about using the Excess volume.

Scroll to **Speed** and change the value using , .

Press **(Done)** when the changes are ready.

See also the example **Sample Transfers** in the chapter [D.5 Application Examples](#).

The Fill Step in Reverse Pipetting and Serial Dispensing

Certain pipetting techniques such as Reverse Pipetting and Serial Dispensing (stepping) use an excess volume in addition to the actual set volume.

In Serial Dispensing, the excess volume functions as a reservoir that evens out the sequential volumes and ensures that there is enough liquid to perform all the steps. In Reverse Pipetting, the excess volume also prevents air from passing through the tip orifice, which reduces the possibility of foam formation.

Reverse Pipetting

The Fill step has as an option for an adjustable excess volume (Picture D15). As a default the excess volume is 0 µl.

If the excess volume is set to some other value than 0 µl, a plus sign appears on the top of the Fill step symbol in the program list (Picture D16).

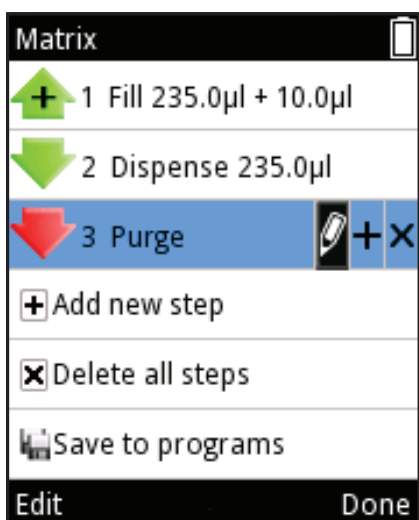

Picture D16.

Serial Dispensing

To ensure optimal performance in Serial Dispensing applications, a pipette model-specific excess volume is automatically used as a part of the Fill step when followed by a Multi or Auto step.

The excess volume can also be adjusted by the user to support different applications and requirements. To adjust the excess volume, select Fill step and Edit.

During use, the set excess volume is automatically drawn into the tip together with the fill volume.



See also the example **Serial Dispensing** in the chapter [D.5 Application Examples](#).



D.2.1.5.2 Dispense – Dispensing liquid

Change the volume using ,  or the **Volume editor** (section D.1.2).

Scroll to **Speed** and change the value using , .

Scroll to **Blowout** and change the value using , . Note that the Blowout setting may not be visible, see below for more information.

Press  (**Done**) when the changes are ready.

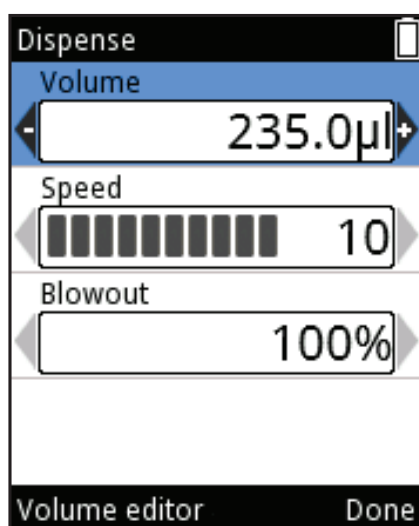

Picture D17.

Dispense Step in Forward Pipetting

In pipetting, different factors can result in some liquid remaining in the tip after dispensing. Blowout is an additional air boost ensuring efficient delivery of any remaining liquid.

In the Matrix function the Dispense step includes as an option for an adjustable Blowout volume that is shown in % (Picture D17).

The adjustable blowout is enabled when the liquid volume after the Dispense step is 0 µl., for example, after a Fill 100 µl and Dispense 100 µl pipetting sequence. The adjustable blowout is not active when the volume of Fill and Dispense steps differ from each other or if there is an excess volume programmed as a part of the Fill step (see section **The Fill Step in Reverse Pipetting and Serial Dispensing**).

The adjustable blowout is useful when optimizing the amount of air dispensed, for instance when dispensing into liquid.



D.2.1.5.3 Multi – Repeated dispensing of the same volume

Change the volume using  ,  or the **Volume editor** (section D.1.2).

Scroll to **Repetitions**, change the number using  , .

Scroll to **Speed** and change the value using  , .

Press  (**Done**) when the changes are ready.

Automatic Excess volume for the Multi step

To ensure optimal performance in serial dispensing applications, a pipette model-specific excess volume is automatically used as a part of the previous Fill step when the Multi step is added to the program.

The excess volume of the previous Fill step can also be adjusted by the user to support different applications and requirements.

See also, for example **Serial Dispensing** in the chapter [D.5 Application Examples](#).



D.2.1.5.4 Purge – Emptying the tip

Change the speed using  , .

Press  (**Done**) when the speed has been changed.



Note In certain combinations of steps a Purge step is required at the end of the sequence to empty the tip, and the text “A purge step will be added” will appear on the screen. Press  (**Ok**).



D.2.1.5.5 Mix – Mixing by pipetting a selected volume

Select the mix type: “**User controlled**” or “**Cycle based**” using  , .

Scroll to **Mix volume** and change the value using  , .

Scroll to **Speed** and change the value using  , .

If “Cycle based” is enabled, change the amount of mix cycles using  , .

Scroll to **Mix counter** and select **Counter off** / **Counter on** using  , .

Press  (**Done**) when the changes are ready.

Special considerations regarding the Mix step

If there is liquid left inside the tip before a Mix step, the liquid is dispensed before the mix cycle is initiated.

The mix cycle will end at the same volume it started with.

In order to keep the Mix step active for repeat mixing, use a Loop step. See [D.2.1.5.11 Loop step – repeat selected steps for the desired amount of cycles](#).

See also the example **Serial Dilution** in the chapter [D.5 Application Examples](#).



D.2.1.5.6 Air gap – a selected volume of air used to separate two liquids

Change the volume using  ,  or the **Volume editor** (section D.1.2).

Scroll to **Speed** and change the value using  , .

Press  (**Done**) when the changes are ready.

See also the example **Simple Dilutions** in the chapter [D.5 Application Examples](#).



D.2.1.5.7 Auto – Repeated dispensing of the same volume on defined time intervals

Change the volume using the  ,  or the **Volume editor** (section D.1.2).

Scroll to **Repetitions** and change the number using  , .

Scroll to **Speed** and change the value using  , .

Scroll to **Time** and change the value using  , .

Press  (**Done**) when the changes are ready.

Automatic Excess volume for the Auto step





To ensure optimal performance in serial dispensing applications, a pipette model-specific excess volume is automatically used as a part of the previous Fill step when the Auto step is added to the program. The excess volume of the previous Fill step can also be adjusted by the user to support different applications and requirements.

See also the example **Serial Dispensing** in the chapter [D.5 Application Examples](#).



D.2.1.5.8 Timer – Selected time before the next step can be performed

The time is defined showing two numbers for the minutes and two numbers for the seconds. Each number can be selected separately.

Use  to increase the time and  to decrease the time. Switch to the next number by using  ,  . Press  (**Done**) when the time has been changed.

See also, for example **Timed Dispensing** in the chapter [D.5 Application Examples](#).



D.2.1.5.9 Note text – a note text (e.g. a reminder) can be added

To add text, see section D.3.1.1. The maximum length of the text is five rows.

Press  (**Done**) when the text is ready.



D.2.1.5.10 Tip eject – Ejection of the tips

A tip ejection step can be selected in a Matrix program at a point when there is no more liquid in the tip.

The tip ejection step in a Matrix program can be activated either with the index finger operated trigger or with a tip ejection key.



D.2.1.5.11 Loop step – repeat selected steps for the desired amount of cycles

If the whole program or part of it needs to be repeated, it is convenient to use a Loop step. Add the Loop step after the last step of a sequence that needs to be repeated. As a default the loop start step is set to the last step before the Loop step and the amount of loop cycles is set to 2. Edit the Loop start step and amount of cycles when needed.

The steps that belong to a loop are highlighted in blue.



Note Overlapping loops (loop inside of a loop) are not permitted.

Loop cycles: the number refers to the total amount of the cycles. For example, if you want use the Mix step to add a dilution series for all 12 rows on the microplate, select the number 12 in the Loop Cycle field. See Pictures D18 and D19.

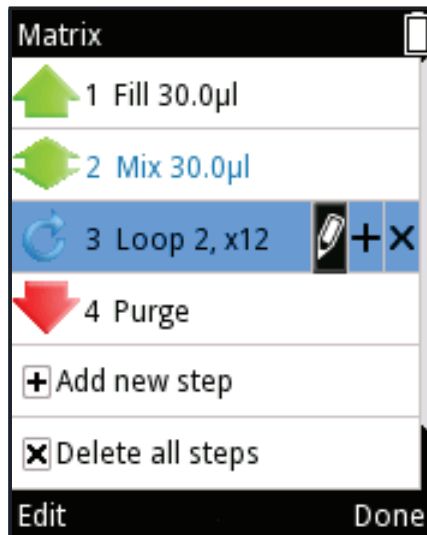

Picture D18.

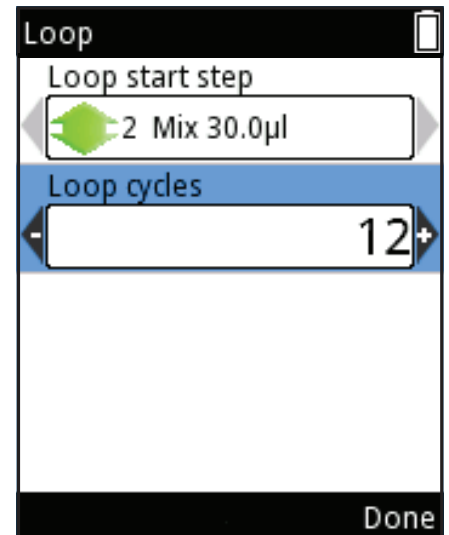



Picture D19.

See also the example Serial Dilution in the chapter [D.5 Application Examples](#).

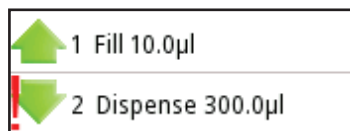

Note If the volume in a step makes the total dispense volume greater than the total fill volume before that step, then an exclamation mark will appear in front of the step to indicate that the pipetting sequence has not been correctly created. The note text *“Invalid program. Edit steps.”* will appear upon completion of the pressing stage. The pipetting sequence has to be edited before use is possible.



Note If no runnable steps have been defined for a mode, the note text *“Program does not contain any steps”* will appear. Edit the program to add steps. Press  (**Edit**) to add steps or  (**Cancel**) to return to the main menu.



Caution The user is responsible for the validity of created pipetting sequences in Matrix and Program functions.



Caution Ensure that the battery charge level is high enough, especially when using a longer pipetting sequence in the Matrix function.



D.2.2 Presets Function

The Presets function is designed for fast and easy pipetting without saving. The last used parameters will be saved automatically. The following pipetting modes are included:

- Forward
- Stepper
- Reverse
- Repetitive
- Dilute
- Pipette + Mix
- Dilute + Mix
- Manual



Picture D20.

When selecting Presets, a list of preset pipetting functions will appear on the display (Picture D20). Select the function by using  , .

By pressing  (**Use**) you enter the view where you can start using the selected dispensing function.

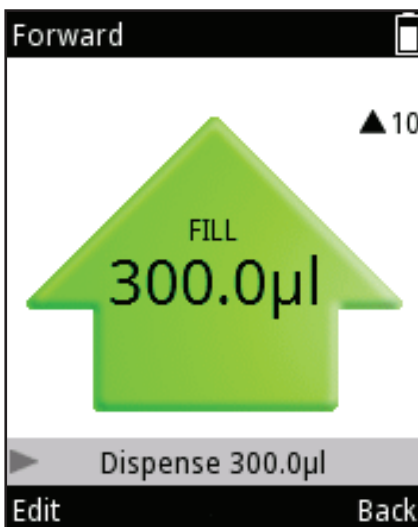

D.2.2.1 Forward

The forward mode is recommended for aqueous solutions, such as buffers, diluted acids or alkalis.



Picture D21.

To use the mode

1. Select  (**Presets**) and press  (**Select**).
2. Select **Forward** from the list and press  (**Use**).

The pipetting mode view appears on the display (Picture D21).

3. Place the tip(s) under the liquid surface and press the **trigger** to aspirate the liquid.
4. Press the **trigger** to dispense the liquid.

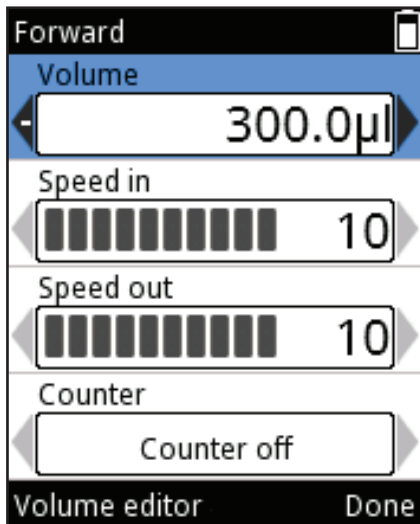

Picture D22.

To change the settings

The volume, speeds and counter options can be edited (Picture D22).

1. Press (**Edit**) in the pipetting mode view.
2. Change the volume using , or the **Volume editor** (section D.1.2).
3. Scroll to **Speed in** and change the value using , .
4. Scroll to **Speed out** and change the value using , .
5. Scroll to **Counter** and select Counter off / on using , .
6. Press (**Done**) when the changes are ready.

D.2.2.2 Stepper (Multi dispensing)

Repeated dispensing of a selected volume is possible with the stepper mode. The stepper mode is particularly suitable for microplate applications.

To use the mode

1. Select (**Presets**) and press (**Select**).
2. Select **Stepper** from the list and press (**Use**).
3. Place the tip(s) under the liquid surface and press the **trigger** to aspirate the liquid.
4. Press the **trigger** to discard the pre-step (if in use).
5. Press the **trigger** to dispense the first step and repeat until all steps have been dispensed.
6. Press the **trigger** to empty the tip (purge).

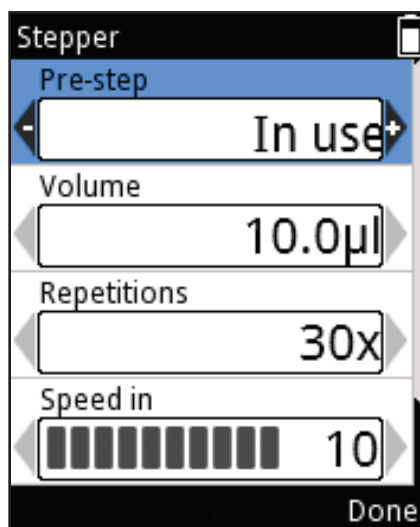

Picture D23.

To change the settings

1. Press (**Edit**) in the pipetting mode view.
2. Change the volume using , or the **Volume editor** (section D.1.2).
3. Scroll to **Repetitions** and change the amount using , .
4. Scroll to **Speed in** and change the value using , .
5. Scroll to **Speed out** and change the value using , .
6. Pre-step is an additional dispensing step that may improve the results when using certain liquids. The default setting for the pre-step is "In use", but it can be changed to "Not in use". Scroll to **Pre-step** and change the setting using , (Picture D23).
7. Press (**Done**) when the changes are ready.



D.2.2.3 Reverse

The Reverse mode (reverse pipetting) is recommended for viscous and volatile liquids. It is also recommended for solutions with low surface tension (e.g., liquids with foaming tendency). In this mode, an excess amount of liquid is aspirated in addition to set the volume. This mode is also useful when performing reagent addition where no purge is desired when dispensing.













Picture D24.

To use the mode

1. Select  (**Presets**) and press  (**Select**).
2. Select **Reverse** from the list and press  (**Use**).
3. Place the tip(s) under the liquid surface and press the **trigger** to aspirate the liquid.
4. Press the **trigger** to dispense the liquid. An excess volume will remain inside the tip.
5. The display shows "Purge" (Picture D24). Press the **trigger** to discard the excess volume.



To change the settings

1. Press  (**Edit**) in the pipetting mode view.
2. Change the volume using  ,  or the **Volume editor** (section D.1.2)
3. Scroll to **Speed in** and change the value using  , .
4. Scroll to **Speed out** and change the value using  , .
5. Scroll to **Counter** and select **Counter off / Counter on** using  , .
6. Press  (**Done**) when the changes are ready.

D.2.2.4 Repetitive

The Repetitive mode is recommended when the reverse pipetting technique is needed for a few repeated dosings of the same volume. This is particularly useful when working with volumes close to the maximum volume of the pipette.

To use the mode



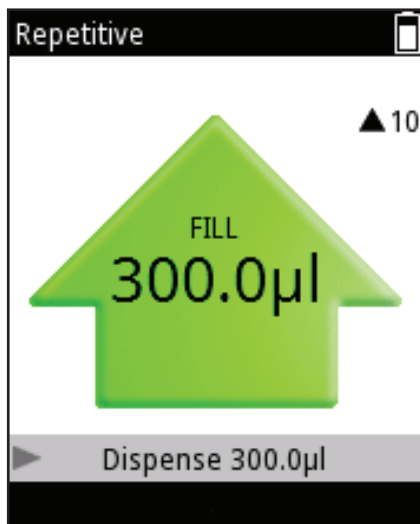







1. Select  (**Presets**) and press  (**Select**).
2. Select **Repetitive** from the list and press  (**Use**).
3. Place the tip(s) under the liquid surface and press the **trigger** to aspirate the liquid.



Picture D25.

4. Press the **trigger** and keep it pressed to dispense the liquid. Touch the tip against the edge of the reservoir to remove any possible remaining liquid on the outside surface of the tip. An excess volume will remain inside the tip.
5. Return to the original liquid reservoir and place the tips below the surface. Release the **trigger** to aspirate.
6. Repeat Steps 4 and 5 as long as needed.
7. Press the **trigger** shortly with the last dose.
8. The display shows "Purge". Press the **trigger** to discard the excess volume.

To change the settings

1. Press  (**Edit**) in the pipetting mode view.
2. Change the volume using ,  or the **Volume editor** (section D.1.2).
3. Scroll to **Speed in** and change the value using , .
4. Scroll to **Speed out** and change the value using , .
5. Scroll to **Counter** and select **Counter off / Counter on** using , .
6. Press  (**Done**) when the changes are ready.

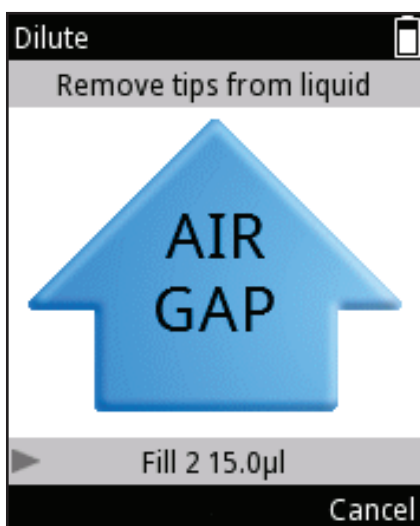

D.2.2.5 Dilute

The dilute mode enables the user to dispense two selected volumes with an air gap in-between. This is useful, for instance, when making standard curves.



Picture D26.

To use the mode

1. Select  (**Presets**) and press  (**Select**).
2. Select **Dilute** from the list and press  (**Use**).
3. Place the tip(s) under the surface of liquid 1 and press the **trigger** to aspirate the liquid (fill 1).
4. Remove the tips from the liquid. The display shows "Air gap" (Picture D26).
5. Press the **trigger** to aspirate an air gap.
6. Place the tip(s) under the surface of liquid 2 and press the **trigger** to aspirate the liquid (fill 2).
7. Press the **trigger** to dispense both volumes.

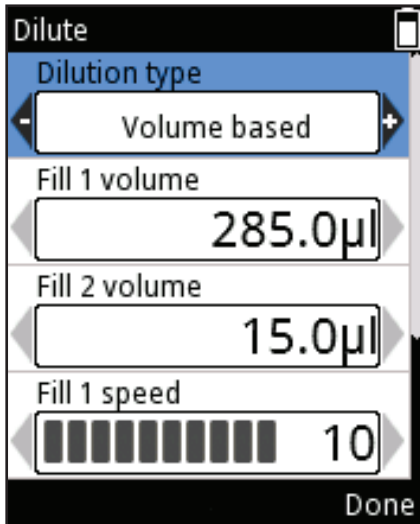

Picture D27.

To change the settings

The volumes used in the Dilute mode can be set in two different ways: ratio based and volume based.

The ratio based method uses different dilution ratios to determine the volumes to be used. Total volume and the dilution ratio define the diluent (fill 1) and sample (fill 2) volumes automatically. The diluent (fill 1) is the larger of the volumes.

In the volume based method the volumes are set directly. This volume based method uses user-defined diluent (fill 1) and sample (fill 2) volumes.

Press (**Edit**) in the pipetting mode view. Use , to select between ratio based and volume based dilution (Picture D27).

Volume based:

1. Scroll to **Fill 1 volume** and change the volume using , or the **Volume editor** (section D.1.2).
2. Scroll to **Fill 2 volume** and change the volume using , or the **Volume editor**.
3. Scroll to **Fill 1 speed** and change the value using , .
4. Scroll to **Fill 2 speed** and change the value using , .
5. Scroll to **Speed out** and change the value using , .
6. Press (**Done**) when the changes are ready.

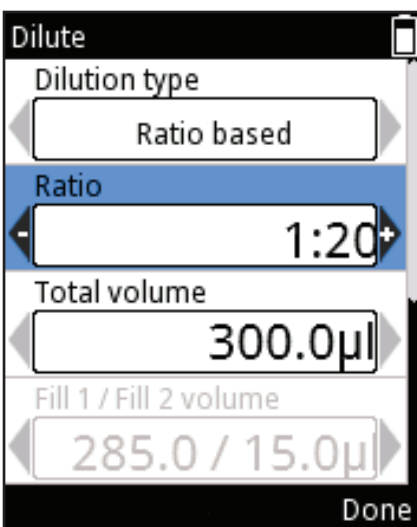

Picture D28.

Ratio based:

1. Scroll to **Ratio** and change the value using , (Picture D28).
2. Scroll to **Total volume** and change the volume using , or the **Volume editor** (section D.1.2). Fill 1 and Fill 2 volumes will be calculated automatically.
3. Scroll to **Fill 1 speed** and change the value using , .
4. Scroll to **Fill 2 speed** and change the value using , .
5. Scroll to **Speed out** and change the value using , .
6. Press (**Done**) when the changes are ready.



Note The volume and the speed of the air gap are defined automatically.

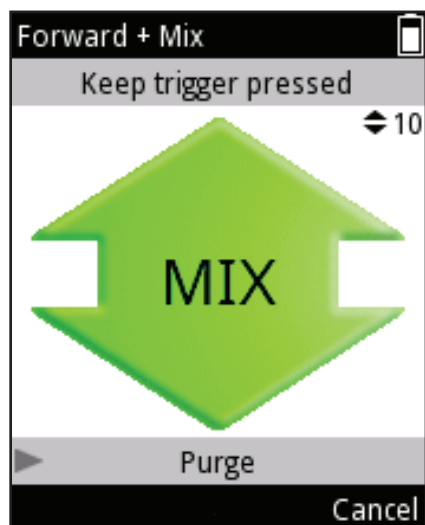

D.2.2.6 Forward + Mix

The Forward mode is recommended for aqueous solutions, such as buffers, diluted acids or alkalis. A mixing step is added after dispensing of the liquid.



Picture D29.





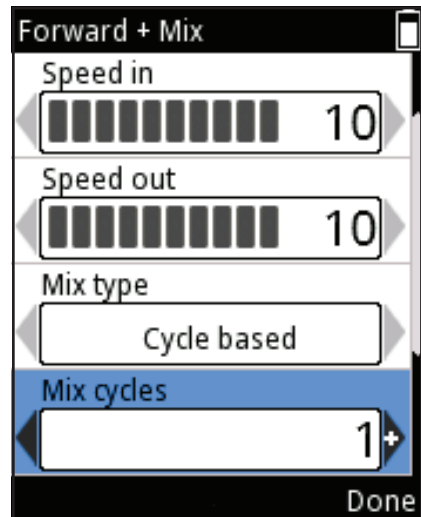











To use the mode

1. Select  (**Presets**) and press  (**Select**).
2. Select **Forward + Mix** from the list and press  (**Use**).
3. Place the tip(s) under the liquid surface and press the **trigger** to aspirate the liquid.
4. Press the **trigger** to dispense the liquid.
5. Place the tips under the surface of the liquid. Press the **trigger** to start mixing.
6. **a)** User controlled mix type: As long as the trigger is pressed down, ca. 70% of the total volume is pipetted (Picture D29).
6. **b)** Cycle based mix type: The set amount of mixing cycles is done by the pipette.
7. Next the display shows "Purge". Press the **trigger** to empty the tip (purge).



Picture D30.

To change the settings

1. Press  (**Edit**) in the pipetting mode view.
2. Change the volume using  ,  or the **Volume editor** (section D.1.2).
3. Scroll to **Speed in** and change the value using  , .
4. Scroll to **Speed out** and change the value using  , .
5. Scroll to **Mix type** and select between "User controlled" and "Cycle based" using  , .
6. If Mix type is cycle based, scroll to **Mix cycles** and change the value using  ,  (Picture D30).
7. Scroll to **Mix speed** and change the value using  , .
8. Scroll to **Counter** and select **Counter off / on** using  , .
9. Press  (**Done**) when the changes are ready.

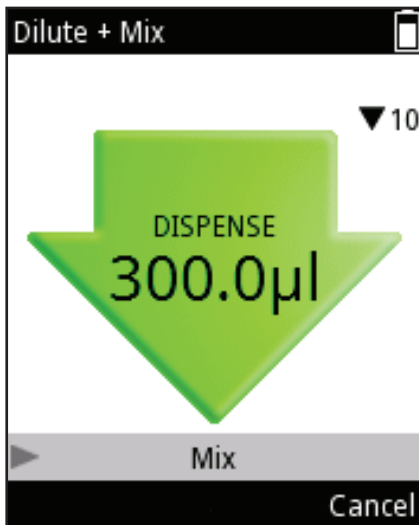

D.2.2.7 Dilute + Mix

With the Dilute + Mix mode it is possible to dispense two selected volumes with an air gap in-between, followed by mixing of the liquid.



Picture D31.

To use the mode

1. Select  (**Presets**) and press  (**Select**).
 2. Select **Dilute + Mix** from the list and press  (**Use**).
 3. Place the tips under the surface of liquid 1 and press the **trigger** to aspirate the liquid (fill 1).
 4. Press the **trigger** to aspirate an air gap.
 5. Place the tips under the surface of liquid 2 and press the **trigger** to aspirate the liquid (fill 2).
 6. Press the **trigger** to dispense the total volume (Picture D31).
 7. Place the tips under the surface of the liquid. Press the **trigger** to start mixing.
 8. **a)** User controlled mix type: As long as the **trigger** is pressed down, ca. 70% of the total volume is pipetted.
 8. **b)** Cycle based mix type: The set amount of mixing cycles is done by the pipette.
- If the mix counter is set on, a number indicating the amount of mixing cycles appears in the bottom left corner of the display (Picture D32).
9. Next the display shows "Purge". Press the **trigger** to empty the tip (purge).

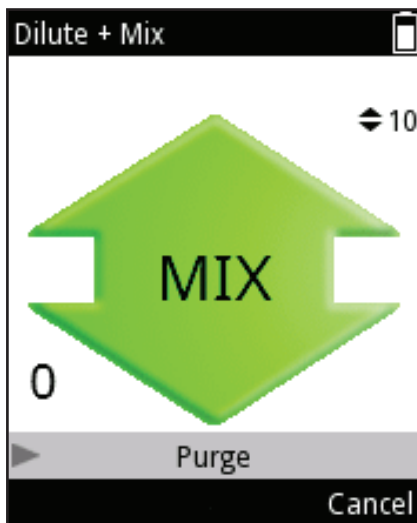



Picture D32.

To change the settings



















The volumes used in the Dilute + Mix mode can be set in two different ways: ratio based and volume based.

The ratio based method uses different dilution ratios to determine the volumes to be used. Total volume and the dilution ratio define the diluent (fill 1) and sample (fill 2) volumes automatically. The diluent (fill 1) is the larger of the volumes.

In the volume based method the volumes are set directly. This volume based method uses user-defined diluent (fill 1) and sample (fill 2) volumes.

Press  (**Edit**) in the pipetting mode view. Use  ,  to select between ratio based and volume based dilution.





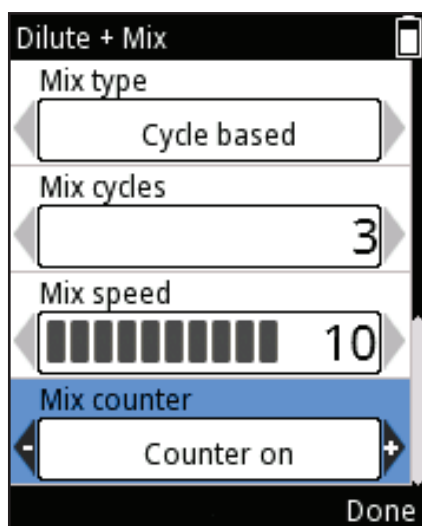













Ratio based:

1. Scroll to **Ratio** and change the value using  , .
2. Scroll to **Total volume** and change the volume using  , 
or the **Volume editor** (section D.1.2). Fill 1 and Fill 2 volumes will be calculated automatically.
3. Scroll to **Fill 1 speed** and change the value using  , .
4. Scroll to **Fill 2 speed** and change the value using  , .
5. Scroll to **Speed out** and change the value using  , .
6. Scroll to **Mix type** and select between “**User controlled**” and “**Cycle based**” using  , .
7. If Mix type is cycle based, scroll to **Mix cycles** and change the value using  , .
8. Scroll to **Mix speed** and change the value using  , .
9. Scroll to **Counter** and select **Counter off / on** using  ,  (Picture D33).
10. Press  (**Done**) when the changes are ready.



Picture D33.

Volume based:

1. Scroll to **Fill 1 volume** and change the volume using  ,  or the **Volume editor** (section D.1.2).
2. Scroll to **Fill 2 volume** and change the volume using  ,  or the **Volume editor** (section D.1.2).
3. Scroll to **Fill 1 speed** and change the value using  , .
4. Scroll to **Fill 2 speed** and change the value using  , .
5. Scroll to **Speed out** and change the value using  , .
6. Scroll to **Mix type** and select between “**User controlled**” and “**Cycle based**” using  , .
7. If Mix type is cycle based, scroll to **Mix cycles** and change the value using  , .
8. Scroll to **Mix speed** and change the value using  , .
9. Scroll to **Counter** and select **Counter off / Counter on** using  , .
10. Press  (**Done**) when the changes are ready.















D.2.2.8 Manual

The Manual mode can be used in different applications. It can be used, for instance, to evaluate the amount of remaining liquid in the reservoir or to dispense small amounts of liquid when slow speeds are needed (e.g., gel electrophoresis). The volume reset function can be utilized, for instance, in titration.



Note The Manual mode contains slower speed options than the other operation modes.

To use the mode

1. Select  (**Presets**) and press  (**Select**).
2. Select **Manual** from the list and press  (**Use**).
3. Press the **trigger** to aspirate the liquid.
4. The display indicates the volume aspirated into the tip.
5. Liquid is aspirated for as long as the **trigger** is kept pressed or until the Limit volume has been reached. The motion stops when the **trigger** is released.
6. When the **trigger** has been released before achieving the Limit volume, the movement direction can be changed by pressing  (**Out**) or  (**In**) (the text guided button depends on the current movement direction) (Picture D34).
7. Dispensing the liquid will show as a descending value on the display.
8. Optional: The volume value on the display can be reset to 0 at any point by pressing  (**Reset/Cancel**). The Reset/Cancel selection window appears (Picture D35). Select **Reset** using  ,  and press  (**Done**). The volume on the display is 0. Dispensing liquid from the tip will show as a negative value.
9. Optional: The ongoing dispensing sequence can be interrupted by pressing  (**Reset/Cancel**). The Reset/Cancel selection window appears. Select **Cancel** using  ,  and press  (**Done**). Press  (**Yes**) to cancel the dispensing sequence. "Purge" will appear on the display. Press the **trigger** to dispense.

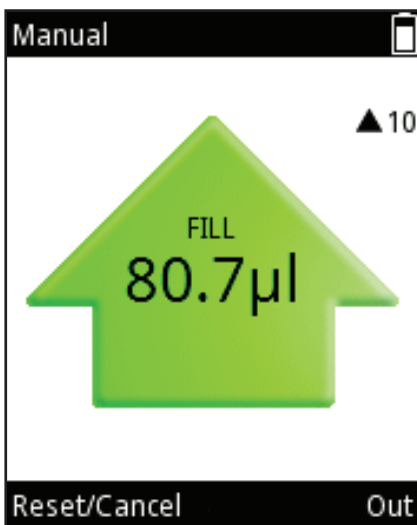

Picture D34.

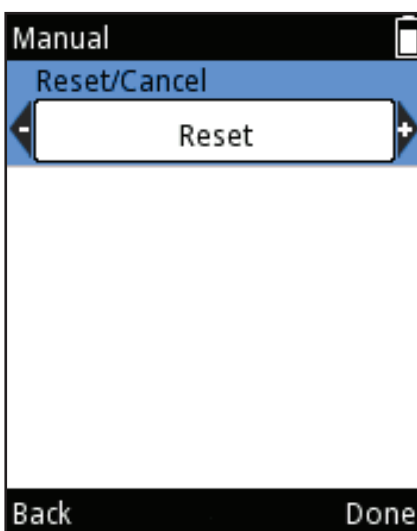

Picture D35.



Note After all the liquid has been dispensed, the **Back** button will appear again. Press (**Back**) to go back to the Presets list.

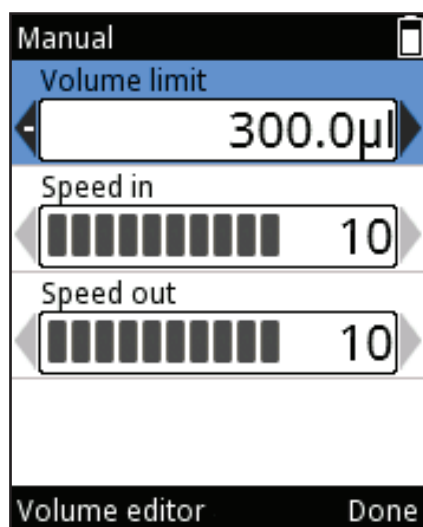

Picture D36.

To change the settings

1. Press (**Edit**) in the pipetting mode view.
2. Change the limit volume using , or the **Volume editor** (section D.1.2). The limit volume value is the maximum volume that can be aspirated. The limit volume can be set between the minimum and maximum volumes of the pipette model (Picture D36).
3. Scroll to **Speed in** and change the value using , .
4. Scroll to **Speed out** and change the value using , .
5. Press (**Done**) when the changes are ready.

D.2.3 Programs Function

Application: The Programs function is designed for creating and storing programs. Save time and ensure data integrity by storing your most used protocols.

Description: The Programs function includes both Matrix and Presets based programming styles. See the chart in section D.1. It is possible to store up to 30 individual programs with personalized names and with liquid or application specific calibrations (adjustment settings) for increased accuracy and precision. See sections E.5.2 and E.5.3 for further information.

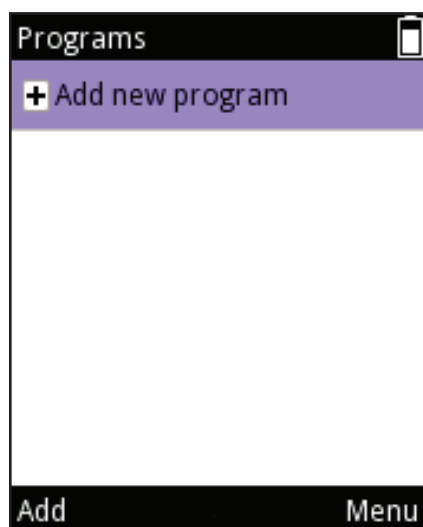

Picture D37.

Adding a new program

1. Select (**Program**) and press (**Select**).
2. Scroll to **Add new program** and press (**Add**) to add a new program (Picture D37).
3. The following programs can be selected by scrolling and pressing (**Select**):
Matrix, Forward, Stepper, Reverse, Repetitive, Dilute, Pipette + Mix, Dilute + Mix, and Manual.

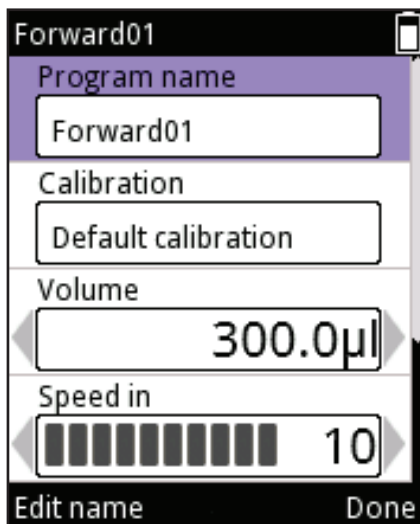

Picture D38.

4. The new program is given a default name that can be edited. Scroll to **Program name** and press (**Edit name**) (Picture D38). To add a text, see section D.3.1.1 on how to use the virtual keypad to change the name.

The maximum number of characters in a Program name is 50. Use arrow keys , to scroll through the whole name if it's not completely visible in the field.

Press (**Done**) when the changes are ready.

5. The new program is linked to the "Default calibration". Different calibrations can be selected if special adjustment settings have been created (section 5.2). Scroll to **Calibration** and press (**Calibration list**). Scroll to the intended adjustment setting and press (**Select**). The pipette returns to the program settings.

6. Each program contains a set of values that need to be defined before use.

Press (**Done**) when the changes are ready.



Note When the user changes the default adjustment setting to a user created adjustment setting, the pipette indicates this with a balance symbol together with the name of the selected calibration in the display title field during the use of the program.

Editing an existing program

1. Select (**Programs**) and press (**Select**).
2. Scroll to the stored program to be edited.
3. Use , to highlight the icon and press (**Edit**).
4. Each program contains a set of values that need to be defined before use. Press (**Done**) when the changes are ready.

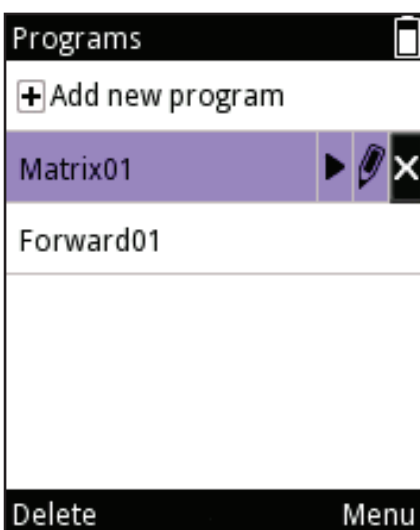

Picture D39.

Deleting a program

1. Select (**Programs**) and press (**Select**).
2. Scroll to the stored program to be deleted.
3. Use , to highlight the icon and press (**Delete**) (Picture D39).
4. Confirm deleting by pressing (**Yes**).

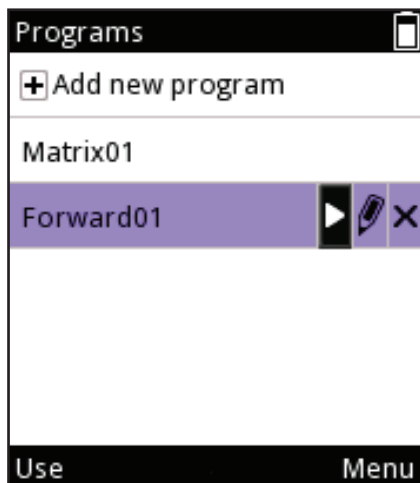







Picture D40.



D.3 Supporting Functions

Using a stored program

1. Select  (**Programs**) and press  (**Select**).
2. Scroll to the stored program to be used.
3. Use  ,  to highlight the  icon and press  (**Use**) (Picture D40).

Caution The user is responsible for the validity of the created pipetting sequence in the Matrix and Programs functions.

Caution Ensure that the charge level of the battery is high enough, especially when using a longer pipetting sequence in the Matrix function.











D.3.1 My Pipette

It is possible to personalize the E1-ClipTip pipette user interface in the My Pipette function.

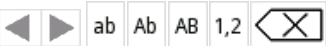
D.3.1.1 Pipette Name

It is possible to give the E1-ClipTip pipette a personal name in this mode. The name is shown in the main menu title field and on the display when the pipette is in sleep mode (Picture D41). *E1-ClipTip* is used as a default name.

To change the default name:

1. Select  (**My Pipette**) and press  (**Select**).
2. Select **Pipette Name** and press  (**Select**).
3. The display shows a **virtual keypad** that is used to edit the name (Picture D42).
4. To edit the text in the **editor field**, move the cursor in the virtual keypad and enter a character pressing  (**Select**). The character set can be changed or a character can be deleted by selecting the desired type slot on the upper row of the virtual keypad  by using the  ,  and  ,  keys and pressing  (**Select**).
5. Different key functions are defined in the table below.
6. Press  (**Done**) after entering the desired name or text.

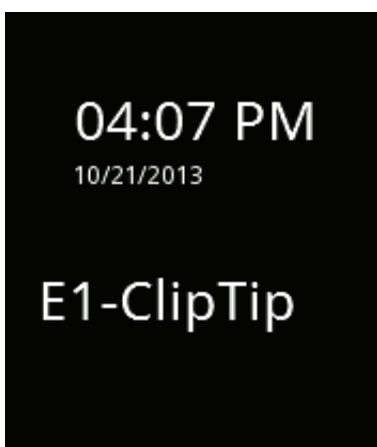

Picture D41.



Picture D42.

Virtual keypad functions:



Move the highlight within the keypad in a horizontal direction.



Move the highlight within the keypad in a vertical direction.



The Left selection key (Select) confirms the virtual keypad selection.



The Right selection key (Done) confirms the contents of the editor field and stops editing.



Move the cursor left/right in the editor field (text).



Deletes a character to the left of the cursor in the editor field.

ab

Changes the characters in the keypad to lowercase letters.

Ab

The uppercase keypad is used at the beginning and after a full stop, otherwise, the lowercase keypad is used.

AB

Changes the characters in the keypad to uppercase letters.

1,2

Changes the characters in the keypad to numbers and special characters.

D.3.1.2 Shortcuts

This mode enables the user to create icon shortcuts and place them in the main menu view to provide quick access to favorite programs and pipetting functions. Select a shortcut icon to quickly start the program or pipetting function – without scrolling in menus or folders.

There are eight icon shortcut slots available in the E1-ClipTip pipette. Shortcuts are placed in the main menu in addition to the six main function icons.

Shortcuts can be created for Presets pipetting modes or user created programs saved under the Programs function. The  icon is used for

Presets pipetting mode shortcuts and the  icon for program shortcuts.

The name of the pipetting mode or program will be displayed below the icon.

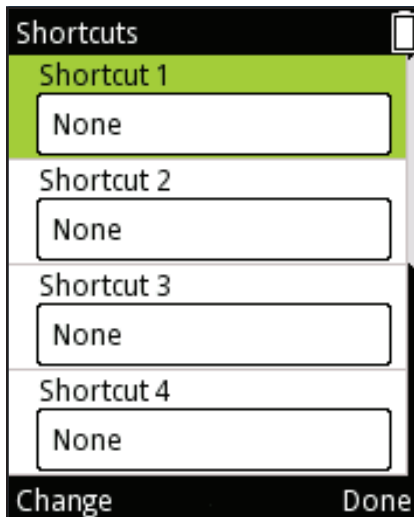



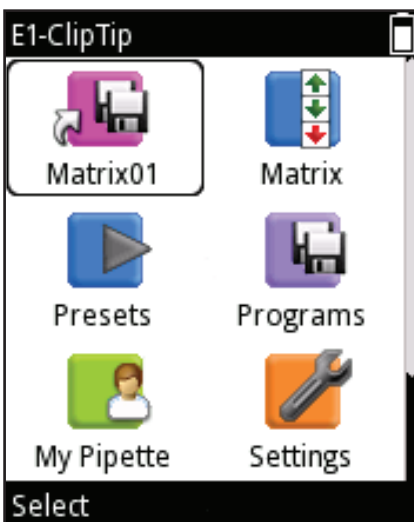









Picture D43.



Picture D44.



Creating a shortcut

1. Select  (**My Pipette**) and press  (**Select**).
2. Select **Shortcuts** and press  (**Select**).
3. A list of eight icon shortcut slots is displayed (Picture D43).
4. Use ,  to highlight the preferred slot.
5. Press  (**Change**) to change the content of each shortcut.
6. A list of Matrix and Presets functions pipetting modes and stored programs will appear.
7. Use ,  to highlight the preferred mode or program or "None", and press  (**Ok**).
8. Select the icon color using ,  and press  (**Ok**).
9. Press  (**Done**) when the changes are ready.
10. The created shortcut appears at the top of the main menu view (Picture D44).















Note When a pipetting function or program is edited through a shortcut, the changes will also be stored in the original function or program. When the original function or program is edited, the shortcut will be updated automatically. When a stored program is deleted, a program shortcut is also deleted.

D.3.1.3 Organize Icons

In this mode it is possible to organize the icons in the main menu, enabling fast access to the most used functions.





Picture D45.







1. Select  (**My Pipette**) and press  (**Select**).
2. Select Organize icons and press  (**Select**).
3. Move the cursor over to the desired icon using the ,  and ,  keys. Press  (**Move**) to select a desired icon.
4. Arrow symbols appear within the cursor frame around the icon to be moved (Picture D45). Move the icon using the ,  and ,  keys to a desired place in the menu, and press  (**Ok**). The icon has now been moved to a new location in the main menu.
5. Press  (**Ready**) after the changes have been done.

D.3.1.4 Password Protection

Editing of the user programs, default calibration, special calibrations and some other items under **Programs**, **Settings** and **My Pipette** main menu functions can be protected with a password. See a complete list of protectable items below.

Function	Protectable Items
	<ul style="list-style-type: none">• Programs created by the user
	<ul style="list-style-type: none">• Connections• Default calibration• Special calibrations created by the user• Recovery
	<ul style="list-style-type: none">• Pipette name• Shortcuts• Organizing of icons• Users• Thermo Fisher Cloud

D.3.1.4.1 Setting the password

1. Select  (**My Pipette**) and press  (**Select**).
2. Select **Password protection** and press  (**Select**).
3. Press  (**Select**) to set the password (Picture D46).
4. Set the password using the **virtual keypad** (Picture D47). Press  (**Done**) when ready.
5. An info text confirming the password appears on the display (Picture D48). Press  (**Ok**).

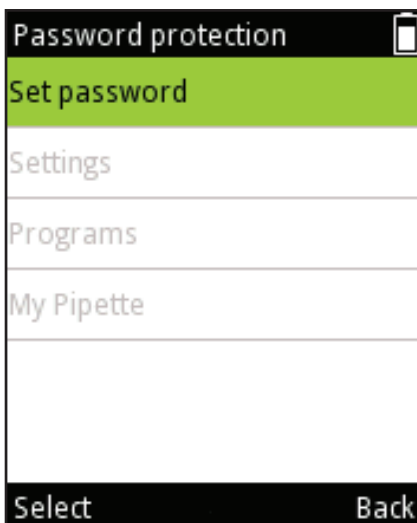

Picture D46.













Picture D47.



Picture D48.

D.3.1.4.2 Protecting/Unprotecting items

1. Open **Password protection** from the  (**My Pipette**) main menu function. Note that you have to enter a valid password if the protection is already set.
2. Select the main menu function name where the protectable item is located from the list (Picture D49) and press  (**Select**).
3. Select the item to be protected from the list and press  (**Protect**) (Picture D50). A  icon appears on the item row to indicate that the item is protected and cannot be edited before the password is entered or protection is removed. Note that you can now also unprotect a protected item by pressing  (**Unprotect**).
4. Press  (**Back**) when all items to be locked are protected. The  icon also appears on the main menu function row that contains a locked item. The  icon is black if all items under the main menu function are protected and  gray if only certain items are locked under the main menu function (Picture D51).
5. Press  (**Back**) to exit the Password protection mode.

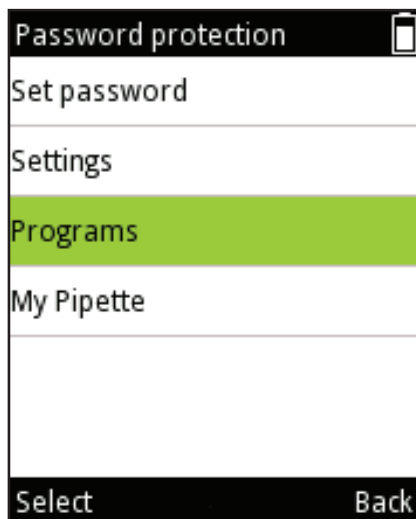

Picture D49.





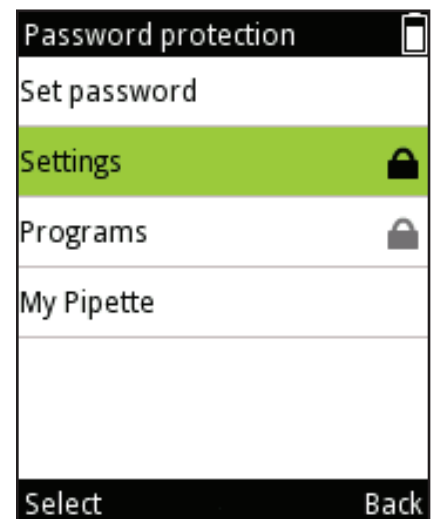



Picture D50.



Picture D51.

D.3.1.4.3 Removing the Password protection

1. Open **Password protection** from the  (**My Pipette**) main menu function. Note that you have to enter a valid password if the protection is already set.
2. Select **Set password** and press  (**Select**) (Picture D52).
3. Select the  backspace symbol from the **Set password** text editor and press  (**Select**) multiple times until the text input field is empty (Picture D53)
4. Press  (**Reset**) to accept an empty password.
5. An info text confirming the password appears on the display (Picture D54). Press  (**Ok**).
6. Press  (**Back**) to exit the Password protection mode.

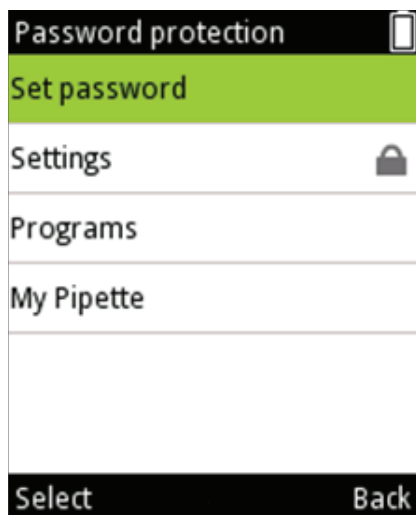

Picture D52.

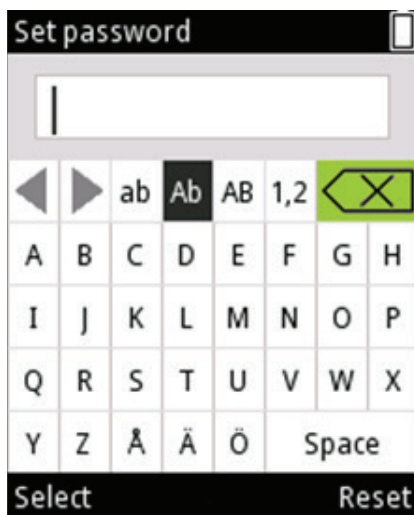

Picture D53.

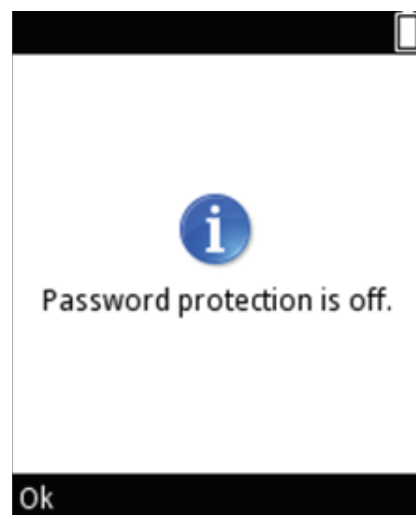

Picture D54.

D.3.1.5 User Profiles

E1-ClipTip pipette has a function to create multiple user profiles which allow personalizing of settings and creation of own programs per user profile. There is one Default User and four additional user profiles (User 1- User 4).







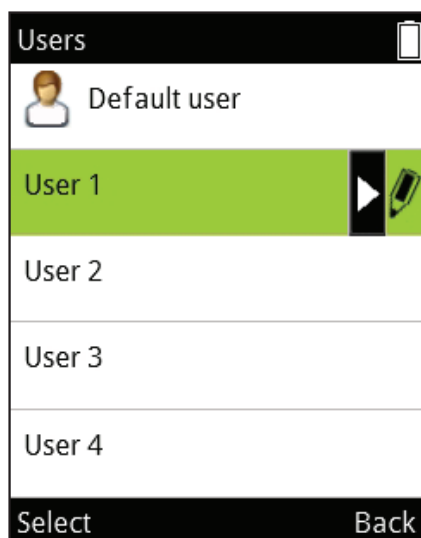



The Default user profile name can be locked but the names of users 1-4 can be edited. Each user can personalize their settings, create their own programs and customize their main menu as preferred. Each user has the maximum number of programs (30) and shortcuts that can be created.

The Default User is the only user profile that can reset the Default Calibration of the pipette. Changing the Default calibration parameters will affect all pipetting modes under the Matrix and Presets functions in all user profiles. For more information on how to change Default calibration, see section E.5.1.

Both Default user and additional users can add a special adjustment setting for calibrations that can be used in stored programs. For more information on how to define and use special adjustment settings, see sections E.5.2 to E.5.4.



Picture D55.

1. Select  (**My Pipette**) and press  (**Select**).
2. Select **Users** and press  (**Select**).
3. A list of five User slots is displayed (Picture D55).
4. Use ,  to highlight the preferred user slot.
5. The name of users 1-4 can be edited :
Use ,  to highlight the  icon and press (**Edit**).
Set the user name using the virtual keypad.
Press  (**Done**) when ready.
6. Press  (**Select**) to take the preferred user slot in use.

D.3.1.6 Thermo Fisher Cloud

Pipetting functions for the E1-ClipTip pipette can also be programmed via My Pipette™ Creator App in the Thermo Fisher Cloud.

The connection between the My Pipette Creator App and the pipette can be established either wirelessly (Bluetooth) or by using a USB cable. For more information on how to set connection type, see section D.3.2.2

Create your Thermo Fisher Cloud account and sign in at <http://www.thermofisher.com/uk/en/home/cloud.html>

More instructions on how to use My Pipette Creator App and how to connect your E1-ClipTip pipette to your Cloud account can be found there.

The steps to connect your E1-ClipTip pipette to the Thermo Fisher Cloud are:

1. Create your Cloud account and sign in
2. Open My Pipette Creator App
3. Download and install My Pipette Connect Utility software that allows file transfer between the pipette and the App. (required only once per PC)
4. Connect your E1-ClipTip to your PC by Bluetooth or USB cable
5. Add a new E1-ClipTip pipette in the My Pipette Creator App by using the pairing code given by the E1-ClipTip pipette

To receive the code:

1. Select  (**My Pipette**) and press  (**Select**).
2. Select **Thermo Fisher Cloud** and press  (**Select**) (Picture D56).
3. Press  (**Ok**) to receive a pairing code.

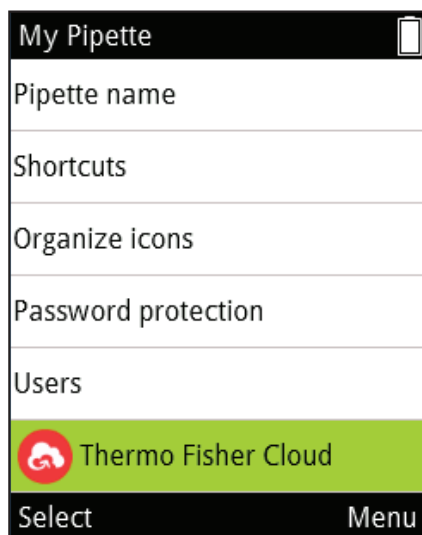

Picture D56.

D.3.2 Settings

The Settings function contains the tools to define basic functions, tracking settings, and audio response of the pipette (Picture D57).

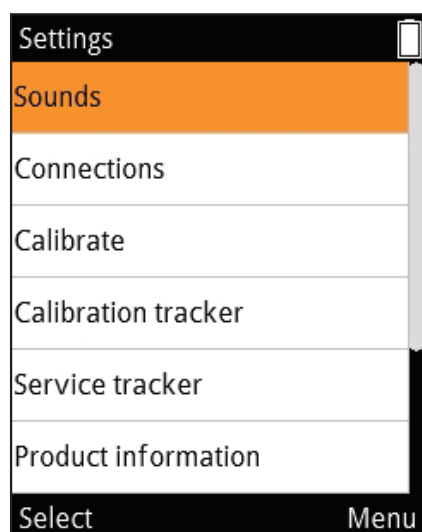









Picture D57.

D.3.2.1 Sounds









The Sounds option allows the user to control the function indicator sounds and keypad key response sounds.

To modify the buzzer settings:

1. Select  (**Settings**) and press  (**Select**).
2. Select **Sounds** and press  (**Select**).
3. Scroll in the menu using  ,  .
4. Set the pipetting and keypad sounds on/off using  ,  .
5. The sound level can be set at 5 different volumes.
6. Press  (**Done**) after editing the settings.

D.3.2.2 Connections

The Connection option allows to set the USB and / or Bluetooth connection On or Off.

1. Select  (**Settings**) and press  (**Select**).
2. Select **Connections** and press  (**Select**).
3. Scroll in the menu using , .
4. Set the USB and Bluetooth on/off using , .
5. Press  (**Done**) after editing the settings.

D.3.2.3 Calibrate

It is possible to reset the adjustment parameters for Default calibration or add and define new calibration settings (special adjustment settings) in the Calibrate function.

When changing the Default calibration settings, all functions under Matrix and Presets are affected in all user profiles.









Default calibration can only be edited under Default user profile (see D.3.1.5).







Add new calibration allows the user to define a special adjustment setting that can be used in stored programs. It is possible to define up to five different adjustment settings. For more information on how to define and use special adjustment settings, see sections E.5.2 to E.5.4.

D.3.2.4 Calibration Tracker

The Calibration tracker function allows the user to set up a reminder that appears as an icon in the upper field of the pipette display. The Calibration tracker informs the user when the set time limit or a pipetting cycle limit is reached, and reminds the user to recheck the pipette performance.

To set the Calibration tracker:

1. Select  (**Settings**) and press  (**Select**).
2. Select **Calibration tracker** and press  (**Select**).
3. Scroll in the menu using , .
4. Set the remainder on/off using , .
5. Select the cycle based (pipetting cycles) or time based tracker type using , .

6. Scroll to **Reminder interval**. Pressing  ,  activates the Reminder interval window. Set the limits using  ,  and  ,  for the selected tracker type. The cycle based tracker can be set between 1 and 999999 pipetting cycles. The time based tracker can be set between 1 and 999 days.

















The Calibration tracker window also shows the cumulative values from the last calibration, cycles when the cycle based option has been selected and days when the time based option has been selected, and the date of the last calibration. These values are reset when one of the created calibrations in a user profile is changed.(section E.5.1).



Caution The Calibration counter notifies the user only about the limits reached according to the Default calibration. The user is responsible for checking the validity of personalized adjustment settings used in stored programs.

D.3.2.5 Service Tracker

This mode allows the user to set up the service tracker reminder parameters. The tracker will show a reminder icon in the upper field of the display when the set time limit has been reached. Also the counter from the last service can be viewed in this mode.

1. Select  (**Settings**) and press  (**Select**).
2. Select **Service tracker** and press  (**Select**).
3. Move in the menu using  ,  .
4. Switch the tracker on/off using  ,  .
5. Scroll to **Reminder interval**. Using  ,  the Tracker interval set window will open. Set the interval using  ,  and  ,  .
The interval can be set between 1 to 999 days.
6. Press  (**Done**) after setting the interval.
7. The tracker counter can be reset by pressing  (**Reset tracker**).
8. Exit the Service tracker mode by pressing  (**Done**).
9. Press  (**Yes**) to verify the changes.



Note The tracker counter is not reset automatically. The user only needs to perform the reset manually (see Step 7).

D.3.2.6 Product Information

1. Select  (**Settings**) and press  (**Select**).
2. Select **Product information** and press  (**Select**).
3. The product information will appear on the screen. This is important in product specific customer enquiries and product service issues. Provide this information when corresponding with the manufacturer or dedicated service houses.





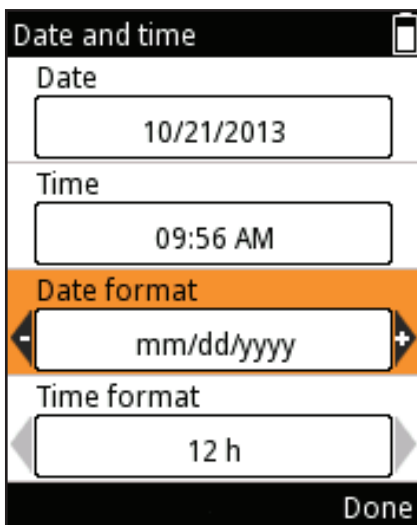





D.3.2.7 Date and Time

The Date and time option allows the user to change the corresponding settings. The date and time affect calibration and service tracker functions.



Picture D58.





To edit the date and time settings:

1. Select  (**Settings**) and press  (**Select**).
 2. Select **Date and time** and press  (**Select**).
 3. Scroll in the menu using  , .
 4. Set the Date and Time by selecting the corresponding slot and press  (**Set**).
 5. Press  (**Done**) after entering the value.
 6. Date format and Time format can be changed by using  , .
- (Picture D58).
7. Press  (**Done**) when all the values have been defined.

D.3.2.8 Recovery



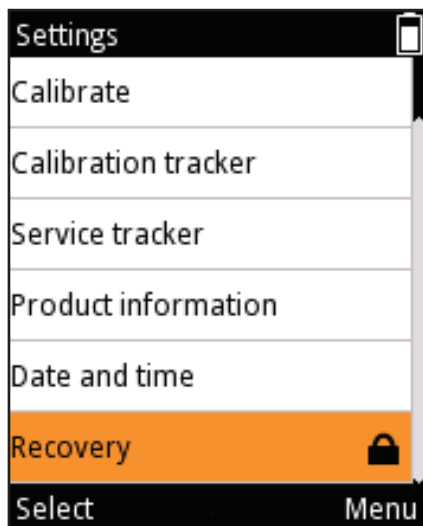

Recovery is used to return the factory settings to the pipette.

To return the factory settings:

1. Select  (**Settings**) and press  (**Select**).
2. Select **Recovery** and press  (**Select**).
3. The pipette warns against clearing all user data. Press  (**Proceed**) to continue.
4. Press  (**Ok**) to confirm the recovery process.



Picture D59.

5. The pipette will restart.
6. Scroll in the menu using  ,  . Set the Date, Time, and the desired Date and Time formats by selecting the corresponding slot, and press  (**Set**).
7. Press  (**Done**) after entering the value.
8. Press  (**Done**) when all the values have been defined.



The Recovery function can be protected with a password (Picture D59). See section D.3.1.3.



Caution All user edited programs, calibration settings and personalized pipette settings will be cleared. The user is responsible for redefining personal changes after the recovery procedure.

D.3.2.9 Connect Piston

The settings menu also contains the piston detachment/connection mode for single channel pipettes.



1. Select  (**Settings**) and press  (**Select**).
2. Select **Connect piston** and press  (**Select**).

This mode allows the user to move the piston to a position where it is easy to remove using the piston tool B. The mode is also used to connect the piston to the motor after service operations. See section G.3 on how to remove and connect the piston.

D.4 Power Function

The Power function allows the user to manually shut down the pipette and save the battery when the pipette is not used for a longer period of time.

To shut down the pipette:

1. Select  (**Power**) and press  (**Select**).
2. Press  (**Yes**) to confirm the shut down.



Note The pipette will automatically go to power off mode after 1 h if not used.

D.5 Application Examples

Examples of creating different pipetting sequences are given below. Both “**Matrix**” and “**Presets**” can be used for the same tasks. The preferred method is always described first.



Matrix



Presets









Note These examples assume that the **Matrix** program is empty. If it is not empty, then use the “**Delete all steps**” option in the **Matrix** edit view.





Sample Transfers

Example: Fill and dispense 100 µl.

Using Presets:

1.	 Presets	(Select). Select the Presets icon from the main menu.
2.		Use the Up/Down keys to highlight “ Forward ”.
3.		(Use). Select the function to use.
4.		(Edit). Edit the function.
5.		Use the Left/Right keys or the Volume editor to adjust the volume to 100 µl .
6.		(Done). The volume is accepted and the function is ready to run.









Using Matrix:

1.	 Matrix	(Select). Select the Matrix icon from the main menu.
2.		(Select).  Fill step is added.
3.		Use the Left/Right keys or the Volume editor to adjust the volume to 100 µl .
4.		(Done). The volume is accepted.
5.		(Done). The program is ready.
6.		(Ok).  Purge step is added.
7.		(Done). The function is ready to run.

Serial Dispensing

Example: Fill a 96-well plate with 100 µl per well using an 8-channel 1250 µl pipette.















Using Presets:









1.	 Presets	(Select). Select the Presets icon from the main menu.
2.		Use the Up/Down keys to highlight " Stepper ".
3.		(Use). Select the function to use.
4.		(Edit). Edit the function.
5.		Use the Left/Right keys or the Volume editor to adjust the volume to 100 µl .
6.		Use the Up/Down keys to highlight " Repetitions ".
7.		Use the Left/Right keys to adjust the repetitions to 12 .
8.		(Done). The function is ready to run.



Note It is recommended to set the **Pre-step** to "**In use**" in the **Stepper** function.



















Using Matrix:













1.	 Matrix	(Select). Select the Matrix icon from the main menu.
2.		(Select).  Fill step is added.
3.		Use the Left/Right keys or the Volume editor to adjust the volume to 1250 µl .
4.		(Done). The volume is accepted.
5.		(Add). Add a new step.
6.		Use the Down key to highlight " Dispense ".
7.		(Select).  Dispense step is added. This step is for discarding the first 50 µl.
8.		Use the Left/Right keys or the Volume editor to adjust the volume of 50 µl .
9.		(Done). The volume is accepted.
10.		(Add). Add a new step.
11.		Use the Down key to highlight " Multi ".
12.		(Select).  Multi step is added.

13.		Use the Left/Right keys or the Volume editor to adjust the volume to 100 µl .
14.		Use the Up/Down keys to highlight " Repetitions ".
15.		Use the Left/Right keys to adjust the repetitions to 12 .
16.		(Done) . The volume is accepted.
17.		(Done) . The editing is ready.
18.		(Ok) .  Purge step is added.
19.		(Done) . The function is ready to run.

Serial dispensing example: Fill several 96-well plates in a row without a Purge step between the plates. The maximum Fill volume of the 300 µl pipette model is used in the example.

Using Matrix:

1.	 Matrix	(Select) . Select the Matrix icon from the main menu.
2.		(Select) .  Fill step is added.
3.		Use the Left/Right keys or the Volume editor to adjust the volume to 0 µl .
4.		Use the Up/Down keys to highlight " Excess volume ".
5.		Use the Left/Right keys or the Volume editor to adjust the Excess volume to, for example, 30 µl.
6.		(Done) . The volumes are accepted.
7.		(Add) . Add a new step.
8.		(Select) .  Fill step is added.
9.		(Done) . Keep max Fill volume (or adjust) and keep Excess volume as 0 µl.
10.		(Add) . Add a new step.
11.		Use the Down key to highlight " Multi ".
12.		(Select) .  Multi step is added.
13.		Use the Left/Right keys or the Volume editor to adjust the volume to 50 µl .
14.		Use the Up/Down keys to highlight " Repetitions ".
15.		Use the Left/Right keys to adjust the repetitions to 6 .

16.		(Done). The parameters are accepted.
17.		(Add). Add a new step.
18.		Use the Up key to highlight "Loop" .
19.		(Select).  Loop step is added.
20.		Use the Left/Right keys to choose the second Fill step (300 µl) to be the start step of the loop.
21.		Use the Down key to highlight "Loop cycles" .
22.		Use the Left/Right keys to adjust the loop cycle value to, for instance, 4 .
23.		(Done). The Loop start step (2 Fill 300 µl) and cycle values are accepted.
24.		(Done). The editing is ready.
25.		(Ok).  Purge step is added.
26.		(Done). The function is ready to run.

Simple Dilutions

Example: Prepare a 1:10 dilution with a 10 µl sample volume.













Note The first fill volume is for the diluent followed by the air gap volume and finally by the sample volume.























Note Tenfold serial dilutions can be done by repeating this example multiple times.

Using Presets:

1.	 Presets	(Select). Select the Presets icon from the main menu.
2.		Use the Up/Down keys to highlight "Dilute" .
3.		(Use). Select the function to use.
4.		(Edit). Press Edit .
5.		Use the Left/Right keys to select "Volume based" dilution.
6.		Use the Up/Down keys to highlight "Fill 1 volume" .
7.		Use the Left/Right keys or the Volume editor to adjust the volume to 90 µl .
8.		Use the Up/Down keys to highlight "Fill 2 volume" .
9.		Use the Left/Right keys or the Volume editor to adjust the volume to 10 µl .
10.		(Done). The function is ready to run.

Using Matrix:

1.	 Matrix	(Select) . Select the Matrix icon from the main menu.
2.		(Select) .  Fill step is added.
3.		Use the Left/Right keys or the Volume editor to adjust the volume to 90 µl .
4.		(Done) . The volume is accepted.
5.		(Add) . Add a new step.
6.		Use the Down key to highlight " Air gap ".
7.		(Select) .  Air gap step is added.
8.		Use the Left/Right keys or the Volume editor to adjust the volume of 20 µl .
9.		(Done) . The volume is accepted.
10.		(Add) . Add a new step.
11.		(Select) .  Fill step is added.
12.		Use the Left/Right keys or the Volume editor to adjust the volume to 10 µl .
13.		(Done) . The volume is accepted.
14.		(Done) . The editing is ready.
15.		(Ok) .  Purge step is added.
16.		(Done) . The function is ready to run.





















Timed Dispensing

Example: Using the timer in initiation of enzymatic reactions at 30 sec intervals.



Note The timer function is only available in the **Matrix mode**.

Using Matrix:

1.		(Select) . Select the Matrix icon from the main menu.
2.		(Select) .  Fill step is added.
3.		Use the Left/Right keys or the Volume editor to adjust the volume to 150 µl .
4.		(Done) . The volume is accepted.
5.		(Add) . Add a new step.
6.		Use the Down key to highlight " Dispense ".
7.		(Select) .  Dispense step is added.
8.		Use the Left/Right keys or the Volume editor to adjust the volume of 30 µl .
9.		(Done) . The volume is accepted.
10.		(Add) . Add a new step.
11.		Use the Down key to highlight " Timer ".
12.		(Select) .  Timer step is added.
13.		Use the Up/Down and the Left/Right keys to set the timer to 30 s .
14.		(Done) . The timer setting is accepted.
15.	Repeat Steps 5 to 14 three times in order to create three more dispense and timer steps. The last dispensing will be done with the Purge step .	
16.		(Done) . The editing is ready.
17.		(Ok) .  Purge step is added.
18.		(Done) . The function is ready to run.

Serial Dilution

Example: 1:10 (30 µl + 270 µl) serial dilution on a 96-well microplate with an 8- or 12-channel 10-300 µl pipette.

270 µl of dilution buffer should be filled on each well of the plate before the dilution series is done (see example **Sample Transfers** or **Serial Dispensing** for filling the plate). The protocol consists of a repeating cycle of Aspirate 30 µl and Mix. The example below is with **Cycle based** mixing option, where mixing is automated. When selecting the **User controlled** mixing option, the duration of each mix step is controlled by the operator.

Similar protocol can be used for different dilution ratios and volumes. Pipette model and volumes used should be selected accordingly.



Note The mixing parameters, mixing volume and number of cycles, should be optimized for each application. The default parameters can be used as a basis for optimization.

Using Matrix:

1.	 Matrix	(Select) . Select the Matrix icon from the main menu.
2.		(Select) . Fill step is added.
3.		Use the Left/Right keys or the Volume editor to adjust the volume to 30 µl .
4.		(Done) . The volume is accepted.
5.		(Add) . Add a new step.
6.		Use the Down key to highlight " Mix ".
7.		(Select) . Mix step is added.
8.		(Done) . The default parameters for mixing are accepted. The parameters can be edited if needed.
9.		(Add) . Add a new step.
10.		Use the UP key to highlight " Loop ".
11.		(Select) . Loop step is added.
12.		Use the Down key to highlight " Loop cycles ".
13.		Use the Left/Right keys to adjust the loop cycle value to, for instance, 12 .
14.		(Done) . The Loop start step (Mix step) and cycle values are accepted.
15.		(Done) . The editing is ready.
16.		(Ok) . Purge step is added.
17.		(Done) . The function is ready to run.

Dispensing instructions:

1. Aspirate 30 μ l of the undiluted sample into the tips.
2. Dispense + mix into the first row of the plate. Keep the tips in the wells after dispensing because mix steps and next aspiration step start immediately after the dispensing. After mix steps, pipette automatically aspirates the next 30 μ l into the tips.
3. Move into the next row, dispense + mix into the second row of the plate.
4. Repeat step 3 until the planned dilutions have been made.
5. After the last dilution row, press the trigger  **(Purge)** to empty liquid from the tips.

E. CALIBRATION AND ADJUSTMENT

E.1 Terminology

Calibration: Determination of the difference between the actual volume given by the device and the target volume. Also enables statistical evaluation of the deviation between individual doses.

Adjustment: Altering the pipette settings to change the actual volume to correspond to the target volume.

Default calibration: Adjustment setting for Matrix and Presets functions. The pipette uses this parameter.

Special adjustment: A user-created parameter setting that can be stored in the pipette to be used in the Programs function to improve the device performance.

Manufacturer specifications: Acceptance criteria for pipettes used by the manufacturer under strictly defined conditions. Used for quality control purposes.

ISO 8655 specifications: Acceptance criteria for pipettes recommended for pipette service or end users under strictly defined conditions. Allows more tolerance for different influencing factors.

Inaccuracy = accuracy: The error of the measured mean volume to the target volume. Can be shown as an absolute value (e.g., $A = 1.0 \mu\text{l}$) or as a relative value (e.g., $\text{ACC}\% = 0.15\%$). Inaccuracy is a systematic error.

Imprecision = precision: Statistical evaluation value of the calibration measurement series. Can be shown as an absolute standard deviation value (e.g., $s = 1.0 \mu\text{l}$) or as a relative coefficient of variation value (e.g., $\text{CV}\% = 0.1\%$). Imprecision is a random error.

Nominal volume = maximum volume indicated by the device volume range.

E.2 Factory Calibration

All Thermo Scientific pipettes are factory calibrated and adjusted to give the volumes as specified with distilled or deionized water. The performance values are defined at the nominal (maximum) volume and at 10% of the nominal volume using series of 5 doses at both points. With multichannel pipettes all channels are calibrated. Calibration is performed in a monitored environment.

The pipette should be recalibrated for use with any tip type not named on the Calibration Certificate.



Note Calibration results are place and environmental condition specific. Factory calibration assures that the devices were functional on leaving the factory. The user is responsible for checking that the calibration applies to in the intended use.

E.3 Responsibilities of the User

To assure the proper functionality of the device the user is responsible to:

- Follow the instructions of this Instructions for Use booklet.
- Assure that the device and used accessories are suitable for the intended application and are functioning properly in the intended conditions.
- Define a regular service interval for the device (calibration check and maintenance) depending on the conditions of use. The starting recommendation is every 3 months, but this can be changed according to the follow-up results. Devices should be serviced at least once a year.
- Define suitable acceptance criteria for calibration. As many premises do not necessarily meet the strict environmental and device requirements stated in the ISO 8655 standard, the user should establish acceptance criteria that meet the demands of the tasks that the devices are used for.

E.4 Performing the Calibration

The following calibration procedure is recommended to be performed under strict conditions defined below. It is recognized that many premises do not have the possibility to meet these requirements.



Note The calibration procedure is also the same under nonconforming conditions, however, the manufacturer specifications or the ISO 8655 standard specifications do not apply in these cases.

E.4.1 Device Requirements and Test Conditions

- An analytical balance should be used. The scale graduation value of the balance should be chosen according to the selected test volume of the pipette:

Minimum requirements for balances according to ISO 8655.

Tested volume area	Resolution	Repeatability and linearity	Standard uncertainty of measurement
V	mg	mg	mg
$1 \mu\text{l} \leq V \leq 10 \mu\text{l}$	0.001	0.002	0.002
$10 \mu\text{l} < V \leq 100 \mu\text{l}$	0.01	0.02	0.02
$100 \mu\text{l} < V \leq 1000 \mu\text{l}$	0.1	0.2	0.2
$1 \text{ ml} < V \leq 10 \text{ ml}$	0.1	0.2	0.2

If the uncertainty of the measurement of the balance is known, this may be used instead of the repeatability and linearity.

- Test liquid: Distilled or deionized water conforming to the ISO 3696 grade 3 requirements.
- Tests should be done in a draft-free room at a constant ($\pm 0.5^{\circ}\text{C}$) temperature of water, pipette and air between 15°C to 30°C .
- The relative humidity should be above 50%. Especially with volumes under $50\ \mu\text{l}$ the air humidity should be as high as possible to reduce the effect of evaporation loss. Special accessories, such as an evaporation trap, are recommended.



Note It is recommended to use an environmental monitoring device to assure the reliability of condition values.

E.4.2 Procedure

Note the temperature (water temperature recommended) and air pressure values before testing.

Select the Z-correction coefficient value from Appendix 1.

1. Take a new tip from the tip rack box using the pipette. Do not touch the tips by hand.
2. Pre-wet the tip 3–5 times.
3. Dispense 10 doses at 10% of the nominal volume.
4. Dispense 10 doses at the nominal volume.
5. Calculate the inaccuracy (A and ACC%) and imprecision (s and CV%) of both series (see section D.4.3).
6. Compare the results to the limits in Appendix 2 or 3.

If the calculated results are within the selected limits, the adjustment of the pipette is correct.

With multichannel pipettes calibration can be performed either to all channels (standard demand) or for the edge channels of the device.

A pipette should always be adjusted for delivery (Ex) of the selected volume. Measuring volumes taken from the balance are not allowed. Calibration should be performed using the forward pipetting method.

For maximum permissible errors, see [Appendix 2. Manufacturer Factory Specification Limits](#) and [Appendix 3. ISO8655 Calibration Specification Limits](#).



Note According to the ISO8655 the acceptance specifications mentioned in this document apply only in the Forward mode. Typical performance values for the Stepper mode can be inquired from the manufacturer.

E.4.3 Calculation Formulas

E.4.3.1 Volume Calculation

$$V = (w + e) \times Z$$

V = volume (μ l)

w = mass (mg)

Z = conversion factor (μ l/mg)

e = evaporation loss (mg)

Evaporation loss can be significant with low volumes. To determine mass loss, dispense water into the weighing vessel, note the reading and start a stopwatch. See how much the reading decreases during 30 seconds (e.g., 6 mg = 0.2 mg/s).

Compare this to the pipetting time from taring to reading. Typically the pipetting time might be 10 seconds and the mass loss is 2 mg (10 s x 0.2 mg/s) in this example. If an evaporation trap or lid on the vessel is used, the correction of evaporation is usually unnecessary.

The factor Z is for converting the weight of the water to volume at the test temperature and pressure.

A typical value is 1.0032 μ l/mg at 22°C and 95 kPa. See the conversion table in Appendix 1.

The value of the Z conversion factor depends on environmental conditions (Appendix 1). Select the factor from the table according to the air pressure and water temperature (recommended). The volume is more dependent on the water temperature than the air temperature.

E.4.3.2 Inaccuracy

$$A = \bar{V} - V_s$$

A = inaccuracy

\bar{V} = average volume

V_s = target volume (display value)

$$ACC\% = 100\% \times \frac{A}{V_s}$$

E.4.3.3 Imprecision

$$s = \sqrt{\frac{\sum_{i=1}^n (V_i - \bar{V})^2}{n-1}}$$

s = standard deviation (μ l)

\bar{V} = average volume

n = number of measurements

V_i = individual measurement result ($i = 1 \dots n$)

$$CV = 100\% \times \frac{s}{\bar{V}}$$

E.5 Adjustment

In the E1-ClipTip pipette there are two different ways to affect the adjustment settings. The Default user can change the settings for Default calibration, which affects all modes under the Presets menu for all User profiles. Additionally, Default User or all the other User profiles may create his/her own special adjustments and store them in the pipette to be used in the Programs mode for created dispensing programs.

Perform the calibration using the protocols of the desired application (section D.4.) before starting the adjustment procedures. Adjustment can be made for example, for liquids of different temperature or viscosity or for different pipetting methods, such as reverse or multi dispensing. In the E1-ClipTip calibration the max. volume always corresponds to the nominal volume of the pipette while the min. volume always corresponds to 10% of the nominal volume.



Note According to the ISO8655, the acceptance specifications mentioned in this document apply only in the Forward mode. Typical performance values for the stepper mode can be inquired from the manufacturer.



Note The user may adjust the device for the stepper mode by defining the one point calibration in the Programs mode. See sections D.2.3, E.5.2, and E.5.3 for more information.

E.5.1 Changing Default Calibration Setting

All Presets and Matrix functions are affected when the Default calibration setting is changed. Default calibration can only be edited under Default user profile (see. D.3.1.5). The Default calibration setting is always a 2-point calibration. Calibration volumes are 10% of the nominal volume and the nominal volume.



Note The Default user may lock the Default calibration setting with a password so that the setting cannot be changed without authorization. See section D.3.1.4 for more information.



Note The user may check the date of the last made Default calibration setting from the Calibration tracker. See section D.3.2.3 for more information.









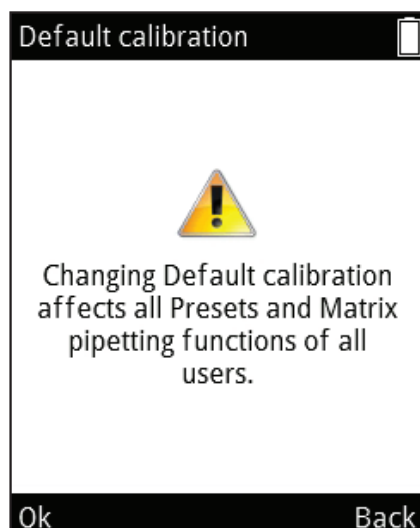



Note It is advised that the performance values for the Default calibration setting are defined according to ISO 8655 procedures in the Forward mode.



Caution When changing the Default calibration settings, all functions under Matrix and Presets are affected in all user profiles.



1. Select  (**Settings**) and press  (**Select**).
2. Select **Calibrate** and press  (**Select**).
3. Select **Default calibration** and press  (**Edit**).
4. A notification will appear to warn about influencing all Presets functions. Accept with  (**Ok**).
5. Change the Actual max. volume to correspond to the obtained calibration maximum volume using  ,  or the **Volume editor**.
6. Scroll to Actual min. volume and change the volume to correspond to the obtained calibration minimum volume using  ,  or the **Volume editor**.
7. Press  (**Done**) when the changes are ready.
8. A confirmation window appears. Accept with  **Yes**. (**No**) will return you to the **Calibrate** menu.
9. The Defaults calibration setting has been changed.
10. Perform re-calibration of the device according to section E.4. to verify the effect of new adjustment settings.
11. Repeat Steps 1-7 if necessary.

















Note If the volume settings are not changed when (**Done**) is pressed, a notification text will appear. Proceeding with (**Ok**) will return to the **Calibrate** menu.



Note If only one of the volume settings has been changed when (**Done**) is pressed, a notification text will appear. Proceeding with (**Yes**) will proceed to confirmation and (**No**) will return to the **Calibrate** menu.

E.5.2 Creating Special Adjustments

A user can store up to 5 different special adjustments that can be used in created programs to improve the application-specific device performance. Created special adjustments only affect the programs that have been defined to use the specific setting.

1. Select  (**Settings**) and press  (**Select**).
2. Select **Calibrate** and press  (**Select**).
3. Select **Add new calibration** and press  (**Add**).
4. Select the type of calibration using  and  : either **One point** or **Two point calibration**.
5. Scroll to **Name**. Edit the default name using  (**Rename**). This opens the character window where the cursor can be moved using the arrow keys. Enter a highlighted character to the name by pressing  (**Select**). Press  (**Done**) when finished.
6. Press  (**Done**).
7. In one point calibration set the Target volume using ,  or use the **Volume editor**. After the Target volume set the Actual volume to correspond to the obtained calibration volume.
8. In two point calibration the Target volume levels are fixed. Change the Actual volumes to correspond to the obtained calibration volumes.
9. When the changes are ready press  (**Done**).
10. A window opens allowing the user to press the trigger.
11. A confirmation window appears. Accept with  (**Yes**).
12. A new adjustment setting has been saved to memory.

The stored special adjustments can be used in the Programs mode where they can be connected to user-created programs (section D.2.3).

After connecting the special adjustment to a program, perform re-calibration of the device according to section E.4.2 to verify the device performance.



Note The acceptance specifications in section E.4.2 apply only when water is dispensed with the Forward pipetting technique.



Note The volume conversion factor Z in section E.4.3.1 applies only to water. Conversion calculations for other liquids need to be done using the density value of the dispensed liquid and applicable formulas.



Note The user may lock the special calibration setting with a password so that the setting cannot be changed without authorization. See section D.3.1.4 for more information.











Caution The user must make sure that the special calibration setting is suitable for the intended liquid transfer operation. Failing to do so may cause serious dosing errors.

E.5.3 Editing Special Adjustments

The stored special adjustments can be edited by the user.



Caution When changing a stored special adjustment, the user-created programs that have been defined to use the setting in question are affected.









1. Select  (**Settings**) and press  (**Select**).
2. Select **Calibrate** and press  (**Select**).
3. Select the adjustment setting to be edited from the list.
4. Highlight the  icon using  and  and press  (**Edit**).
5. Proceed according to section E.5.2. from Step 4 onwards.
6. Press  (**Done**) when the changes are ready.
7. A confirmation window appears. Accept with  (**Yes**).
8. After applying a stored adjustment setting in the Programs mode (section D.2.3), perform re-calibration of the device according to section E.4.2 to verify the effect of new adjustment settings.

E.5.4 Deleting a Stored Adjustment Setting

The stored special adjustment can be deleted by the user.



Caution When deleting a special adjustment, the user-created programs that have been defined to use the setting in question are affected. The programs that have been defined to use the deleted adjustment will automatically be changed to use the Default calibration adjustment setting. A notification of the adjustment setting change will be displayed when the linked program is used the next time. The notification will only appear once.

1. Select  (**Settings**) and press  (**Select**).
2. Select **Calibrate** and press  (**Select**).
3. Select the adjustment setting to be removed.
4. Highlight the  icon using  and  and press  (**Delete**).
5. A confirmation window appears. Accept with  (**Yes**).

F. TROUBLESHOOTING

The table below lists possible symptoms and their solutions.

Defect	Possible reason	Possible action
Leakage	Tip fitting incorrectly attached or loose	Re-attach/tighten the tip fitting or replace with new tip fitting(s) using the tool.
	ClipTip clips are bent	Discard the tip.
	Tip fitting O-ring damaged	Change the O-ring.
	Tip incorrectly attached	Attach firmly.
	Foreign particles between the tip and the tip cone	Clean the tip cones and attach new tips.
	Insufficient amount of grease on the cylinder and the O-ring or foreign particles between the piston, the O-ring and the cylinder	Single channel pipettes: Clean and grease the O-ring and cylinder. Multichannel pipettes: Contact service.
Inaccurate dispensing	Incorrect operation	Follow the instructions carefully.
	Tip incorrectly attached	Attach firmly.
	Unsuitable calibration	Recalibrate according to the instructions.
	Wrong tip	Use the correct tip.
	Tip fitting incorrectly attached or loose	Tighten the tip fitting with the tool or replace the tip fitting set.
Tip not ejecting	Tip fitting incorrectly attached or loose	Open the clips manually with a small sharp tool and pull out the tip. Tighten the tip fitting with the tool or replace the tip fitting set.
	Battery too low	Recharge the battery.
No dispensing	Battery too low	Recharge the battery.
	Pistons stuck	Single channel pipettes: Remove the tip cone module. Move the piston by hand or with the piston removal tool. Re-attach the module. Multichannel pipettes: Contact service.
	Piston not connected in single channel pipette	Attach the module in service mode.

Defect	Possible reason	Possible action
The battery is not charging	Charger cable not attached properly to the pipette	Detach and reconnect properly.
	The charger is not connected to the power supply	Connect the charger to the power supply.
	Pipette not placed properly into the charging stand	Take the pipette out from the charging stand and place it back again properly.
	Charger cable not connected to the charging stand	Connect the charger cable to the charging stand.
	Battery not installed	Install the battery following the instructions in section A.3 Getting Started .









Note Do not perform troubleshooting procedures on the internal components unless instructed by Thermo Fisher Scientific Technical Service personnel.









Warning If the corrective actions do not solve the problem, do not use the pipette. Contact service.

Display Notifications

The user interface of the E1-ClipTip electronic pipette displays various messages in order to guide and assist the user. The most important notifications are listed and explained below.

Display information	Probable cause	Solution
 Battery power lost, press Ok to set date and time.	Battery power was lost or battery was empty.	Set the current date and time.
 Invalid date. Press Ok.	Given date is not up-to-date.	Press Ok and set the current date again.
 Piston position error. Press trigger to empty tips.	Piston movement was not accurate during aspirating or dispensing due to mechanical friction or blockage.	Press the trigger to remove the friction or blockage. Caution! If there is liquid in the tips, it will be dispensed! Notice also that the previous dispensed dose may be inaccurate! Contact service if the error reappears continuously.
 Piston position error.	Pipette is not serviced for a while and mechanical friction prevents accurate operation.	The piston needs to be greased. Contact service.
 Piston adjustment error.	Pipette is not serviced for a while and mechanical friction prevents reliable calibration of the pipette.	The piston needs to be greased. Contact service.
 Battery failure 1.	Battery is not connected. Battery might be worn out, outdated or damaged (battery voltage was too low for charging).	Check that the connector of the battery is attached properly. Contact service for a replacement battery. Do not use the pipette with a defective battery.
 Battery failure 2.	Battery might be worn out, outdated or damaged (battery failed to charge).	Contact service for a replacement battery. Do not use the pipette with a defective battery.

	Battery failure 3.	Battery might be worn out, outdated or damaged (battery overvoltage detected).	Contact service for a replacement battery. Do not use the pipette with a defective battery. Using the pipette with a damaged battery caused by battery failure 3 may cause a potential safety risk (thermal runaway).
	The position sensor was not found.	Connect piston function in service menu of single channel pipette could not detect position sensor.	Repeat the Connect piston function according to the instructions. If it fails again, then contact service.

Display information	Probable cause	Solution
 Battery low. Plug to charger.	Battery voltage level is low.	Charge the pipette. See the instructions.
 Special calibration of this program has been deleted and will be replaced with the Default calibration.	The special calibration that was used in the program in question has been deleted.	If the special calibration was deleted unintentionally, then it has to be recreated. See the instructions.
 Dispensing might be interrupted. Press trigger to empty tips.	Battery power was lost because battery is empty or battery connector was detached.	Press the trigger to the empty tips. Caution! If there is liquid in the tips, it will be dispensed! Notice also that the previous dispensed dose may be inaccurate!
 Dispensing interrupted. Press trigger to empty tips.	Pipette has been re-started unintentionally because of low battery level or some other unexpected event.	Press the trigger to empty the tips. Caution! If there is liquid in the tips, it will be dispensed! Notice also that the previous dispensed dose may be inaccurate!
 Changing Default calibration affects all Presets and Matrix pipetting functions.	Default calibration has been selected to be adjusted.	Be aware that Default calibration is used in all Presets functions and the Matrix function, and in all of the user programs that are not using special calibrations.

G. MAINTENANCE

G.1 Regular and Preventive Maintenance

For reliable daily operation, keep the E1-ClipTip pipette free of dust and away from liquid spills.

Even though the E1-ClipTip pipette is constructed from high-quality materials, you must immediately wipe away spilled saline solutions, solvents, acids or alkaline solutions from outer surfaces to prevent damage.

It is recommended that you clean the case of the pipette periodically to maintain its good appearance. A soft cloth dampened with 70% ethanol solution is adequate. It is also recommended to check the tightness of the tip fittings.



Caution Ethanol should not be sprayed directly on the pipette. This may impair the transparency of the display window. Use only a moistened cloth.



Caution The user should verify the suitability of any other cleaning reagents before proceeding. It is recommended to use only 70% ethanol for cleaning.



Caution Aggressive substances can damage the pipette or pipette parts. Check for material compatibility before handling organic solvents and aggressive chemicals with the pipette.



Warning Use a decontamination solution if any surfaces are contaminated with biohazardous material.



Note It is recommended to use filter tips to avoid contamination of the inner parts of the E1-ClipTip pipette.

G.2 Replacing Tip Fitting and Sealing Ring(s)

If the pipette is used daily, it should be checked every three months. The servicing procedure starts with the disassembly of the pipette.



Caution The E1-ClipTip sealing rings 6 and 7 are wear parts. Clean them after contamination, use of aggressive chemicals or heavy stress. Replace the sealing rings if they are worn or damaged.

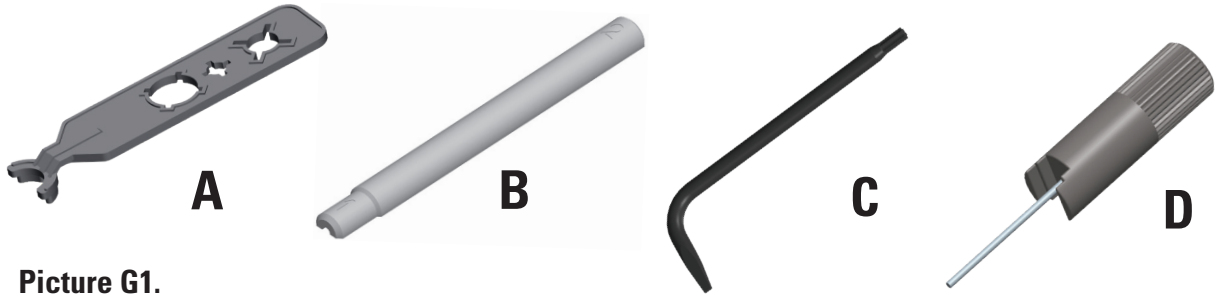

Picture G1.

Removing and replacing tip fitting(s) 5 and sealing ring(s) 6 and 7 in single channel and multichannel pipettes

Single channel and multichannel models from 2-125 μ l to 15-1250 μ l with 96-format tip fitting

Remove tip fitting 5 (Picture G2).

To remove the tip fitting, place the star-shaped end of tool C (picture G1) into the end of the tip fitting. Turn the tool counterclockwise to unscrew the tip fitting (Picture G3a).

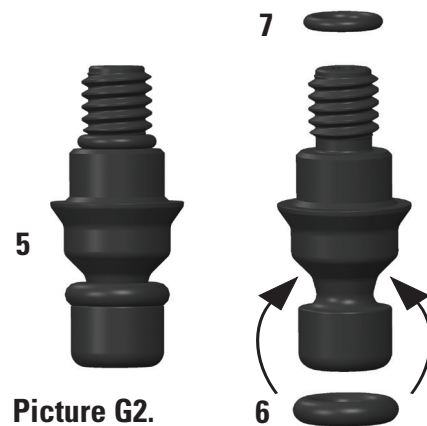

Picture G2.

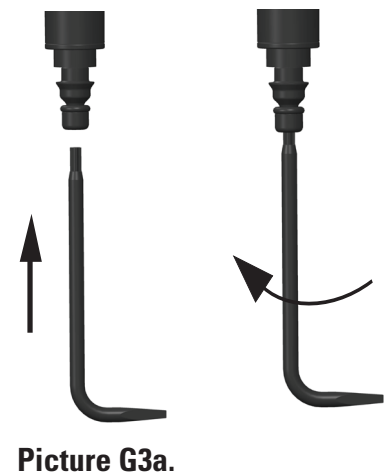

Picture G3a.

Reassembly of tip fitting 5 and o-rings 6 and 7

Make sure that the tip fitting has both o-rings 6 and 7 in place (Picture G2). Change o-rings during maintenance if needed. Place the tip fitting onto the star-shaped end of tool C so that the screw end is facing upwards. Insert the screw end into the cylinder and carefully screw in the tip fitting by turning the tool clockwise. Rotate the tool and tighten the tip fitting. Check to make sure that there is no gap between tip fitting and cylinder (Picture G3b).

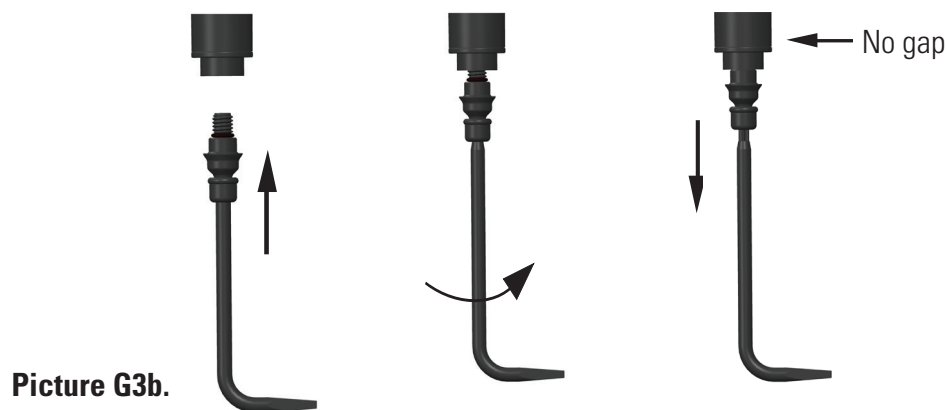

Caution Be careful not to over tighten the tip fitting. This may damage the thread in the pipette.

Single channel model 0.5-12.5 μ l with 384-format tip fitting

1. Remove the tip fitting by hand turning it counterclockwise. Use the metal rod end of the tip fitting tool D to remove the O-ring 7 from the cylinder den for inspection. Replace the O-ring if necessary.
2. Place the tip fitting onto the tool end with a metal rod so that the screw end is upwards. Place the O-ring 7 into the rod above the tip fitting or make sure that the O-ring is at the bottom of the screw den of the cylinder. Replace O-ring if necessary. Align the tool with the cylinder 9 and carefully screw the tip fitting in by using two fingers until you feel resistance. Remove the tool and tighten the tip fitting lightly by using two fingers.



Caution The user must make sure that the small tip fitting O-ring 7 is in place before attaching the tip fitting. The tip fitting tool or a disposable tip can be used to place the O-ring into place. Failing to check this may cause leakage of the pipette.



Note The product package contains spare part sealing rings. Store them for future maintenance purposes.

Multichannel models with 384-format tip fitting



The multichannel pipette models with 384-format tip fitting cannot be disassembled by the user. See Chapter J: [TECHNICAL SERVICE](#) for more information to service your pipette.

G.3 Disassembly and Assembly

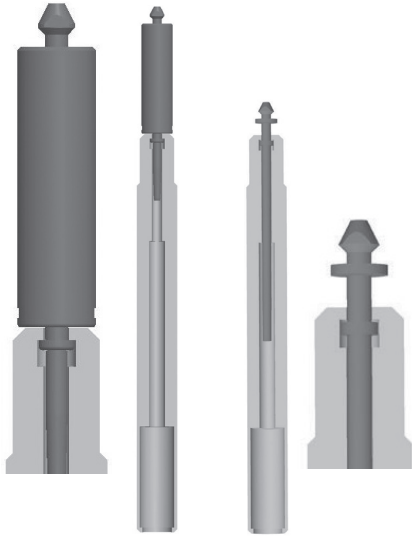
G.3.1 Single Channel Pipettes – Disassembly



Picture G4.

1. Remove the tip fitting 5 as described in section G.2.
2. Remove the tip ejector 8 by rotating it counterclockwise.
3. Remove the cylinder 9 using a corresponding slot in the tool A. Turn clockwise to open the screw joint and pull out the cylinder module (Picture G4). Use the tool end 1 for models 12.5 μ l, 125 μ l and 1250 μ l and the tool end 2 for model 300 μ l.
4. Select  (**Settings**) and press  (**Select**) in the main menu of the pipette.
5. Select **Connect piston** from the list and press  (**Select**) (Picture G5).
6. Press and hold the **trigger** down to drive out the piston.
7. Insert the piston tool B and pull out the piston 12. Release the **trigger**.
8. Turn the tip cone upside down and tap all the parts from it. You can check the parts of each pipette model from the pictures in Appendix 4. Remember to keep all the parts in order on the table for reassembly.



Picture G5.

G.3.2 Single Channel Pipettes – Cleaning

Clean the piston, piston spring, and sealing rings with a dry lint-free cloth.

Clean the parts with a suitable cleaning solution by immersing item in a 70% ethanol solution, for example, or wiping them with a dampened cloth. Dry before assembly.

Grease the spring, sealing ring and piston with the lubricant that comes with the pipette.





Caution Do not grease the tip fitting sealing ring 6. This may collect dirt and cause leaking of the pipette.



G.3.3 Single Channel Pipettes – Assembly

The pipette is assembled in the reverse order to disassembling. See the model specific explosion pictures in Appendix 4 for assistance.



Model 0.5-12.5µl

1. Slide the spring 18, spring support 19 and sealing ring 20 on to the tube 17.
2. Slide the spring support 13, tube 14, bigger sealing ring 15, smaller sealing ring 16 and previous tube assembly 17 on the piston 12.
3. Carefully slide the assembly into the cylinder 9.
4. Place the spring support 10 on to the other end of the spring 11.
5. Place the free end of the spring 11 against the spring support 13 installed into the cylinder.
6. Carefully slide the assembly to the handle and screw the cylinder clockwise until it stops.
7. Use the tool A to lightly tighten the cylinder into the handle.
8. Insert the tip ejector assembly 8 into the handle and turn clockwise until it stops. You should feel a snap, when the tip ejector is correctly placed.
9. Insert the tip fitting 5 as described in section G.2.
10. Select  (**Settings**) and press  (**Select**) in the main menu of the pipette.
11. Select **Connect piston** from the list and press  (**Select**).
12. Press and hold the **trigger** down to connect the motor coupler to the piston.

Models 2-125µl and 10-300µl

1. Place the spring support 10, spring 11, support 13 and sealing ring 15 on the piston 12.
2. Carefully slide the assembly into the tip cone 9.
3. Insert the entire assembly into the handle and turn it tight by hand. Use the tool A to lightly tighten the cylinder into the handle.
4. Insert the tip ejector assembly 8 into the handle and turn until the assembly drops into the correct place. When correctly positioned, the tip ejector only rotates 45°. Make sure that the tip ejector is turned in the clockwise direction until it stops. You should feel a snap, when the tip ejector is correctly placed.
5. Insert the tip fitting 5 as described in section G.2.
6. Select  (**Settings**) and press  (**Select**) in the main menu of the pipette.
7. Select **Connect piston** from the list and press  (**Select**).
8. Press and hold the **trigger** down to connect the motor coupler to the piston.

Model 15-1250µl

1. Place the spring support 10, spring 11, support 13 and sealing ring 15 on the piston assembly 12.
2. Carefully slide the assembly into the tip cone 9.
3. Insert the entire assembly into the handle and turn it tight by hand. Use the tool A to lightly tighten the cylinder into the handle.
4. Insert the tip ejector assembly 8 into the handle and turn until the assembly drops into the correct place. When correctly positioned, the tip ejector only rotates 45°. Make sure that the tip ejector is turned in the clockwise direction until it stops. You should feel a snap, when the tip ejector is correctly placed.
5. Insert the tip fitting 5 as described in section G.2.
6. Select  (**Settings**) and press  (**Select**) in the main menu of the pipette.
7. Select **Connect piston** from the list and press  (**Select**).
8. Press and hold the **trigger** down to connect the motor coupler to the piston.



Caution The user must make sure that the piston sealing rings are intact before assembly and replace them if necessary. Failing to check this may cause leakage of the pipette.



Caution The user must make sure that the small tip fitting O-ring 7 is in place before attaching the tip fitting. The tip fitting tool or a disposable tip can be used to place the O-ring into place. Failing to check this may cause leakage of the pipette.

G.3.4 Multi Channel Pipettes

The user may remove and clean the tip fittings and sealing rings of 96-format multichannel pipettes and change them as described in section G.2. if found necessary.

384-format multichannel pipettes cannot be disassembled by the user. Only the outside surfaces can be cleaned.

In case of malfunctioning or a suspicion of damage to the lower parts of the pipette, contact the closest service representative (Chapter [J. TECHNICAL SERVICE](#)).



Caution Servicing of the multichannel pipette handles should only be performed by trained and authorized personnel. Disassembly of multichannel pipettes may cause malfunctioning of the device if not executed by a professional.

G.4 Decontamination Procedure

The display, keypad, handle and lower parts of the E1-ClipTip pipette as well as the tip fittings of 384-model multichannels can be wiped with decontaminants that are recommended below. These parts must not be immersed in liquid.

Removable tip fittings (**see sections G2 and G3 for disassembly**) can be immersed in the decontaminant solution according to the table below. Afterwards the parts must be thoroughly rinsed with distilled water and allowed to dry before reassembling.

Recommended decontamination solutions for the E1-ClipTip pipette.

	Display and keypad	Handle	Lower parts	Tip fittings and sealing rings
Ethanol 70%	X	X	X	X
Virkon solution 1%	X	X	X	X
Sodium hypochlorite (5%)	X	X	X	-
Glutaraldehyde (2.5%)	X	X	X	X
Hydrogen peroxide (7.5%)	-	X	-	X

X : The parts are chemically resistant to the decontaminant.

- : The parts are not chemically resistant to the decontaminant.



Caution The effectiveness of the decontamination procedure must be verified by the user.

G.5 Autoclaving

Steam sterilization should be performed at 121°C (252°F) and 2 ata for 20 minutes. Sterilization bags may be used if needed.

Steam sterilization can be performed on the following parts:

With single channel pipettes

- cylinder module
- piston assembly
- tip ejector assembly
- tip fitting (both 96-format and 384-format tip fitting) and sealing rings



Caution The cylinder should be kept inside the tip ejector assembly during autoclaving. The tip fitting should be kept detached.

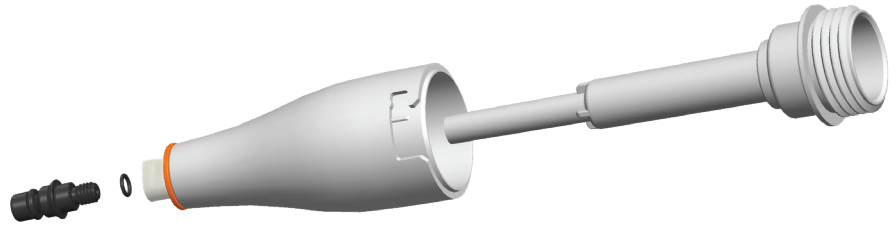

With multichannel pipettes:

- tip fittings (only 96-format tip fittings) and sealing rings

Other parts cannot be steam sterilized.



Caution The user must verify the effectiveness of the autoclaving.

After autoclaving, the tip cone and tip fitting must be cooled to room temperature for at least two hours before assembly and any operations. Before pipetting, make sure that the tip cone and tip fitting are dry.

G.6 Disposal of Materials

G.6.1 Disposal of the Materials

Follow laboratory and country-specific procedures for the disposal of biohazardous or radioactive waste. Refer to local regulations for the disposal of infectious material.



Warning The tips can be potentially infectious. Dispose of all used disposable tips as biohazardous waste.



Note The pipette should be regularly serviced according to the User Manual.

The pipette calibration and functioning must be checked after maintenance.

Use only original Thermo Scientific spare parts and ClipTips.

Avoid excess grease. Use only the grease provided with the pipette.

The pipette should be checked at the beginning of each day. Particular attention should be paid to the tip cone.

It is recommended to 70% ethanol for wiping the pipette.
If the pipette is used daily, it is recommended to service the pipette every three months.

G.6.2 Disposal of the Pipette

Follow the guidelines below for the disposal of the E1-ClipTip pipette .



Warning Decontaminate the pipette before disposal. Refer to section G.4.

Follow laboratory and country-specific procedures for biohazardous or radioactive waste disposal.



Warning The used lithium (Li-ion) battery is regulated waste and must be disposed of according to local regulations.



Dispose of the instrument according to the legislation stipulated by the local authorities concerning take-back of electronic equipment and waste. The procedures vary by country.

Pollution degree: 2 according to IEC 60664-1 *

Method of disposal:

- Electronic waste
- Contaminated waste
- (Infectious waste)

Regarding the original packaging and packing materials, use the recycling operators known to you.

For more information, contact your local Thermo Fisher Scientific representative.

*) The pollution degree describes the amount of conductive pollution present in the operating environment. Pollution degree 2 assumes that normally only nonconductive pollution, such as dust, occurs with the exception of occasional conductivity caused by condensation.

G.7 Spare Parts

The spare parts available for each pipette model can be found in Appendix 4. Contact your local Thermo Fisher Scientific dealer for part orders.

H. TECHNICAL DATA

Battery

Type:	Li-ion battery
Capacity:	1230 mAh
Charging time:	Approx. 2 h
Charging temperature:	0 to +40°C

Power supply unit

Type:	Switching power supply
Input voltage:	100-240 V ~50/60 Hz, 300 mA max.
Output voltage:	5.0 V \pm 800 mA max.

Display

Type:	Color TFT-LCD
Size:	2.2"
Resolution:	176 x 220 pixels

E1-ClipTip pipette

E1-ClipTip pipette	Type: 154
E1-ClipTip pipette BT	Type: 155
Weight with battery (tip not included):	Single channel pipette 190 g max. Multichannel pipette 320 g max.
Operating temperature:	+15 to +35°C
Air humidity during operation:	20 to 85% rel. humidity
Storage temperature:	\leq 1 month -20 to +45°C (60 \pm 25% Rel. humidity) > 1 month -10 to +35°C (60 \pm 25% Rel. humidity)

It is recommended to charge the pipette every two months even if the pipette is not used.

Wireless connectivity of E1-ClipTip BT

Type:	Bluetooth® 2.1 + EDR
Transmit power:	4 dBm max. / Class 2
Range:	Approximately 10 m depending on obstacles and interference from equipment such as microwave ovens and other wireless devices.

Contains transmitter module
FCC ID: T7VEBMU / IC: 216QEBMU

Materials

E1-ClipTip Pipettes

Material	Component
----------	-----------

External surfaces of the upper parts:

PA	polyamide
PMMA	polymethyl methacrylate
ABS	acrylonitrile butadiene styrene

Exterior and interior of the lower parts:

PEI	polyetherimide
PA	polyamide
PVDF	polyvinylidenefluoride
EPDM	ethylene-propylene-diene rubber
FVM	fluorosilicone rubber
Steel	stainless steel
POM	polyoxymethylene
PEEK	polyether ether ketone
PVC	polyvinyl chloride
PP	polypropylene
Silicone	
Brass	
PPSU	Polyphenylsulfone

ClipTip Tips

Tip	PP	polypropylene
Filters	PE	polyethylene

I. WARRANTY

Thermo Scientific E1-ClipTip Electronic Pipette

Warranty Certificate

All Thermo Scientific™ E1-ClipTip™ electronic pipettes are guaranteed to be free of defects in material and workmanship for a period of two years from the date of purchase.

Register Online at www.thermoscientific.com/pipettewarranty

Thermo Fisher Scientific will replace or repair the defective product upon prompt notification in compliance with the following conditions. The warranty against defects in workmanship or materials will be honored as long as the product was used in compliance with the instructions for use and care. The warranty does not apply to products exposed to physical or chemical abuse.

The Warranty is subject to the following conditions

1. A 2-year warranty applies for pipettes that have been registered, and a 1-year warranty for non-registered ones.
2. The warranty registration certificate and proof of purchase **MUST** be presented to Thermo Fisher Scientific or its distributor when making a claim for replacement.
3. The customer must give notice to Thermo Fisher Scientific or its distributor in writing immediately after discovery of the defect.
4. If requested, the product must be returned to Thermo Fisher Scientific or its distributor. The product must be adequately packed and fully insured, and all shipping fees must be paid.
5. Our responsibility extends only to product defects. The warranty does not apply if, in the opinion of Thermo Fisher Scientific, the product has been damaged by accident, misuse or chemical or physical abuse – or by service or modifications by someone other than a service provider of Thermo Fisher Scientific.
6. During the Warranty period non-wearable parts are covered 100%. Non-wearable parts are effectively parts that are designed to last for the life of the product. Wearable parts are parts that will wear under normal operation (such as O-rings and battery). These parts are not covered under the Warranty.
7. Routine cleaning and recalibration are not covered under the terms of the Warranty.
8. Validity may vary by country. To check your country specific warranty claims, go to www.thermoscientific.com/pipettewarranty.

Quality Statement

We hereby certify, that all Thermo Scientific E1-ClipTip pipettes released for delivery have been manufactured and inspected according to our approved documents and procedures. During inspection pipettes have fulfilled the Thermo Fisher Scientific's performance specifications, which conform to ISO 8655 standards. Before released for delivery, all pipettes are factory calibrated using purified water under conditions given in the calibration report and adjusted to give the volumes as specified. Calibration balances are regularly serviced and checked with weights traceable to national and international standards. As a mark of this, a calibration report covering the test results is delivered together with the pipette. Thermo Fisher Scientific Oy's operation system is certified by a third party auditor and conforms to the quality system standard ISO 9001 and environmental system standard ISO 14001.

WARNING! MOST COUNTRIES PROHIBIT THE SHIPMENT OF MATERIALS CONTAMINATED BY RADIOACTIVITY OR HAZARDOUS ORGANIC OR CHEMICAL COMPOUNDS WITHOUT A PERMIT. ALL PIPETTES MUST BE PROPERLY DECONTAMINATED BEFORE THEY ARE RETURNED.

J. TECHNICAL SERVICE

In addition to normal maintenance, it is recommended to service the instrument regularly at least every 12 months by the manufacturer's trained service engineers. This ensures that the product is properly maintained and provides trouble-free functionality. Contact the Thermo Fisher Scientific technical service department for more details. See the list below for contact information.

J.1 Packing for Service



When sending the pipette for service, follow the guidelines presented below.

Warning Health risk from contaminated device. It is important that the instrument is thoroughly decontaminated before it is removed from the laboratory or any servicing is performed on it. Guidelines for decontamination can be found in Chapter [G: MAINTENANCE](#).

When you ship the instrument for service, remember to:

- Inform about the use of hazardous materials.
- Use the original packaging to ensure that no damage will occur to the instrument during shipping. Any damage will incur additional labor charges.
- Enclose a dated and signed decontamination declaration (request from your service provider) inside and attached to the outside of the package, in which you return your instrument (or other items).
- Enclose the return goods authorization number (RGA) given by your Thermo Fisher Scientific representative.
- Indicate the fault after you have contacted your local Thermo Fisher Scientific representative or Thermo Fisher Scientific's technical service department.

Refer to Chapter [H: TECHNICAL DATA](#) for details on storage temperatures.

Appendix 1. Conversion Table

Value of the conversion factor Z ($\mu\text{l}/\text{mg}$), as a function of temperature and pressure, for distilled water.

Temperature °C	Air pressure kPa						
	80	85	90	95	100	101.3	105
15.0	1.0017	1.0018	1.0019	1.0019	1.0020	1.0020	1.0020
15.5	1.0018	1.0019	1.0019	1.0020	1.0020	1.0020	1.0021
16.0	1.0019	1.0020	1.0020	1.0021	1.0021	1.0021	1.0022
16.5	1.0020	1.0020	1.0021	1.0021	1.0022	1.0022	1.0022
17.0	1.0021	1.0021	1.0022	1.0022	1.0023	1.0023	1.0023
17.5	1.0022	1.0022	1.0023	1.0023	1.0024	1.0024	1.0024
18.0	1.0022	1.0023	1.0023	1.0024	1.0025	1.0025	1.0025
18.5	1.0023	1.0024	1.0024	1.0025	1.0025	1.0026	1.0026
19.0	1.0024	1.0025	1.0025	1.0026	1.0026	1.0027	1.0027
19.5	1.0025	1.0026	1.0026	1.0027	1.0027	1.0028	1.0028
20.0	1.0026	1.0027	1.0027	1.0028	1.0028	1.0029	1.0029
20.5	1.0027	1.0028	1.0028	1.0029	1.0029	1.0030	1.0030
21.0	1.0028	1.0029	1.0029	1.0030	1.0031	1.0031	1.0031
21.5	1.0030	1.0030	1.0031	1.0031	1.0032	1.0032	1.0032
22.0	1.0031	1.0031	1.0032	1.0032	1.0033	1.0033	1.0033
22.5	1.0032	1.0032	1.0033	1.0033	1.0034	1.0034	1.0034
23.0	1.0033	1.0033	1.0034	1.0034	1.0035	1.0035	1.0036
23.5	1.0034	1.0035	1.0035	1.0036	1.0036	1.0036	1.0037
24.0	1.0035	1.0036	1.0036	1.0037	1.0037	1.0038	1.0038
24.5	1.0037	1.0037	1.0038	1.0038	1.0039	1.0039	1.0039
25.0	1.0038	1.0038	1.0039	1.0039	1.0040	1.0040	1.0040
25.5	1.0039	1.0040	1.0040	1.0041	1.0041	1.0041	1.0042
26.0	1.0040	1.0041	1.0041	1.0042	1.0042	1.0043	1.0043
26.5	1.0042	1.0042	1.0043	1.0043	1.0044	1.0044	1.0044
27.0	1.0043	1.0044	1.0044	1.0045	1.0045	1.0045	1.0046
27.5	1.0045	1.0045	1.0046	1.0046	1.0047	1.0047	1.0047
28.0	1.0046	1.0046	1.0047	1.0047	1.0048	1.0048	1.0048
28.5	1.0047	1.0048	1.0048	1.0049	1.0049	1.0050	1.0050
29.0	1.0049	1.0049	1.0050	1.0050	1.0051	1.0051	1.0051
29.5	1.0050	1.0051	1.0051	1.0052	1.0052	1.0052	1.0053
30.0	1.0052	1.0052	1.0053	1.0053	1.0054	1.0054	1.0054

Appendix 2. Manufacturer Factory Specification Limits

E1-ClipTip Single Channel models

Cat. No.	Range µl	Volume µl	Inaccuracy		Imprecision		ClipTip
			µl	%	std µl	CV%	
4670000	0.5–12.5	12.50	±0.125	±1.00	0.050	0.40	ClipTip 12.5
4670000BT		6.25	±0.063	±1.00	0.050	0.80	
		1.25	±0.050	±4.00	0.050	4.00	
4670020	2.0–125.0	125.00	±0.75	±0.60	0.25	0.20	ClipTip 200
4670020BT		62.50	±0.375	±0.60	0.125	0.20	
		12.50	±0.30	±2.40	0.10	0.80	
4670030	10.0–300.0	300.00	±1.8	±0.60	0.45	0.15	ClipTip 300
4670030BT		150.00	±0.9	±0.60	0.225	0.15	
		30.00	±0.5	±1.67	0.15	0.50	
4670040	15.0–1250.0	1250.00	±6.0	±0.48	1.625	0.13	ClipTip 1250
4670040BT		625.00	±3.125	±0.50	0.813	0.13	
		125.00	±3.0	±2.40	0.6	0.48	

E1-ClipTip Multichannel models

Cat. No.	Channels	Range µl	Volume µl	Inaccuracy		Imprecision		ClipTip
				µl	%	std µl	CV%	
4671000	8-ch	0.5–12.5	12.50	±0.313	±2.50	0.200	1.60	ClipTip 12.5
4671000BT			6.25	±0.156	±2.50	0.150	2.40	
			1.25	±0.150	±12.00	0.150	12.00	
4671040	8-ch	2.0–125.0	125.00	±2.50	±2.00	0.75	0.60	ClipTip 200
4671040BT			62.50	±1.25	±2.00	0.80	1.28	
			12.50	±1.00	±8.00	0.50	4.00	
4671070	8-ch	10.0–300.0	300.00	±6.0	±2.00	1.8	0.60	ClipTip 300
4671070BT			150.00	±3.0	±2.00	1.2	0.80	
			30.00	±1.5	±5.00	0.6	2.00	
4671100	8-ch	15.0–1250.0	1250.00	±18.0	±1.44	7.5	0.60	ClipTip 1250
4671100BT			625.00	±9.375	±1.50	3.75	0.60	
			125.00	±5.0	±4.00	1.88	1.50	
4671010	12-ch	0.5–12.5	12.50	±0.313	±2.50	0.200	1.60	ClipTip 12.5
4671010BT			6.25	±0.156	±2.50	0.150	2.40	
			1.25	±0.150	±12.00	0.150	12.00	
4671050	12-ch	2.0–125.0	125.00	±2.50	±2.00	0.75	0.60	ClipTip 200
4671050BT			62.50	±1.25	±2.00	0.80	1.28	
			12.50	±1.00	±8.00	0.50	4.00	
4671080	12-ch	10.0–300.0	300.00	±6.0	±2.00	1.8	0.60	ClipTip 300
4671080BT			150.00	±3.0	±2.00	1.2	0.80	
			30.00	±1.5	±5.00	0.6	2.00	

4671090	12-ch	30.0–850.0	850.00	±12.75	±1.50	5.1	0.60	ClipTip 1000
4671090BT			425.00	±6.375	±1.50	2.55	0.60	
			85.00	±4.0	±4.71	1.7	2.00	
4671020	16-ch	0.5–12.5	12.50	±0.313	±2.50	0.200	1.60	ClipTip 12.5
4671020BT			6.25	±0.156	±2.50	0.150	2.40	384
			1.25	±0.150	±12.00	0.150	12.00	
4671030	16-ch	1.0–30.0	30.00	±0.60	±2.00	0.27	0.90	ClipTip 30
4671030BT			15.00	±0.30	±2.00	0.30	2.00	384
			3.00	±0.30	±10.00	0.21	7.00	
4671060	16-ch	2.0–125.0	125.00	±2.50	±2.00	0.75	0.60	ClipTip 125
4671060BT			62.50	±1.25	±2.00	0.80	1.28	384
			12.50	±1.00	±8.00	0.50	4.00	

E1-ClipTip Adjustable Tip Spacing Equalizer Multichannel models

Cat. No.	Channels	Range µl	Volume µl	Inaccuracy		Imprecision		ClipTip
				µl	%	std µl	CV%	
4672050	96 format, 8-ch	2.0–125.0	125.00	±2.50	±2.00	0.75	0.60	ClipTip 200
4672050BT			62.50	±1.25	±2.00	0.80	1.28	
			12.50	±1.00	±8.00	0.50	4.00	
4672080	96 format, 8-ch	10.0–300.0	300.00	±6.0	±2.00	1.8	0.60	ClipTip 300
4672080BT			150.00	±3.0	±2.00	1.2	0.80	
			30.00	±1.5	±5.00	0.6	2.00	
4672090	96 format, 6-ch	15.0–1250.0	1250.00	±18.00	±1.44	7.5	0.60	ClipTip 1250
4672090BT			625.00	±9.375	±1.50	3.75	0.60	
			125.00	±5.0	±4.00	1.88	1.50	
4672100	96 format, 8-ch	15.0–1250.0	1250.00	±18.00	±1.44	7.5	0.60	ClipTip 1250
4672100BT			625.00	±9.375	±1.50	3.75	0.60	
			125.00	±5.0	±4.00	1.88	1.50	
4672010	384 format, 8-ch	0.5–12.5	12.50	±0.313	±2.50	0.200	1.60	ClipTip 12.5
4672010BT			6.25	±0.156	±2.50	0.150	2.40	384
			1.25	±0.150	±12.00	0.150	12.00	
4672030	384 format, 8-ch	1.0–30.0	30.00	±0.60	±2.00	0.27	0.90	ClipTip 30
4672030BT			15.00	±0.30	±2.00	0.30	2.00	384
			3.00	±0.30	±10.00	0.21	7.00	
4672060	384 format, 8-ch	2.0–125.0	125.00	±2.50	±2.00	0.75	0.60	ClipTip 125
4672060BT			62.50	±1.25	±2.00	0.80	1.28	384
			12.50	±1.00	±8.00	0.50	4.00	
4672020	384 format, 12-ch	0.5–12.5	12.50	±0.313	±2.50	0.200	1.60	ClipTip 12.5
4672020BT			6.25	±0.156	±2.50	0.150	2.40	384
			1.25	±0.150	±12.00	0.150	12.00	
4672040	384 format, 12-ch	1.0–30.0	30.00	±0.60	±2.00	0.27	0.90	ClipTip 30
4672040BT			15.00	±0.30	±2.00	0.30	2.00	384
			3.00	±0.30	±10.00	0.21	7.00	
4672070	384 format, 12-ch	2.0–125.0	125.00	±2.50	±2.00	0.75	0.60	ClipTip 125
4672070BT			62.50	±1.25	±2.00	0.80	1.28	384
			12.50	±1.00	±8.00	0.50	4.00	

Appendix 3. ISO8655 Calibration Specification Limits

E1-ClipTip Single Channel models

Cat. No.	Range μl	Volume μl	Inaccuracy		Imprecision		ClipTip
			μl	%	std μl	CV%	
4670000	0.5–12.5	12.50	± 0.200	± 1.60	0.100	0.80	ClipTip 12.5
4670000BT		6.25	± 0.200	± 3.20	0.100	1.60	
		1.25	± 0.200	± 16.00	0.100	8.00	
4670020	2.0–125.0	125.00	± 1.60	± 1.28	0.60	0.48	ClipTip 200
4670020BT		62.50	± 1.60	± 2.56	0.60	0.96	
		12.50	± 1.60	± 12.80	0.60	4.80	
4670030	10.0–300.0	300.00	± 4.0	± 1.33	1.50	0.50	ClipTip 300
4670030BT		150.00	± 4.0	± 2.67	1.50	1.00	
		30.00	± 4.0	± 13.33	1.50	5.00	
4670040	15.0–1250.0	1250.00	± 16.00	± 1.28	6.0	0.48	ClipTip 1250
4670040BT		625.00	± 16.00	± 2.56	6.0	0.96	
		125.00	± 16.00	± 12.80	6.0	4.80	

E1-ClipTip Multichannel models

Cat. No.	Channels	Range μl	Volume μl	Inaccuracy		Imprecision		ClipTip
				μl	%	std μl	CV%	
4671000	8-ch	0.5–12.5	12.50	± 0.400	± 3.20	0.200	1.60	ClipTip 12.5
4671000BT			6.25	± 0.400	± 6.40	0.200	3.20	
			1.25	± 0.400	± 32.00	0.200	16.00	
4671040	8-ch	2.0–125.0	125.00	± 3.20	± 2.56	1.20	0.96	ClipTip 200
4671040BT			62.50	± 3.20	± 5.12	1.20	1.92	
			12.50	± 3.20	± 25.60	1.20	9.60	
4671070	8-ch	10.0–300.0	300.00	± 8.0	± 2.67	3.0	1.00	ClipTip 300
4671070BT			150.00	± 8.0	± 5.33	3.0	2.00	
			30.00	± 8.0	± 26.67	3.0	10.00	
4671100	8-ch	15.0–1250.0	1250.00	± 32.00	± 2.56	12.0	0.96	ClipTip 1250
4671100BT			625.00	± 32.00	± 5.12	12.0	1.92	
			125.00	± 32.00	± 25.60	12.0	9.60	
4671010	12-ch	0.5–12.5	12.50	± 0.400	± 3.20	0.200	1.60	ClipTip 12.5
4671010BT			6.25	± 0.400	± 6.40	0.200	3.20	
			1.25	± 0.400	± 32.00	0.200	16.00	
4671050	12-ch	2.0–125.0	125.00	± 3.20	± 2.56	1.20	0.96	ClipTip 200
4671050BT			62.50	± 3.20	± 5.12	1.20	1.92	
			12.50	± 3.20	± 25.60	1.20	9.60	
4671080	12-ch	10.0–300.0	300.00	± 8.0	± 2.67	3.0	1.00	ClipTip 300
4671080BT			150.00	± 8.0	± 5.33	3.0	2.00	
			30.00	± 8.0	± 26.67	3.0	10.00	

4671090	12-ch	30.0–850.0	850.00	±16.00	±1.88	6.0	0.71	ClipTip 1000
4671090BT			425.00	±16.00	±3.76	6.0	1.41	
			85.00	±16.00	±18.82	6.0	7.06	
4671020	16-ch	0.5–12.5	12.50	±0.400	±3.20	0.200	1.60	ClipTip 12.5 384
4671020BT			6.25	±0.400	±6.40	0.200	3.20	
			1.25	±0.400	±32.00	0.200	16.00	
4671030	16-ch	1.0–30.0	30.00	±1.00	±3.33	0.40	1.33	ClipTip 30 384
4671030BT			15.00	±1.00	±6.67	0.40	2.67	
			3.00	±1.00	±33.33	0.40	13.33	
4671060	16-ch	2.0–125.0	125.00	±3.20	±2.56	1.20	0.96	ClipTip 200
4671060BT			62.50	±3.20	±5.12	1.20	1.92	
			12.50	±3.20	±25.60	1.20	9.60	

E1-ClipTip Adjustable Tip Spacing Equalizer Multichannel models

Cat. No.	Channels	Range µl	Volume µl	Inaccuracy µl	%	Imprecision std µl	CV%	ClipTip
4672050	96 format, 8-ch	2.0–125.0	125.00	±3.20	±2.56	1.20	0.96	ClipTip 200
4672050BT			62.50	±3.20	±5.12	1.20	1.92	
			12.50	±3.20	±25.60	1.20	9.60	
4672080	96 format, 8-ch	10.0–300.0	300.00	±8.0	±2.67	3.0	1.00	ClipTip 300
4672080BT			150.00	±8.0	±5.33	3.0	2.00	
			30.00	±8.0	±26.67	3.0	10.00	
4672090	96 format, 6-ch	15.0–1250.0	1250.00	±32.00	±2.56	12.0	0.96	ClipTip 1250
4672090BT			625.00	±32.00	±5.12	12.0	1.92	
			125.00	±32.00	±25.60	12.0	9.60	
4672100	96 format, 8-ch	15.0–1250.0	1250.00	±32.00	±2.56	12.0	0.96	ClipTip 1250
4672100BT			625.00	±32.00	±5.12	12.0	1.92	
			125.00	±32.00	±25.60	12.0	9.60	
4672010	384 format, 8-ch	0.5–12.5	12.50	±0.400	±3.20	0.200	1.60	ClipTip 12.5 384
4672010BT			6.25	±0.400	±6.40	0.200	3.20	
			1.25	±0.400	±32.00	0.200	16.00	
4672030	384 format, 8-ch	1.0–30.0	30.00	±1.00	±3.33	0.40	1.33	ClipTip 30 384
4672030BT			15.00	±1.00	±6.67	0.40	2.67	
			3.00	±1.00	±33.33	0.40	13.33	
4672060	384 format, 8-ch	2.0–125.0	125.00	±3.20	±2.56	1.20	0.96	ClipTip 125 384
4672060BT			62.50	±3.20	±5.12	1.20	1.92	
			12.50	±3.20	±25.60	1.20	9.60	
4672020	384 format, 12-ch	0.5–12.5	12.50	±0.400	±3.20	0.200	1.60	ClipTip 12.5 384
4672020BT			6.25	±0.400	±6.40	0.200	3.20	
			1.25	±0.400	±32.00	0.200	16.00	
4672040	384 format, 12-ch	1.0–30.0	30.00	±1.00	±3.33	0.40	1.33	ClipTip 30 384
4672040BT			15.00	±1.00	±6.67	0.40	2.67	
			3.00	±1.00	±33.33	0.40	13.33	
4672070	384 format, 12-ch	2.0–125.0	125.00	±3.20	±2.56	1.20	0.96	ClipTip 125 384
4672070BT			62.50	±3.20	±5.12	1.20	1.92	
			12.50	±3.20	±25.60	1.20	9.60	

Appendix 4. Spare Parts and Accessories

Multichannel pipettes

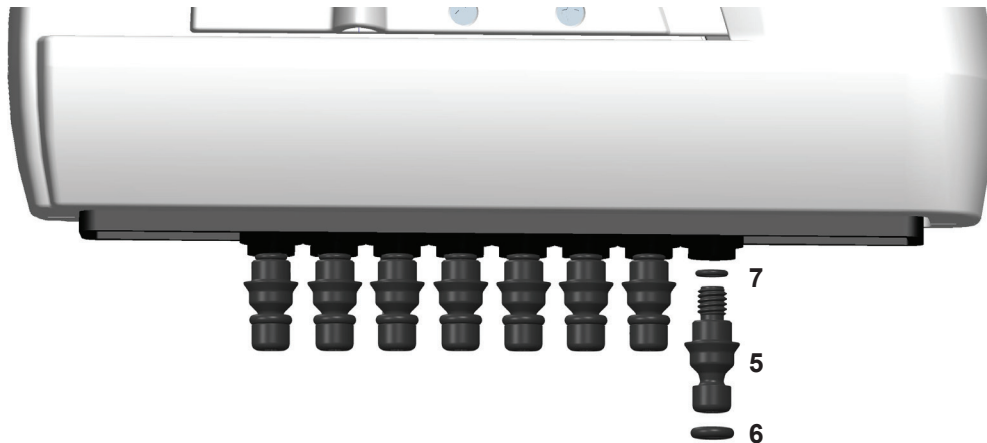

96-format models 125 μ l and 300 μ l

- 5. 2216170 Tip fitting 300 Assy **8 pcs**
- 5. 2216180 Tip fitting 300 Assy **12 pcs**
- 6. 2214920 Tip fitting sealing ring 300 **12 pcs**
- 7. 1033430 Sealing ring small

96-format models 850 μ l and 1250 μ l

- 5. 2216200 Tip fitting 1250 Assy **8 pcs**
- 5. 2216210 Tip fitting 1250 Assy **12 pcs**
- 6. 2214945 Tip fitting sealing ring 1250 **12 pcs**
- 7. 1033430 Sealing ring small

Single channel pipettes

*Available as spare part. See model specific order numbers.

0.5–12.5 µl

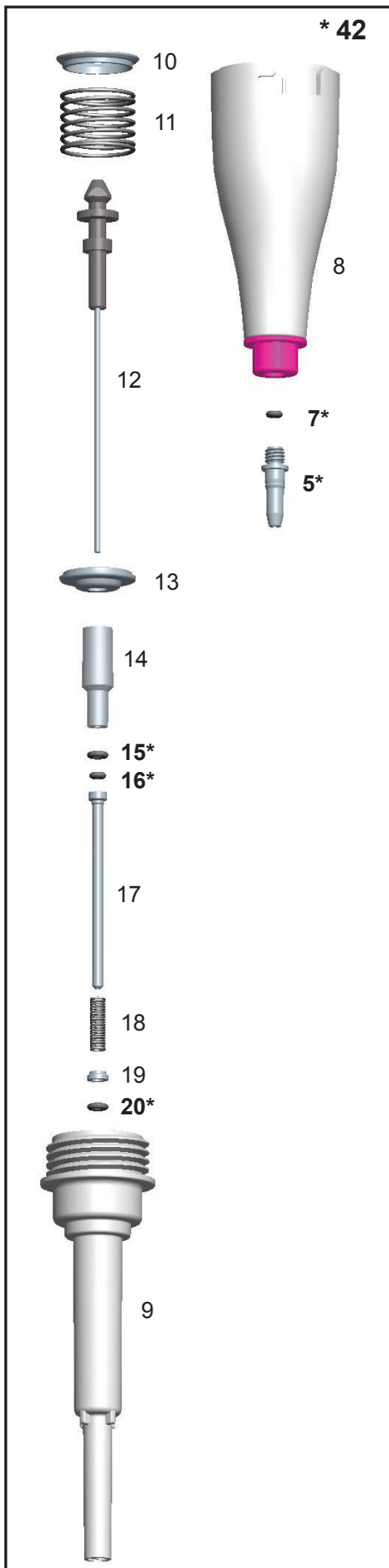

2–125 µl

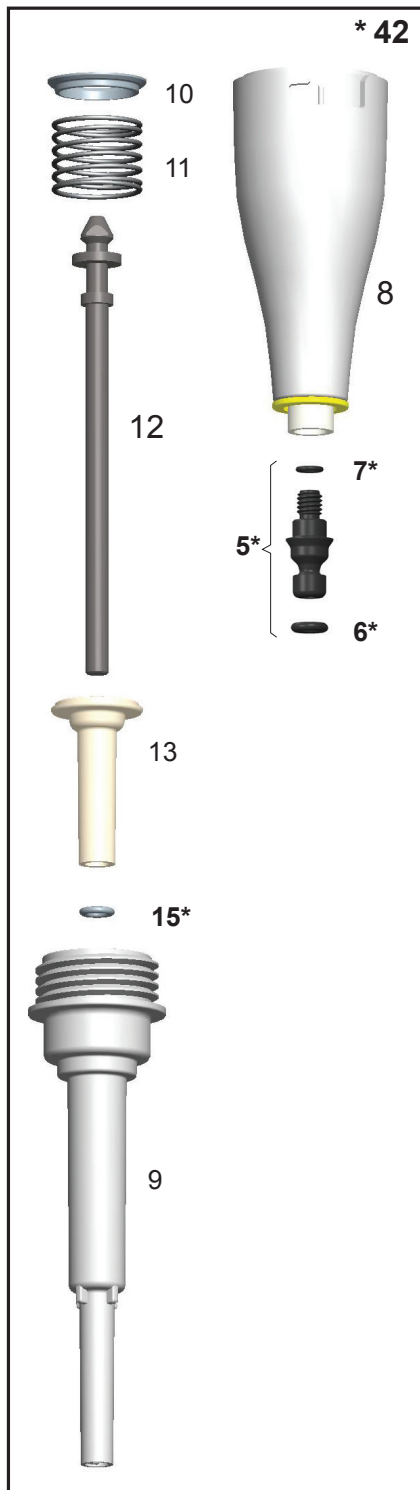

0.5–12.5 µl

- 5. 1064960
- 7. 1030060
- 15. 1030380
- 16. 1030060
- 20. 1030170
- 42. 2215610

2–125 µl

- 5. 2216160 4 pcs
- 6. 2214930 3 pcs
- 7. 1033430
- 15. 1033380
- 42. 2215590N



* 42. Tip cone assembly

10–300 μ l

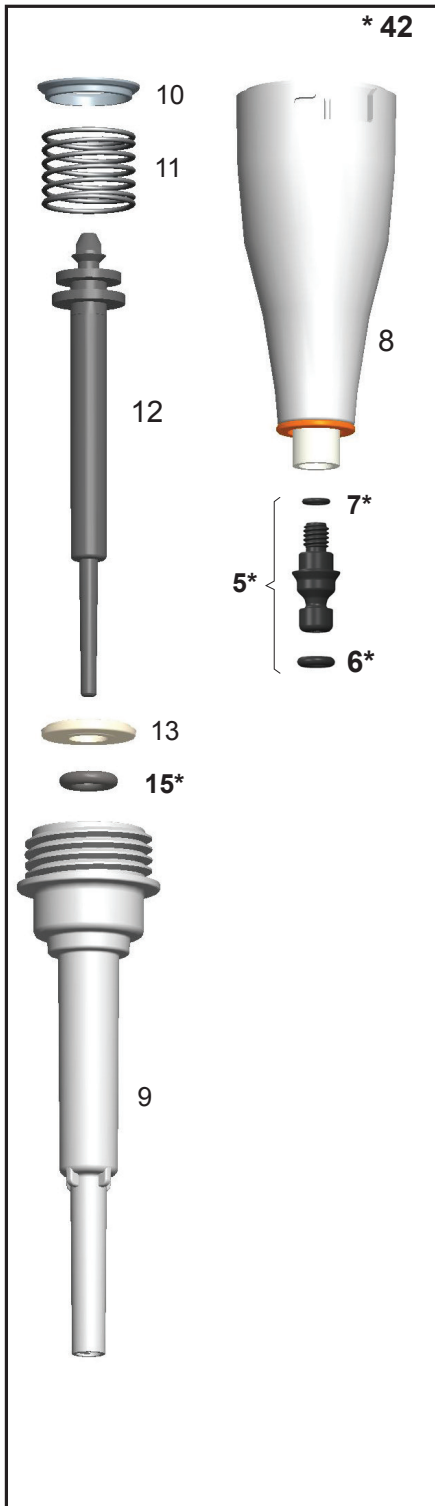

15–1250 μ l

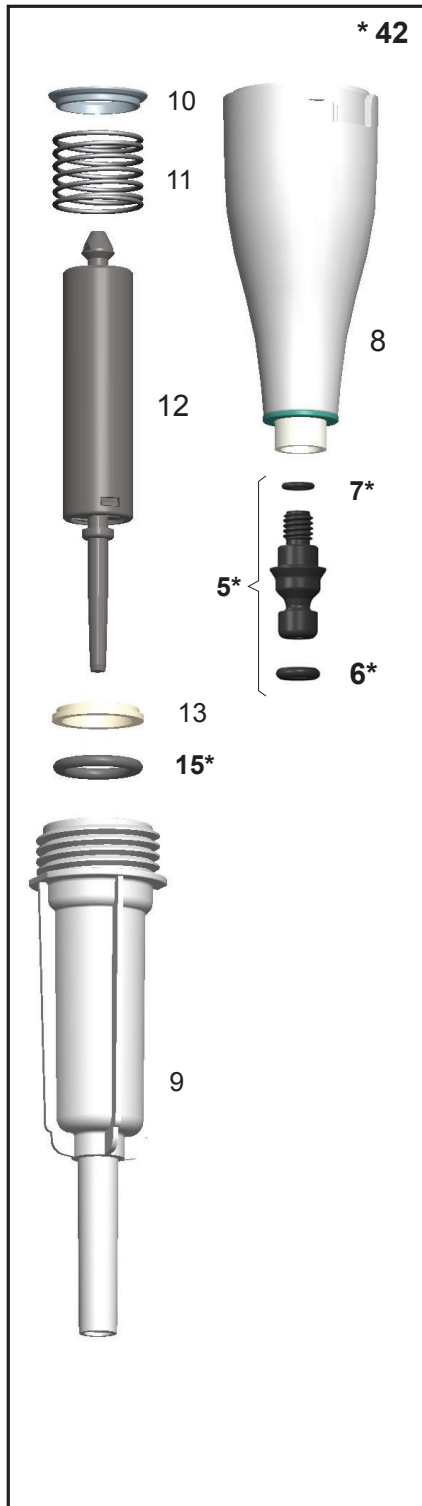

10–300 μ l

- 5. 2216160 4 pcs
- 6. 2214930 3 pcs
- 7. 1033430
- 15. 1033180
- 42. 2215580N

15–1250 μ l

- 5. 2216190 4 pcs
- 6. 2215540 3 pcs
- 7. 1033430
- 15. 1033420
- 42. 2215570N

Accessories

1062800
SCP Service tool A

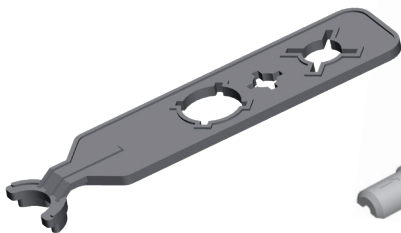

1062500
SCP Service tool B

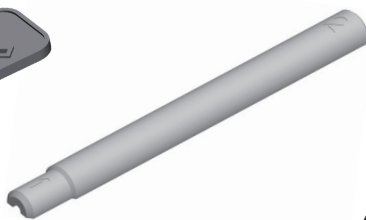

0300070
Tip fitting tool C



2215870
Tip fitting tool D

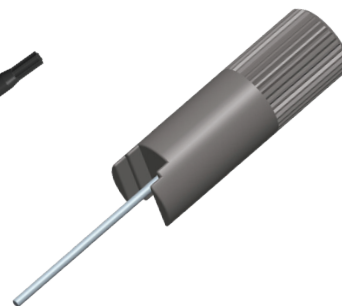

12905600 E1-ClipTip Charger + universal adapter set for direct charging of pipette (also spare part for 1-position charging stand. NOT compatible with multi charging stand)



9420500 E1-ClipTip 1-position Charging Stand System (contains transformer and stand)

9420510 E1-ClipTip Multi Charging Stand System for three pipettes (contains transformer and stand)

2215640 E1-ClipTip Lithium-ion Battery

3300200 Bag of grease 1g

3300210 Tube of grease 45g Klüberalfa

Appendix 5. ClipTip System Compatibility Chart

Order No.	Description	ClipTip						
		ClipTip 12.5 Ext*	ClipTip 20	ClipTip 50	ClipTip 200	ClipTip 300	ClipTip 300 Ext*	ClipTip 1000
F1-ClipTip Manual Pipettes								
	Single channels							
4641310N	F1-ClipTip 0.1-2µl	•						
4641320N	F1-ClipTip 1-10µl	•						
4641180N	F1-ClipTip 2-20µl		•					
4641190N	F1-ClipTip 5-50µl			•				
4641200N	F1-ClipTip 10-100µl				•			
4641210N	F1-ClipTip 20-200µl				•			
4641220N	F1-ClipTip 30-300µl					•	•	
4641230N	F1-ClipTip 100-1000µl							•
4651280N	F1-ClipTip 10µl Fixed	•						
4651200N	F1-ClipTip 20µl Fixed		•					
4651210N	F1-ClipTip 25µl Fixed			•				
4651220N	F1-ClipTip 50µl Fixed			•				
4651230N	F1-ClipTip 100µl Fixed				•			
4651240N	F1-ClipTip 200µl Fixed				•			
4651250N	F1-ClipTip 250µl Fixed					•	•	
4651260N	F1-ClipTip 500µl Fixed							•
4651270N	F1-ClipTip 1000µl Fixed							•
	Multichannels							
4661210N	F1-ClipTip 8-ch 1-10µl	•						
4661120N	F1-ClipTip 8-ch 5-50µl			•				
4661130N	F1-ClipTip 8-ch 10-100µl				•			
4661140N	F1-ClipTip 8-ch 30-300µl					•	•	
4661220N	F1-ClipTip 12-ch 1-10µl	•						
4661160N	F1-ClipTip 12-ch 5-50µl			•				
4661170N	F1-ClipTip 12-ch 10-100µl				•			
4661180N	F1-ClipTip 12-ch 30-300µl					•	•	

* Performance specifications with extended length tips differ from the specifications of the standard tips. Extended length tips will fulfill the ISO8655 specifications.

Order No.	Description	ClipTip												
		ClipTip 12.5	ClipTip 12.5 Ext*	ClipTip 20	ClipTip 50	ClipTip 200	ClipTip 300	ClipTip 300 Ext*	ClipTip 1000	ClipTip 1250	ClipTip 12.5 384	ClipTip 12.5 384 Ext*	ClipTip 30 384	ClipTip 125 384
E1-ClipTip Electronic Pipettes														
Single channels														
4670000 4670000BT	E1-ClipTip 0.5-12.5 µl	•	•											
4670020 4670020BT	E1-ClipTip 2-125 µl					•								
4670030 4670030BT	E1-ClipTip 10-300 µl						•	•						
4670040 4670040BT	E1-ClipTip 15-1250 µl									•				
Multichannels														
4671000 4671000BT	E1-ClipTip 8-ch 0.5-12.5 µl	•	•											
4671040 4671040BT	E1-ClipTip 8-ch 2-125 µl					•								
4671070 4671070BT	E1-ClipTip 8-ch 10-300 µl						•	•						
4671100 4671100BT	E1-ClipTip 8-ch 15-1250 µl									•				
4671010 4671010BT	E1-ClipTip 12-ch 0.5-12.5 µl	•	•											
4671050 4671050BT	E1-ClipTip 12-ch 2-125 µl					•								
4671080 4671080BT	E1-ClipTip 12-ch 10-300 µl						•	•						
4671090 4671090BT	E1-ClipTip 12-ch 30-850 µl								•					
4671020 4671020BT	E1-ClipTip 16-ch 0.5-12.5 µl										•	•		
4671030 4671030BT	E1-ClipTip 16-ch 1-30 µl												•	
4671060 4671060BT	E1-ClipTip 16-ch 2-125 µl													•
Adjustable Tip Spacing Equalizer Multichannels														
4672090 4672090BT	E1-ClipTip Equalizer 6-ch 15-1250 µl									•				
4672050 4672050BT	E1-ClipTip Equalizer 8-ch 2-125 µl					•								
4672080 4672080BT	E1-ClipTip Equalizer 8-ch 10-300 µl						•	•						
4672100 4672100BT	E1-ClipTip Equalizer 8-ch 15-1250 µl									•				
4672010 4672010BT	E1-ClipTip Equalizer 384 8-ch 0.5-12.5 µl										•	•		
4672030 4672030BT	E1-ClipTip Equalizer 384 8-ch 1-30 µl												•	
4672060 4672060BT	E1-ClipTip Equalizer 384 8-ch 2-125 µl													•
4672020 4672020BT	E1-ClipTip Equalizer 384 12-ch 0.5-12.5 µl										•	•		
4672040 4672040BT	E1-ClipTip Equalizer 384 12-ch 1-30 µl												•	
4672070 4672070BT	E1-ClipTip Equalizer 384 12-ch 2-125 µl													•

* Performance specifications with extended length tips differ from the specifications of the standard tips. Extended length tips will fulfil the ISO8655 specifications.

Appendix 6. ClipTip Ordering Information

ClipTip Racked (non-sterile and sterile)				
Order number	Description	Volume range	Color Coding	Qty
94410040	ClipTip 12.5	0.5-12.5 µl	Pink	10 x 96/rack
94410043	ClipTip 12.5, sterile	0.5-12.5 µl	Pink	10 x 96/rack
94410060	ClipTip 12.5 Ext	0.5-12.5 µl	Pink	10 x 96/rack
94410063	ClipTip 12.5 Ext, sterile	0.5-12.5 µl	Pink	10 x 96/rack
94410210	ClipTip 20	1-20 µl	Pink	10 x 96/rack
94410213	ClipTip 20, sterile	1-20 µl	Pink	10 x 96/rack
94410250	ClipTip 50	5-50 µl	Violet	10 x 96/rack
94410253	ClipTip 50, sterile	5-50 µl	Violet	10 x 96/rack
94410310	ClipTip 200	2-200 µl	Yellow	10 x 96/rack
94410313	ClipTip 200, sterile	2-200 µl	Yellow	10 x 96/rack
94410510	ClipTip 300	10-300 µl	Orange	10 x 96/rack
94410513	ClipTip 300, sterile	10-300 µl	Orange	10 x 96/rack
94410610	ClipTip 300 Ext	10-300 µl	Orange	10 x 96/rack
94410613	ClipTip 300 Ext, sterile	10-300 µl	Orange	10 x 96/rack
94410710	ClipTip 1000	30-1000 µl	Blue	8 x 96/rack
94410713	ClipTip 1000, sterile	30-1000 µl	Blue	8 x 96/rack
94410810	ClipTip 1250	15-1250 µl	Turquoise	8 x 96/rack
94410813	ClipTip 1250	15-1250 µl	Turquoise	8 x 96/rack
ClipTip 384 tip				
94410050	ClipTip 384 12.5	0.5-12.5 µl	Pink	10 x 384/rack
94410053	ClipTip 384 12.5, sterile	0.5-12.5 µl	Pink	10 x 384/rack
94410070	ClipTip 384 12.5 Ext	0.5-12.5 µl	Pink	10 x 384/rack
94410073	ClipTip 384 12.5 Ext, sterile	0.5-12.5 µl	Pink	10 x 384/rack
94410100	ClipTip 384 30	1-30 µl	Violet	10 x 384/rack
94410103	ClipTip 384 30, sterile	1-30 µl	Violet	10 x 384/rack
94410150	ClipTip 384 125	2-125 µl	Yellow	10 x 384/rack
94410153	ClipTip 384 125, sterile	2-125 µl	Yellow	10 x 384/rack
ClipTip Reloads (non-sterile and sterile)				
Order number	Description	Volume range	Color Coding	Qty
94410217	ClipTip 20 Reload Tower	1-20 µl	Pink	10 x 96/insert
94410218	ClipTip 20 Reload Tower, sterile	1-20 µl	Pink	10 x 96/insert
94410257	ClipTip 50 Reload Tower	5-50 µl	Violet	10 x 96/insert
94410258	ClipTip 50 Reload Tower, sterile	5-50 µl	Violet	10 x 96/insert
94410317	ClipTip 200 Reload Tower	2-200 µl	Yellow	10 x 96/insert
94410318	ClipTip 200 Reload Tower, sterile	2-200 µl	Yellow	10 x 96/insert
94410517	ClipTip 300 Reload Tower	10-300 µl	Orange	10 x 96/insert
94410518	ClipTip 300 Reload Tower, sterile	10-300 µl	Orange	10 x 96/insert
94410617	ClipTip 300 Ext Reload Tower	10-300 µl	Orange	10 x 96/insert
94410717	ClipTip 1000 Reload Tower	30-1000 µl	Blue	8 x 96/insert
94410718	ClipTip 1000 Reload Tower, sterile	30-1000 µl	Blue	8 x 96/insert
94410817	ClipTip 1250 Reload Insert	15-1250 µl	Turquoise	8 x 96/insert
94410818	ClipTip 1250 Reload Insert, sterile	15-1250 µl	Turquoise	8 x 96/insert

ClipTip Filter tips				
Order number	Description	Volume range	Color Coding	Qty
94420043	ClipTip Filter 12.5, sterile	0.5-12.5 µl	Pink	10 x 96/rack
94420063	ClipTip Filter 12.5 Ext, sterile	0.5-12.5 µl	Pink	10 x 96/rack
94420213	ClipTip Filter 20, sterile	1-20 µl	Pink	10 x 96/rack
94420253	ClipTip Filter 50, sterile	5-50 µl	Violet	10 x 96/rack
94420313	ClipTip Filter 200, sterile	2-200 µl	Yellow	10 x 96/rack
94420513	ClipTip Filter 300, sterile	10-300 µl	Orange	10 x 96/rack
94420613	ClipTip Filter 300 Ext, sterile	10-300 µl	Orange	8 x 96/rack
94420713	ClipTip Filter 1000, sterile	30-1000 µl	Blue	8 x 96/rack
94420813	ClipTip Filter 1250, sterile	15-1250 µl	Turquoise	8 x 96/rack
384 ClipTip Tips				
94420053	ClipTip Filter 384 12.5, sterile	0.5-12.5 µl	Pink	10 x 384/rack
94420073	ClipTip Filter 384 12.5 Ext, sterile	0.5-12.5 µl	Pink	10 x 384/rack
94420103	ClipTip Filter 384 30, sterile	1-30 µl	Violet	10 x 384/rack
94420153	ClipTip Filter 384 125, sterile	2-125 µl	Yellow	10 x 384/rack
ClipTip Filter Reload Inserts				
Order number	Description	Volume range	Color Coding	Qty
94420218	ClipTip 20 Filter Reload, sterile	1-20 µl	Pink	10 x 96/insert
94420258	ClipTip 50 Filter Reload, sterile	5-50 µl	Violet	10 x 96/insert
94420318	ClipTip 200 Filter Reload, sterile	2-200 µl	Yellow	10 x 96/insert
94420518	ClipTip 300 Filter Reload, sterile	10-300 µl	Orange	10 x 96/insert
94420718	ClipTip 1000 Filter Reload, sterile	30-1000 µl	Blue	8 x 96/insert
94420818	ClipTip 1250 Filter Reload, sterile	15-1250 µl	Turquoise	8 x 96/insert
ClipTip Empty Racks				
94410219	ClipTip Empty Rack Small	ClipTip 20 µl and 50 µl		10 x 96/rack, no tips/inserts
94410519	ClipTip Empty Rack Medium	ClipTip 200 µl and 300 µl		10 x 96/rack, no tips/inserts
94410619	ClipTip 300 Ext Empty Rack	ClipTip 300 Ext		8 x 96/rack, no tips/inserts
94410819	ClipTip Empty Rack Large	ClipTip 1000 and 1250 µl		8 x 96/rack, no tips/inserts

All ClipTip tips are certified to be free of RNase, DNase, ATP, and endotoxins.

This product is covered by patents issued in the US.

For patent coverage, see <http://www.thermofisher.com/pipetteip>

info.pipettes@thermofisher.com

www.thermofisher.com/cliptip

www.thermofisher.com

thermofisher.com

© 2020 Thermo Fisher Scientific Inc. All rights reserved. All trademarks are the property of Thermo Fisher Scientific Inc. and its subsidiaries. Specifications, terms and pricing are subject to change. Not all products are available in all countries. Please consult your local sales representative for details.

Thermo Fisher Scientific Oy

Ratastie 2

01620 Vantaa

Finland

1508890-13-EN

thermo
scientific