



Thermo Scientific Orion 7070iX Total Residual Oxidant Analyzer

Installation and Operation

UM-272700-A01 • Revision A • April 2019

IMPORTANT Read this instruction manual. Failure to follow the instructions in this manual can result in damage to the unit, injury to operating personnel and poor equipment performance.

CAUTION All internal adjustments and maintenance must be performed by qualified service personnel.

Material in this manual is for informational purposes only. The contents and the product it describes are subject to change without notice. Thermo Fisher Scientific makes no representations or warranties with respect to this manual. In no event shall Thermo Fisher Scientific be held liable for any damages, direct or incidental, arising from or related to the use of this manual.

© 2019 Thermo Fisher Scientific Inc. All rights reserved.

Contents

Preface	1
Legal Information.....	1
Warranty Information.....	1
Warrant on Shipments / Returns / Adjustments.....	2
General Information.....	3
Safety Precautions	3
Symbols used in the Manuals.....	3
Intended Use.....	4
Principles of Operations	4
Sample Requirements	5
System Description	5
Block Diagram Electrical / Fluidics	6
.....	6
Analyzer Installation.....	8
Site Preparation	8
Unpacking the Instrument	8
Mounting and Plumbing Instructions	9
Analyzer Description	14
Startup and Operation	16
Placing the TRO Analyzer into Service	16
Menu Navigation.....	17
Measurement.....	18
Diagnostics	18
Setup.....	19
Service.....	21

Calibration and Validation.....	22
Calibration Standards.....	22
Calibration Procedure for 2-point Calibration and 1-point Calibration.....	23
Measure a Grab Sample or Performing a Validation..	26
Collecting a Grab Sample from the TRO Analyzer.....	27
Maintenance and Troubleshooting	28
Extended Shutdown.....	28
Complete Removal.....	28
Sensor	28
Reagent	28
Cleaning	28
Decontamination and Disposal of Reagent	28
Troubleshooting	29
Maintenance Schedule.....	30
Specifications	33
Customer Service	35
Notice of Compliance.....	35
Consumables.....	35
Assistance	35

Preface

These operating instructions are protected by copyright. Rights resulting thereof, particularly reprint, photo-mechanical or digital post-processing or reproduction, even in parts are only allowed with the written consent of Thermo Fisher Scientific. This regulation does not apply to reproductions for in-plant use. The contents of this operating instructions manual may change at any time and without any prior notice. In case of conflicting translations into foreign languages the English-language version of these operating instructions shall be binding.

Read through the information given in these operating instructions on installing and operating the system before you begin installation and use of your "Total Residual Oxidant Analyzer". This is of particular importance, as we, the manufacturer, do not assume any liability for damage due to incorrect operation or use of the system other than the intended use.

Thermo Fisher Scientific Inc. provides this document to its customers with a product purchase to use in the product operation. This document is copyright protected. Any reproduction of the whole or any part of this document is strictly prohibited, except with the written authorization of Thermo Fisher Scientific Inc. The contents of this document are subject to change without notice. All technical information in this document is for reference purposes only. System configurations and specifications in this document supersede all previous information received by the purchaser.

Thermo Fisher Scientific Inc. makes no representations that this document is complete, accurate or error-free and assumes no responsibility and will not be liable for any errors, omissions, damage or loss that might result from any use of this document, even if the information in the document is followed properly.

This document is not part of any sales contract between Thermo Fisher Scientific Inc. and a purchaser. This document shall not govern or modify any Terms and Conditions of Sale, which Terms and Conditions of Sale shall govern all conflicting information between the two documents.

Legal Information

Note: Specifications, terms and pricing are subject to change. Not all products are available in all countries. Consult your local sales representative for details.

Warranty Information

Thermo Fisher Scientific warrants to the original purchaser of any new merchandise that all items will be free of defects in material and workmanship for the periods set forth below, when used under specified and normal operating conditions, in accordance with the operating limitation and procedures given in the instruction manuals, and when not subjected to accident, alteration, abuse or misuse of Thermo Fisher Scientific's products in unspecified applications, for unauthorized procedures, or with third-party products may void the warranty.

Thermo Scientific's instruments are warranted as follows:

All parts in contact with the sample for a period of ninety (90) days from the date of installation. Sample must be chemically compatible with parts ordered with the product. If parts are not compatible or if a question exists regarding compatibility, notify the factory before placing the product in service to maintain the warranty.

Parts not in contact with sample for a period of one (1) year from the date of shipment.

Tubing for a period of thirty (30) days under normal operation.

THE WARRANTIES DESCRIBED ARE EXCLUSIVE AND IN LIEU OF ALL OTHER WARRANTIES WHETHER STATUTORY, EXPRESSED OR IMPLIED. ALL OTHER WARRANTIES OF MERCHANTABILITY AND FITNESS FOR A PARTICULAR PURPOSE, AND ALL OTHER WARRANTIES ARISING FROM COURSE OF DEALING OR USAGE OF TRADE, EXCEPT TITLE, ARE HEREBY OVERRIDDEN AND EXCLUDED. NO LIABILITY SHALL ATTACH TO THERMO SCIENTIFIC EITHER IN CONTRACT OR IN TORT, FOR ANY PERSONAL INJURY, DEATH, DAMAGE TO PROPERTY, LOSS OF PROFITS, DAMAGES, COSTS, CHARGES, LIABILITIES OR EXPENSES, WHETHER DIRECT OR INDIRECT, CONSEQUENTIAL OR OTHERWISE, WHICH ARISE OUT OF OR IN CONJUNCTION WITH THE SALE OR USE OF THIS PRODUCT.

The sole and exclusive remedy of the customer is the return of defective components or sub-assemblies to Thermo Fisher Scientific for repair or replacement or, at Thermo Fisher Scientific's option, refund of the purchase price. For the most current warranty information, visit www.thermofisher.com/water.

Warrant on Shipments / Returns / Adjustments

A warranty claim must be made promptly and must be received during the applicable warranty period by Thermo Fisher Scientific or your authorized Thermo Fisher Scientific distributor. If it becomes necessary to return a product for repair and / or adjustment, prior authorization from Thermo Fisher Scientific or your Thermo Fisher Scientific- authorized distributor must be obtained. Instructions as to how and where these products should be shipped will be provided by Thermo Fisher Scientific or your Thermo Fisher Scientific-authorized distributor.

Any product or component returned for examination and / or warranty repair shall be sent to Thermo Fisher Scientific in MA, or any of their authorized representatives. All items must be returned at the customer's cost (freight prepaid), quoting a return authorization number that is available from the Service department. All products or components repaired or replaced under warranty will be returned to the customer at Thermo Fisher Scientific's cost.

In all cases, Thermo Fisher Scientific or your Thermo Fisher Scientific-authorized distributor has sole responsibility for determining the cause and nature of failure, and Thermo Fisher Scientific's or the distributor's determination with regard thereto shall be final. All parts that are replaced under warranty will become the property of Thermo Fisher Scientific.

General Information

The Thermo Scientific™ Orion™ 7070iX Total Residual Oxidant Analyzer is an iodometric measurement system designed in demand measurement of total residual oxidants in process water in the range from 0.001 to 15 ppm. The instrument responds to changes in oxidant concentration within 30 seconds and detects residual oxidants in real time, providing immediate feedback for water control mechanisms.

Safety Precautions

Thermo Fisher Scientific does not accept any liability for damage that may arise if information in this manual is not followed. Therefore, the operating instructions and specifications must be read and understood by all personnel involved in installation and operation of this equipment.

Thermo Fisher Scientific will not be liable for direct, indirect, special, incidental or consequential damages resulting from any defect or omission in this manual. Thermo Fisher Scientific reserves the right to make changes in this manual and the products it describes at any time, without notice or obligation. Revised editions are found on the Thermo Fisher Scientific website.

Intended operators should read and understand the entire manual before operating this system. Special attention should be given to all safety and caution notes contained in this manual. Failure to do so could result in serious injury to the operator or damage to the equipment.

The Thermo Scientific Orion 7070iX Total Residual Oxidant Analyzer has been designed with careful attention to safety. It complies with formal safety design rules established by international regulatory agencies. Observe all safety warnings marked on the instrument.

These warnings identify areas of potential hazard, which could result in personal injury or loss of life.

To ensure that the protection provided by this equipment is not impaired, do not use or install this equipment in any manner other than that which is specified in this manual.

- Do not use this product for any purpose other than described in this manual.
- Disconnect power before servicing and prior to making any terminal connections within the analyzer enclosure.
- Do not operate with the electronics enclosure door open.

Safety Information

Note: Thermo Fisher Scientific is not responsible for any damages due to misapplication or misuse of this product including, without limitation, direct, incidental and consequential damages, and disclaims such damages to the full extent permitted under applicable law. You are solely responsible to identify critical application risks and install appropriate mechanisms to protect processes during a possible equipment malfunction.

Symbols used in the Manuals

Read all labels and tags attached to the instrument. Personal injury or damage to the instrument could occur if not observed. A symbol on the instrument is referenced in the manual with a precautionary statement.



DANGER: Indicates a potentially or imminently hazardous situation which, if not avoided, will result in death or serious injury.



CAUTION: This symbol, in the context of a CAUTION, indicates a potentially hazardous situation which if not avoided could result in minor to moderate injury or damage to the equipment.



Hot: This symbol indicates that the marked area can be hot and should not be touched without care.



Earth (Ground): This symbol, when noted on the product, identifies the location of the connection for Protective Earth (ground).



Voltage Warning: The Orion 7070iX Total Residual Oxidant Analyzer utilizes hazardous voltages. The power source must be disconnected before accessing the internal components in the Display monitor or performing any maintenance on this system. A mains power disconnect must be provided in the area where Orion 7070iX Total Residual Oxidant Analyzer is located.



Personal Protective Equipment Warning: Proper safety equipment must be worn at all times when servicing the instrument including proper eye protection and gloves when working with the reagent and flow cell section.

NOTICE Indicates a situation which, if not avoided, may cause damage to the instrument or instruction for special use.

NOTE Indicates important information that requires special attention.

Intended Use

The Thermo Scientific Orion™ 7070iX Total Residual Oxidant Analyzer is an Iodometric Measurement System designed for on-demand measurement of total residual oxidants in process water, cooling water or waste water in the range from 0.001 to 15 ppm. This analyzer model is intended to use for water analysis only.

Principles of Operations

The Orion 7070iX Total Residual Oxidant (TRO) Analyzer is an on-demand instrument that provides a TRO measurement. The analyzer initiates the analysis mode when sample flow is present. When no sample flow is present, it does not consume reagent and can support a significant reduction in the analyzer maintenance. The maintenance and calibration cycle required for the Orion 7070iX Total Residual Oxidant Analyzer is 80 Total hours of active operation.

The chemistry employed in the analyzer is the EPA approved iodometric method for total residual chlorine, in which iodide together with an acid reagent is added to the sample to react with and convert all chlorine present to iodine. The formed iodine is sensed directly by the combination of solid-state electrode. In the Orion 7070iX Total Residual Oxidant Analyzer, a portion of the main sample water stream is drawn and introduced to the flow channel where the chemical reagent is added to convert all TRO to iodine. The reacted solution is measured by the TRO sensor in the flow cell.

A general nonspecific description of the iodometric reaction for total oxidants is given as:

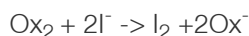

where:

Ox_2 is total oxidant, such as total chlorine or a combination of oxidant species.

I^- is iodide

I_2 is iodine

The concentration of iodine is equal to the concentration of oxidant before reaction.

The TRO Sensor is a potentiometric combination sensor containing a platinum (redox) sensing electrode and an iodide reference electrode. The combination voltage (potential, E) generated between the sense and reference electrodes is proportional to the iodine produced in the sample after reagent addition. The higher the TRO concentration in the sample, the more iodine is produced and the higher voltage is generated following the Nernst Equation:

$$E = E_0 + S \log [\text{I}_2] = E_0 + S \log [\text{Ox}_2]$$

where:

E_0 is the cell constant in mV at a fixed temperature

S is the sensor slope (approximately 29.6 mV / decade at 25 °C by theory)

$[\text{I}_2]$ is the iodine concentration (ppm)

$[\text{Ox}_2]$ is the total residual oxidant concentration (ppm)

After suitable calibration, the measured voltage E is converted by the analyzer to read directly as TRO in ppm. The analyzer detects TRO using an electrochemical process, which is affected by the temperature of the sample. The sensor response in the Orion 7070iX Total Residual Oxidant Analyzer is dependent upon the sample temperature. In the Orion 7070iX Total Residual Oxidant Analyzer, sample temperature is measured continuously in the flow cell and the calculated TRO is adjusted to reflect the response which would result at the calibration temperature. This software adjustment ensures optimum accuracy over the sample temperature range.

Orion 7070iX Total Residual Oxidant Analyzer uses software to tightly control the flow of reagent resulting in elimination of excess reagent which could cause error due to secondary species formation.

Location



The Orion 7070iX Total Residual Oxidant Analyzer is not suitable for hazardous location as delivered. Indoor locations only.

Temperature:	41 - 113 °F / 5 - 45 °C
Relative Humidity:	20% to 85%
Altitude:	0 to 2000 m
Pollution degree:	2
Over-voltage:	Category 2
Mains Supply Nominal:	100 - 240 VAC 50 / 60 Hz
Mains Supply Fluctuations:	±10% of nominal

Sample Requirements

Sample Inlet Connection:	The instrument is supplied with a 1/4 - inch OD plastic tube with quick connect fitting for sample water inlet
Flow Rate	minimum of 40 mL / minute
Sample Pressure:	5 to 50 psi
Temperature:	41 to 113 °F / 5 to 45 °C
Alkalinity:	Up to 500 ppm as CaCO ₃
Max Turbidity:	500 NTUs
Max TSS:	1000 PPM
Max particle size:	130 microns

Refer to **Specifications** for details.

System Description

The Orion 7070iX Total Residual Oxidant Analyzer can be used on either the discharge side or the generation side of a Water Treatment System for monitoring the TRO concentration in the sample stream. The location of the analyzer is a critical factor in ensuring fast response time and care should be taken to install the analyzer as close as possible to the source of the sample.

Analyzer Connections

The water connections to the analyzer include the following:

- Sample water input – Flow from source to analyzer.
- Fast-loop sample output – Sample water return.
- Measured water output – Measurement cell discharge composed of combined sample and reagent.

Additional connections are for the following:

- AC power.
- Remote operation (Electrically Isolated 2 wire Digital Signal input. + input signal range is + 3 VDC to + 5.5 VDC, - side signal is 0 V).
- Analog data communications (two 4-20 mA).

Block Diagram Electrical / Fluidics

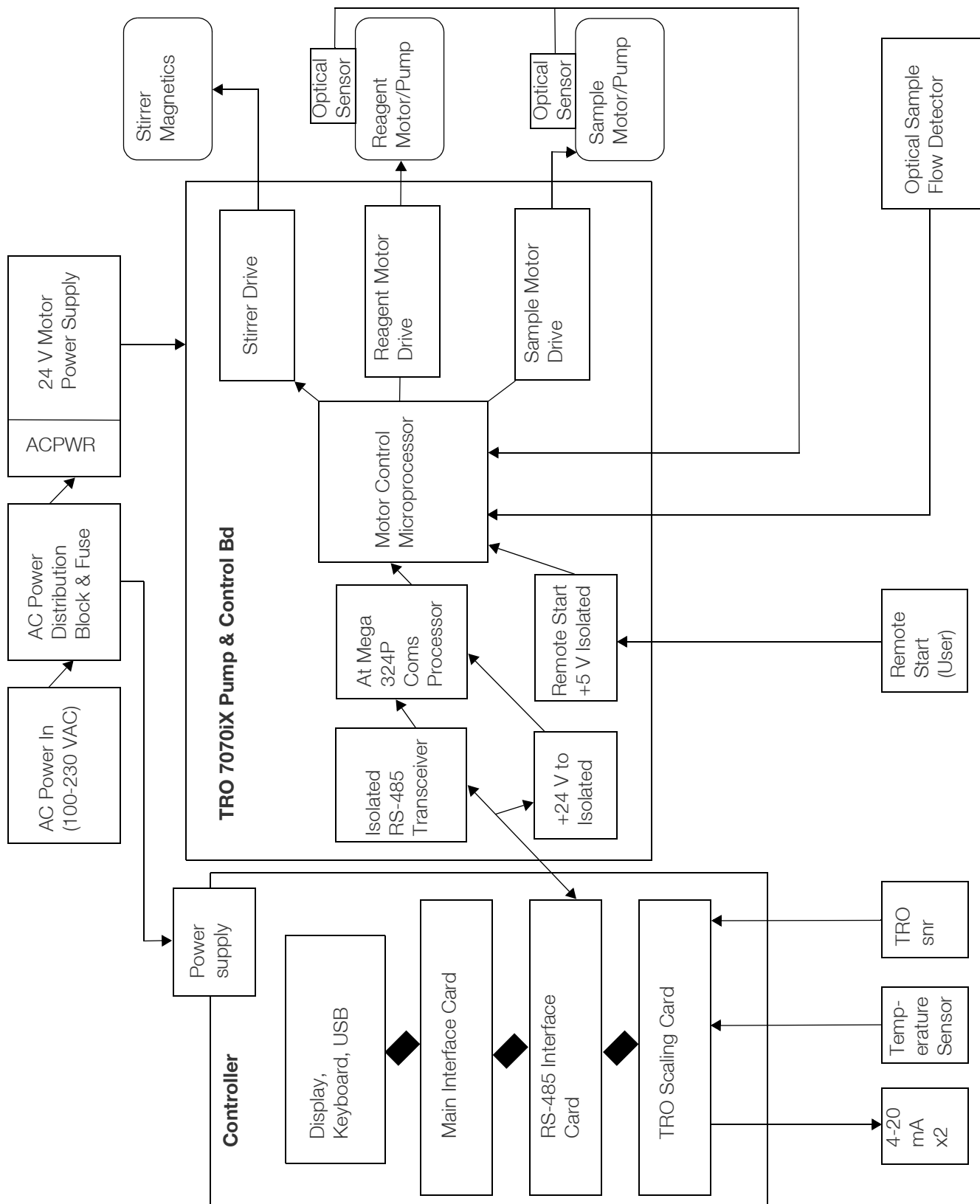

Figure 1. Block Diagram Electrical

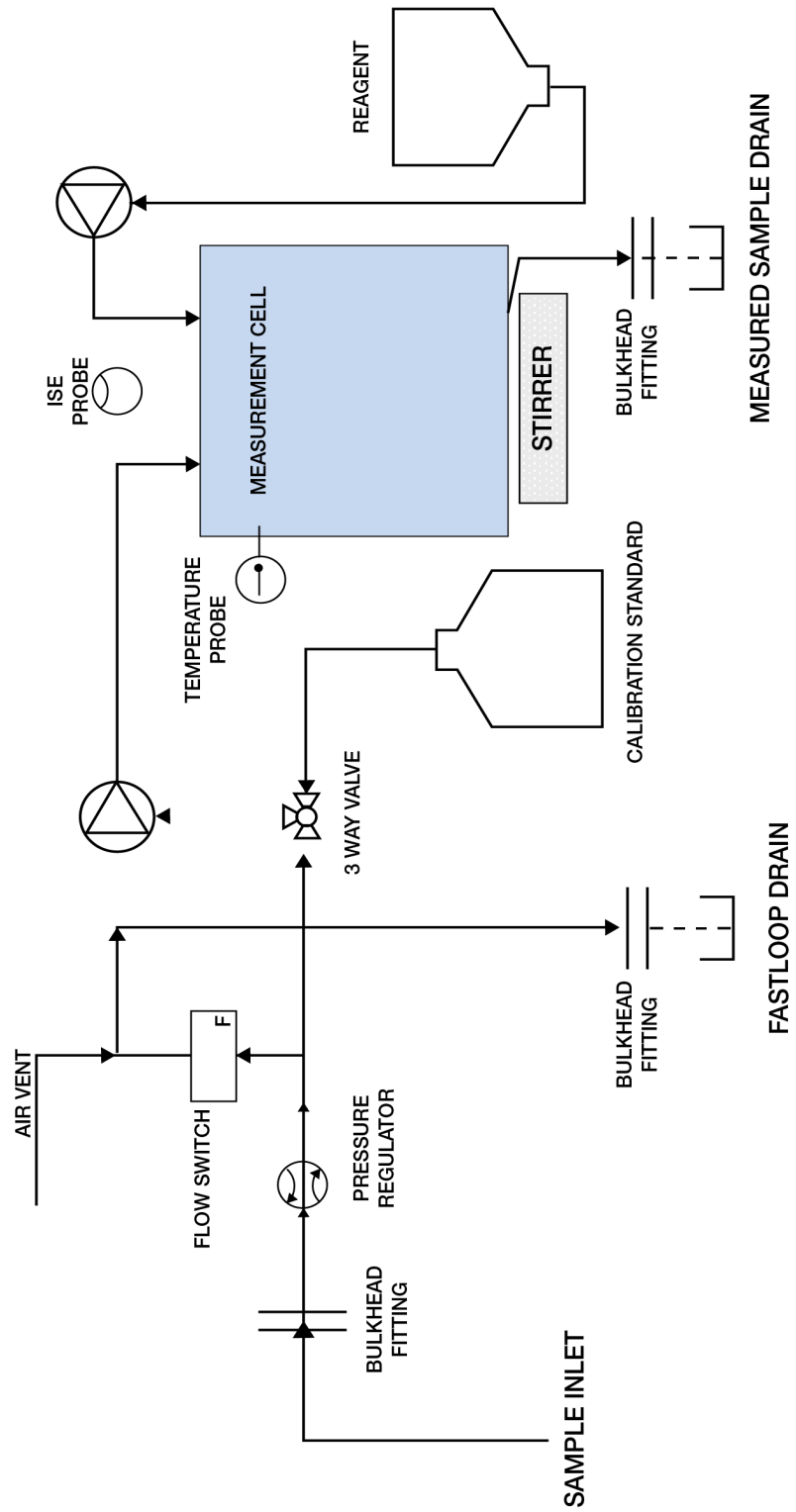

Figure 2. Process Flow Diagram

Analyzer Installation



WARNING: The instructions provided in this user guide are recommendations from the manufacturer to ensure safe and correct operation of the analyzer. If the analyzer is not used as recommended by the manufacturer this can lead to incorrect operation or injury.



CAUTION: The equipment exceeding 40 lbs. should be lifted with the help of two persons or follow any heavy lifting policies your employer has put in place.

Site Preparation

General Instructions

Only qualified personnel should install the Orion 7070iX Total Residual Oxidant Analyzer as per the instructions provided in this manual.

- The products must be used as delivered without modifications.
- To ensure safe and robust mechanical mounting, it is recommended that lock nut or suitable safeguard adhesive be used in the mounting of the analyzer.
- For connections to power and data, it is recommended that suitable approaches such as conduit or liquid tight seal / glands be used for robust and durable waterproof seals.

Note: In all cases, appropriate torque tool should be used to assure proper seals.

Site Selection and Preparation

Thermo Fisher Scientific recommends that to ensure optimal analyzer performance, the selected site must meet the following criteria:

- Select a site for the analyzer that allows it to be permanently bolted with ample height for atmospheric drain operation. Be sure that there is ready access to the electronic controls, calibration port and electrodes.
- The analyzer location must permit connections to a sample line, two drain lines, and AC power supply and any connections for output devices.

- The analyzer should be mounted as close to the sampling point as possible. This ensures the fastest possible response to changing sample condition. Refer to the Appendix, Sample Conditions section.
- The Orion 7070iX TRO Analyzer should be installed in a well ventilated location with ambient temperature between 5 °C and 45 °C (41 °F to 113 °F); and relative humidity must not exceed 85% at 40 °C (104 °F). The area must be free from dust, corrosive gases, vibration and shocks; sheltered from direct sunlight, and shielded from dripping water.
- For proper flow cell operation, the analyzer must be installed straight and level upon its mounting location.
- Large enough wall or mount space to accommodate Orion 7070iX Total Residual Oxidant Analyzer.
- Area and structural support have good mechanical integrity for support of the analyzer weight and connection of electrical conduit and pipes.
- Maximum distance of 1000 ft for 4-20 mA data communication conduit to the to the main control system.
- AC power must have a circuit breaker/disconnecting device and on-off switch within arm's reach and be installed via a conduit according to local regulations.
- AC Power source must include a connection point to the earth ground - suitable for at least 10 AWG wire for the grounding bar marked with a GND symbol.

Required Tools

Mechanical Tools:

- #4 Phillips screw driver
- 3/4 - inch wrench for mount bolts and nut

Tools for electrical connection:

- 2 mm straight screwdriver for wiring terminal blocks, for AC and sensors.

Unpacking the Instrument

Thermo Scientific Orion analyzers are assembled, tested and packaged with great care.

Report any obvious damage of shipping container to carrier and hold for inspection. The carrier (not Thermo Fisher

Scientific) is responsible for any damage incurred during shipment.

Note: Please retain the shipping box for future transportation of analyzer if needed.

Note: The analyzer may be shipped with a protective cover on the plastic door. Carefully peel off this protection layer and discard it.



WARNING: Do not apply electrical power to visibly damaged components, as injury or further equipment damage may occur.

Note:



Figure 3. Unpacking the Instrument

1. Open the box. This box should contain the Orion 7070iX Total Residual Oxidant analyzer.
2. Remove top layer.
3. Remove the foam retainers by pulling out.
4. Remove analyzer from box.
5. Carefully remove any remaining foam attached to the analyzer.

Note: Do not lift or pull the analyzer by the fluids or the electronic components.

6. Carefully place the analyzer at a convenient location until proper installation can be completed.

Mounting and Plumbing Instructions



WARNING: Do not connect power prior to the mounting and plumbing of the analyzer.

Analyzer Mounting

The following **Figure 4** shows the dimensions and mounting points for the Orion 7070iX Total Residual Oxidant Analyzer. The TRO analyzer has a dry weigh of 45 lbs. (20.4 kg).

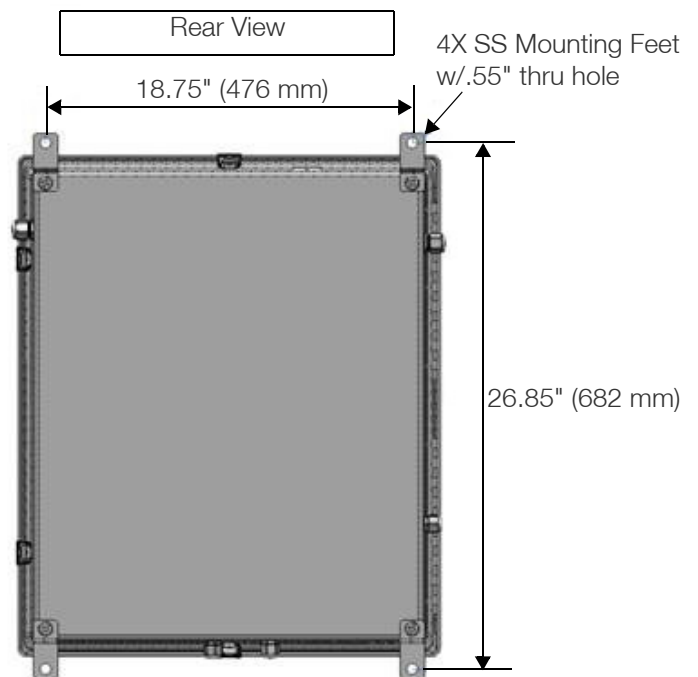

Figure 4. Analyzer Mounting

Connecting AC Mains Power to the Orion 7070iX TRO Analyzer

Wiring Requirements:



WARNING: The Requirements and Instructions described in this section must be carefully followed to insure safe connection and operation of the 7070iX TRO Analyzer.



The Orion 7070iX Total Residual Oxidant Analyzer is designed to be permanently wired to the AC Mains power.

An external, dedicated Power Switch or Circuit Breaker/ disconnecting device with an integrated Power Switch, must be located within reach of the TRO Analyzer. This is to facilitate safe removal of power for service and maintenance of the Analyzer or removal of power in case of an emergency.

The Analyzer operates over AC Mains Power range of 100 VAC to 240 VAC, 50/60 Hz nominal. Maximum allowable Mains Power fluctuations is +/- 10% and Maximum Current requirement is 0.4 A. Insure that the AC Mains power source meets these requirements before connecting the Analyzer to the Mains power source.

All wiring to the TRO Analyzer must be made in accordance with current National & Local electrical codes and safety regulations. Wiring is to be performed by a licensed Electrician.

A Class A GFCI (Ground Fault Circuit Interrupt) circuit breaker, with appropriate Voltage and Current rating is recommended where in accordance with local codes.

The power cable to the TRO Analyzer is supplied by the customer. A certified 3 conductor 14 AWG power cord with appropriate voltage, current and temperature rating is recommended. The power cable must be compliant with local code.

Use of a grounded conduit for the power cable is recommended.

Connecting Power to the Orion 7070iX TRO Analyzer



WARNING: Wiring is to be performed by a licensed Electrician



WARNING: Refer to **Figure 6** for details of the power wiring connections before Connecting Power to the Orion 7070iX TRO Analyzer.



WARNING: Insure that the AC Mains Power is **OFF**, prior to making any connections between the Mains power source and the Analyzer.

Remove the Electronics Enclosure cover (**Refer to Figure 8**). Locate and remove the AC Power Safety cover to access the AC Power Terminal block (**refer to Figure 6**). Do not disturb the factory installed wiring on the right side of the AC Power Terminal block.

Pass the Power cable through the outer and inner Liquid tight cable fitting located on the upper left side of the Analyzer enclosure. Strip approximately 3.5" of the outer jacket from the power cable end. Cut the inner wires so that the ground wire is 1.5" longer than the hot and neutral wires. Strip insulation on all three wire ends at 0.375".

Locate the AC Power Terminal block. (Mounted on the DIN Rail - Refer to **Figure 6** & **Figure 7**). Insert the Line/AC HOT wire into the terminal labeled L AC HOT. This is the terminal with the internal fuse. (The terminal may need to be opened by turning the terminal screw counter clockwise before inserting the wire into the terminal). Tighten the locking screw for this terminal and check that the wire is firmly connected to the terminal block.

Insert the Neutral wire into the terminal labeled N AC Neutral. Tighten the locking screw for this terminal and check that the wire is firmly connected to the terminal block.

Insert the Ground wire into the Ground lug terminal labeled G GROUND WIRE. Tighten the locking screw for this terminal and check that the wire is firmly connected to the ground terminal.

Insure that the wire loop on the ground wire is longer than the Neutral and Hot wire loops (**refer to Figure 6**).

Wire color reference chart:

Analyzer Terminal	North American Wire Color	European Wire Color
Line/AC HOT	Black	Brown
Neutral	White	Blue
Ground	Green	Green / Yellow stripe

Reinstall the AC safety cover. Tighten inner and outer Cable grip caps to TBD in/oz.

Reinstall the Electronics Enclosure cover.

Ensure that the Power cable is firmly held in place by the Liquid tight cable fittings.

Connecting Input and Output signal wiring to the Orion 7070iX TRO Analyzer

- Faceplate – Refer to **Figure 5**.



Figure 5. Faceplate

- Power supply – Refer to **Figure 6**.

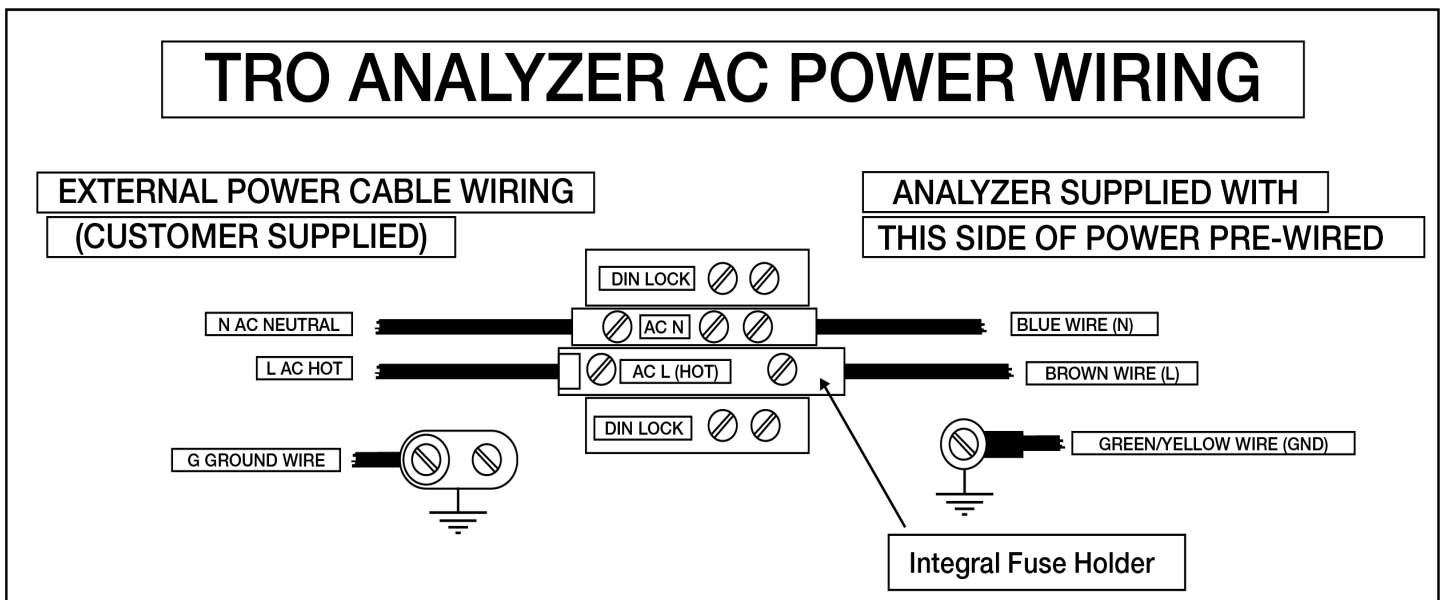

Figure 6. TRO Analyzer AC Power Wiring

Note: In case of replacement, use only 5x20 mm fuse type, and the fuse is not a customer serviceable item.

Terminal Block Interconnections

The following figure shows the terminal block connections.

The AC Line (HOT) terminal block contains a 5x20 mm fuse for circuit protection. Refer to the label next to the terminal block with the fuse type and rating.

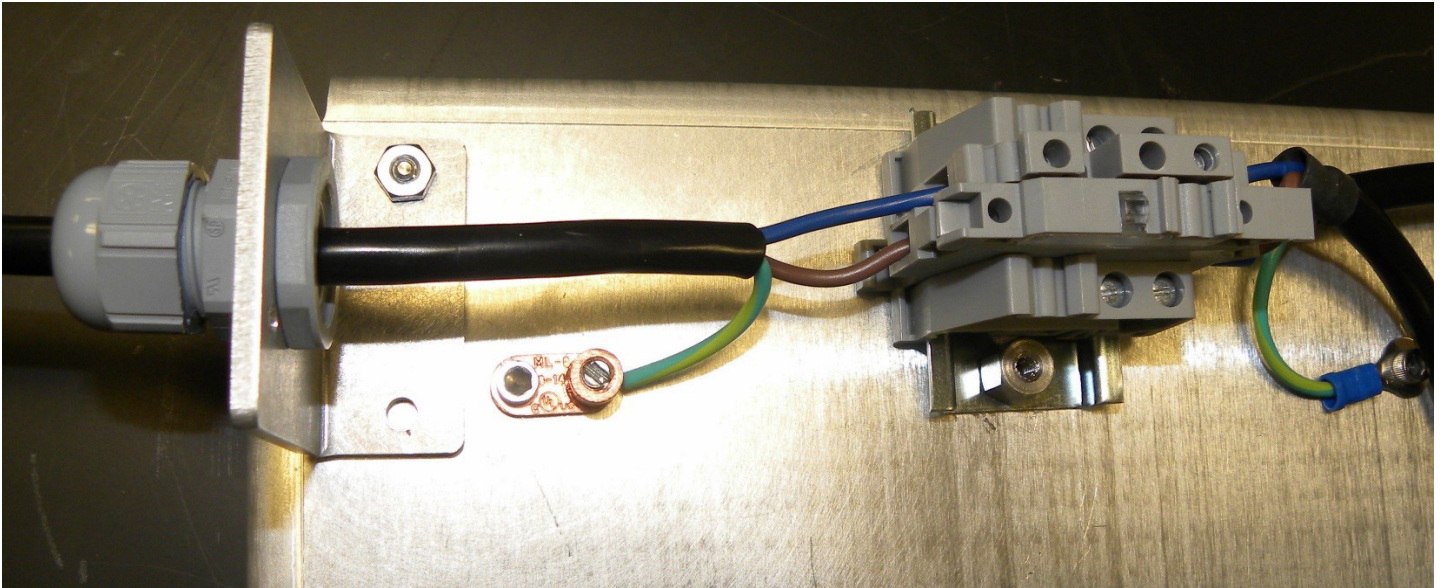

Figure 7. Terminal Block Interconnections

Wiring

Instrument power requirements are 100 to 240 VAC, 50/60 Hz nominal and the wiring of the instrument is the responsibility of the installer. However, Thermo Fisher Scientific recommends the following:

- All wiring must be made in accordance with current national, local electric codes and safety regulations.
- Due to a close proximity to water, it is strongly recommended to use separate power circuit with dedicated Class A GFCI (Ground Fault Circuit Interrupt) circuit breaker/disconnecting device, with appropriate voltage and current ratings.
- It is recommended to use shielded power cable, with 3 conductors 18 AWG minimum including ground conductor. The ground conductor wire free length should be longer than the AC L (hot) and AC Neutral wires.
- The Orion 7070iX Total Residual Oxidant Analyzer ground connection can be made redundant through double grounding, either by doubling wires or using mounting hardware to electrically attach the instrument to grounded substrate. In case of redundancy provided by mounting hardware, the primary grounding must be done with at least a 10 AWG dedicated wire conductor.
- Use of a grounded conduit for the power cable is recommended.













- For all wiring details of the instrument and sensors, see **Wiring Diagram**.



CAUTION: The analyzer is intended for use only with single-phase power. The analyzer is not equipped with a power switch, therefore a circuit breaking device is required such as a circuit breaker/disconnecting device. The circuit breaker must conform to local safety standards and codes. The circuit breaker must be fitted before the final installation, prior to connecting AC power to the Analyzer. The circuit breaker must be in close proximity to the analyzer and within reach of the user and must be marked clearly as the disconnected device for the analyzer. **ALL CONDUCTORS NEED TO HAVE MINIMUM INSULATION RATING OF 75 °C.**

Wiring Diagram

Table 1. Wiring Details

Label	Label Name	Function
	TRO Sense Clear	TRO Sense Clear Wire
	Shield	Not Connected
	Sol Gnd Red	Not Connected
	Reference Black	TRO Sensor Black Wire
	Blank	Not Connected
	TC black	Temperature Sensor-Black Wire
	TC red	Temperature Sensor-Red Wire
	Blank	Not Connected
	Blank	Not Connected
	mA Out 1	4/20 Output 1 user wiring
	Output Common	4/20 Output 1 and 2 ground user wiring
	mA Out 2	4/20 Output 2 user wiring



CAUTION: Observe all health and safety procedures for handling chemicals. Wash any spillage with distilled water. **EMPTY ALL REAGENTS BEFORE SHUTTING UNIT DOWN.** For more information refer section **Maintenance and Troubleshooting.**

Note:

1. Turn the reagent cap clockwise while holding bottle vertical and level.
 2. Inspect the tubes to be sure none have been pinched.
- Follow the steps to install the reagent:

1. Open the outlet of the cardboard box of the reagent package.
2. Place the reagent box onto the reagent shelf with the dispensing spout seated through the bottom hole on the shelf facing downwards. Secure the box by using the black strap.
3. Push down the gray/blue cap onto the dispensing spout of the reagent bag and turn to secure the attached cap.

Note: Take care to ensure there is no leaking by aligning the threads of the cap with bag threads. A click is felt when cap is locked in place.

4. Ensure the reagent is fully primed by running the Prime two times (initial instrument install only) to fill the volume of the transfer tube.
5. Inspect the reagent transfer tubing to be sure that it is filled with reagent. Gentle tapping can move air bubbles if they occur. It is important to the accuracy of reagent delivery that no air bubbles are present in the transfer tubing.
6. Installation is now complete.

Reagent Installation



WARNING: It is recommended to wear latex gloves and safety glasses whenever handling or changing reagents.



CAUTION: Handling chemical samples, standards and reagents can be dangerous. Review the necessary Material Safety Data Sheets and become familiar with all safety procedures before handling any chemicals.

Analyzer Description

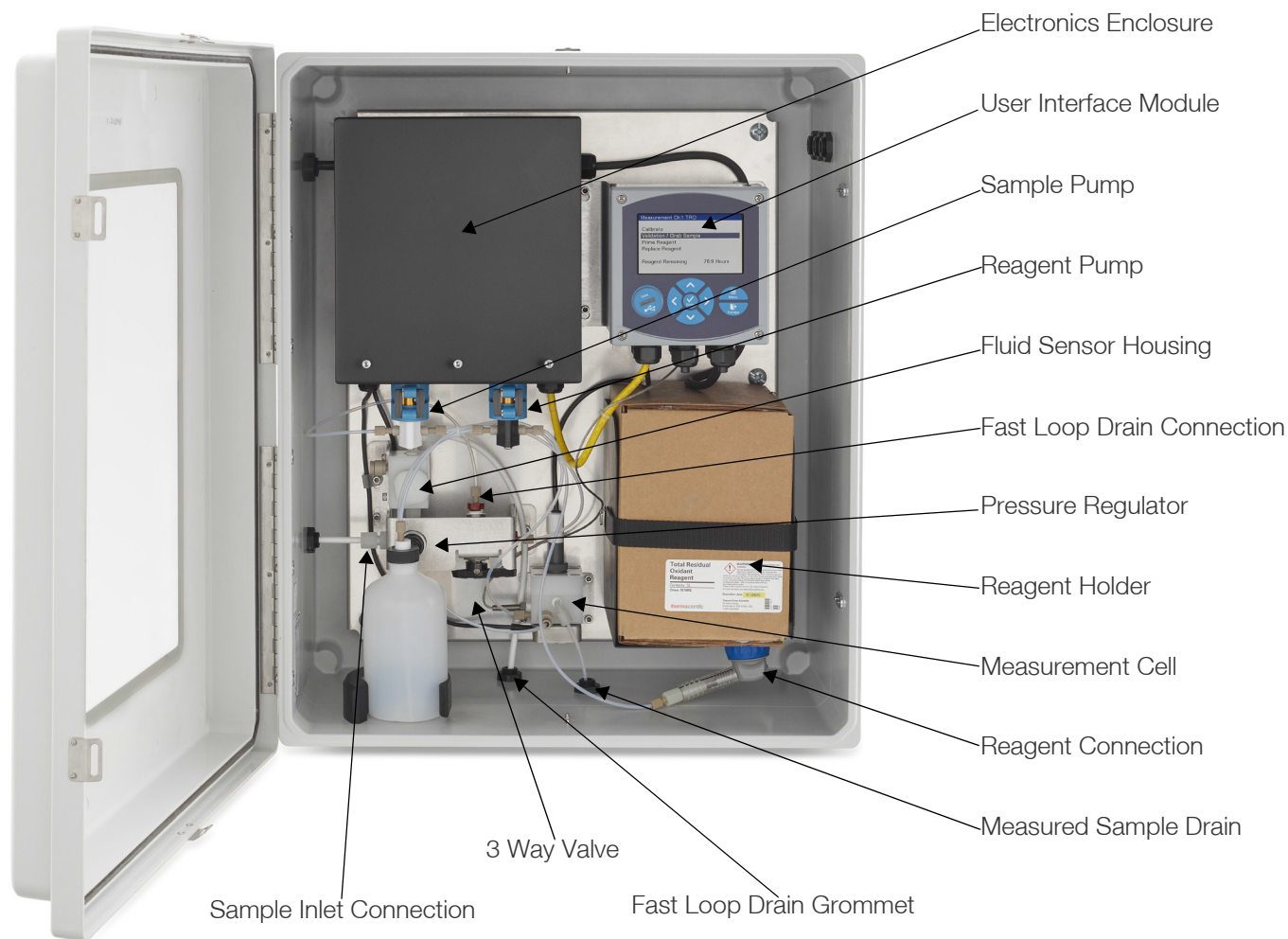

Figure 8. Analyzer Description

The upper portion of the enclosure contains the Display and Electronics necessary for operation. The connection for data and power are also located in the upper portion. The Display contains both the input and communication cards for recording the measurement and sending the data to the central computer system. The TRO sensor and the temperature sensor are wired into the input card inside the display (TRO Card). The communication card comes pre-wired (communication cable to pump controller board). The analog data communication (4-20 mA) is wired by the installer as needed into the TRO Card. For details see **Wiring Diagram**. The lower portion contains the fluidic component required for measurement, reagent storage and sample connection.



Warning: It is recommended that an external sample shut off valve is installed.

Each analyzer **MUST** have its own drain tube vented to atmosphere.

Sample Loop

Sample inlet is located on the left side of the instrument. Sample return and drain connections are made on the bottom side of the instrument. The sample inlet and sample return fittings on the bottom of analyzer require 1/4" OD LLDPE tubing. The measured sample drain fitting at the bottom of the analyzer requires 1/8" OD FEP tubing.

The sample loop is used to obtain water from the sample water and return water to drain through a fast loop. This sample loop is used to enhance response time and to maintain a fresh sample for the analyzer to draw off analytically accurate sample volumes for measurement. An optical sensor located in the sample loop automatically activates the analyzer for on-demand, real-time results and enables minimum consumption of reagent.

Note: The enclosure drain produces no waste under normal use. However, in the event of spills or leaks, some waste may be produced. The analyzer is shipped with all of the internal

tubing attached. Before starting up the instrument, verify that the tubing lines are secured.

TRO measurement sensing electrode

The TRO measurement electrode is a combination style electrode consisting of a platinum sensing element and an iodide reference element. A differential potential is developed across these elements relative to the presence and concentration of iodine in the sample stream. This potential difference signal read by the analyzer in the form of a millivolt signal which is then processed to obtain the TRO concentration.

Automatic Temperature Compensation (ATC)

The temperature sensor is integrated into the TRO Flow Cell and is a resistive element type sensor (30 Kohm thermistor). The temperature signal is passed to the analyzer to provide the sample stream temperature. Automatic compensation software adjusts the resulting measurement to reflect the value which would result if the sample was at calibration temperature.

Reagent

A TRO reagent is used to enhance and stabilize the measurement in a variety of Dissolved Organic Carbon (DOC), Particulate Organic Carbon (POC) and slit conditions found in different cooling water matrix. The reagent is easily installed or replaced with quick connect tube connector and is replaced after approximate 80 hours of active chlorinating or discharging operations.

Startup and Operation

Before starting operation of your Orion 7070iX Total Residual Oxidant Analyzer, please ensure the following:

- Reagent is properly connected.
- Drain and sample lines are connected and sample is available.
- The reagent has been primed. If not, prime the reagent and ensure the reagent line has been filled.

5. Ensure the reagent is fully primed by running the Prime two times (initial instrument install only) to fill the volume of the transfer tube.
6. Inspect the reagent transfer tubing to be sure that it is filled with reagent. Gentle tapping can move air bubbles if they occur. It is important to the accuracy of reagent delivery that no air bubbles are present in the transfer tubing.
7. Installation is now complete.

Placing the TRO Analyzer into Service

Your TRO Analyzer is now ready for routine operation. To place the analyzer into routine service, make sure the 3-way valve points to the left. When the analyzer detects sample water into the analyzer, the analyzer will start running automatically. If the sample flow is stopped, the analyzer will stop running automatically until the sample flow is resumed. To extend reagent life, users are strongly recommended to shut off the sample to the analyzer when no measurement is needed. The user can also control run/stop functionality of the analyzer by using either interval mode or remote start mode.

The TRO Analyzer is designed to run unattended, analyzing sample and self-cleaning/flushing the measurement cell while it is running. All measurement parameters have been pre-programmed at the factory. Consequently, the analyzer is prepared for routine operation once the startup procedures have been completed.

Reagent Installation

Follow the steps to install the reagent.

1. Open the outlet of the cardboard box of the reagent package.
2. Place the reagent box onto the reagent shelf with the dispensing spout pointed upwards.
3. Push the gray / blue cap down onto the dispensing spout of the reagent bag and turn clockwise to secure.
4. Flip over the reagent box, making sure the reagent flows into the tubing and then reinsert the box back into the reagent holder. Secure the box by using the black strap.

Note: Take care to ensure there is no leaking by aligning the threads of the cap with bag threads. A click is felt when cap is locked in place.

Instrument Operation Modes

The setup menu allows the user to run the Orion 7070ix Total Residual Oxidant Analyzer in different modes.

To set the operation mode:

Select Menu > Setup > Channel 1 > Operating Mode

Four options are available:

Continuous mode: The TRO Analyzer will run continuously and readings on the screen will be updated every 2 seconds.

Interval mode: The TRO Analyzer will run at user defined intervals (from 5 minutes to 30 minutes, adjustable in 1 minute increments). The reading on the screen will be updated based on the user defined interval. The TRO analyzer automatically starts running at the last two minutes of each interval period, and reports measurement results for this interval and then stops measurement until the next interval period. The last measurement results will remain on the screen with "last read xx minutes".

Remote mode: The TRO Analyzer can be remotely triggered to start and stop measurement through an input relay. When the analyzer is remotely started, the analyzer will run continuously and update the measurement results every 2 seconds until remotely stopped by the user.

Scheduled Mode: The TRO Analyzer can start measuring automatically at a scheduled starting time and stop the analysis at a scheduled stopping time. The user can setup "Start / Stop" time frames on the Operating Mode screen.

Menu Navigation

Menus are accessed by pressing the MENU key.

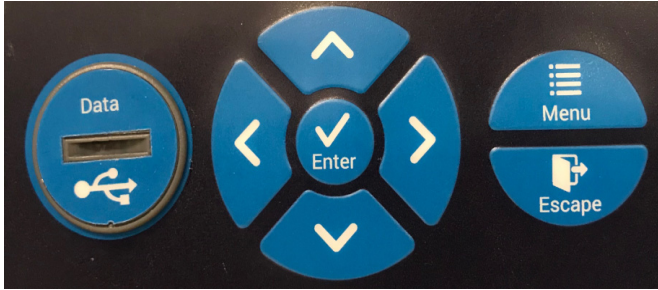
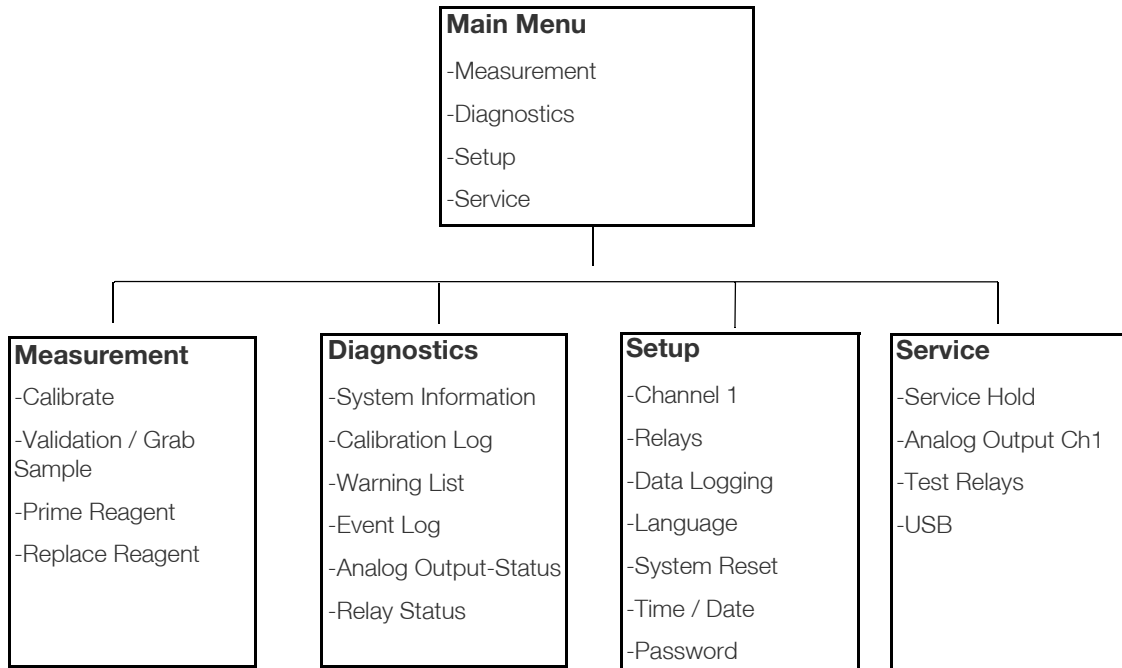

Figure 9. Menu Navigation

- Select the appropriate Up, Down, Left and Right Arrows to highlight desired function.
- Press ENTER to select the highlighted selection and access the available menus and tasks.
- Use the UP / DOWN arrow keys to scroll through the list of Menu options.
- Use the ENTER key to select an option.
- Use the ESC key to move to previous menu and back into the MEASURE screens.



Press the menu key to bring up Main Menu as shown in Figure 10.

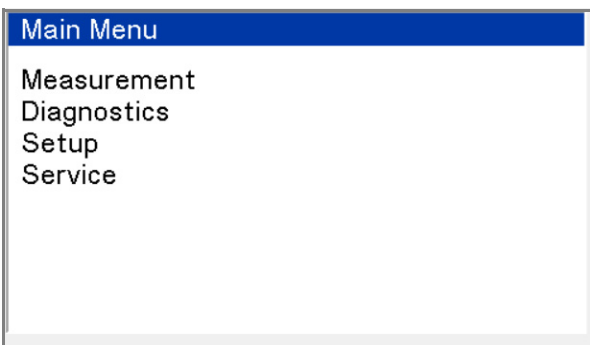

Figure 10. Main Menu

Measurement

By selecting Measurement from the Main Menu the following screen will appear.

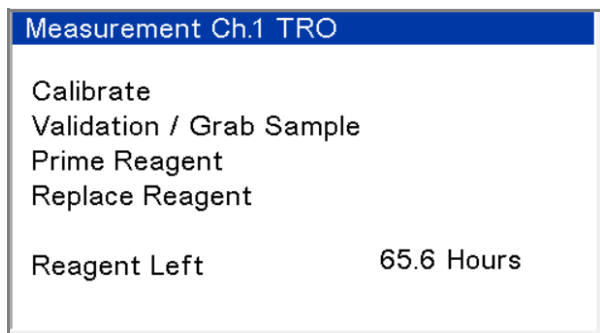

Figure 11. Measurement Screen

Calibrate

Calibrate allows the operator to calibrate either the TRO sensor or the temperature sensor.

The analyzer calibrates using standards with a known chlorine equivalent by setting the monitor using known values. During calibration, the three-way valve is used to switch flow from the sample to the standards line. Two standards are used to adjust the electronics for the actual slope of the electrode much the same manner that two buffers of different pH are required to calibrate a pH meter. Chlorine solutions are unstable and are not suitable for use as standards. Therefore, stock solutions of potassium permanganate, which are stable and react with iodide to produce iodine are used. Standards prepared are stoichiometrically equivalent to the chlorine concentrations indicated. For detailed calibration procedures, please refer to **Startup and Operation**.

Validation / Grab Sample

This option allows for the validation of a known standard or the measurement of a sample using the standards lines.

Prime Reagent

After changing reagent, select this option to prime the reagent pump.

Replace Reagent

After replacing the reagent, select this item to reset the Reagent remaining hours.

Reagent Remaining

This item shows the hours of reagent remaining. This time changes, only when the reagent pump is running or is reset by the “Replace Reagent” selection.

Diagnostics

Select Diagnostics from the Main Menu. The diagnostics screen shows the options as shown in **Figure 12**.

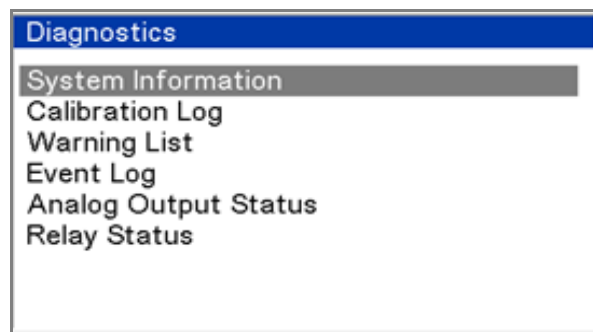

Figure 12. Diagnostics Main Menu

Table 2. Description of Options

Options	Description
System Information	<ul style="list-style-type: none">• Display the channel information of card type• Display the measurement in use• Display the power and relay information
Calibration Log	Select to review the stored calibrations results
Warning List	Contains a description of why the channel indicator is not green. Red and yellow Event possibilities are listed in the Table 3 .
Event Log	This is a log of current and past occurring Events. The log may also contain additional information.
Analog Output Status	Display the mA outputs for the installed channels
Relay Status	Display the status of relay: <ul style="list-style-type: none">• Active• Inactive

Table 3. Event list and the types.

Event	Type
No sample flow	Red
Controller Fault	Red
Reagent Empty	Red
Reagent Low	Yellow

Select Calibration Log option on the Diagnostics screen. The Calibration Log includes historical parameter values (up to the past 12 changes) that were modified by the user for either a 1-point calibration or 2-point calibration. Refer to section **Calibrate** for definition of 1-point calibration or 2-point calibration.

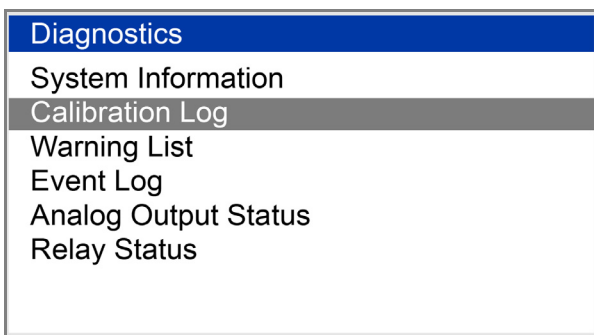

Figure 13. Calibration Log option on the Diagnostics screen

The figure shows an example of the Calibration Log after a 1-point or 2-point calibration was performed.

	Ch.1	TRO
Cal Time:	2019-01-03, 18:41:00	
Slope: 30.3 mV		
Offset: +609.25 mv		
Press ▲ ▼ to view more		

Figure 14. Calibration Log after 1-Point or 2-Point Calibration

Setup

Select Setup from the Main Menu. The setup options are shown in the **Figure 15** below.

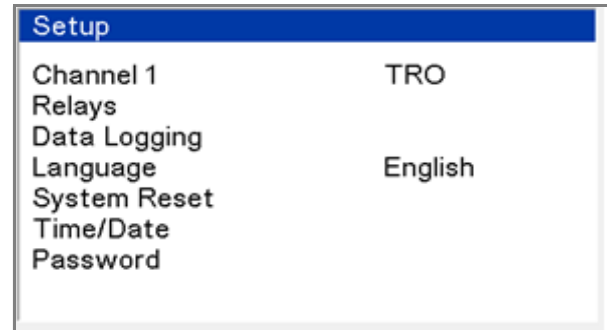

Figure 15. Setup

Channel 1

Select Channel 1 from the Setup screen. The following options are shown.

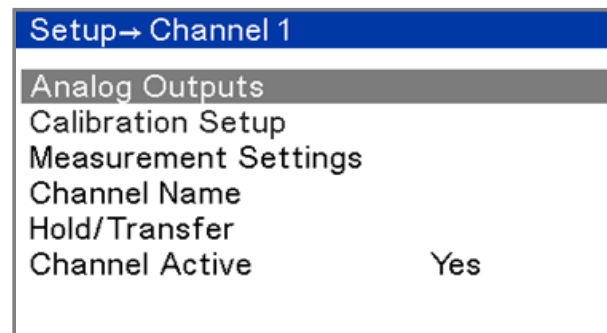

Figure 16. Channel 1 from the Setup Screen

Analog Outputs

Select Analog Outputs from the Setup Channel 1 screen. Analog Output 1 is driven by the sensor and Analog Output 2 is driven by the temperature.

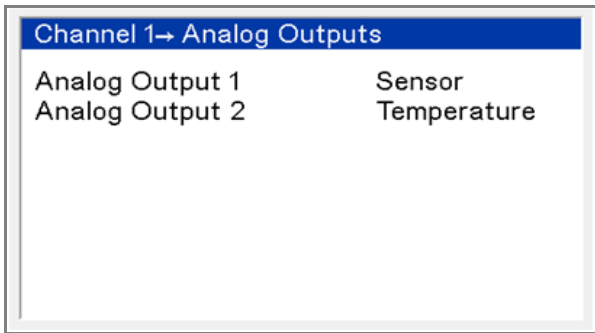

Figure 17. Analog Outputs

Select Analog Output 1. The options appear as shown in the screen. Select the Scale for the output to be 4-20 mA. Choose the function to be either Linear or Log.

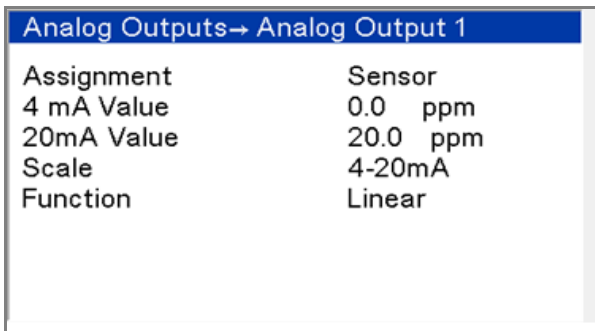

Figure 18. Analog Output-1

Calibration Setup

Set up a calibration reminder for this particular sensor in terms of days. If the sensor is not calibrated after the specified number of days, an indicator on the main measure display screen will turn yellow to indicate the sensor should be checked.

Measurement Settings

Select the Measurement Settings option from the Setup Channel 1 screen. This screen shows the options as shown in **Figure 19**.

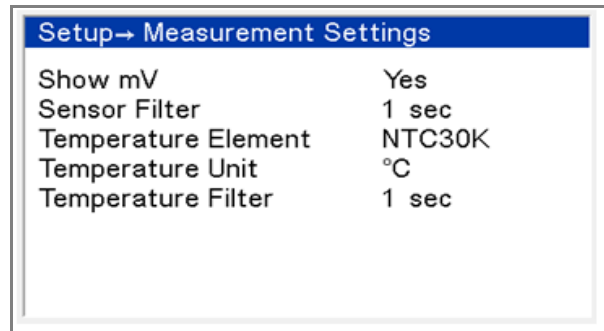
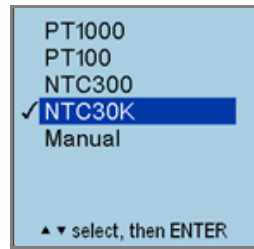

Figure 19. The Measurement Settings from Setup Channel1 Screen

The analyzer is factory configured to the NTC30K temperature element. Do not change this setting.

Channel Name

Enter a tag for the channel to record the measurement information (for example, Basin 31).

Relays

There are three standard relays designated A, B, C. They are located on the power supply block inside the analyzer, with its terminal strip connections, with markings CO (for common or return connection) NO (for normally open) and NC (for normally closed). Each relay can be wired either as NO or NC, in both cases using middle terminal (CO) for return connection. Choosing the correct contact is necessary to achieve the desired logical action.

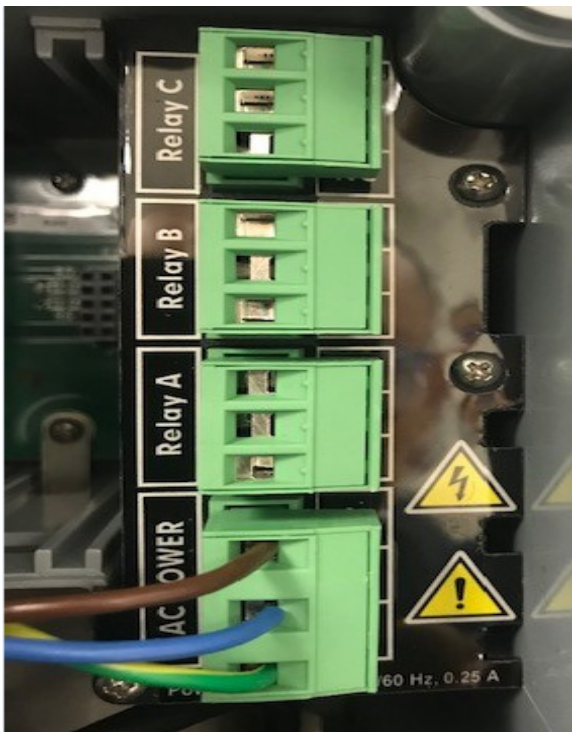

Figure 20. Relays

Data Logging

Set the interval of data recording in minutes.

Language

The analyzer can be set up in the following languages:

- English
- Spanish
- German
- French
- Italian
- Portuguese
- Chinese

System Reset

The factory defaults will restore the analyzer to its original factory setup.

Time / Date

Set the time and date.

Passwords

Set up the passwords to protect system settings and calibration settings. The factory default setup is to have passwords disabled.

Service

Select Service from the Main Menu.

The Service screen shows the following options:

- Service Hold
- Analog Output Ch1
- Test Relays
- USB

Service Hold

Allows the unit to be “on-Hold” for extended periods of time.

Analog Output Ch 1

Set a value to test; calibrate 4 and 20 mA settings so the output agrees with the PLC or recording device.

Test Relays

Toggle Active and Inactive states for each relay in the system.

USB

Load new software and retrieve data-log.

Calibration and Validation

Each Orion 7070iX Total Residual Oxidant Analyzer gets thoroughly wet-tested and calibrated at the factory, so the system is ready to begin analyzing sample streams. The results of this activity are recorded in a Quality Control Report shipped to you with the analyzer.

Since the elapsed time between factory calibration and your startup process is unpredictable, it is important that you calibrate the analyzer again before you place it in service for the first time.

The reported result of a calibration is a number that the analyzer uses to determine the sample concentration. The particular value of this number is not important, but it should be within $\pm 5\%$ of the corresponding value in the Quality Control Report. If so, you can be confident that all subsystems of your analyzer are working properly.

Calibration Standards

The analyzer calibrates using standards with a known chlorine equivalent and setting the monitor to the known value. During calibration, the three-way valve is used to switch flow from the sample to the standards / grab sample line. Two standards are used to adjust the electronics for the actual slope of the electrode in the same manner that two buffers of different pH are required to calibrate a pH meter.

Chlorine solutions are unstable and are not suitable for use as standards. Therefore, stock solutions of potassium permanganate, which are stable and react with iodide to produce iodine are used. Standards prepared are stoichiometrically equivalent to the chlorine concentrations indicated.

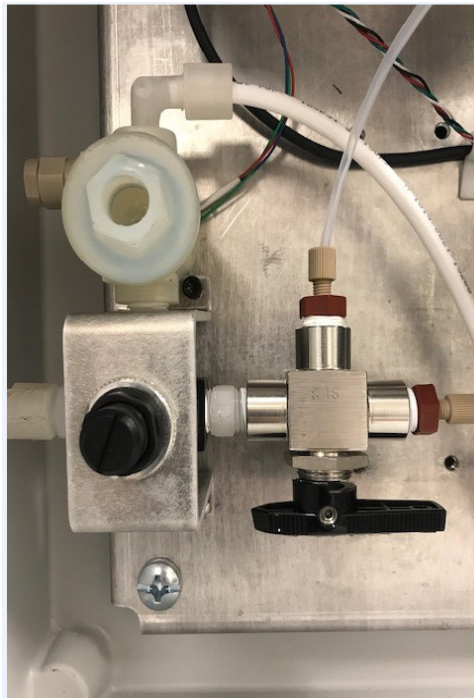

Figure 21. 3-Way Valve

Standards should be chosen to bracket the expected sample concentration and can be prepared by serial dilution of the stock iodate solution described in the Preparing Standards section.

To Prepare Each Standard

1. In a 1000 mL volumetric flask, pipette 0.2 mL of standard solution (UM-272700-A01).
2. Dilute to the mark with distilled water.
3. Ensure complete mixing by inverting the flask at least 20 times.
4. Label the flask: 0.2 ppm Cl_2 .
5. To prepare the 2.0 ppm Cl_2 standard, repeat steps 1 through 4, instead pipetting 2 mL standard solution and label this flask: 2.0 ppm Cl_2 .

You now have two standards, one equivalent to 0.2 ppm and the other equivalent to 2.0 ppm total residual chlorine. For the best accuracy, calibration should be started immediately after the standards have been prepared. Even carefully stoppered standards should be discarded after one hour.

Calibration Procedure for 2-point Calibration and 1-point Calibration

A 1-point or 2-point calibration can be performed on the analyzer. Prior to performing a calibration prepare 1 or 2 calibration standards. If 2-point calibration, prepare two standards that are ten-fold concentration units apart, ideally bracketing expected sample concentration range. Due to the possibility of iodide oxidation to iodine, preparation of standards below 0.01 ppm is not recommended.

1. Select calibrate from the measurement screen.

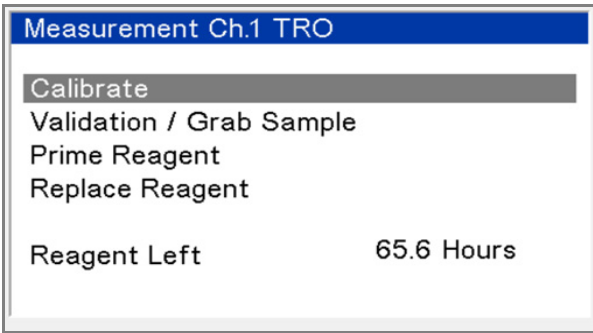

Figure 22. Measurement Ch.1 TRO

2. Follow instructions on the screen to put the inlet valve in the calibrate position.

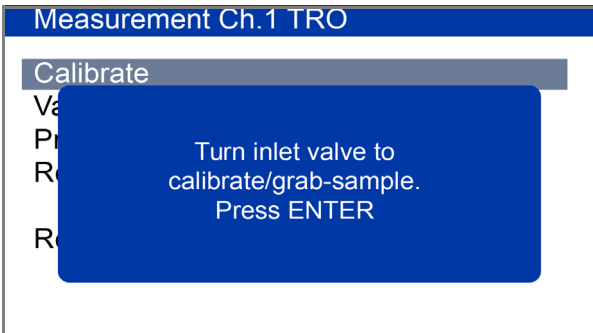

Figure 23. Put inlet valve in calibrate position

3. Select calibrate and continue.

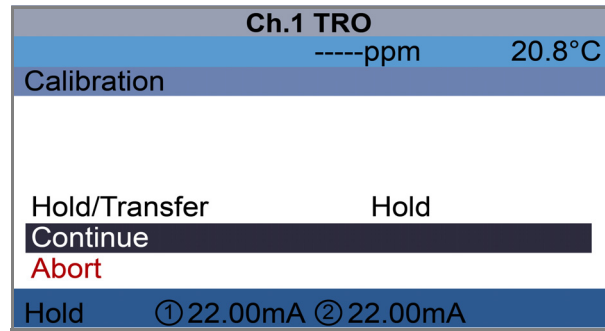

Figure 24. Select Calibrate

4. Select calibrate Sensor for TRO sensor calibration.

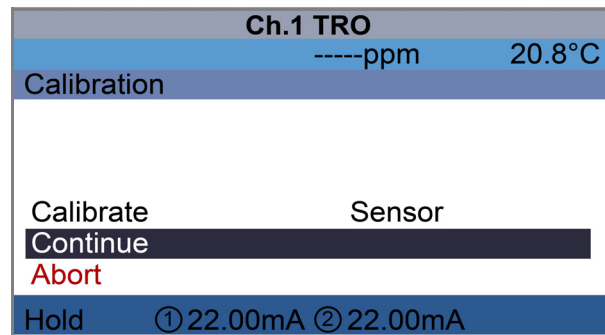

Figure 25. TRO Sensor Calibration

5. Select number of points and press enter.

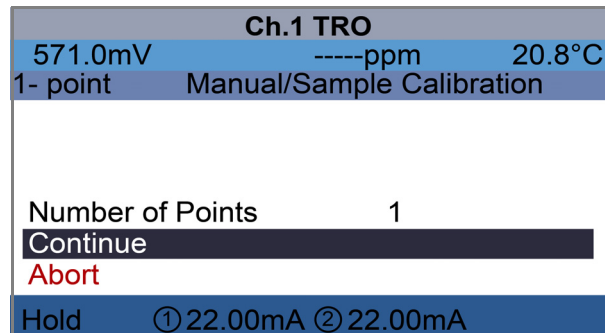

Figure 26. Select number of Points

- Choose from 1-point or 2-point calibration with arrow key.

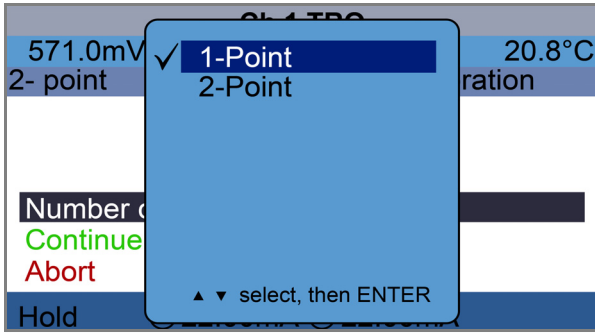

Figure 27. Select 1-Point or 2-Point Calibration

- Press continue for the next step.

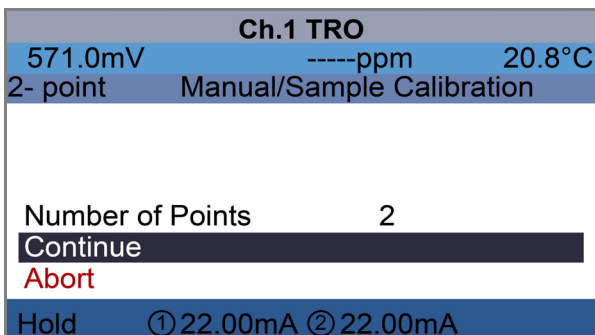

Figure 28. Continue for the Next Step

- Follow the instruction on the screen and place flask that contains Standard solution 1 (lower concentration) in place of the empty grab sampler bottle.

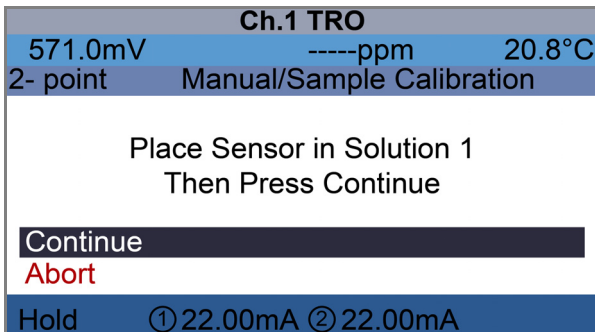

Figure 29. Place Sensor in Solution 1

- Wait until a steady reading is obtained on the monitor. This can be easily seen on the monitor; allow at least 100 mL of the standard to run through.

- After a steady reading is obtained, input the calibration value by selecting and pressing enter.

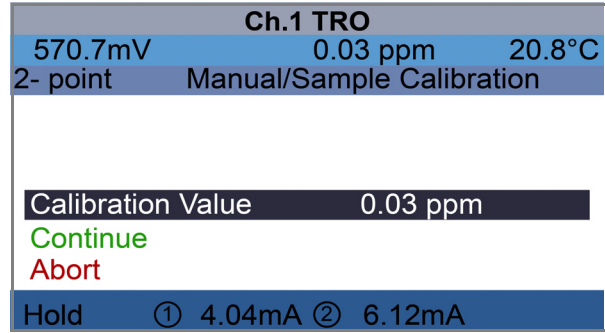

Figure 30. Input the Calibration Value

- Enter the calibration value with arrow keys, left / right arrow key to highlight the digital need to be changed, up / down arrow key to change the value. Press enter to continue.

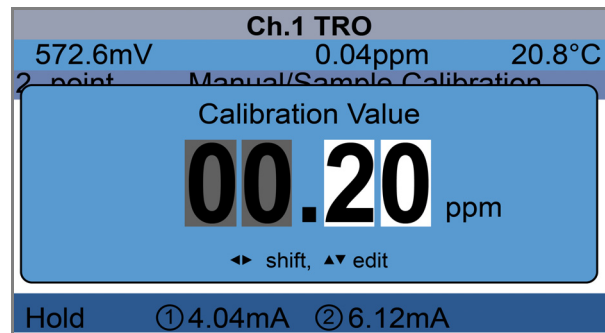

Figure 31. Enter the Calibration Value

- Wait until screen prompts next step.

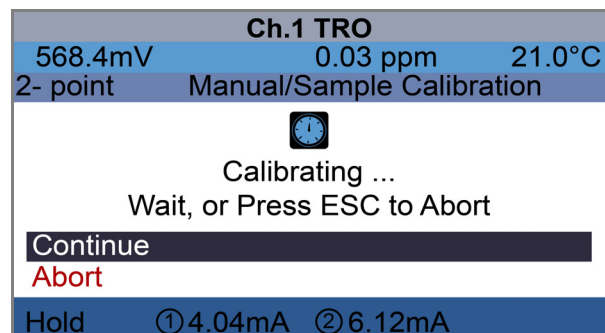

Figure 32. Wait for Next Step

13. If performing a 1-point calibration, jump to the calibration summary screen. For 2-point calibration, we follow the screen for Standard solution 2 (higher concentration) by swapping the standard solution 2 flask in the place of the standard solution 1.

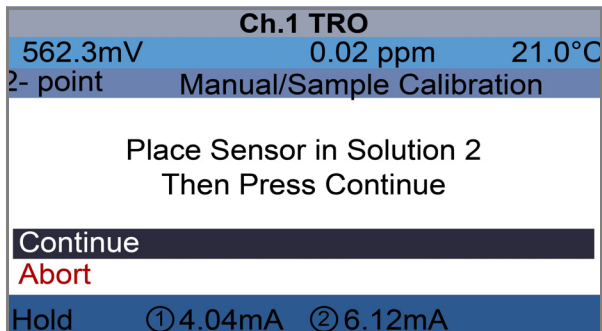

Figure 33. Place Sensor in the Solution 2

14. Wait until a steady reading is obtained on the monitor. This can be easily seen on the monitor; allow at least 100 mL of the standard to run through.

15. After a steady reading is obtained, input the calibration value by selecting and pressing enter.

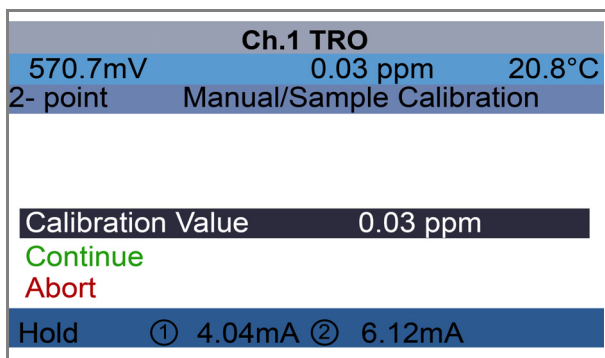

Figure 34. Input the Calibration Value

16. Enter the calibration value with arrow keys, left / right arrow key to highlight the digital need to be changed, up / down arrow key to change the value. Press enter to continue.

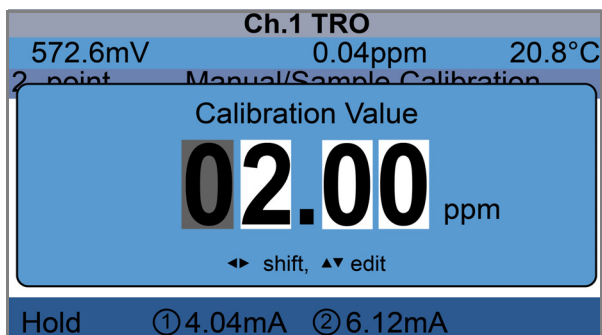

Figure 35. Enter the Calibration Value

17. Wait until screen prompts next step.

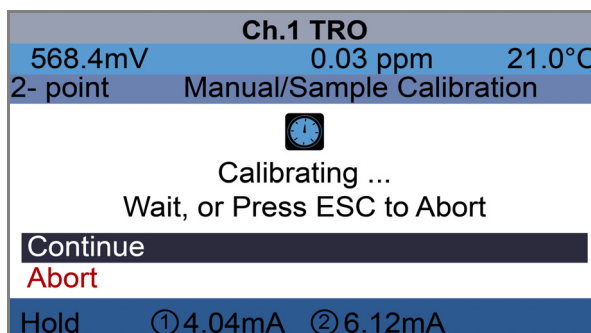

Figure 36. Wait for Next Step

18. While calibration is finished, calibration results will shown on the screen and store in calibration log.

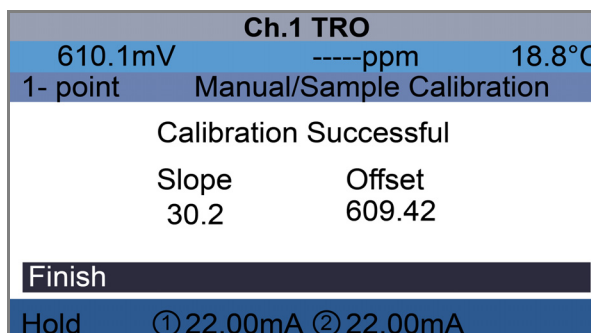

Figure 37. Calibration summary screen

19. Turn the three-way valve to the left, so that the monitor is drawing sample from the inlet block. The monitor is now calibrated and set for continuous, unattended operation.

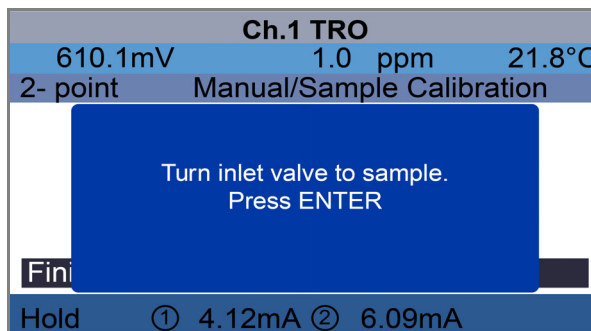

Figure 38. Sample from the inlet block

20. Recalibration will be necessary should the TRO electrodes be changed or the reagent replaced. Refer to the calibration notes in section **Monthly Maintenance**.

Measure a Grab Sample or Performing a Validation

You can check the analyzer's calibration accuracy at any time using the validation function. Validation consists of running a measurement and reporting the result in concentration. This reported result can then be compared to the expected value, which is the known concentration of the validation solution, to determine the accuracy of system calibration.

The advantage of using this function over the Run Analysis function is that prior knowledge of the concentration allows for validating the accuracy of the analyzer, without affecting the data reporting to your control center or device.

The validation is similar to the measurement except that the sample source is from a known concentration solution. The known concentration solution is poured into the provided grab sample bottle, put the grab sample bottle cap back onto the bottle, then rotate the bottle clockwise to cap the bottle. Turn the 3-way valve to grab sample position.

To start the validation process, click Menu--> Measurement--> Validation / Grab Sample and then follow the instructions on the screen.

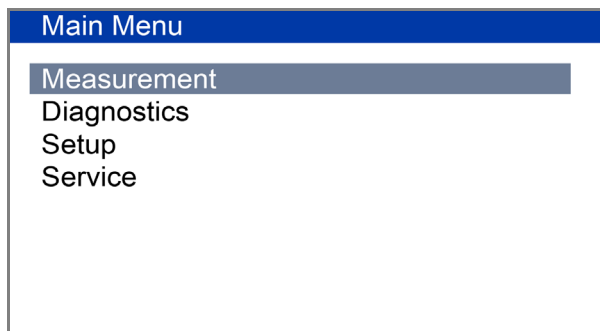

Figure 39. Click Measurement

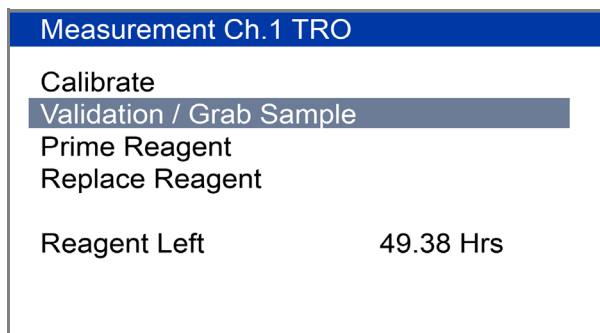

Figure 40. Select Validation / Grab Sample

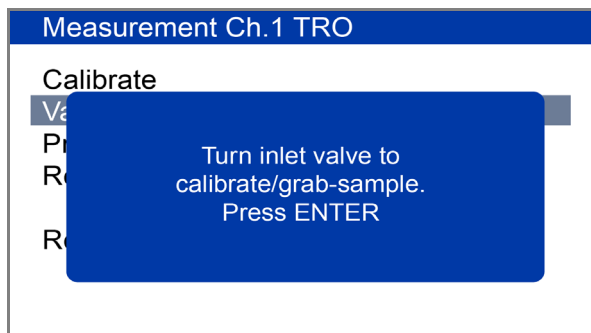

Figure 41. Just press 'Escape' until screen shows no sample

When grab sampling is completed, press 'Escape' until you reach the measurement screen.



WARNING: Make sure there is enough sample in the grab sample bottle testing. Running the analyzer for long time without sample may damage the pumps.

The Validation/Grab sample is similar to the standard measurement except the sample/standard is from a grab sample bottle.

The user uses the grab sample bottle to measure grab samples taken from other areas in their system or to measure a standard for calibration verification.

- Collect 350 - 600 mL of the sample or standard in a clean container.
- Rinse the grab sample bottle with the collected sample or standard multiple times.
- Pour the rest of sample or standard into the grab sample bottle and place the bottle into the grab sample holder.
- Select **Menu > Measurement > Validation/Grab Sample**.
- Complete the instructions on the display.

Note: When performing a Validation/Grab sample, with the TRO analyzer, the user should remain in front of the analyzer and make sure there is enough sample/standard to finish the measurement. Prolonged running of the analyzer without sample/standard may permanently damage the sample/standard pump and/or the analyzer, which is not covered under warranty.

Collecting a Grab Sample from the TRO Analyzer

Use the sample water fast loop drain tube to manually collect a sample from analyzer for reference analysis. The sample source will also be measured by the analyzer immediately after the sample is collected. The value of the sample source should be recorded and used when comparing the analyzer's measurement with a reference method.

Note: The concentrations of samples collected from different sampling points may vary quite differently. The user needs to use the sample from the fast loop as the reference sample.

Maintenance and Troubleshooting



WARNING: To reduce the risk of shock hazard, AC Mains power must be turned off or disconnected prior to opening any electronics enclosures within the Analyzer.

Extended Shutdown

If analyzer is planned to stop running over 2 weeks, extended shut down need to be performed. To avoid clogging, flush the entire system with distilled water before shutdown. Disconnect and empty out the reagents box and flush the lines by using distilled water in the grab sample bottle. Put reagent cap in a beaker contains distilled water. Use the Grab Sample Analysis for 15 minutes to allow for extended flushing. Remove the electrode from the flow cell and let it hang dry by its cable.

Complete Removal

For complete removal from service, disconnect the equipment using the following steps:

1. Remove electric power through appropriate local Lock out / Tag Out procedures.
2. Shutoff flow to the TRO analyzer.
3. Remove reagent from the analyzer.
4. Disconnect all tubing connected to the TRO analyzer.
5. Remove the mechanical fasteners for complete removal.

Sensor

The TRO sensor should be inspected every 6 months for damage or discoloration. If necessary, it can be refurbished or replaced.

Reagent

A 5 liter container of reagent is sufficient for approximate 80 hours of continuous operation.

Changing Reagents



CAUTION: Wear gloves or protective equipment your site may require when changing reagents. Flip the reagent box so the dispensing spout is on top of the box. Push the gray / blue cap down onto the dispensing spout of the reagent bag and twist counter-clock to remove the cap from reagent bag. Do NOT re-use or re-fill old or existing reagent boxes. Dispose of the used boxes and contents safely and according to local regulations. Follow **Reagent Installation** to install a new box of reagent. After installing reagent, select **Reset Reagent** from the measurement menu. Then select **Prime Reagent**. Repeat **Prime Reagent** if you notice air bubbles in the tubing.

Cleaning

Follow the instructions in **Extended Shutdown** for cleaning the analyzer.

Decontamination and Disposal of Reagent

For decontamination and reagent clean up, follow local laws and regulations. SDS of the reagent is available from Thermo Fisher Scientific.

Troubleshooting

The following procedures instruct how to locate, evaluate and fix a problem when TRO analyzer issues an alarm.

Table 4. Alarm Guide

Problem	Additional Observations	Root Cause	Solution
No Sample Flow (red banner)	Display value - - -	No Sample in Flow Sensor	Investigate sample input
Reagent Empty (red banner)	Display value - - -	Reagent is empty	Replace the reagent. Also select “Replace Reagent” from the menu to reset time
Reagent Low (yellow banner)		16 hours of reagent remaining	Check reagent inventory, buy reagent if needed
Controller Fault (red banner)	Display value - - -	There is a problem with the reagent or sample pump	Power-cycle the unit. If still persists, contact technical support
Default calibration (yellow banner)		Factory calibrated: recommend to do a 2-point calibration on site after initial installation and start up.	Perform a 2-point cal
Hold (yellow)		Waiting for stable reading of 4-20 mA output	Wait for 2 minutes

Table 5. Troubleshooting Guide

Problem	Additional Observation	Root Cause	Solution
Instrument bias (reading drifted from standard)	After calibration, Bias in the reading of DI water ≥ 0.03 ppm; or bias ≥ 0.03 ppm for standard solution	Reagent oxidized;	Call Thermo Fisher; replace reagent with new reagent
	After calibration, bias goes away	Calibration was off	Recalibration solved the issue
Process sample from sample line did not read right	3-way valve pointing to the right (taking grab sample)	Wrong valve position; to the right for grab sample; to the left for sampling from sample line	Turn valve to the left
Grab sample did not read right	3-way valve to the left (taking inlet sample)	Wrong valve position; to the right for grab sample; to the left for sampling from sample line	Turn valve to the right

Table 5. Troubleshooting Guide

Problem	Additional Observation	Root Cause	Solution
Instrument screen read ---- ppm	No flow to analyzer; no drain in waste line while only drain from fast loop	Flow valve shut off to analyzer; or pump that supplied flow stopped; Pressure was too low to supply water to analyzer (needs > 5 psi)	Resume flow by providing the need water pressure with pump on or turning on flow switch or valve to allow flow to analyzer
	In Remote control mode or scheduled mode during off periods	Remote control and scheduled control can turn off analyzer and turn on analyzer.	Wait until scheduled time for measurement or turn on measurement in remote mode
	Has flow to analyzer and drain through both waste line and fast loop line	Flow sensor failure	Replace flow sensor; Call technical service
TRO reading fluctuating wildly to higher or low (e.g. -99)	Mostly stable, occasionally very high or very low readings.	Air bubbles trapped in measurement cell close to ISE probe	Take out ISE probe and let water refill measurement cell at full level; then put it back

Maintenance Schedule

Weekly Maintenance

Leak Check Look for leaks at any of the fittings and tighten as required.

Verify Monitor Reading Take a grab sample for analysis according to the procedure in the Grab Sample Analysis section.

Monthly Maintenance

Clean Inlet Filter (if used).

Calibration

The monitor should be calibrated monthly or at the same time that reagent is changed. After the installation of a new electrode, the monitor should be re-calibrated 48 hours after the initial calibration. It will be found that for most applications, there will be little, if any, difference. Some waters with a very high organic content might show an initial shift in calibration point which will then remain stable after a day or two of operation.

Quarterly Maintenance

Tubing that is exposed to sample with reagent should be changed every 90 days. The tubing may also have to be changed more frequently if the sample is heavily loaded with suspended solids. The supplies list contains replacement tubing and fittings, Cat. No: 7070TK. Be sure that the white, translucent Teflon tubing is used to replace sample and standard tubes containing iodine solution. Iodine is absorbed by other plastic tubing materials, affecting monitor accuracy.

Yearly Maintenance

1. Replace the sensing electrode.
2. Replace O-rings and grommets as required (included in the electrode kit), Cat. No 7070EK.
3. Clean the optic sensor in the sample chamber.

Updating the Software

Use a USB Drive with an upgrade file to update the firmware for the TRO Analyzer.

- Select **Menu > Service > USB > Load New Software**.
- Follow the instructions on the screen.

Parts and Accessories

Cat. No.	Description
Reagents and Standards	
7070IX	TRO Process analyzer
7070CK	Calibration kit, TRO standard 1000 ppm
7070RE	TRO reagent, 2 x 5 liters
Maintenance Items	
7070EK	Electrode kit for 7070iX (100020S)
7070TK	Tubing kit for 7070iX, for tube and cell cleaning
7070FLT	Filter Strainer for TRO analyzer

Certificates

The Orion 7070iX Total Residual Oxidant Analyzer is designed to meet the following standards as shown in table.

Ingress Protection	IP54
Product Safety	cTUVus, CE
EMC	CE: EN61326-1, FCC: Class A, ISED: CAN ICES-1/NMB-1, KC, RCM.

Product is evaluated to current 61010-1 safety standards.

Certifications:



FCC USA

“This equipment has been tested and found to comply with the limits for a Class A digital device, pursuant to part 15 of the FCC Rules. These limits are designed to provide reasonable protection against harmful interference when the equipment is operated in a commercial environment. This equipment generates, uses, and can radiate radio frequency energy and, if not installed and used in accordance with the instruction manual, may cause harmful interference to radio communications. Operation of this equipment in a residential area is likely to cause harmful interference in which case the user will be required to correct the interference at his own expense.”

Industry Canada

“This ISM device complies with Canadian ICES-001. Cet appareil ISM est conforme à la norme NMB-001 du Canada”

Korea EMC Warning

Warning Statement EMC Registration is done on this equipment for business use only. It may cause interference when the product would be used in home.

This warning statement applies a product for business use.

사용자안내문

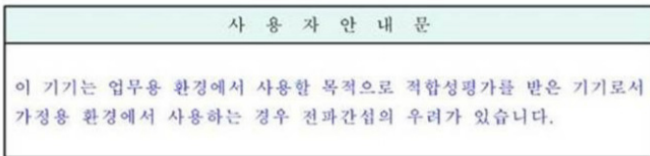

※ 사용자 안내문은 “업무용 방송통신기자재”에만 적용한다.

Specifications

Table 6. Product Specifications

Measurement Performance	Measuring Range	0.001-15 ppm
	Accuracy	Less than 5% of reading or 10 ppb, which ever is greater from 0.001-15 ppm
	Resolution	0.001 ppm in all ranges
	Response Time	95% within three minutes
	Precision	±2% of reading or ±10 ppb, whichever is greater from 0.001-15 ppm
	Limit of Detection	0.001 ppm
	Method	Based on electrode 9770 ISE EPA approved standard method
Environmental	Ambient Operating Temperature	5 to 45 °C (41 to 113 °F)
	Maximum Humidity	85% at 40 °C (104 °F)
Sample Requirements	Sample Flow	40 mL/minute
	Sample Pressure	5-50 psig
	Sample Supply	Continuous
	Sample Temperature Range	5 to 45 °C (41 to 113 °F)
	Max TSS	1000 ppm
	Max particle size	130 microns
	Max Turbidity	500 NTUs
	Chlorine	up to 20 ppm
	Sample Inlet/Outlet Connections	1/4" LLDPE Tubing - length 2 ft min
	Drain Tubing	1/8" LLDPE Tubing - length 2 ft min
	Sample Streams	One
Construction	Enclosure Integrity	IP54
	Enclosure Dimensions	27.9 inches x 18.8 inches x 12.4 inches 709 mm x 478 mm x 315 mm
	Shipping Weight	20 kg (45 lbs) without reagent
Electrical	Power Requirements	100 - 240 VAC, 50/60 Hz, 40 watts

Table 6. Product Specifications

Data and Control	Current Loops	Two 0/4-20 mA (isolated). Maximum 900 ohm load.
	Remote Start	2 Wire Electrically Isolated Input Isolation: 500 VDC Input Signal Range: +3 VDC to +5.5 VDC (referenced to -side signal)
Regulatory	Safety	CE: EN/IEC61010-1, cTUVus
	EMC	CE: EN61326-1, FCC: Class A, ISED: CAN ICES-1/NMB-1, KC, RCM.

***Additional filtration may be required.**

User Interface:

- Display: 4.3 - Inch Color Graphics with High Contrast.
- Keypad: 7 Key Menu Navigation.

4 to 20 Milliamp Current Loops

- Two isolated current loops.
- 900 Ω (maximum) load.
- Setup 4 to 20 mA. (Software configurable).
- 0.01 mA Resolution.
- Each output assignable to sensor, temperature.
- Loop power provided by Analyzer.

Relays

- Three Form C Relays: 1 A, 250 VAC.
- Normally Open and Normally closed contacts.
- Assignable to TRO measurement or temperature.

Remote Start input:

- 2 Wire electrically isolated input.
- Isolation: 500 VDC.
- Input signal range: +3 VDC to + 5.5 V VDC (referenced to – side signal).

Customer Service

Notice of Compliance

This analyzer may radiate radio frequency energy and may cause interference to radio communications if not installed and used properly in strict accordance with the manufacturer's instructions. This analyzer has been tested and found to comply with the limits for a Class A digital device pursuant to Subpart B of Part 15 of FCC Rules, which are designed to provide reasonable protection against such interference in a commercial environment. Operation of the analyzer in a residential area may cause interference, in which case the user, at his own expense, will be required to take whatever measures may be required to correct the interference.

This Class A digital apparatus complies with Canadian ICES-003.

The Thermo Scientific Orion 7070iX Total Residual Oxidant Analyzer is CE and cTUVus certified, which includes testing to EMC and US and Canadian standards.

Consumables

Consumables can be ordered from Thermo Fisher Scientific or your Thermo Fisher Scientific-authorized distributor. Use only Thermo Fisher Scientific products or Thermo Fisher Scientific-approved products in your Thermo Scientific Analyzer. Thermo Fisher Scientific shall not be liable for damage to or malfunction of the system, which it deems was caused by the use of unauthorized materials.

Assistance

After troubleshooting all components of your measurement system, contact Technical Support. Within the United States call 1.800.225.1480 and outside the United States call 978.232.6000 or fax 978.232.6015. In Asia, Europe, the Middle East and Africa, contact your local authorized dealer. For the most current contact information, visit www.thermofisher.com/water. For the latest application and technical resources for Thermo Scientific Orion products, visit www.thermofisher.com/water.



Orion 7070iX TRO Analyzer -

Global support - with experience that comes from supporting our customers for over 50 years throughout the world, our water quality specialists and customer support teams offer a quick, thorough and professional response to any problem encountered.

Focus on user benefits -

we work closely with you to define your needs, and ensure you are using the analyzer in a way that improves your bottom line. For more information, contact your local water quality specialists, call 1-800-225-1480 or visit www.thermofisher.com/processwater.

Thermo Fisher Scientific Inc.
22 Alpha Rd,
Chelmsford, MA
01824, USA

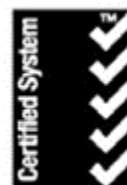

*Thermo Fisher Scientific
Water Analysis Instruments
Chelmsford, MA USA
Quality Management System
Registered to ISO 9001*

Find out more at thermofisher.com/processwater

Australia: (613) 9757-4300 In Australia: (1300) 735-295
China: (86) 21-6865-4588 Germany: (49) 6184-90-6321
India: (91) 22-4157-8800 Japan: (81) 045-453-9175
North America: 1-978-232-6000 Toll Free: 1-800-225-1480
Singapore: (65) 6778-6876

ThermoFisher
S C I E N T I F I C