



## Sorvall CC40NX and CC40SNX Ultracentrifuge Series

GMP-compatible, scalable, continuous-flow ultracentrifuges for automated purification or concentration of viral and nanosize particles

# Free yourself from your process

Advanced, industry-leading features mean consistent, repeatable, and worry-free process execution

Flexibility in separating your nanosize particles 4–5

Separate your nanosize particles by continuous-flow or batch-mode ultracentrifugation using density-gradient or pelleting techniques

Automation: process control and sample integrity 8–10

Program your specific recipe and execute automated custom operations while maintaining the integrity of your samples

Reduced cost of ownership 12

Unlike other suppliers' units, the Thermo Scientific™ Sorvall™ CC40NX and CC40SNX ultracentrifuges do not require capital expense investments for noise control devices or other utilities



Thermo Scientific™ Integrated Process Control (IPC)  
Automated operation and cross-contamination prevention



## Flexibility in scaling your process

6–7

Scale up your process, up to 200 L batch, or create a small-scale model down to 0.2 L while keeping full parameter linearity

---

## GMP-compatible

11

GMP-ready ultracentrifuge supports CFR 21 Part 11 compliance with full document and associated validation services

---

## Minimized time to commercialization and maximized uptime

13

Full-service support to minimize your time to commercialization and maximize your equipment uptime

**Thermo Scientific™ Sorvall™ CC40NX Large-Scale Ultracentrifuge**  
GMP-compatible, flexible, and scalable separation of nanosize particles



# Flexibility in separating nanosize particles

**Thermo Scientific™ Sorvall™ CC40 series ultracentrifuges feature different rotor core types, diverse modes of operation, and custom-recipe programmability. These features enable this series to be used across a broad spectrum of applications, including viral purification and concentration in vaccine manufacturing and AAV polishing in cell and gene therapy.**

- Egg-based virus vaccine purification and concentration: influenza vaccine, rabies vaccine, yellow fever vaccine, tick-borne encephalitis vaccine
- Bacterial vaccine purification: Haemophilus influenza type b vaccine
- Cell-based vaccine purification and concentration: influenza vaccine
- Adenovirus vector and AAV polish: all serotypes

Sorvall CC40 series ultracentrifuges have up to 21 different rotor core types available. These rotor cores enable you to optimize against your process needs by offering varying maximum force (up to 118,000 x *g*), capacities (up to 8.0 L), materials, and separation characteristics. Refer to Table 1 for a subset of rotor core types and applications.

Sorvall CC40 series ultracentrifuges have four diverse modes of operation—continuous flow, batch zonal, pelleting, and density gradient—that allow you to work across a multitude of applications or optimize for your specific critical product. Refer to Table 1 for rotor core types and modes of operations. Refer to Figure 1 for a schematic of how separation is achieved in continuous-flow density-gradient mode.

**Table 1. The different rotor core types and mode of operations for separation by ultracentrifugation.**

Applications	CC40NX core	Max speed/ max RCF	RCF at max core radius	Capacity	Material
Continuous-flow isopycnic separation, which enables pelleting and clarification of the sample in the effluent	Core (D2) Core (H)	40,000 rpm/ 118,000 x <i>g</i>	98,000 x <i>g</i> at 5.5 cm	3.2 L	NORYL™ resin Titanium
Continuous-flow and batch-mode isopycnic separation	Core (H) series	40,000 rpm 118,000 x <i>g</i>	98,000 x <i>g</i> at 5.5 cm	0.2 L , 0.4 L, 0.8 L, 1.6 L, 3.2 L	NORYL resin
Batch rate–zonal separation	Core (E)	40,000 rpm 118,000 x <i>g</i>	30,400 x <i>g</i> at 2.1 cm	8.0 L	NORYL resin
Similar application as Core (D2), with added pre-clarifier on the sample entrance	Core (F)	40,000 rpm 118,000 x <i>g</i>	98,000 x <i>g</i> at 5.5 cm	3.2 L + 0.3 L	NORYL resin
Large-volume continuous-flow isopycnic separation	Core (G)	40,000 rpm 118,000 x <i>g</i>	48,300 x <i>g</i> at 2.7 cm	7.7 L	NORYL resin Titanium

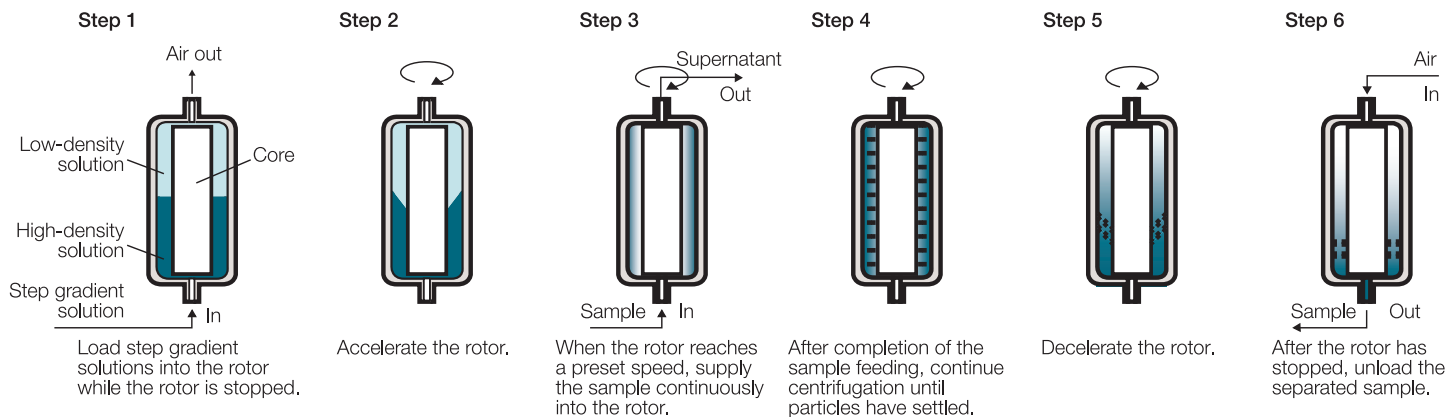

Figure 1. The 6 steps of separation inside the ultracentrifuge in the continuous-flow density gradient.

Your process and your product are unique, so your choice in separation technology should offer the flexibility you need with custom-recipe programmability. Sorvall CC40 series ultracentrifuges offer an optional IPC equipped with state-of-the-art custom-recipe programming that allows you to customize and optimize your product process by adjusting key parameters such as speed, time, temperature, product flow rate, product flow direction,

product flow path, and product sensor fractionation target values (e.g., absorbance, concentration). Programmability means you can minimize operator errors and focus on a highly reproducible process that optimizes the concentration, isolation and purification of your critical product. Refer to Figure 2 for an example of the workflow process and programming steps.

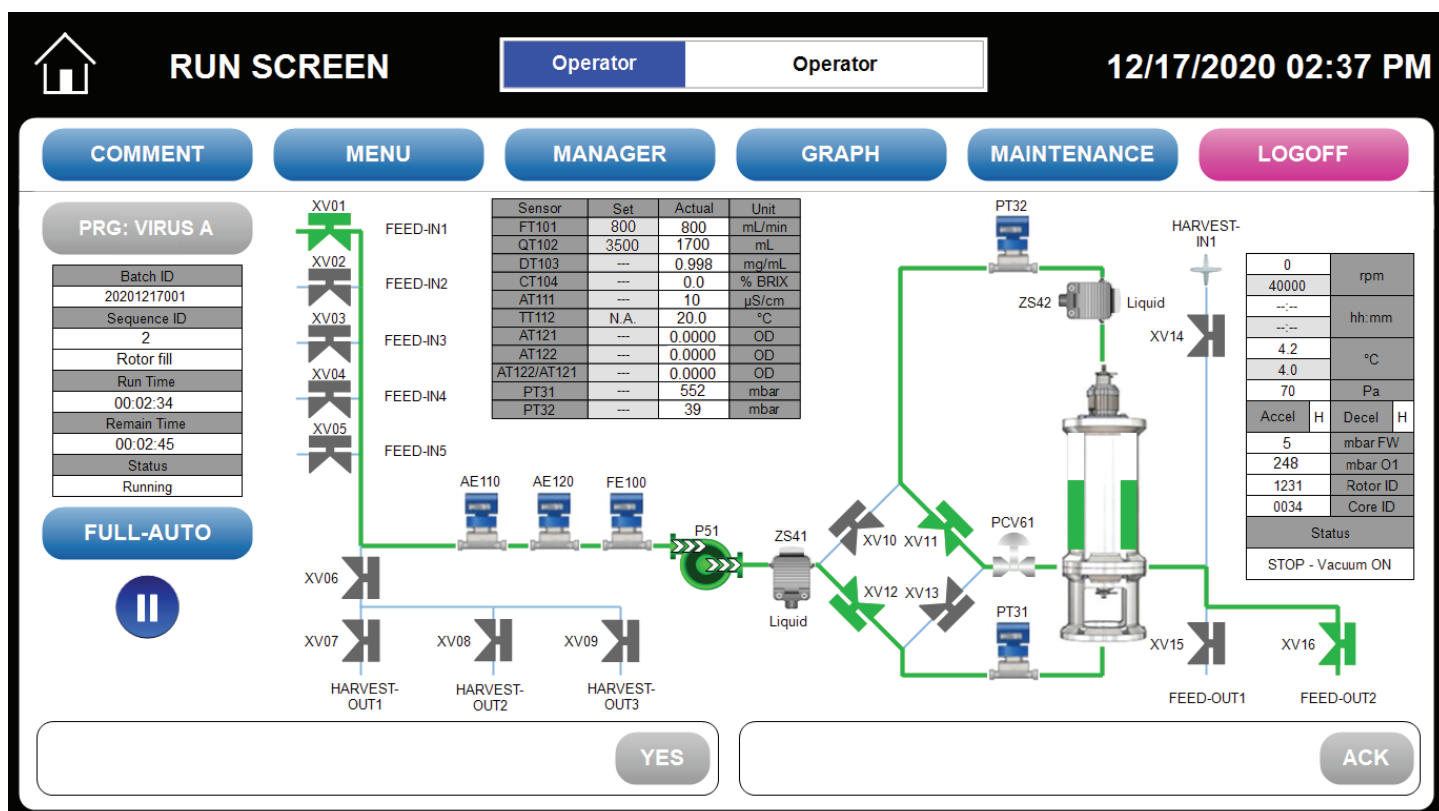

Figure 2. The flexibility to program the separation of a specific ultracentrifuge workflow process.

# Flexibility in scaling your process

**Working in a GMP environment means that you need to comply with strict regulations and guidelines that span the life cycle of your product. Being able to scale within, and between, stages (from R&D to pilot through to production) in a single, validated, and linearly scalable solution is critically important in reducing your time to commercialization and validating your systems and processes for GMP compliance.**

The Sorvall CC40 series ultracentrifuges provide flexibility in scaling your process by offering a wide-ranging choice of linearly scalable rotor cores and by a choice of two different machine sizes.

There are 11 different linearly scalable rotor cores (refer to Figure 3 for a subset of cores), spanning 0.2 L up to 3.2 L (rotor core volume capacity), enabling you to scale up your process or create a small-scale model of your large-scale process by exchanging the insert core of your existing Sorvall CC40 series ultracentrifuge.

Two different models (refer to Table 2) enable you to scale through your product life cycle. The Sorvall CC40SNX ultracentrifuge is suitable for low-volume applications or in early stages such as R&D and pilot, with 1.6 L max rotor core volumes, and capable of processing up to 100 L. The Sorvall CC40NX ultracentrifuge is suitable for high-volume applications or in production stages, with 8 L max rotor core volumes, and capable of processing up to 200 L. The units are linearly scalable thereby ensuring that your R&D, scale up, and production processes are equivalent and GMP-compatible.

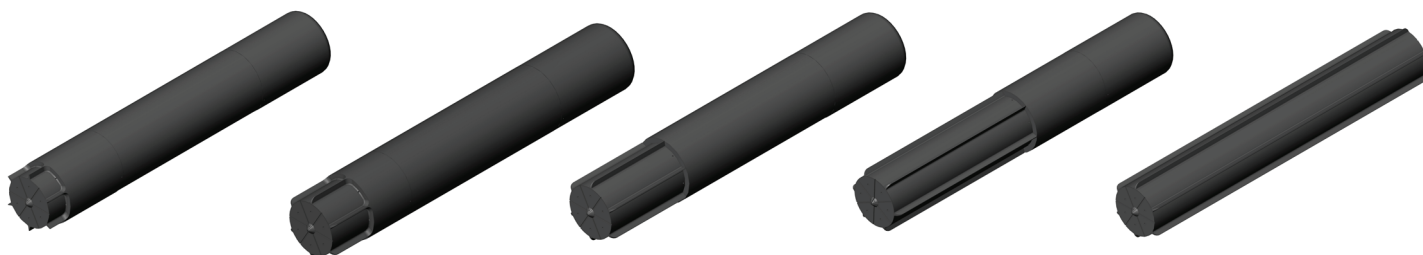

**Figure 3. The 1:1, 2:1, 4:1, 8:1, 16:1 linear scale ratio insert cores.** The separation parameters are maintained identical and the choice of cores and flow rates determines the path length and process volume.

**Table 2. The Sorvall CC40NX and the Sorvall CC40SNX ultracentrifuges enable you to scale through the product life cycle.**

	Sorvall CC40SNX	Sorvall CC40NX
Scale	Research & development Pilot production Low-volume production	Research & development Pilot production Low-volume production High-volume production
Minimum rotor volume	0.2 L	0.2 L
Maximum rotor volume	1.6 L	8.0 L
Process volume	Up to 100 L	Up to 200 L

Being able to scale through the product life cycle is important, but it is equally important to be able to scale within different steps of your process. Your process is complex and operates at different volume scales. By having two different models, you are capable of adapting to the specific volumetric needs of your steps. For example, influenza vaccine manufacturers create a downstream process train using the Sorvall CC40NX and

Sorvall CC40SNX ultracentrifuges at two different steps in their vaccine production process: the Sorvall CC40NX ultracentrifuge for primary downstream purification with high-input volumes and the Sorvall CC40SNX ultracentrifuge for secondary downstream purification with lower-input volumes. Refer to Figure 4 for an overview of the influenza vaccine production process and the use of the Sorvall CC40 series ultracentrifuges at different steps.

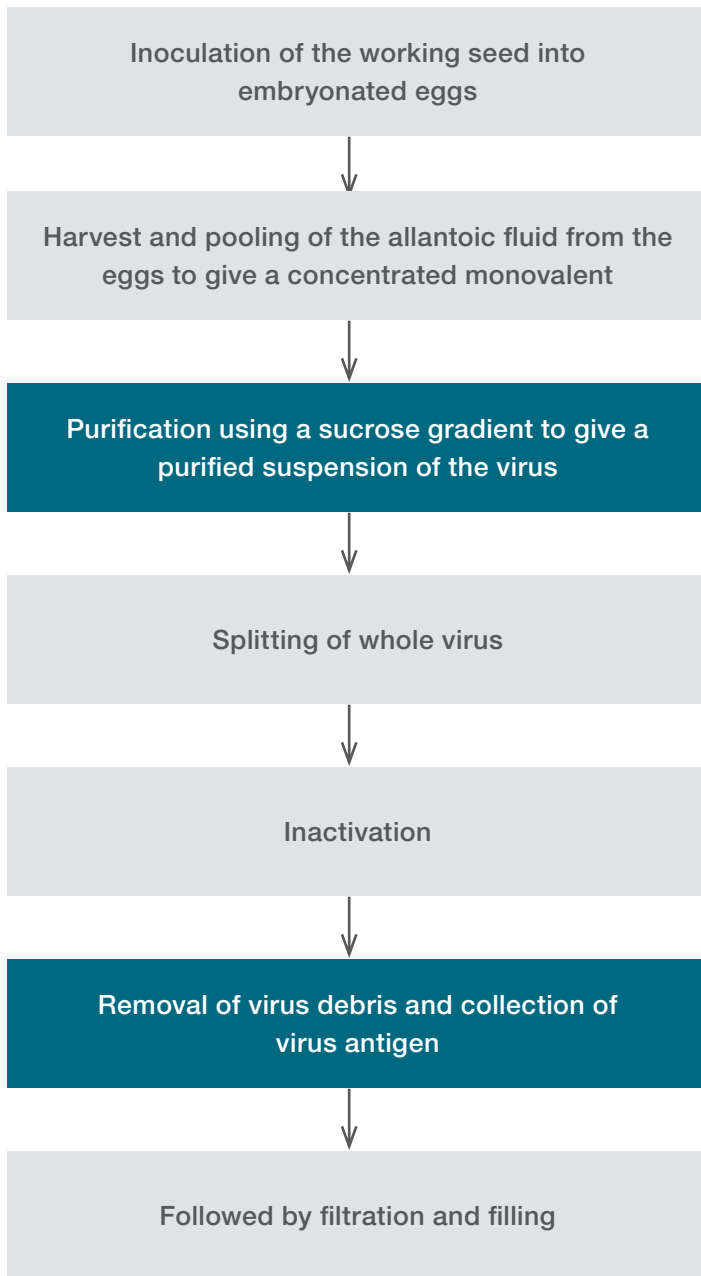

**Sorvall CC40NX  
Rotor C40CT31  
Core (D2), 3.2 L**

**200 L density  
gradient separation**

A density gradient is loaded into the rotor, and the rotor is accelerated to zonal speed forming the vertical gradient. The buffer is continuously flown through the ultracentrifuge during acceleration to high speed, then the product is loaded in continuous flow. Once all the product is processed, the rotor is decelerated to stop and then the fractions are analyzed. The portion containing the purified and concentrated whole virus is harvested.



**Sorvall CC40SNX  
Rotor C40CTS6  
Core (AH), 0.8 L**

**50 L pelleting separation**

The product is processed in continuous flow through the ultracentrifuge spinning at high speed. The debris pellets into the rotor and supernatant containing the antigen (haemagglutinin (Ha) and neuraminidase (Na) viral proteins) is harvested as it is the product of interest.



Figure 4. Case study on the use of the Sorvall CC40NX and the Sorvall CC40SNX ultracentrifuges at different steps of the manufacturing process of an inactivated influenza vaccine.

# Automation and process control

Your samples are critical and require a consistent, repeatable, and traceable process. When the Sorvall CC40 series ultracentrifuge is operated from the mobile IPC, the steps of rinsing, feeding, separating, harvesting the fractions, cleaning, and sanitizing according to your specific protocols are

programmed, saved, and executed in an automated mode (refer to Figure 5). Your sequences of operation are repeated without variation, helping to simplify operator training and minimize procedural errors.

When considering automation in your process, there are four critical features that you should consider:

## 1. Automated process product security

The IPC is equipped with eight safety features monitoring against out-of-limit conditions and preventing loss of product (see below and Figure 5):

1. Empty feed tank detection for pump safety stop
2. Full rotor detection for rotation safety start and overpressure flow detection
3. Thermo Scientific™ SafeStream™ technology for automatic product line backpressure adjustment for documented evidence of sample integrity
4. Emergency stop circuit with reset button
5. Visual indication of confirmation for flow path
6. Pinch valve override button
7. Automatic pause and programmable out-of-limit process alarms for abnormal condition detection
8. Visual and audible indications for process status

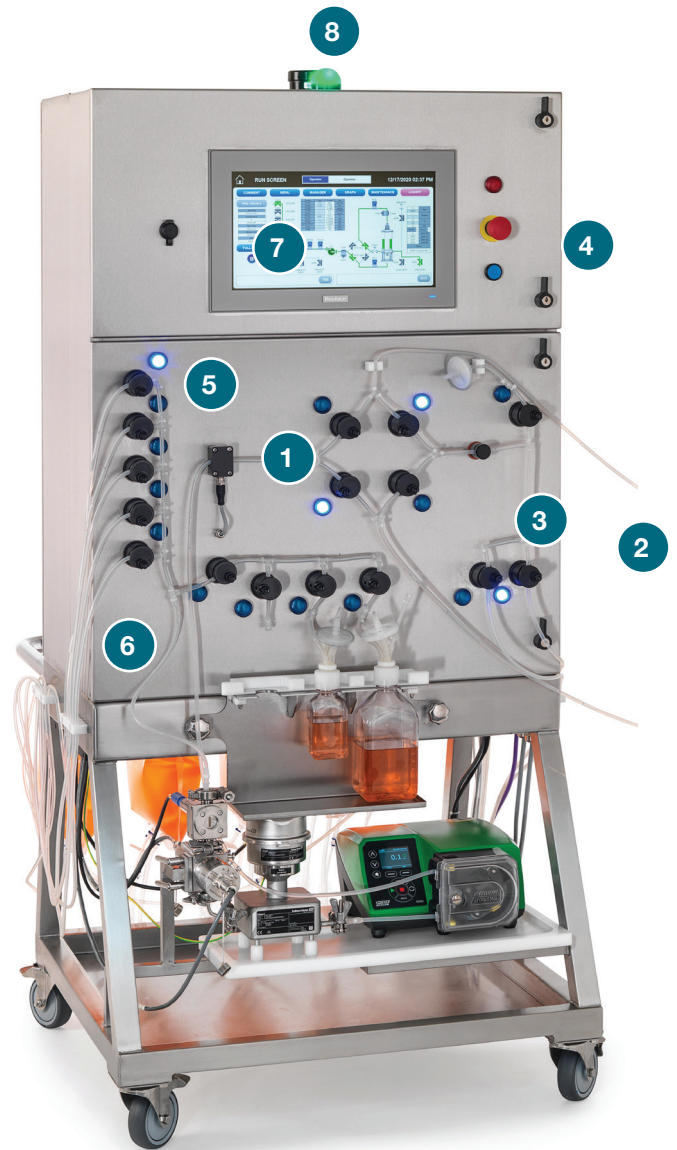

Figure 5. The IPC automates the steps of rinsing, feeding, separating, harvesting the fractions, cleaning, and sanitizing according to your specific protocols.



## 2. Automated process data security

The IPC:

- Manages remote users from a centralized Active Directory™ server
- Synchronizes time and date with the network
- Generates audit trails and batch data reports
- Communicates real-time process data with site automation system
- Integrates in-site network domain to archive files and SQL historian on shared folders for full backup

## 3. Automated process control

The IPC is equipped with fully integrated sensors to achieve high-accuracy process control (refer to Figure 6):

- |                 |                        |
|-----------------|------------------------|
| • Conductivity  | • Density              |
| • Temperature   | • Mass flow            |
| • Absorbance    | • Pressure             |
| • Concentration | • Air bubble detection |

## 4. Automated process execution

The IPC is equipped with integrated actuators to achieve automated process execution and provide flexibility in your process flow paths (refer to Figure 7):

- 16 pinch valves
- 1 proportional pinch valve
- 1 peristaltic pump

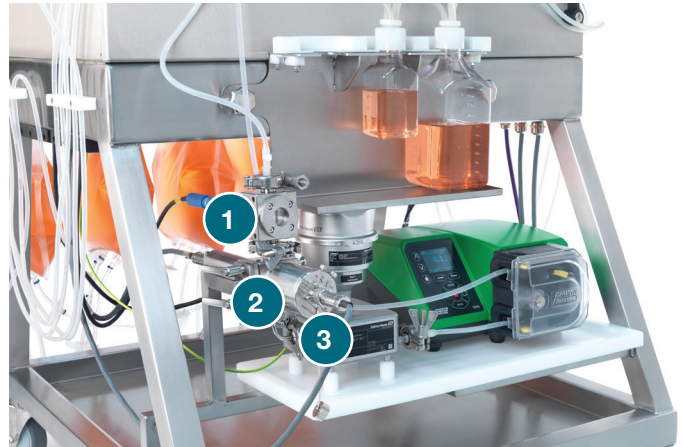

Figure 6. IPC close-up view from bottom with (1) conductivity meter, (2) spectrophotometer, (3) mass flow meter, and refractometer (not shown) to automatize the process control.

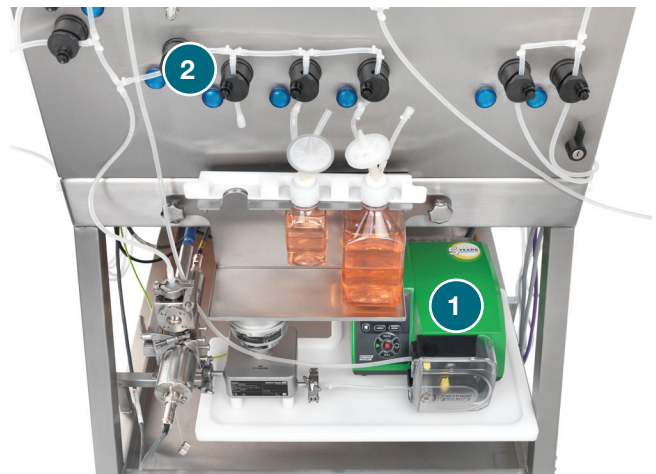

Figure 7. IPC close-up view from front with (1) pump and (2) pinch valves to automatize the process execution.

# Automation and sample integrity

Contamination of your critical sterile product is not an option. The key to achieving sample integrity is protecting the product through the product-contact path.

The Sorvall CC40 series ultracentrifuges achieve this by using industry-standard, GMP-compatible, sterilized, single-use tubing sets to connect the continuous-flow ultracentrifuge rotor core to the feed and harvest containers (refer to Figure 5 and Table 3); using our proprietary SafeStream smart technology for evidence of cross-contamination-free

conditions; and pre-/post-use steam-in-place and/or chemical decontamination/sterilization of reusable elements (refer to the “GMP-compatible” section).

SafeStream smart technology is integrated into the IPC and monitors the different pressures on the union joint seals and self-adjusts backpressure on the product line to maintain a positive set pressure cascade, see Figure 8. Because the product line is maintained at a higher pressure than the utility lines, your sample is always safe, and the evidence is documented on your batch report.

Table 3. The sterilized single-use tubing set is delivered with a certificate of compliance showing conformity to endotoxin, bioburden, and sterility acceptance criteria.

Tubing sets	Material	Size	Compliance
Tubing set A-D 1/8" x 1/4"	C-Flex™ 374 silicone	ID 1/8" OD 1/4"	USP Class VI and /or ISO-10993 EMA/410/01 and US CFR Title 9 of Part 94.18
Tubing set A-D 1/4" x 3/8"		ID 1/4" OD 3/8"	USP <85> ISO 11737 Irradiation: 25–45 kGy

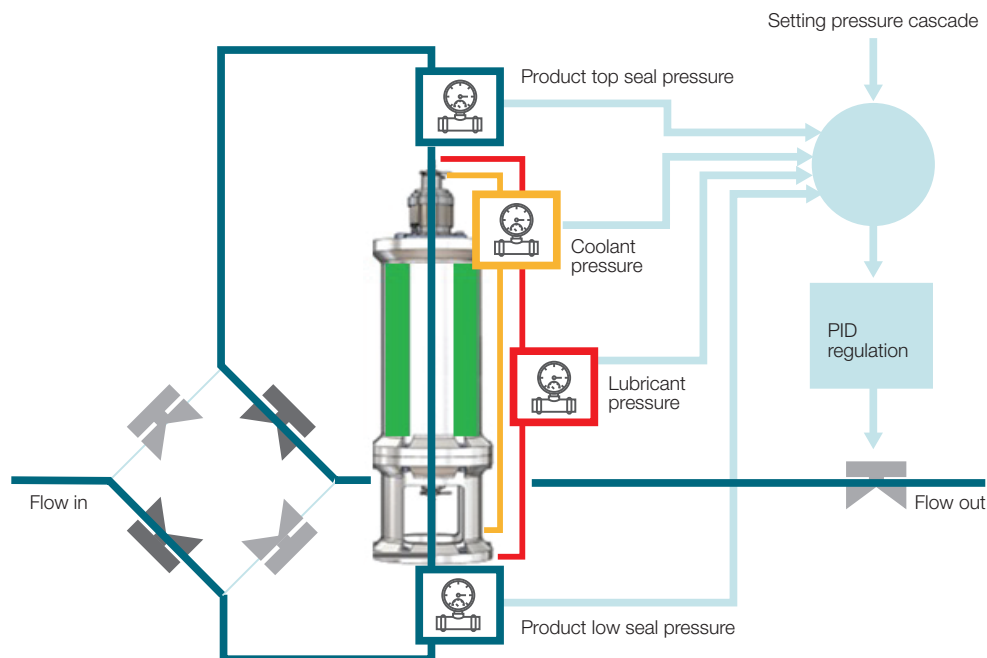

Figure 8. SafeStream smart technology with pressure cascade for documented evidence of sample integrity. The product contact path, in dark blue, is maintained at a higher pressure than the utility lines, in red and yellow, thereby ensuring that the product is free of contamination.

# GMP-compatible

**Compliance to GMP standards is critically important in the commercialization of your product—Sorvall CC40 series ultracentrifuges are GMP-compatible and will enable you to achieve compliance around three key areas:**

## 1. Connectivity

CFR 21 part 11 support with:

- Access to authorized users through login management by network Active Directory server in Figures 9 and 10
- Synchronized time and date with network server
- Collection and saving of all process data on local SQL database
- Audit trail and batch data reports
- Archives all data and reports on network

## 2. Sterility in product-contact path

Because the wetted parts are in contact with your samples and cleaning and sanitization are key to batch release, the system is:

- Made of USP Class VI and FDA-approved material
- Designed with no dead leg area
- Electropolished and the surface roughness inspected
- Suitable for clean-in-place or clean-out-place methods
- Compatible with chemical and steam-in-place decontamination

## 3. Suitability for clean room usage

The Sorvall CC40 series ultracentrifuges come clean room–ready with:

- Stainless steel exterior
- Available factory modifications to reduce even particles emission by redirecting the exhaust

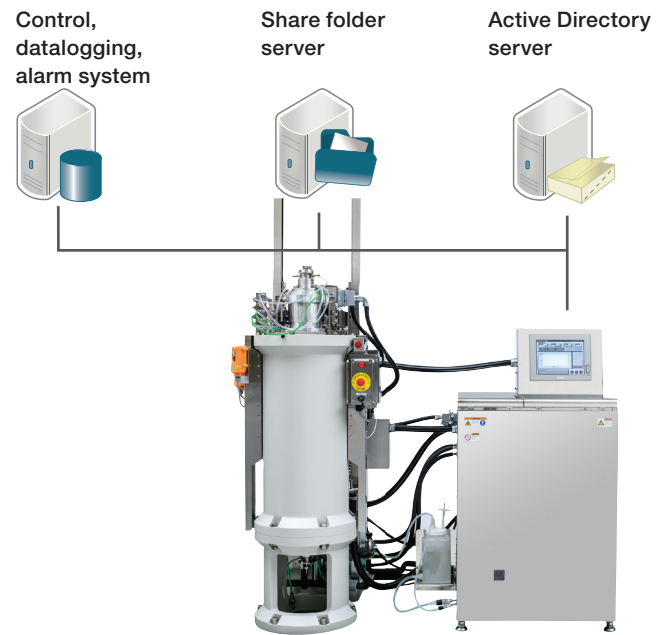

Figure 9. Connectivity of the Sorvall CC40NX ultracentrifuge.

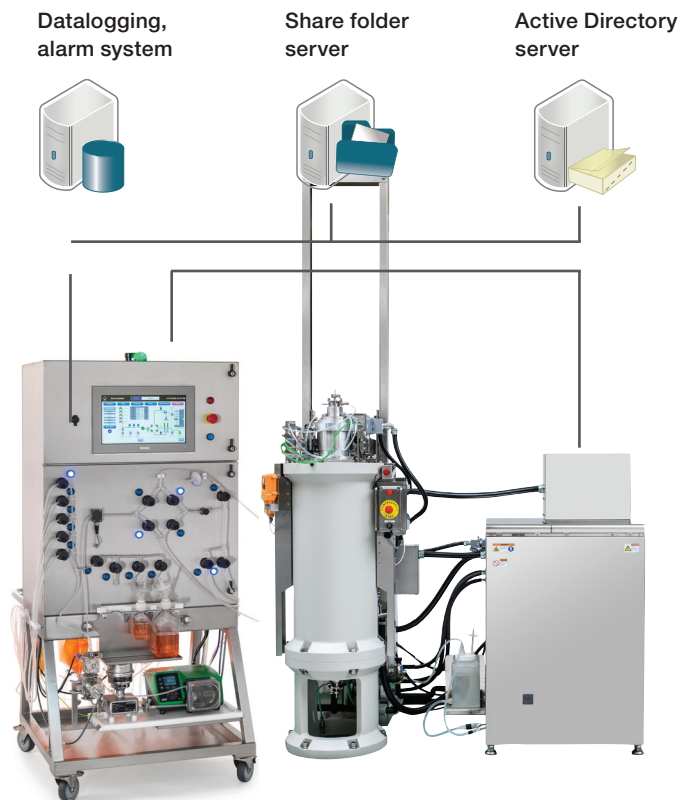

Figure 10. Connectivity of the Sorvall CC40NX ultracentrifuge with IPC.

# Reduced cost of ownership

**Total cost of ownership is an important consideration in the technology you choose. The Sorvall CC40 series ultracentrifuges reduce the total cost of ownership by reducing not only capital expenses, but also operating expenses with their innovative features.**

## Capital expense reduction

Unlike other suppliers' systems that require expensive and bulky process-compressed air, a filtration exhaust system, and a cooling water loop, the Sorvall CC40 series ultracentrifuges come with an efficient electrical drive and integrated chiller system, reducing capital expense for floor space to a minimum (refer to Figure 11 and Table 4).



**Main electrical power**  
208, 220, 230, 240 VAC  
Single phase  
50/60 Hz  
30 A



Figure 11. The Sorvall CC40 series ultracentrifuges come with an efficient electrical drive that eliminates the need for external utilities such as compressed air.

## Operating expense reduction

The Sorvall CC40 series ultracentrifuge comes equipped with innovative features that track and monitor parts utilization and enable you to undergo preventative maintenance versus incur costly down times with unexpected failures (refer to Table 4). Moreover, the electrical drive system (refer to Figure 12) is highly reliable and has been industry tested for over 30 years, it also comes with an optional warranty extension program that provides you with peace of mind.

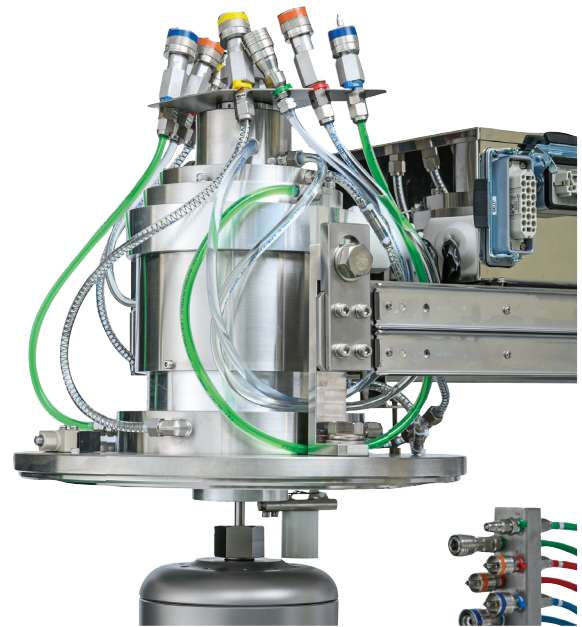

Figure 12. Highly reliable electrical drive system.

**Table 4. The capital and operating expense cost-reduction features from Sorvall CC40 series ultracentrifuges.**

Cost-reduction features for capital expenses	Cost-reduction features for operating expenses
✓ No requirement for pharma-grade main compressed air utility	✓ Consumable parts usage tracking management
✓ No requirement for pharma-grade backup compressed air utility	✓ Rotor and core lifetime tracking management
✓ No requirement for exhaust air treatment utility	✓ Electrical drive highly reliable
✓ No requirement for cooling water loop utility	✓ Electrical drive overhaul program
✓ No requirement for noise reduction infrastructure	



# Minimized time to commercialization and maximized uptime

**Minimizing time to commercialization and maximizing machine uptime are critical to your success. We offer industry-leading capability services.**

## **Minimizing time to commercialization**

It all starts with one key contact person to manage your project execution from start to finish. The PMP™-certified project manager single point-of-contact ensures your success in minimizing time to commercialization by:

- Executing the design qualification against your requirement specifications
- Tracking progress of manufacturing and sending reports
- Conducting factory acceptance test
- Preparing GMP turnover package documentation
- Inspecting the installation site prior to delivery
- Coordinating shipping, moving, rigging, and setting in place
- Training the local service engineer executing the installation, test run, and commissioning
- Executing the installation and operation qualification for final approval

## **Maximized uptime**

A range of plans and warranties and our local service capabilities ensure that your uptime is maximized by:

- Our wide-ranging offering of plans and warranties to ensure that you get the support you need and want
- Service plan customers get priority access to our original equipment manufacturer (OEM) trained and certified technical specialists
- For repairs requiring on-site corrective services, we offer faster varied response targets to meet your unique needs
- More than 1,000 service engineers with global coverage—engineers receive factory training and mentorship, as well as periodic evaluation, and regional centers keep spare parts available for user's requirements
- And a wide range of after-installation options, including periodic maintenance, trainings, calibration services, and more

# Specifications

## Sorvall CC40NX ultracentrifuge rotor and core specifications

Description							
Rotor model	C40CT31					C40CT41 (high flow) <sup>1</sup>	
Cat. No. for painted CIP-type (with aluminium travel box)	902017D3					90201813	
Cat. No. for non-painted CIP-type (with aluminium travel box)	902017D6					90201816	
Core type	Core (D2) Ti-Core (D2) <sup>2</sup>	Core (F)	Core (G)	Core (E)	Ti-Core (G) <sup>3</sup>	Core (H) <sup>4</sup> Ti rCore (H) <sup>5</sup>	Core (GH)
Cat. No. (with aluminium travel box)	S204856C 91202012	S201219D	S201221C	S301860D	S204477C	S203341D 91202110	S204639D
Max speed	40,000 rpm			36,000 rpm	35,000 rpm	40,000 rpm	
RCF at Rmax	118,000 x g			96,000 x g	90,400 x g	118,000 x g	
Rmax	66 mm					66 mm	
Core length	761 mm					761 mm	
Rotor weight	31 kg					31 kg	
Rotor material	Titanium alloy					Titanium alloy	
O-ring material	FKM*					FKM*	
Process flow rate and pressures	1.5 bar max (Up to 90 L/Hr when loading)					1.5 bar max (Up to 90 L/Hr when loading)	
Rmin	54.5 mm	26.6 mm	21 mm	26.6 mm	54.5 mm	26.6 mm	
RCF at Rmin	97,500 x g	47,600 x g	30,400 x g	36,400 x g	97,500 x g	36,400 x g	
Capacity	3.2 L	3.2 L + 0.3 L <sup>6</sup>	7.7 L	8.0 L	7.7 L	3.2 L	7.7 L
Core material	NORYL resin Titanium	NORYL resin			Titanium	NORYL Titanium	NORYL resin

1. The C40CT41 rotor, using Core (H) and Ti-Core (H), is designed with 30% lower flow restriction compared to the C40CT31 rotor, which allows for a higher flow rate for viscous samples.

2. The shape and size of Ti-Core (D2) are the same as Core (D2).

3. The shape and size of Ti-Core (G) are the same as Core (G). C40CT31 rotor and Ti-Core (G) are factory set matched.

4. Core (H) NORYL resin for C40CT41 rotor also available in 0.2 L (S206310B), 0.4 L (S206311B), 0.8 L (S102534B) and 1.6 L (S206312B) volume (max 35,000 rpm).

5. The shape and size of Ti-Core (H) are the same as Core (H).

6. A pre-clarifier adds the indicated 0.3 L.

\* FKM: Fluoroelastomer rubber, USP Class VI-compliant.

## Sorvall CC40SNX ultracentrifuge rotor and core specifications

Description					
Rotor model	C40CTS5			C40CTS6 (high flow) <sup>7</sup>	
Cat. No. for painted CIP-type (with aluminium travel box)	902023D3			90202413	
Cat. No. for non-painted CIP-type (with aluminium travel box)	902023D6			90202416	
Core type	Core (A)	Ti-Core (A) <sup>8</sup>	Core (B)	Core (AH) <sup>9</sup>	Ti-Core (AH) <sup>10</sup>
Cat. No. for (with aluminium travel box)	S200332C	S204334C	S200335C	S204092C	S204335C
Max speed	40,000 rpm			40,000 rpm	
RCF at Rmax	118,000 x g			118,000 x g	
Rmax	66 mm			66 mm	
Core length	382 mm			382 mm	
Rotor weight	15 kg			15 kg	
Rotor material	Titanium alloy			Titanium alloy	
O-ring material	FKM*			FKM*	
Process flow rate and pressures	1.5 bar max (Up to 90 L/Hr when loading)			1.5 bar max (Up to 90 L/Hr when loading)	
Rmin	54.5 mm			54.5 mm	
RCF at Rmin	97,500 x g			97,500 x g	
Capacity	1.6 L		1.6 L + 0.15 L <sup>11</sup>	1.6 L	
Core material	NORYL resin	Titanium	NORYL resin	NORYL resin	Titanium

7. The C40CTS6 rotor, using Core (AH) and Ti-Core (AH), is designed with 30% lower flow restriction compared to the C40CTS5 rotor, which allows for a higher flow rate for viscous samples.

8. The shape and size of Ti-Core (A) are the same as Core (A).

9. Core (AH) NORYL resin for C40CTS6 rotor also available in 0.2 L (S205728B), 0.4 L (S205729B) and 0.8 L (S206309B) volume (max 35,000 rpm).

10. The shape and size of Ti-Core (AH) are the same as Core (AH).

11. A pre-clarifier adds the indicated 0.15 L.

\* FKM: Fluoroelastomer rubber, USP Class VI-compliant.

# Specifications

## Specifications

Model	Sorvall CC40NX ultracentrifuge	Sorvall CC40SNX ultracentrifuge
Cat. No.	901206S1	901207S1
Max speed; Max RCF	40,000 rpm; 118,000 x g	
Max process flow and pressure	Up to 90 L/h @ 1.5 bar	
Speed setting	From 1,000 rpm to 40,000 rpm (100 rpm inc.)	
Temperature setting	from 0.0°C to 40.0°C (0.1°C inc.)	
Timer setting range	From 1 min to 99 hr 59 min (including HOLD)	
Vacuum system	Oil rotary vacuum pump	
Drive system	Electric induction motor (direct-coupled)	
Control system	Microcomputer control	
Control panel specification	Color, touch-sensitive LCD panel, HMI, Windows™ 10 OS	
Noise level	68 dB	
Cooling system	Integrated refrigerator (R513A)*	
Process connections	1/2 in. sanitary tri-clamp	
Sample contact material	SUS630, FKM O-rings, Rulon™ 641 face seals, titanium alloy, SUS316L, PTFE, silicone gasket	
Lubricants	General and H1 FDA oil	
Dimensions W x D x H	1,750 x 1,150 x 2,950 mm Height to top of the controller: 1,450 mm	1,750 x 1,150 x 2,160 mm Height to top of the controller: 1,450 mm
Weight	990 kg	860 kg
Power	AC 200, 208, 220, 230, 240 V +/- 10%, Single phase, 30A, 50/60 Hz	

Model	IPC for tube 1/8" x 1/4"	IPC for tube 1/4" x 3/8"
Cat. No.	SLZ063128 SLZ063594	SLZ065349 SLZ065350
Min-max process flow	20–400 mL/min	80–1,600 mL/min
Control panel specifications	Color, touch-sensitive LCD panel, HMI, Windows 10 OS	
Process connections	1/2 in. sanitary tri-clamp	
Sample contact material	SUS 316L, URANUS B6 steel	
Dimensions W x D x H	800 x 800 x 1,700 mm	
Weight	200 kg	
MAIN power	AC 100–240 V +/- 10%, single phase, 15 A, 50/60 Hz	
UPS power	AC 100–240 V +/- 10%, single phase, 15 A, 50/60 Hz	

\*This product complies with F-Gas REGULATION (EU) No 517/2014. It contains fluorinated greenhouse gases in a hermetically sealed system. See Technical Data Sheet for full details.



# Ordering information

Description	Cat. No.
<b>Ultracentrifuges</b>	
Sorvall CC40NX ultracentrifuge, standard machine	901206S1
Sorvall CC40SNX ultracentrifuge, standard machine	901207S1
<b>Accessories</b>	
Tool kit with SST hand press	S205021H
Template A in black painted steel	S409417A
Template B in stainless steel	S409417B
Rotor cart for CC40NX	S205710B
Rotor cart for CC40SNX	S102222A
Factory Acceptance Test (FAT)	S308110
cGMP document	S308048
<b>Modification (factory installed)</b>	
Control unit, right-hand side-facing position	S312068A
Control unit, left-hand front-facing position	S312069A
Control unit, left-hand side-facing position	S312082A
Analog outputs and alarm relay contact	S312070A
Power cable for UPS	S312071A
Brake resistor remote	S312072A
Vacuum pump exhaust remote	S312073A
FSCL phenol and hot water-compatible	S312074A
FSCL automatic sanitization system	S312075A
LSOL phenol-compatible	S312076A
Tag medal in stainless steel	S312077A
Main unit in stainless steel	S312078A
HEPA filter	S312079A
FDA food-grade oil	20270170
<b>Modification (field installed)</b>	
Connecting piece for upper shaft CIP	S308475A
Connecting piece for upper and lower shafts CIP	On request
HMI masked cover, removable	S312080A
Buffer tank for batch-mode operation	S312081A
Aluminium travel case, C40NX rotor	S205714
Aluminium travel case, C40NX core	S2057142
Aluminium travel case, C40SNX rotor	S206279
Aluminium travel case, C40SNX core	S2062792
<b>Modification (other)</b>	
Other modification	On request
<b>Services</b>	
Shipment	On request
Installation, Site Acceptance Test (SAT), user training	On request
IQ/OQ service	On request
Service training	On request

## Ordering information

Description	Cat. No.
<b>IPC standard machine</b>	
IPC standard machine left hand for tube 1/8" x 1/4"	SLZ063128
IPC standard machine left hand for tube 1/4" x 3/8"	SLZ065349
IPC mirror machine right hand for tube 1/8" x 1/4"	SLZ063594
IPC mirror machine right hand for tube 1/4" x 3/8"	SLZ065350
<b>Accessories</b>	
Tubing set A 1/8" x 1/4"	SUT12125
Tubing set B 1/8" x 1/4"	SUT12126
Tubing set C 1/8" x 1/4"	SUT12127
Tubing set D 1/8" x 1/4"	SUT12128
Tubing set A 1/4" x 3/8"	SUT12120
Tubing set B 1/4" x 3/8"	SUT12123
Tubing set C 1/4" x 3/8"	SUT12119
Tubing set D 1/4" x 3/8"	SUT12124
Cap 38-430 assembly for tube 1/8" x 1/4"	SUT12129
Cap 38-430 assembly for tube 1/4" x 3/8"	SUT12122
Cap 53B assembly for tube 1/4" x 3/8"	SUT12121
Cap 83B assembly for tube 1/4" x 3/8"	SUT12118
<b>Modification (factory installed)</b>	
Harvest bottle holder	SLZ064489
Feed in/out bag holder type 2	SLZ066723
Refractometer instrument	SLZ063593
Spectrophotometer instrument (WL = 254/280 nm, OP = 2 mm)	SLZ063129
Spectrophotometer instrument (WL = 254/280 nm, OP = 5 mm)	SLZ065351
Spectrophotometer instrument (WL = 280/313 nm, OP = 2 mm)	SLZ065352
Spectrophotometer instrument (WL = 280/313 nm, OP = 5 mm)	SLZ065353
Keyboard and barcode reader	SLZ067421

Find out more at [thermofisher.com/cc40](https://thermofisher.com/cc40)