



Orion Versa Star Pro Electrochemistry Meters

User Manual

68X000791 Revision B • May 2018

Table of Contents

Chapter 1	6
Meter Introduction	6
Meter Overview.....	6
Packing List	7
Intended Use	7
Chapter 2	8
Meter Basics	8
Using the Universal Power Adapter	8
Attaching the Electrode Stand	9
Meter Connections.....	10
Meter Keypad	11
Function Keys	12
Numeric Keypad.....	12
Measurement Modules	13
Module Measurement Capabilities	13
Preconfigured Meter and Module Options.....	13
Inserting and Removing Modules.....	14
Module Removal	14
Module Connections.....	15
Measurement Display Options.....	16
Single, Dual or Multiple Channel Displays.....	16
Measurement Display Examples.....	18
Additional Measurement Display Icons	19
pH Electrode Condition Icon.....	20
Customizing the Display.....	21
Meter and Module Maintenance	21
Chapter 3	22
Meter Setup Menus	22
Main Setup Menu.....	22
Channel 1-4 Setup Menus	24
Method Menu	26
Mode Menu	28
Temperature Menu.....	29
Instrument Settings Setup Menu.....	32
Log View Menu	34
Data Log.....	34
Calibration Log.....	35
Diagnostics Menu	36
System Access Menu	37
Enabling the System Access Feature	38
Logging into the Administrator Account.....	42
Logging into Existing User Account.....	43
Logging Out of Existing User Account.....	43
Chapter 4	44
pH, pH/ISE and pH/LogR Measurement Modules	44

Connecting Electrodes to the Module	44
Channel 1-4 Setup Menus	47
Mode Menus for pH, mV, Relative mV, ORP and ISE.....	47
pH Calibration	52
pH Calibration Editing.....	52
Relative mV Calibration	54
ORP Calibration.....	55
ISE Calibration (pH/ISE Module Only).....	56
ISE Calibration Editing	56
Temperature Calibration	57
ATC Probe Temperature Calibration	57
Manual Temperature Entry.....	58
LogR Temperature Calibration (pH/LogR Module Only)	59
Incremental Techniques (pH/ISE Module Only).....	61
Single Known Addition	62
Double Known Addition	64
Single Known Subtraction	66
Double Known Subtraction.....	68
Single Analate Addition	70
Single Analate Subtraction	72
Chapter 5.....	74
Conductivity Measurement Module	74
Connecting Electrodes to the Module	74
Channel 1-4 Setup Menus	75
Mode Menus for Conductivity, TDS, Salinity and Resistivity	75
Conductivity Calibration	80
Automatic or Direct Conductivity Calibration	80
Cell Constant Entry (Manual Conductivity Calibration).....	82
Conductivity Verification Procedure	83
Chapter 6.....	84
RDO/DO Measurement Module.....	84
Connecting Electrodes to the Module	84
Channel 1-4 Setup Menus	85
Mode Menus for Dissolved Oxygen	85
RDO Electrode Information	86
Dissolved Oxygen Calibration.....	87
Water Saturated Air Calibration.....	87
Air Saturated Water Calibration.....	88
Manual (Winkler) Calibration	88
Set Zero Calibration	89
Chapter 7	90
Meter Measurements	90
Measurement Overview	90
Measurement Read Types	92
Auto-Read	92
Timed	92
Single-Shot.....	93
Continuous	93
Measurement Procedure	94

Measurement Tip – Using the Electrode Holder.....	95
Chapter 8.....	96
Data Transfer and Software Updates	96
Data Transfer Settings.....	96
Installing the Versa Star USB Driver Software.....	98
Meter Software Upgrade Procedure	99
Computer and Printer Compatibility	101
Computer Requirements	101
Printer Requirements	101
Versa Star Pro Meter Remote Control Protocols	102
Remote Control Commands.....	102
Chapter 9.....	112
Customer Services	112
Troubleshooting Tips	113
Meter Self-Test.....	114
WEEE Compliance	115
Declaration of Conformity	115
Meter Specifications	116
Ordering Information.....	122
Versa Star Pro Meters and Versa Star Modules	122
Versa Star Pro Meter Accessories, Electrodes and Solutions.....	126
Appendix A.....	128
Channel Specific Settings and Features	128
General Mode Settings	128
Sample ID	128
Stability.....	129
Averaging	129
Alarms	129
pH and ISE Mode Settings	130
Buffer Group and Automatic Buffer Recognition	130
Isopotential Value.....	131
Linear Regression	132
Blank Correction.....	133
Low Level Stability	134
LogR Temperature Technology	135
LogR Temperature Accuracy	135
Advanced pH Electrode Diagnostics using LogR Technology	136
Conductivity, TDS, Salinity and Resistivity Mode Settings.....	140
Cell Constant (K) and Automatic Conductivity Calibration	140
Orion Conductivity Standard Values from 0 °C to 50 °C.....	141
Reference Temperature, Temperature Compensation and Temperature Coefficient	143
Cell Type	144
TDS Factor.....	144
Salinity Type.....	144
Dissolved Oxygen Settings.....	145
Barometric Pressure Compensation	145
Salinity Correction	145

1

Chapter 1 **Meter Introduction**

Meter Overview

Thermo Scientific™ Orion™ Versa Star Pro™ meters offer four channels that can be configured in any combination through their modular design. Measurement modules are automatically recognized by the meter and can be added or removed from channels at any time.

Five Thermo Scientific™ Orion™ Versa Star™ measurement modules are available:

- VSTAR-PH module measures pH, mV, relative mV or ORP with temperature
- VSTAR-ISE module measures concentration using an ion selective electrode (ISE), pH, mV, relative mV or ORP with temperature
- VSTAR-LR module measures pH, mV or ORP with temperature, including LogR technology that measures sample temperature using a glass-bulb pH electrode – no separate ATC probe needed in samples
- VSTAR-CND module measures conductivity, TDS, salinity or resistivity with temperature
- VSTAR-RD module measures dissolved oxygen as percent saturation or concentration with temperature using either RDO® optical or polarographic probes

Orion Versa Star Pro meters offer a System Access feature for administrative and up to ten user accounts with custom access to various meter functions including data/time settings, meter setup, measurement setup, data log and calibration log. Use password protection to secure selected meter functions while leaving other functions accessible for all users – the new System Access feature allows you to customize meter access to meet your specific security and data

reporting needs. The system access feature can easily be turned on or off as the needs of your lab change for the ultimate flexibility in operation and ease-of-use.

Get the information you need quickly and easily from the large, bright color display, which can be personalized to show only the measurements and information you need. Display one to four measurements simultaneously in any combination.

When setting up the meter or performing a calibration, step-by-step instruction prompts and a numeric keypad with menu-specific function keys make meter operation fast and simple. The meter interface can be set to a variety of languages.

Packing List

Versa Star Pro meters and meter kits include the following items:

- Meter-attachable electrode stand
- Universal power adapter, 100-240 VAC, 50-60 Hz
- Literature CD
- Printed quick start guide
- USB computer cable
- Meter test certificate

Each Versa Star Pro meter is tested and certified by Thermo Fisher Scientific and a certificate of testing is included with each meter and measurement module system.

For specific measurement module and kit contents, refer to the [Ordering Information](#) section.

Visit our website at www.thermofisher.com/orionsoftware to download the latest Versa Star USB driver.

Intended Use

Please read this user manual thoroughly. Any use outside of these instructions may invalidate the meter warranty and cause permanent damage to the meter.

2

Chapter 2 **Meter Basics**

Using the Universal Power Adapter

A universal power adapter (Catalog Number STARA-PWR) with US, EU, UK and China plug plates is included with the Versa Star Pro meter.

This universal power adapter is specifically for use with Versa Star Pro meters. Use of other power adapters can damage the meter and void the warranty. The use of a surge protector or uninterruptible power supply (UPS) is also recommended.



1. Select the appropriate plug plate for the power outlet.
2. Remove the clear plastic cover from the back of the power adapter.
3. Slide the plug plate into the groove on the back of the power adapter.
4. Connect the assembled power adapter to the outlet and meter input labeled POWER.

Attaching the Electrode Stand

The electrode stand can be attached to either side of the meter and up to two stands can be attached to each meter. A weighted base (Catalog Number STARA-HB) is also available to support the stand without a meter.

1. Open the box containing the stand. Included are base plate, electrode arm, pivot pin, electrode holder, ATC spacer and RDO clip.
2. Turn the meter over, with the meter display facing down, on a clean dry surface.
3. Identify the side of the meter that the stand will be installed on and remove the screw between the circles on that side of the meter.
4. Align the base plate of the stand with the circles on the meter.
5. Replace the screw from step 3 to attach the base plate to the meter.
6. Turn the meter over, with the meter display facing up.
7. Insert the electrode arm into the metal post on the base plate.
8. Connect the electrode holder to the electrode arm using the pivot pin.
9. Once the stand has been assembled, use the two wing nuts to adjust the tension at each joint to restrict the movement forward and backward using the lower wing nut and upward and downward using the upper wing nut.

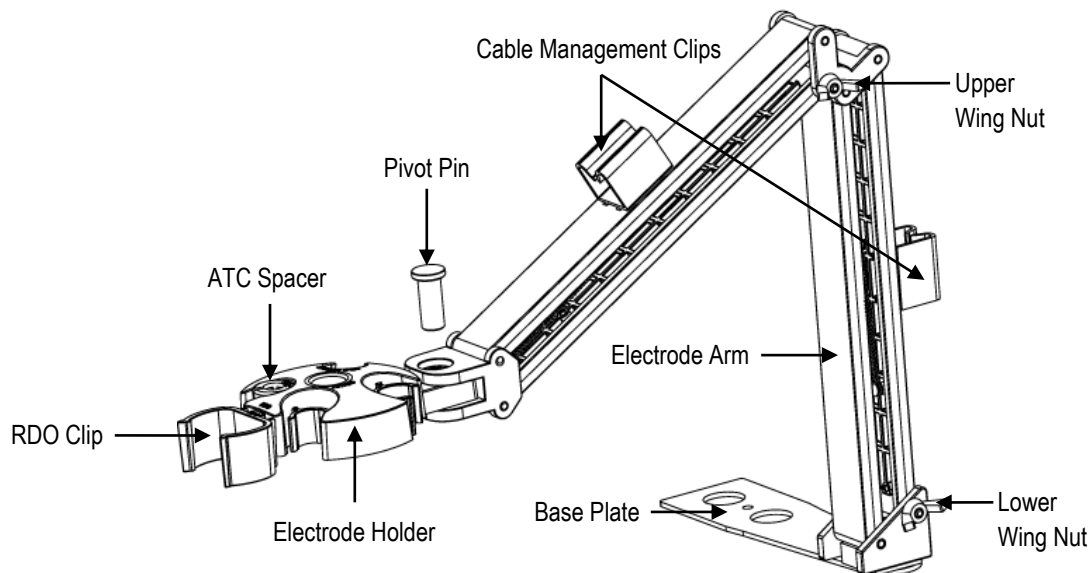

Meter Connections

1. Connect a Thermo Scientific™ Orion Star™ series stirrer probe (Cat. No. 096019) to the STIRRER 1 and/or STIRRER 2 input on the meter. The stirrer probes are controlled and powered by the meter, eliminating the need for magnetic stir bars and plates.
 - The STIRRER 1 and STIRRER 2 inputs can be assigned to each channel and the stirrer speed can be set using the [Instrument Settings](#) setup menu.
2. For data transfer to a computer, connect a cable to the MINI B USB or RS232 input on the meter and the corresponding input on the computer.
3. For data transfer to a printer, connect a cable to the MICRO AB USB or RS232 input on the meter and the corresponding input on the printer.
4. Review the meter output settings (Communication, Printing, Printing Format) in the [Instrument Settings](#) setup menu to ensure the meter output settings are correct to interface the meter with a printer or computer.

The following image shows the meter back panel without any modules connected.

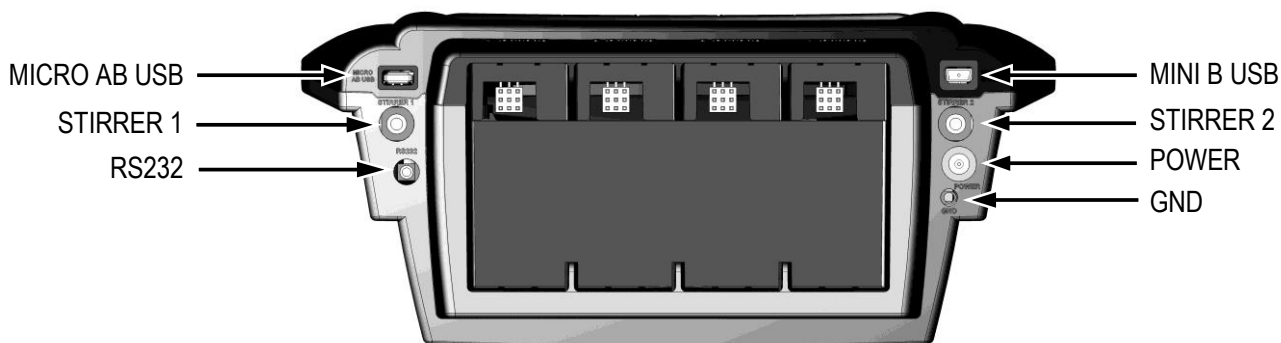







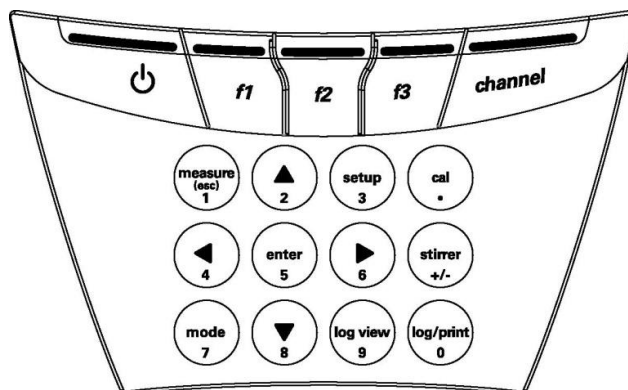

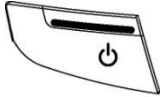
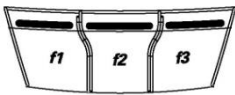
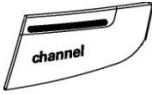



Connector	Function
MICRO AB USB	Use for data output to a USB printer
STIRRER 1	Accepts an Orion Star stirrer probe, which is controlled and powered by the meter
RS232	Use the RS232 cable (Cat. No. 1010053) for bi-directional communication and data transfer via RS232
MINI B USB	Use the USB cable (included with meter) for bi-directional communication and data transfer via USB
STIRRER 2	Accepts the Orion Star stirrer probe, which is controlled and powered by the meter
POWER	Connect the universal power adapter (included with meter) to power the meter. Remove and reconnect the power adapter to reboot the meter
GND	Ground receptacle used to reduce interference generated by other equipment

Meter Keypad

The Versa Star Pro meter keypad includes menu-specific function keys that update on the display for fast and efficient meter operation, a numeric keypad to facilitate data entry and shortcut keys for easy navigation to the measurement, setup, calibration, data log and calibration log menus.



Key Icon and Name	Function
 power	Press the power key to enter the standby meter mode with screen saver. Press the power key a second time to enter the active meter mode.
 f1, f2, f3	Press the f1 , f2 and f3 function keys to perform the action shown above each key on the display.
 channel	Press the channel key when two or more modules are connected to the meter to change the measurement display to show each channel individually or a combination of two or more channels simultaneously.
 measure (esc)	Press the measure (esc) key to start a new measurement when in the measurement mode and using Auto-Read or Single-Shot read types. Press the measure (esc) key to escape from other menus and modes to the measurement mode. Press to enter a value of one (1) when using the numeric keypad.
 up arrow (▲)	Press the up arrow (▲) key to scroll up through a list of items. Press to enter a value of two (2) when using the numeric keypad.
 setup	Press the setup key to enter the setup menu from the measurement mode. Press to enter a value of three (3) when using the numeric keypad.
 cal	Press the cal key to enter the calibration menu from the measurement mode. Press to enter a decimal point (.) when using the numeric keypad.

Key Icon and Name	Function
 left arrow (◀)	Press the left arrow (◀) key to scroll left through a list of items. Press to enter a value of four (4) when using the numeric keypad.
 enter	Press the enter key to select an option. Press to enter a value of five (5) when using the numeric keypad.
 right arrow (▶)	Press the right arrow (▶) key to scroll right through a list of items. Press to enter a value of six (6) when using the numeric keypad.
 stirrer	Press the stirrer key to turn on or off the stirrer probe when in the measurement mode and using continuous or timed read types and in the calibration edit mode. Press to make value positive or negative (+/-) when using the numeric keypad.
 mode	Press the mode key to change the measure mode of a channel. Press to enter a value of seven (7) when using the numeric keypad.
 down arrow (▼)	Press the down arrow (▼) key to scroll down through a list of items. Press to enter a value of eight (8) when using the numeric keypad.
 log view	Press the log view key to access the data log and calibration log from the measurement mode. Press to enter a value of nine (9) when using the numeric keypad.
 log/print	Press the log/print key to manually log, print, or log and print a measurement, depending on the selected read type and data output settings. Press to enter a value of zero (0) when using the numeric keypad.

Function Keys

The following image shows the **f1**, **f2** and **f3** keys with their corresponding actions above each function key on the meter display. Pressing the **f1 (Cal)** key will prompt the meter to enter the calibration mode. Pressing the **f2 (Sample ID)** key will prompt the meter to enter the sample ID setup mode. Pressing the **f3 (Setup)** key will prompt the meter to enter the main setup menu.



Numeric Keypad

The following drawing shows the keys that are active when entering a value using the numeric keypad. The decimal (.) key and plus/minus (+/-) key are active so fractional values and positive or negative values can be entered as needed.

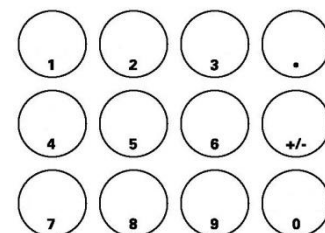

Measurement Modules

The Versa Star Pro meter has four channels that can be configured in any combination using Versa Star measurement modules. The type of module connected to the channel will define the measurement capability of that channel. Measurement modules are automatically recognized by the meter and can be added or removed from a channel at any time. Five Versa Star modules are available for pH, pH/ISE, pH/LogR, conductivity and dissolved oxygen.

Module Measurement Capabilities

The table below shows the module part number, module label shown on the top tab and measure modes. All measure modes include the option to also measure temperature.

Module Catalog #	VSTAR-PH	VSTAR-ISE	VSTAR-LR	VSTAR-CND	VSTAR-RD
Label	pH	pH/ISE	pH/LogR	Cond	RDO/DO
Measure Modes	pH mV RmV ORP	pH mV RmV ORP ISE	pH mV RmV ORP	Conductivity TDS Salinity Resistivity	% Saturation mg/L
Temperature Modes	Automatic Manual	Automatic Manual	Automatic Manual LogR	Automatic Manual	Automatic

Preconfigured Meter and Module Options

Versa Star Pro meters can be purchased without modules or preconfigured with up to four modules included. Preconfigured Versa Star Pro meters will have the modules already connected with the channels. Any open channels will be covered with blank modules.

1. VSTAR-PH (pH), VSTAR-ISE (pH/ISE), VSTAR-CND (Conductivity) and VSTAR-RD (RDO/DO) measurement modules – each connects with one channel.
2. VSTAR-LR (pH/LogR) measurement module connects with two channels.
3. Unused channels are covered with blank modules.

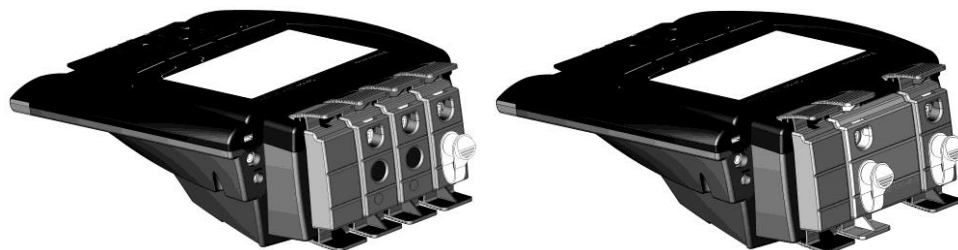

Inserting and Removing Modules

Modules can be added or removed at any time, with the meter powered on or off.

Module Insertion



1. Hold the top (labeled) and bottom tabs on the module with your thumb and index finger and squeeze the tabs towards each other.
2. Slide the module straight into an open channel groove on the back of the meter. The tabs should snap into place when the module is fully connected to the meter.
3. Release the top and bottom tabs on the module.
4. If the meter is powered on, it will automatically recognize the module and update the channel ID display (top, left) with the module ID in the corresponding channel location.

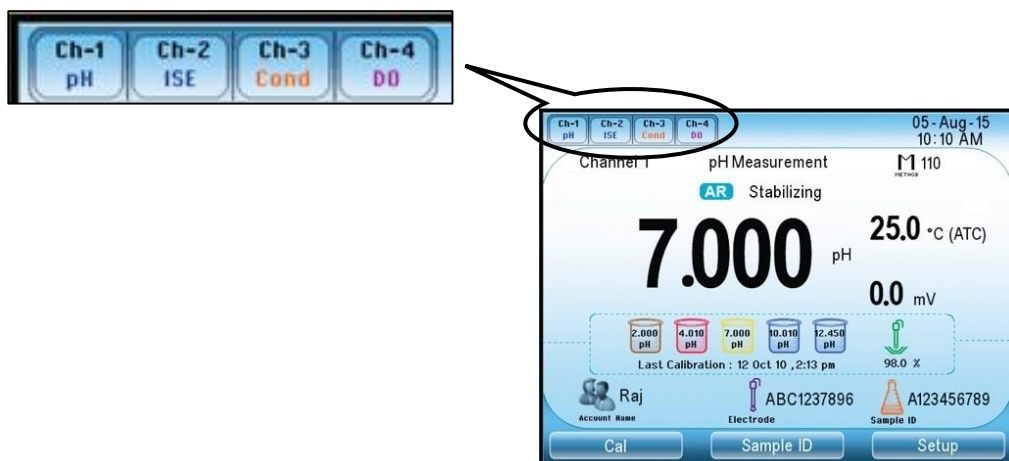

Module Removal



1. Hold the top (labeled) and bottom tabs on the module with your thumb and index finger and squeeze the tabs towards each other.
2. Pull straight back to remove the module from channel groove on the back of the meter.
3. The meter will automatically recognize that the module has been removed and update the channel ID display (top, left) with dashes in the previous channel location.

Module Connections

Versa Star Pro meters are compatible with pH electrodes with BNC connectors, ATC probes and conductivity probes with 8 pin MiniDIN connectors and dissolved oxygen probes (both RDO optical and polarographic) with 9 pin MiniDIN connectors – the same electrodes and probes compatible with Orion Star meters, Orion Star Plus meters and Orion Star A series meters.

Make sure the module is properly inserted in the meter and the meter is connected to a power source using the included universal power adapter.

Module Catalog #	VSTAR-PH	VSTAR-ISE	VSTAR-LR	VSTAR-CND	VSTAR-RD
Label	pH	pH/ISE	pH/LogR	Cond	RDO/DO
Connectors (from top to bottom)	8 pin MiniDIN	8 pin MiniDIN	8 pin MiniDIN	8 pin MiniDIN	9 pin MiniDIN
	BNC	BNC	BNC		
	Pin Tip	Pin Tip	Pin Tip		

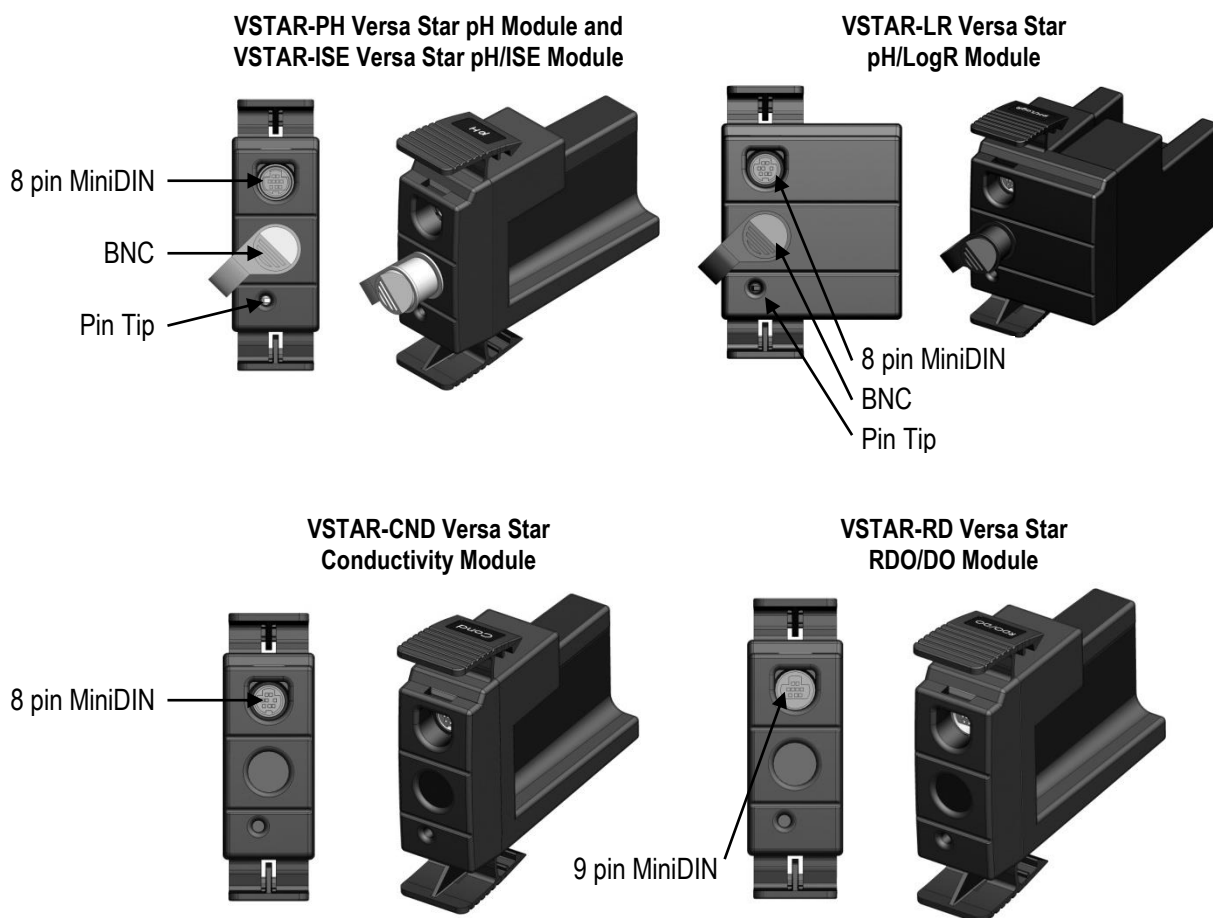

Measurement Display Options

Single, Dual or Multiple Channel Displays

When two or more modules are connected with the Versa Star Pro meter, pressing the **channel** key will change which channels are displayed in the measurement mode. Each channel can be displayed separately or two, three or four channels can be displayed simultaneously. To customize the channel display options shown when the **channel** key is pressed, use the [Instrument Settings](#) setup menu.

Press and hold the **channel** key to quickly scroll through the channel display options and release the **channel** key when the desired channel display configuration is shown. This feature is available with the latest Versa Star software and all Versa Star Pro software revisions.

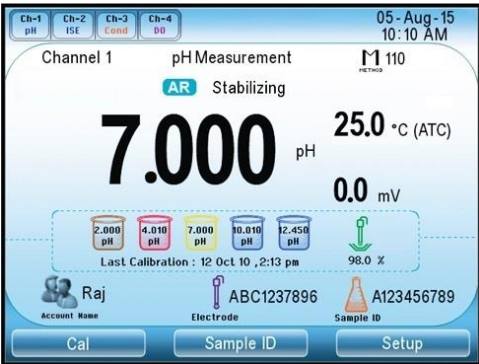
View Format	Displayed Information (Customizable & Measurement Dependent)	
Single Channel – Channel 1 – Channel 2 – Channel 3 – Channel 4	– Channel ID – Print, Log, Alarm, RS232/USB Icons – Date and Time – Channel Number – Measure Mode – Method Number – Read Type (AR, TM, SS) Icons – Stabilizing/Ready Indicator	– Main Measurement with Units – Secondary Measurement with Units – Temperature with Units and Source – Calibration Point, Data, Time, Slope – Electrode Status – RDO Cap Life – Alarm Indicators – Account ID, Electrode ID, Sample ID
Example Single Channel Display		
Two Channels – Channels 1 & 2 – Channels 1 & 3 – Channels 1 & 4 – Channels 2 & 3 – Channels 2 & 4 – Channels 3 & 4	– Channel ID – Print, Log, RS232/USB Icons – Date and Time – Channel Number – Measure Mode – Method Number	– Read Type (AR, TM, SS) Icons – Stabilizing/Ready Indicator – Main Measurement with Units – Secondary Measurement with Units – Temperature with Units and Source – Electrode ID, Sample ID

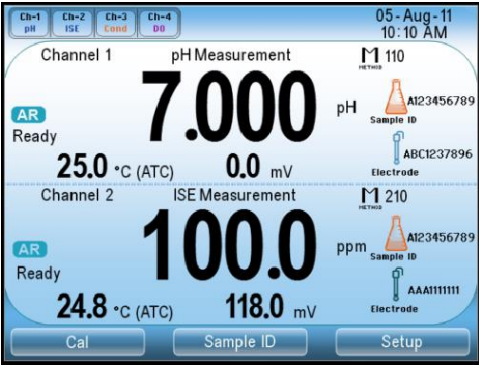
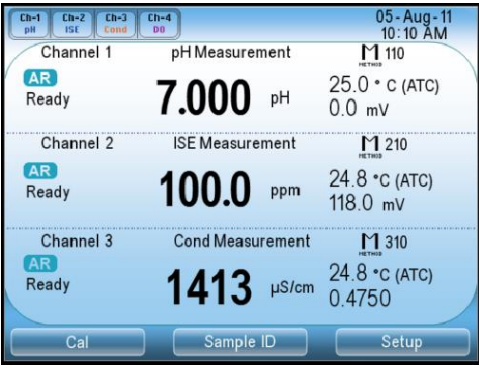
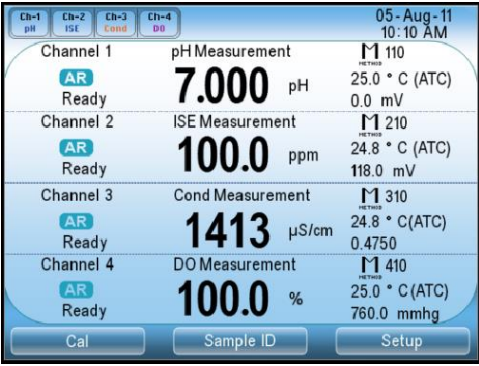
View Format	Displayed Information (Customizable & Measurement Dependent)	
<p>Example Two Channel Display</p>		
<p>Three Channels</p> <ul style="list-style-type: none"> - Channels 1, 2 & 3 - Channels 1, 2 & 4 - Channels 1, 3 & 4 - Channels 2, 3 & 4 	<ul style="list-style-type: none"> - Channel ID - Print, Log, RS232/USB Icons - Date and Time - Channel Number - Measure Mode - Method Number 	<ul style="list-style-type: none"> - Read Type (AR, TM, SS) Icons - Stabilizing/Ready Indicator - Main Measurement with Units - Secondary Measurement with Units - Temperature with Units and Source
<p>Example Three Channel Display</p>		
<p>Four Channels</p> <ul style="list-style-type: none"> - Channels 1, 2, 3 & 4 	<ul style="list-style-type: none"> - Channel ID - Print, Log, RS232/USB Icons - Date and Time - Channel Number - Measure Mode - Method Number 	<ul style="list-style-type: none"> - Read Type (AR, TM, SS) Icons - Stabilizing/Ready Indicator - Main Measurement with Units - Secondary Measurement with Units - Temperature with Units and Source
<p>Example Four Channel Display</p>		

Measurement Display Examples

pH Mode Display

Channel ID for measurement modules connected to meter →

Channel number → Channel 1

Main measurement mode → pH Measurement

Main measurement value → 7.000 pH

Calibration information with calibration points, date and time of most recent active calibration →

Date and time → 05-Aug-15 10:10 AM

Method → M110

Temperature measurement and source → 25.0 °C (ATC)

mV corresponding to main measurement → 0.0 mV

pH electrode condition icon and slope value of most recent active calibration → 98.0 %

Account Name: Raj, Electrode: ABC1237896, Sample ID: A123456789

Buttons: Cal, Sample ID, Setup

Channel 1 mV Measurement

Ready

100.0 mV

25.0 °C (ATC)

Account Name: Raj, Electrode: ABC1237896, Sample ID: A123456789

Buttons: Cal, Sample ID, Setup

mV Mode Display

Channel 1 RmV Measurement

Ready

900 mV

25.0 °C (ATC)

Offset mV : 200.0

Last Calibration : 12 Oct 10 , 2:13 pm

Account Name: Raj, Electrode: ABC1237896, Sample ID: A123456789

Buttons: Cal, Sample ID, Setup

RmV Mode Display

Channel 1 ORP Measurement

Ready

419.5 mV

25.0 °C (ATC)

Offset mV : 200.0

Last Calibration : 12 Oct 10 , 2:13 pm

Account Name: Raj, Electrode: ABC1237896, Sample ID: A123456789

Buttons: Cal, Sample ID, Setup

ORP Mode Display

ISE Mode Display

Channel ID for measurement modules connected to meter →

Channel number → Channel 1

Main measurement mode → ISE Measurement

Ion selective electrode (ISE) type → F-

Main measurement value → 100.0 ppm

Calibration information with calibration points, date and time of most recent active calibration →

Date and time → 05-Aug-11 10:10 AM

Method → M110

Temperature measurement and source → 25.0 °C (ATC)

mV corresponding to main measurement → 118.0 mV

ISE condition icon and slope value of most recent active calibration → -59.2 mV/dec

Account Name: Raj, Electrode: ABC1237896, Sample ID: A123456789

Buttons: Cal, Sample ID, Setup

pH/LogR Mode Display

Channel ID for measurement modules connected to meter →

Channel number → Channel 4

Main measurement mode → pH Measurement

Main measurement value → 10.010 pH

Temperature measurement and source → 25.1 °C (LogR)

pH bulb resistance, appears with LogR temperature compensation → Bulb Resistance : 100.0 MΩ

mV corresponding to main measurement → -178.1 mV

Date and time → 05-08-11 10:10 AM

Method → M1410

Account Name: Raj, Sample ID: XYZ123

Buttons: Cal, Sample ID, Setup

Conductivity Mode Display

Channel ID for measurement modules connected to meter →

Channel number →

Main measurement mode →

Main measurement value →

Calibration information with calibration points, date and time of most recent active calibration →

Date and time →

Method →

Temperature compensation setting →

Temperature measurement and source →

Main measurement units →

Dissolved Oxygen Mode Display

Channel ID for measurement modules connected to meter →

Channel number →

Main measurement mode →

RDO optical cap information (changes from green to red with 30 days or less of cap life) →

Main measurement value →

Date and time →

Method →

Salinity value →



Temperature measurement and source →









Main measurement units →

Barometric pressure →

Calibration information with calibration type, date and time of most recent active calibration →



Additional Measurement Display Icons

Icon	Name	Description
	Printer Icon	Signals when a measurement is sent to a printer or computer (measurement read type dependent). Printing option must be set to On in the Instrument Settings setup menu.
	Data Log Icon	Signals when a measurement is recorded in the data log (measurement read type dependent). Data log option must be set to On in the Instrument Settings setup menu.
	Alarm Icon	Shown when a meter alarm is triggered. The corresponding alarm identification will also flash on the display as High Limit Alarm , Low Limit Alarm , Cal Due Alarm or Set Point Alarm . Alarm must be enabled in the channel-specific setup menu.

Icon	Name	Description
	USB Icon	Shown when the Communication option is set to USB or USB PRINTER in the Instrument Settings setup menu.
	RS232 Icon	Shown when the Communication option is set to RS232 in the Instrument Settings setup menu.
	Auto-Read Icon	Shown when the measurement read type is set to Auto-Read. The icon flashes while the measurement value is stabilizing and remains solid when the measurement value is stable and locked on the display.
	Timed Read Icon	Shown when the measurement read type is set to Timed.
	Single-Shot Icon	Shown when the measurement read type is set to Single-Shot.
Stabilizing	Stability Indicator	Flashes while the measurement value is stabilizing.
Ready	Stability Indicator	Shown when the measurement value is stable.
	Cal Due Alarm	Flashes when the calibration due alarm is triggered. Cal Due Alarm must be enabled in the channel-specific setup menu.
	Account ID Icon	Shown with the user name logged onto the active account when the System Access feature is enabled.
	Electrode ID Icon	Shown with the electrode serial number or name entered using a channel-specific setup menu.
	Sample ID Icon	Shown with the sample name or value (auto-incremental) entered using a channel-specific setup menu or Sample ID shortcut key.

pH Electrode Condition Icon

Versa Star Pro meters with pH, pH/ISE and pH/LogR modules include a pH electrode condition icon. In the measurement mode, the electrode condition icon indicates the performance of the electrode, based on the last saved calibration and electrode measurement stability.

Icon	pH Electrode Status
	Electrode condition is good. The electrode slope is in the range of 95.1% to 104.9 %.
	Electrode condition is fair. The electrode slope is in the range of 85.1% to 95.0% or in the range of 105.0 % to 114.9%.
	Electrode condition is bad. The electrode slope is less than 85% or the electrode slope is greater than 115%. Consult the pH electrode user manual for instructions on how to clean, condition and troubleshoot the electrode.

Note: This is a general indicator of overall electrode status – always refer to the pH electrode user manual for specific information on the recommended slope range for each pH electrode.

Customizing the Display

The information shown in the measurement mode can be customized. Reducing the information will increase the font size of the main measurement value in the single channel display.

1. In the measurement mode, press the **setup** key.
2. Press the ▲, ▼, ◀ or ▶ key until Instrument Settings is highlighted and press the **f3 (Select)** key.
3. The Display setting will be highlighted in the left column. Press the ▶ key to also highlight Display View and press the **f3 (Select)** key.
4. Press the ▲ or ▼ key to highlight an item and press the **f3 (Select)** key to check (display) or uncheck (hide) the item. Some items will only be shown in the single channel display when checked.
5. Press the **f1 (Done)** key and then press the **measure (esc)** key to return to the measurement mode.

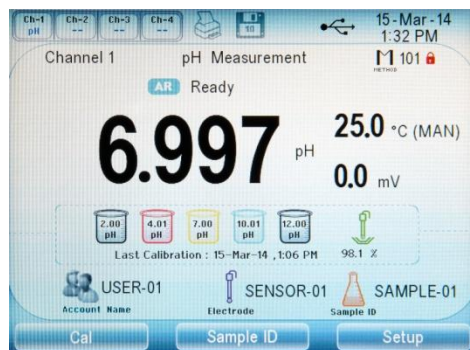

Example measurement display with all information shown

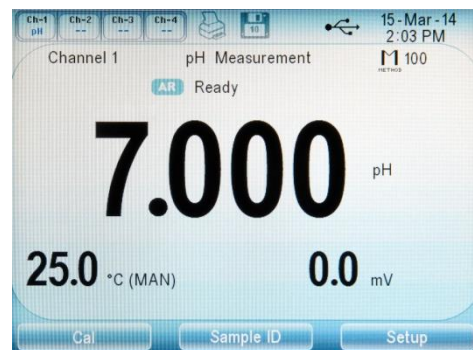

Example measurement display with limited information shown

Meter and Module Maintenance

- For routine meter and module maintenance, dust and wipe with a damp cloth. If necessary, warm water or mild water-based detergent can be used.
- Meter maintenance can be performed on a daily, weekly or monthly basis, as required by the operating environment.
- Remove any spilled substances immediately from the meter or module using the proper cleaning procedure for that spill type.

3

Chapter 3 Meter Setup Menus



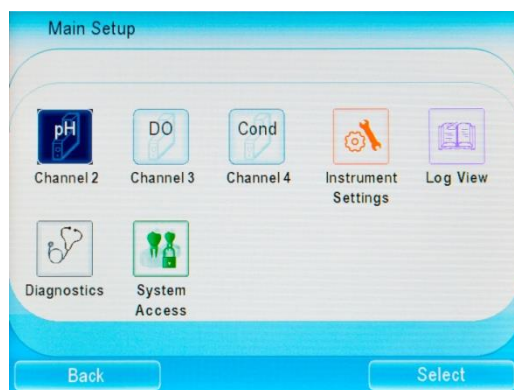





Main Setup Menu



The Main Setup menu of the Versa Star Pro meter organizes the menus for channel-specific measurement settings, instrument settings, calibration and data log, and meter diagnostics in one easy to access location. This allows quick and easy navigation to view or change measurement and instrument settings, view calibration and data history, and perform a meter self-test or view meter and module serial number and software revisions.

Since the Versa Star Pro meter offers four channels that can be configured in any combination, one to four channel-specific setup menus will be shown in the Main Setup menu, depending on the number of measurement modules that are actively connected to the meter.

1. In the measurement mode, press the **setup** key to access the Main Setup menu.
2. Press the **▲**, **▼**, **◀** or **▶** key to highlight a setup menu from the list and press the **f3 (Select)** key to access the submenus and parameters for the selected setup menu.

Icon	Setup Menu	Description
	Channel 1	<p>The Channel 1 setup menu will only be shown when a measurement module is connected with the meter input labeled Channel 1.</p> <p>The type of module will define which measurement parameters and settings are available for the Channel 1 setup menu and the channel icon shows the current measure mode (i.e. pH, ISE, Cond, RDO) for the module.</p> <p>Use the Channel 1 setup menu to customize the measurement parameter settings for the module connected to the meter input labeled Channel 1.</p>
	Channel 2	<p>The Channel 2 setup menu will only be shown when a measurement module is connected with the meter input labeled Channel 2.</p> <p>The type of module will define which measurement parameters and settings are available for the Channel 2 setup menu and the channel icon shows the current measure mode (i.e. pH, ISE, Cond, RDO) for the module.</p> <p>Use the Channel 2 setup menu to customize the measurement parameter settings for the module connected to the meter input labeled Channel 2.</p>
	Channel 3	<p>The Channel 3 setup menu will only be shown when a measurement module is connected with the meter input labeled Channel 3.</p> <p>The type of module will define which measurement parameters and settings are available for the Channel 3 setup menu and the channel icon shows the current measure mode (i.e. pH, ISE, Cond, RDO) for the module.</p> <p>Use the Channel 3 setup menu to customize the measurement parameter settings for the module connected to the meter input labeled Channel 3.</p>
	Channel 4	<p>The Channel 4 setup menu will only be shown when a measurement module is connected with the meter input labeled Channel 4.</p> <p>The type of module will define which measurement parameters and settings are available for the Channel 4 setup menu and the channel icon shows the current measure mode (i.e. pH, ISE, Cond, RDO) for the module.</p> <p>Use the Channel 4 setup menu to customize the measurement parameter settings for the module connected to the meter input labeled Channel 4.</p>
	Instrument Settings	Use the Instrument Settings setup menu to update meter settings for the display, sound, date and time, language, data transfer, stirrer speed and channel assignment, screen saver and auto-shutoff feature.
	Log View	Access the Log View menu to view the data log and calibration log, print or delete the data log, and print or delete the calibration log. The calibration log will show up to 30 most recent calibrations per parameter.
	Diagnostics	Access the Diagnostics menu to initiate a meter reset, test electrode stability, perform a meter self-test or view meter and module serial numbers and software revisions.
	System Access	Use the System Access menu to enable the system access feature, assign administrator and up to ten user accounts, log in or log out of an existing account and disable the system access feature.

Channel 1-4 Setup Menus

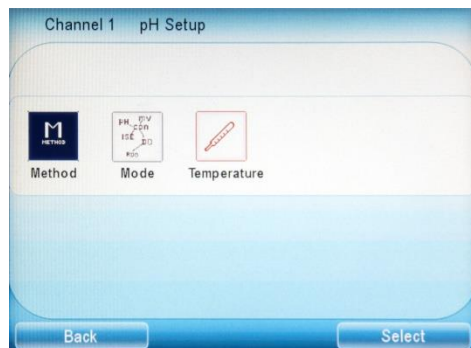

Within the Channel 1, Channel 2, Channel 3 and Channel 4 setup menus are Method, Mode and Temperature submenus, which can be used to customize measurement settings and parameters for the selected channel. The number of channel-specific setup menus and the options within each channel-specific setup menu will vary depending on the number and types of modules that are connected to the meter.

- Access the Method menu to load, copy, edit, create or delete methods.
- Select the Mode menu to review and update the measure mode and parameter settings for the selected channel and module. Refer to the individual module chapters for detailed information on the available settings for each measure mode.
- Use the Temperature menu to set the temperature units, set the temperature input source, perform a temperature calibration on an ATC temperature probe, conductivity probe with built-in temperature or dissolved oxygen probe with built-in temperature when connected to the meter or to enter a manual temperature value. The settings shown below may be different depending on the type and number of modules connected to the meter.
- When using an ion selective electrode (ISE) and Versa Star pH/ISE module, use the Incremental Techniques menu to perform a single known addition, single known subtraction, double known addition, double known subtraction, single analate addition or single analate subtraction analysis.



- When using a Thermo Scientific™ Orion™ RDO™ optical dissolved oxygen probe and Versa Star RDO/DO module, use the RDO Electrode Info menu to view the serial number, remaining useful life and date of manufacture of the optical cap.

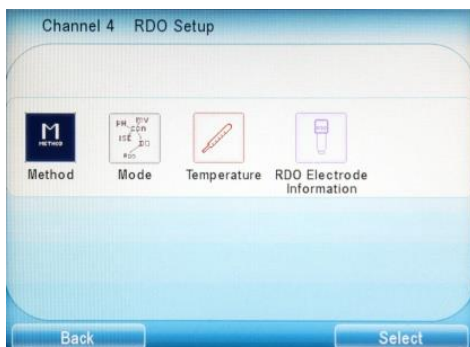

Main Menu	Submenu	Settings
Method	Load	Method list from selected channel to load a method
	Copy	Method list from selected channel to copy a method
	Edit/Create	Method list from selected channel to edit existing method or create a new method
	Delete	Method list from selected channel to delete a method
Mode	<i>Module dependent</i>	<i>Module dependent, refer to individual module chapters</i>
Temperature	Temperature Unit	°C °F
	Temperature Input	Ch1-ATC Ch2-ATC Ch3-ATC Ch4-ATC MAN
	Temperature Cal	MAN Ch#-ATC Ch#-LogR All ATC (Module and setting dependent)
Incremental Techniques (Module dependent)	Single Known Addition	The Incremental Techniques menu is displayed only when the measure mode is set to ISE using the pH/ISE module. Refer to Chapter 4 pH, pH/ISE and pH/LogR Measurement Modules for detailed information on the incremental technique functions.
	Single Known Subtraction	
	Double Known Addition	
	Double Known Subtraction	
	Single Analate Addition	
	Single Analate Subtraction	
RDO Electrode Information (Module dependent)	Serial No: Cap Life Left: Date of Mfg:	The RDO Electrode Information menu is displayed only when an RDO probe is connected to the meter using the RDO/DO module.

Note: If a new module is connected to the meter, return to the measurement mode, wait for the Channel ID display to update with the new module and then access the Main Setup menu. This ensures the channel-specific setup menu for the new module will be displayed corrected.

Method Menu



Up to ten methods can be saved per channel in the Method menu within the Channel 1, Channel 2, Channel 3 and Channel 4 setup menus for fast and easy recollection of a specific measure mode, settings and setup parameters. The default method (M100, M200, M300 and M400) is updated whenever the measure mode and channel setup parameters are changed.

When a custom method is created, loaded and active in the measurement mode and a calibration is performed, that calibration will be saved to the method so every time the method is loaded, the corresponding calibration will also be loaded. This feature is helpful when using two or more electrodes on one channel. For example, a pH electrode and an ion selective electrode (ISE) used on the same VSTAR-ISE pH/ISE module or a low range conductivity probe and a standard range conductivity probe used on the same VSTAR-CND conductivity module.

Edit / Create

1. In the measurement mode, press the **setup** key.
2. Press the ▲, ▼, ◀ or ▶ key to highlight Channel 1, Channel 2, Channel 3 or Channel 4 and press the **f3 (Select)** key.
3. Press the ◀ or ▶ key to highlight Method and press the **f3 (Select)** key.
4. Press the ▲ or ▼ key to highlight Edit / Create and press the **f3 (Select)** key.
5. Press the ▲ or ▼ key to highlight an existing method to edit or a new method to create and press the **f3 (Edit)** key.
6. Press the ◀ or ▶ key to highlight a desired measure mode and press the **f3 (Select)** key.
7. The meter will display the appropriate setup menu for the selected measure mode. Review and update the measurement parameters for the method and then press the **f1 (Back)** key.
 - a. The displayed measure modes are dependent on the module that is connected to the selected channel and the displayed measurement setup parameters are dependent on the selected measure mode. Refer to the individual module chapters for detailed information and instructions.
8. Press the ▲ or ▼ key to highlight Load from the main methods menu and load the custom method or press the **measure (esc)** key to return to the measurement mode.

Load

Use the load function to activate a method for use in the measurement mode. If no custom method has been created, the default method is active. Loading a blank method (date and time shown as dashes on the method list) will activate the default measure mode and channel setup parameters for that channel.

Copy

Use the copy function to duplicate an existing custom method (measure mode, settings and setup parameters) to a new or different method. If two or more channels have the same measurement capabilities (i.e. two channels with a pH module), then methods can be copied between channels. Copying methods is a good way to preserve an original copy of a custom method and then create a new custom method based on the previous method settings.

Delete

Use the delete function to reset an existing method to the default measure mode, settings and setup parameters for the selected channel.

Mode Menu

1. In the measurement mode, press the **setup** key.
2. Press the ▲, ▼, ◀ or ▶ key to highlight Channel 1, Channel 2, Channel 3 or Channel 4 and press the **f3 (Select)** key.
3. Press the ◀ or ▶ key to highlight Mode and press the **f3 (Select)** key.
4. The available measure modes will depend on the type of module connected with the selected channel.
 - a. For the pH module, press the ▲ or ▼ key to highlight the pH, mV, Relative mV or ORP measure mode and press the **f3 (Select)** key.
 - b. For the pH/ISE module, press the ▲ or ▼ key to highlight the pH, mV, Relative mV, ORP or ISE measure mode and press the **f3 (Select)** key.
 - c. For the pH/LogR module, press the ▲ or ▼ key to highlight the pH, mV, Relative mV or ORP measure mode and press the **f3 (Select)** key.
 - d. For the conductivity module, press the ▲ or ▼ key to highlight the conductivity, TDS, Salinity or Resistivity measure mode and press the **f3 (Select)** key.
 - e. The RDO/DO module will proceed directly into the measure mode settings and setup parameters menu.
5. Press the ▲ or ▼ key to highlight a menu option and press the ◀ or ▶ key to highlight a submenu option. Common settings include Electrode Serial Number, Sample ID, Stability, Averaging, Read Type and Alarm. Onscreen text prompts provide instructions for changing parameters within a selected menu option.
 - a. Use the popup alphanumeric keypad screen for menu options including Electrode Serial Number and Sample ID.
 - i. Press the ▲, ▼, ◀ or ▶ key to highlight a character, press the **f2 (Enter)** key to input the character and repeat until the desired label is entered.

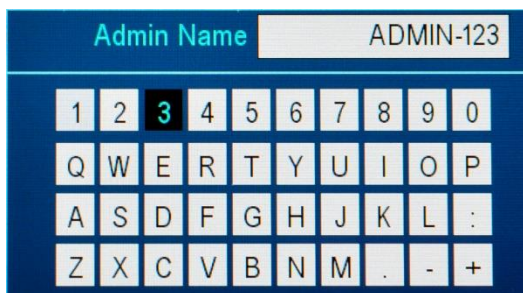

- ii. Press the **f1 (Done)** key to save the entry.
6. Refer to the individual module chapters for detailed information on the available settings for each measure mode.

Temperature Menu

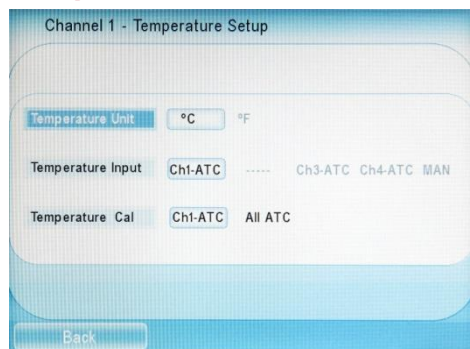

Temperature settings can be updated in the Temperature menus within the Channel 1, Channel 2, Channel 3 and Channel 4 setup menus. ATC (Automatic Temperature Compensation) probes are defined as both separate temperature probes and those built into electrodes.

Temperature Unit

Versa Star Pro meters are capable of displaying the temperature units as degrees Celsius (°C) or degrees Fahrenheit (°F).

1. In the measurement mode, press the **setup** key.
2. Press the **▲**, **▼**, **◀** or **▶** key to highlight Channel 1, Channel 2, Channel 3 or Channel 4 and press the **f3 (Select)** key.
3. Press the **◀** or **▶** key to highlight Temperature and press the **f3 (Select)** key.
4. Press the **▲** or **▼** key to highlight Temperature Unit and press the **◀** or **▶** key to highlight **°C** or **°F** as the displayed temperature units.
5. Press the **measure (esc)** key to return to the measurement mode.

Temperature Input

The temperature source for each channel can be set to any available ATC probe connected to the meter. Only channels with an ATC probe actively connected will be shown and selectable. The temperature source can also be set to manual (MAN) using this menu.

One ATC probe can be used for multiple channels. For example, when a pH electrode and conductivity probe with built-in temperature sensor are measuring the same sample, the pH electrode on channel 1 can use a conductivity probe on channel 2 as the temperature source, so a second ATC probe is not needed.

1. In the measurement mode, press the **setup** key.
2. Press the **▲**, **▼**, **◀** or **▶** key to highlight Channel 1, Channel 2, Channel 3 or Channel 4 and press the **f3 (Select)** key.
3. Press the **◀** or **▶** key to highlight Temperature and press the **f3 (Select)** key.

4. Press the ▲ or ▼ key to highlight Temperature Input and press the ◀ or ▶ key to highlight an available ATC probe (i.e. Ch2-ATC) as the temperature source or highlight MAN for manual temperature input.
 - a. This setting will determine which options are available in the Temperature Cal menu.
5. Press the **measure (esc)** key to return to the measurement mode or proceed to Step 4 in the Temperature Cal menu section.

Temperature Cal

A temperature calibration can be performed for individual ATC probes or simultaneously for all ATC probes connected to the meter. A manual temperature value can also be entered using the Temperature Cal menu if the MAN setting is selected in the Temperature Input menu.

The meter has a relative temperature accuracy of $\pm 0.1^\circ\text{C}$. ATC probes have varying relative temperature accuracies, usually $\pm 0.5^\circ\text{C}$ to $\pm 2^\circ\text{C}$. Use the temperature calibration function only when necessary. It is recommended that two NIST-traceable thermometers be used to measure and verify the calibration solution temperature. Since the temperature offset calculated during the calibration is applied to all future temperature measurements, recalibrate the temperature if a different ATC probe is used.

ATC Probe Temperature Calibration

Prepare and connect all ATC probes to be calibrated to the appropriate module inputs on the selected channels.

1. In the measurement mode, press the **setup** key.
2. Press the ▲, ▼, ◀ or ▶ key to highlight Channel 1, Channel 2, Channel 3 or Channel 4 and press the **f3 (Select)** key.
3. Press the ◀ or ▶ key to highlight Temperature and press the **f3 (Select)** key.
4. Press the ▲ or ▼ key to highlight Temperature Cal and press the ◀ or ▶ key to highlight the individual ATC probe selected in the Temperature Input menu (i.e. Ch2-ATC) or All ATC and press the **f3 (Select)** key.
5. Place the ATC probes into a solution with a known, stable temperature. It is recommended that two NIST-traceable thermometers be used to measure and verify the temperature.
6. Press the **f3 (Edit)** key, use the numeric keypad to enter the temperature of the solution and press the **f2 (Accept)** key to save the temperature value and update the offset.
7. If applicable, press the ▲ or ▼ key to highlight the reference temperature of the next ATC probe and repeat steps 3 and 4 for each ATC probe connected to the meter.
8. Once all ATC probes are calibrated, press the **f1 (Back)** key to exit the calibration and press the **measure (esc)** key to return to the measurement mode.

Refer to [Chapter 4 pH, pH/ISE and pH/LogR Measurement Modules](#) for detailed instructions on performing a LogR temperature calibration with a glass-bulb pH electrode when using the Versa Star Pro meter with pH/LogR measurement module.

Manual Temperature Entry

Enter a manual temperature value when MAN is selected in the Temperature Input menu.

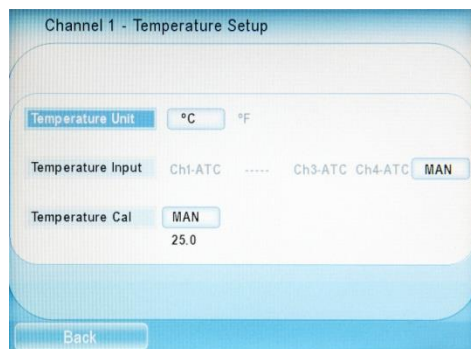

1. In the measurement mode, press the **setup** key.
2. Press the ▲, ▼, ◀ or ▶ key to highlight Channel 1, Channel 2, Channel 3 or Channel 4 and press the **f3 (Select)** key.
3. Press the ◀ or ▶ key to highlight Temperature and press the **f3 (Select)** key.
4. Press the ▲ or ▼ key to highlight Temperature Cal and press the **f3 (Select)** key.
5. Press the **f3 (Clear)** key, input the temperature value using the numeric keypad and then press the **f2 (Enter)** key to save the value.
6. Press the **measure (esc)** key to return to the measurement mode.

Instrument Settings Setup Menu

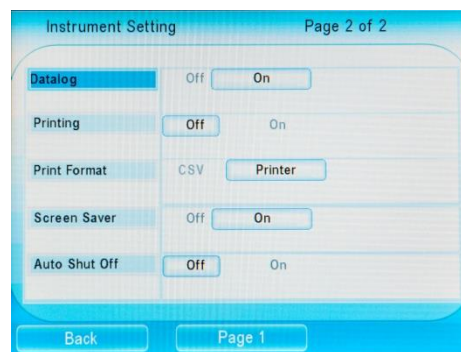

Use the Instrument Settings menu to review and update meter settings. The default settings are in bold or shown with the selection box checked in the following table. To navigate the menu, press the ▲ or ▼ key to highlight a main menu option and press the ◀ or ▶ key to highlight a submenu option. Onscreen text prompts provide instructions for changing parameters.

- **Display** – Adjust the display brightness, select the information shown on the measurement display and set which channel combinations are shown when the **Channel** key is pressed.
- **Communication** – Select the method used for information transfer to an external device and set the baud rate when RS232 is selected as the transfer method.
- **Buzzer** – Turn the sound on or off each time a key is pressed, when the main measurement value becomes stable and when an alarm is triggered.
- **Stirrer** – Connect one or two Orion Star stirrer probes (Cat. No. 096019) to the meter, assign a stirrer probe to each measurement channel and set the stirring speed of each stirrer probe from 1 (slowest) to 5 (fastest).
- **Calendar** – Enter the time, set the time format as 12 hours (am/pm) or 24 hours, enter the date and set the date format as Day-Month-Year (all numeric), Month-Day-Year (all numeric) or Day-Month-Year (DD-MMM-YY, three letter short form of month).
- **Language** – Set the language used for the meter interface.
- **Data log** – Turn the data log function on or off.
- **Printing** – Turn the printing function to an external device on or off.
- **Printing Format** – Select how information will be transferred to an external device, as comma delimited (CSV) or standard text (Printer).
- **Screen Saver** – Turn the screen saver on or off. The screen saver is shown when the meter enters auto-shutoff mode or when the meter is manually put into standby mode by pressing the power key. The time is displayed when the screen saver is on and a blank display is shown when the screen saver is off.
- **Auto-Shutoff** – Turn the meter automatic shutoff feature on or off.

Main Menu	Submenu	Settings								
Display	Brightness	Level 1	Level 2	Level 3		Level 4	Level 5			
	Display View	Channel		<input checked="" type="checkbox"/>	Secondary Parameter		<input checked="" type="checkbox"/>			
		Measurement Mode		<input checked="" type="checkbox"/>	Calibration Details		<input checked="" type="checkbox"/>			
Method			<input checked="" type="checkbox"/>	Account ID		<input checked="" type="checkbox"/>				
Stable			<input checked="" type="checkbox"/>	Sample ID		<input checked="" type="checkbox"/>				
Temperature			<input checked="" type="checkbox"/>	Electrode Serial No.		<input checked="" type="checkbox"/>				
Display Format	Channel 1		<input checked="" type="checkbox"/>	Channel 2 & 4		<input checked="" type="checkbox"/>				
	Channel 2		<input checked="" type="checkbox"/>	Channel 3 & 4		<input checked="" type="checkbox"/>				
	Channel 3		<input checked="" type="checkbox"/>	Channel 1 & 2 & 3		<input checked="" type="checkbox"/>				
	Channel 4		<input checked="" type="checkbox"/>	Channel 1 & 2 & 4		<input checked="" type="checkbox"/>				
	Channel 1 & 2		<input checked="" type="checkbox"/>	Channel 1 & 3 & 4		<input checked="" type="checkbox"/>				
	Channel 1 & 3		<input checked="" type="checkbox"/>	Channel 2 & 3 & 4		<input checked="" type="checkbox"/>				
	Channel 1 & 4		<input checked="" type="checkbox"/>	Channel 1 & 2 & 3 & 4		<input checked="" type="checkbox"/>				
	Channel 2 & 3		<input checked="" type="checkbox"/>			<input checked="" type="checkbox"/>				
Communication	USB									
	RS232	1200	2400	4800	9600	19200	38400	57600	115200	
	USB PRINTER									
Buzzer	Key Press	Off	On							
	Ready	Off	On							
	Alarm	Off	On							
Stirrer	Stirrer	Channel 1	Stirrer 1			Stirrer 2				
		Channel 2	<input type="checkbox"/>	<input checked="" type="checkbox"/>		<input checked="" type="checkbox"/>		<input checked="" type="checkbox"/>		
		Channel 3	<input checked="" type="checkbox"/>	<input type="checkbox"/>		<input type="checkbox"/>		<input type="checkbox"/>		
		Channel 4	<input checked="" type="checkbox"/>	<input type="checkbox"/>		<input type="checkbox"/>		<input type="checkbox"/>		
		Speed	1	2	3	4	5	1	2	3
Calendar	Time	Format	12 Hrs	24Hrs	Hour	Minutes	AM	PM		
	Date	Format	DD-MM-YY	MM-DD-YY	DD-MMM-YY	Day	Month	Year		
Language	<i>Current setting</i>	English	Spanish	German	Italian	French	Chinese	Portuguese	Korean	
Data Log		Off	On							
Printing		Off	On							
Print Format		CSV	Printer							
Screen Saver		Off	On							
Auto Shut Off		Off	On							

Log View Menu

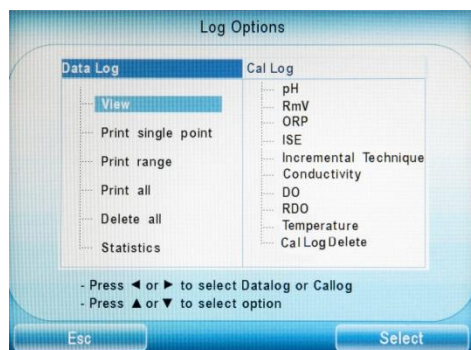

Use the Log View menu to access the data log and calibration log. All information in the data and calibration logs is protected by the nonvolatile memory, so stored information is saved in the meter even when it is not connected to a power supply.

Data Log

Versa Star Pro meters offer a 2000 point data log. Each point includes measurements from one to four channels, depending on which channels were actively displayed in the measurement mode when the point was saved. When the data log function is turned on, the read type selected for each displayed channel (Auto-Read, Timed, Single-Shot or Continuous) determines how the point is saved to the data log. Refer to the [Measurement Read Types](#) section for detailed information sending measurements to the data log.

1. In the measurement mode, press the **setup** key.
2. Press the ▲, ▼, ◀ or ▶ key to highlight Log View and press the **f3 (Select)** key.
3. Press the ◀ or ▶ key to highlight Data Log.
4. To view the log, press the ▲ or ▼ key to highlight View and press the **f3 (Select)** key. A list of the saved data log points will be displayed with the data log numbers, main measurement value of each channel, date and time.
 - a. Press the ▲ or ▼ key to highlight a point and press the **enter** key to view detailed data for that point.
 - b. When viewing individual data log points, press the ◀ or ▶ key to scroll through additional data log points.
5. To print the log, press the ▲ or ▼ key to highlight Print single point, Print range or Print all and press the **f3 (Select)** key.
 - a. For a single point or range, enter the data point values and press the **f3 (Print)** key.
6. To delete the log, press the ▲ or ▼ key to highlight Delete all and press the **f3 (Select)** key. Press the **f1 (Yes)** key to delete the log or press the **f3 (No)** key to cancel the function.
7. To view statistics, press the ▲ or ▼ key to highlight Statistics and press the **f3 (Select)** key. Press the ▲ or ▼ key to select a measure mode and the statistical values for all data log points with the selected measure mode will be displayed.

Calibration Log

Log #	Log Date & Time	Channel	Electrode	User ID	Method No	Module No
102	15-Mar-14, 2:12 PM	1	----	----	100	SAMPLE-01
101	15-Mar-14, 1:06 PM					

Pt#	pH	mV	Temp °C	Avg. Slope
1	2.000	290.4	25.0	
2	4.010	174.2	25.0	
3	6.997	0.0	25.0	98.1 x
4	10.013	-173.8	25.0	
5	12.000	-289.7	25.0	

Slope	P1-P2	P2-P3	P3-P4	P4-P5	P5-P6
x	97.7 %	98.6 %	97.4 %	98.6 %	-----
Offset mV	1.3	-0.2	-0.2	1.9	-----

The calibration log contains up to the 30 most recent calibrations per measure mode of pH, RmV, ORP, ISE, incremental technique, conductivity, DO, RDO and temperature.

1. In the measurement mode, press the **setup** key.
2. Press the **▲**, **▼**, **◀** or **▶** key to highlight Log View and press the **f3 (Select)** key.
3. Press the **◀** or **▶** key to highlight Cal Log.
4. To view the calibration log, press the **▲** or **▼** key to highlight the desired calibration parameter and press the **f3 (Select)** key.
 - a. Details for up to the last 30 calibrations by parameter will be displayed.
 - b. Press the **▲** or **▼** key to view each calibration for the selected parameter.
 - c. Press the **f3 (Print)** key to export the selected calibration log to a printer or computer.

Calibration Log Delete Function

When the calibration log delete function is turned on and 30 calibrations have been saved for a parameter, the meter will not overwrite an existing calibration log with a new calibration until the calibration log is manually deleted. This function is helpful for strict data tracking requirements, since it alerts the operator when a calibration log is full before any calibration logs are overwritten. It is also useful when the System Access feature is enabled, since individual user accounts can be given permission to access the calibration log delete function or blocked from accessing this function. The default setting for the calibration log delete function is off.

1. In the measurement mode, press the **setup** key.
2. Press the **▲**, **▼**, **◀** or **▶** key to highlight Log View and press the **f3 (Select)** key.
3. Press the **◀** or **▶** key to highlight Cal Log.
4. Press the **▲** or **▼** key to highlight Calibration Log Delete and press the **f3 (Select)** key.
5. Press the **f2 (On)** key to enable the calibration log delete function.
6. Once the calibration log delete function is turned on, repeat steps 1-5 to delete the calibration log or turn off the calibration log delete function.

Diagnostics Menu

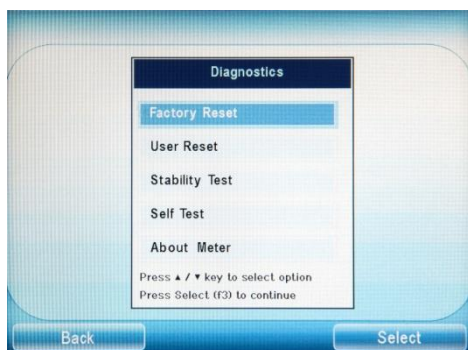

Use the Diagnostics Menu to initiate a meter reset, test electrode stability, perform a meter self-test or view meter and module serial numbers and software revisions.

- **Factory Reset** – All meter settings are reset to factory defaults. Data log, calibration log and methods are deleted. If System Access feature is enabled, all system restrictions (names, passwords and access levels) are also deleted.
- **User Reset** – All settings for the selected channel are reset to factory defaults. Data log, calibration log and methods are retained.
- **Stability Test** – Tests the stability of a pH electrode, ORP electrode or ion selective electrode (ISE) by measuring the mV per minute drift and noise of the electrode.
- **Self-Test** – Tests the keypad, meter accuracy and stirrer inputs. A self-test is also performed automatically by the meter at each power up.
- **About Meter** – Displays the meter and module software revisions and serial numbers.

Main Menu	Submenu		Notes	
Factory Reset	Password		Default password is 1111	
User Reset	Channel 1		The channel setup menu for the selected channel will be reset to default settings.	
	Channel 2			
	Channel 3			
	Channel 4			
Stability Test	Channel #		Only channels with BNC connectors are displayed in the stability test submenu.	
	Channel #			
Self Test	Keypad check		The accuracy check is performed on channels with BNC connectors only. A stirrer probe (part # 096019) is required to perform the stirrer check.	
	Accuracy check			
	Stirrer check			
About Meter		Serial No.	SW Rev.	The meter serial number and software revision will be different from the module serial numbers and software revisions.
	Meter	#####	###	
	Channel 1	#####	###	
	Channel 2	#####	###	
	Channel 3	#####	###	
	Channel 4	#####	###	

System Access Menu

Use the System Access menu offered with Orion Versa Star Pro meters to assign an administrator and up to ten user accounts with custom access to meter functions. Assign each user account a full, advanced or basic predefined access level or select the custom access level to modify individual access to the meter functions listed in the following table.

Meter Access Options	Admin	Full	Advanced	Basic	Custom
Create/Edit Accounts	<input checked="" type="checkbox"/>	---	---	---	---
Instrument Settings	<input checked="" type="checkbox"/>	<input checked="" type="checkbox"/>	<input type="checkbox"/>	<input type="checkbox"/>	<input type="checkbox"/> / <input checked="" type="checkbox"/>
Data Log Delete	<input checked="" type="checkbox"/>	<input checked="" type="checkbox"/>	<input type="checkbox"/>	<input type="checkbox"/>	<input type="checkbox"/> / <input checked="" type="checkbox"/>
Calibration Log Delete	<input checked="" type="checkbox"/>	<input checked="" type="checkbox"/>	<input type="checkbox"/>	<input type="checkbox"/>	<input type="checkbox"/> / <input checked="" type="checkbox"/>
Diagnostics Menu	<input checked="" type="checkbox"/>	<input checked="" type="checkbox"/>	<input type="checkbox"/>	<input type="checkbox"/>	<input type="checkbox"/> / <input checked="" type="checkbox"/>
Methods	<input checked="" type="checkbox"/>	<input checked="" type="checkbox"/>	<input checked="" type="checkbox"/>	<input type="checkbox"/>	<input type="checkbox"/> / <input checked="" type="checkbox"/>
Temperature Settings	<input checked="" type="checkbox"/>	<input checked="" type="checkbox"/>	<input checked="" type="checkbox"/>	<input type="checkbox"/>	<input type="checkbox"/> / <input checked="" type="checkbox"/>
Calibration Mode	<input checked="" type="checkbox"/>	<input checked="" type="checkbox"/>	<input checked="" type="checkbox"/>	<input checked="" type="checkbox"/>	<input type="checkbox"/> / <input checked="" type="checkbox"/>
Measure Mode & Settings	<input checked="" type="checkbox"/>	<input checked="" type="checkbox"/>	<input checked="" type="checkbox"/>	<input checked="" type="checkbox"/>	<input checked="" type="checkbox"/> / <input type="checkbox"/>
Incremental Techniques	<input checked="" type="checkbox"/>	<input checked="" type="checkbox"/>	<input checked="" type="checkbox"/>	<input checked="" type="checkbox"/>	<input checked="" type="checkbox"/> / <input type="checkbox"/>
Data Log View	<input checked="" type="checkbox"/>	<input checked="" type="checkbox"/>	<input checked="" type="checkbox"/>	<input checked="" type="checkbox"/>	<input checked="" type="checkbox"/> / <input type="checkbox"/>
Data Log Print	<input checked="" type="checkbox"/>	<input checked="" type="checkbox"/>	<input checked="" type="checkbox"/>	<input checked="" type="checkbox"/>	<input checked="" type="checkbox"/> / <input type="checkbox"/>
Cal Log View & Print	<input checked="" type="checkbox"/>	<input checked="" type="checkbox"/>	<input checked="" type="checkbox"/>	<input checked="" type="checkbox"/>	<input checked="" type="checkbox"/> / <input type="checkbox"/>
Log/Print (Manual)	<input checked="" type="checkbox"/>	<input checked="" type="checkbox"/>	<input checked="" type="checkbox"/>	<input checked="" type="checkbox"/>	<input checked="" type="checkbox"/> / <input type="checkbox"/>
Channel Display Option	<input checked="" type="checkbox"/>	<input checked="" type="checkbox"/>	<input checked="" type="checkbox"/>	<input checked="" type="checkbox"/>	<input checked="" type="checkbox"/> / <input type="checkbox"/>
Sample ID	<input checked="" type="checkbox"/>	<input checked="" type="checkbox"/>	<input checked="" type="checkbox"/>	<input checked="" type="checkbox"/>	<input checked="" type="checkbox"/> / <input type="checkbox"/>

If the custom access level is selected, the admin can select which meter functions are accessible or blocked using the list of meter access options shown below. The custom settings can be unique for each account.



Enabling the System Access Feature

Note: Record all names and passwords in a safe location!

1. In the measurement mode, press the **setup** key.
2. Press the **▲**, **▼**, **◀** or **▶** key to highlight System Access and press the **f3 (Select)** key.



3. Press the **f3 (Admin)** key to proceed with setting up the administrator account.

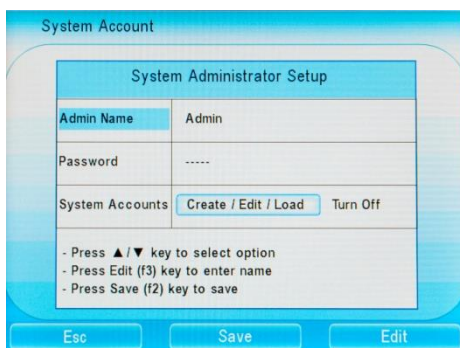

4. Press the **▲** or **▼** key to highlight Admin Name and press the **f3 (Edit)** key. Use the alphanumeric keypad to enter one to ten characters for the system administrator name.



- a. Press the **▲**, **▼**, **◀** or **▶** key to highlight a character, press the **f2 (Enter)** key to input the character and repeat until the desired name is entered.
- b. Press the **f3 (Clear)** key to delete any undesired characters.
- c. Press the **f1 (Done)** key to save the entry.

5. Press the ▲ or ▼ key to highlight Password and press the **f3 (Edit)** key.
6. Use the meter keypad to enter one to six numbers for the system administrator password and press the **f2 (Accept)** key.

7. Press the ◀ or ▶ key to highlight Create/Edit/Load and press the **f3 (Select)** key.
8. The list of accounts will be shown with the Admin account and ten available user accounts.

Account Name	Last Access Date	Access Level
ADMIN-123 (Admin)	19-03-16	Full
-----	-----	-----
-----	-----	-----
-----	-----	-----
-----	-----	-----
-----	-----	-----
-----	-----	-----
-----	-----	-----
-----	-----	-----
-----	-----	-----

9. Press the ▲ or ▼ key to highlight a new user account and press the **f3 (Edit)** key.

10. Press the ▲ or ▼ key to highlight Account Name and press the **f3 (Edit)** key. Use the alphanumeric keypad to enter one to ten characters for the user account name.
 - a. Press the ▲, ▼, ◀ or ▶ key to highlight a character, press the **f2 (Enter)** key to input the character and repeat until the desired name is entered.
 - b. Press the **f3 (Clear)** key to delete any undesired characters.
 - c. Press the **f1 (Done)** key to save the entry.

11. Press the ▲ or ▼ key to highlight Password and press the **f3 (Edit)** key.
12. Use the meter keypad to enter one to six numbers for the user account password and press the **f2 (Accept)** key.

13. Press the ◀ or ▶ key to highlight the desired account access level of Full, Advanced, Basic or Custom.
 - a. If Full, Advanced or Basic is selected, press the **f2 (Save)** key and the meter will use the preset access level settings and return to the list of accounts.
 - b. If Custom is selected, press the **f3 (Select)** key and a new screen will open with a list of meter access options. The custom settings can be unique for each account.

- i. Press the ▲ or ▼ key to highlight an option and press the **f3 (Select)** key to allow access (checked box) or prevent access (unchecked box).
- ii. Once all options have been set, press the **f1 (Done)** key. The custom settings will be saved for the account and the meter will return to the list of accounts.

Account Name	Last Access Date	Access Level
ADMIN-123 (Admin)	19-03-16	Full
ACCT-0001	19-03-16	Custom

14. Repeat steps 9-13 for all required user accounts.
15. When the administrator account is active, the administrator can use the list of accounts to load and activate a different user account.

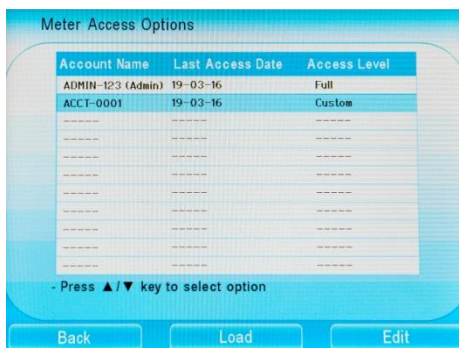

- a. Press the ▲ or ▼ key to highlight the account and press the **f2 (Load)** key to activate the selected account.
 - i. Only accounts with a defined name, password and access level can be loaded.
- b. Once the account is loaded, the meter will return to the measurement mode and the loaded, activated account name will be shown in the single measurement display.

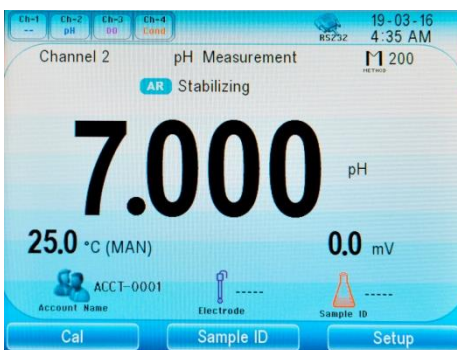

- c. The active account will only be able to access the meter functions defined by their account's access level setting (Full, Advanced, Basic or Custom).
- d. The active account name will be saved with subsequent data log and calibration log records until the active account logs out or a new account logs in.
- e. Only the system admin can create and edit up to ten user accounts with name, password and access level setting. The system admin can overwrite the name and password of existing user accounts, but accounts cannot be deleted.
- f. Only the system administrator can turn off the System Access feature. Turning off the System Access feature will disable all system restrictions and erase all admin and user account names, passwords and access level settings.

Logging into the Administrator Account

Use the following procedure to log into the admin account after the System Access feature has been enabled and the system admin has been set.

1. In the measurement mode, press the **setup** key.
2. Press the **▲**, **▼**, **◀** or **▶** key to highlight System Access and press the **f3 (Select)** key.
3. Press the **f3 (Admin)** key to access the administrator account.



4. Use the meter keypad to enter the administrator password and press the **f2 (Accept)** key.
5. The System Administrator Setup screen will open. From this screen, the system administrator can edit their name and password, create a new user account, edit an existing user account, load an existing account or turn off the System Access feature.

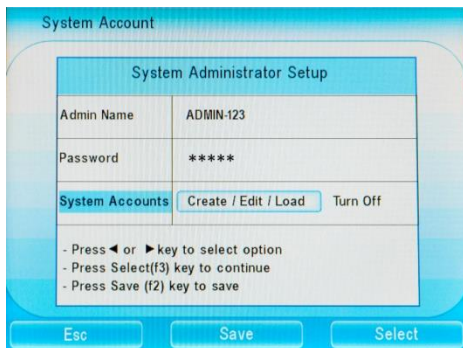

6. To load an existing account:
 - a. Press the **▲** or **▼** key to highlight System Accounts, press the **◀** or **▶** key to highlight Create/Edit/Load and press the **f3 (Select)** key.
 - b. Press the **▲** or **▼** key to highlight the account and press the **f2 (Load)** key to activate the selected account.
7. To turn off the System Access function:
 - a. Press the **▲** or **▼** key to highlight System Accounts, press the **◀** or **▶** key to highlight Turn Off and press the **f2 (Save)** key.
 - b. Press the **f3 (Turn Off)** key to confirm the action. Turning off the System Access will disable all system restrictions and erase all names, passwords and access settings.

Logging into Existing User Account

1. In the measurement mode, press the **setup** key.
2. Press the **▲**, **▼**, **◀** or **▶** key to highlight System Access and press the **f3 (Select)** key.
3. Press the **f2 (Account)** key to access the list of existing accounts.



4. Press the **▲** or **▼** key to scroll through the list of account names until the desired name is shown and then press the **f3 (Select)** key.



5. Use the meter keypad to enter the account password and press the **f2 (Load)** key.
6. Once the account is loaded, the meter will return to the measurement mode and the loaded, activated account name will be shown in the single measurement display.

Logging Out of Existing User Account

1. In the measurement mode, press the **setup** key.
2. Press the **▲**, **▼**, **◀** or **▶** key to highlight System Access and press the **f3 (Select)** key.
3. Press the **f1 (Logout)** key to log out of the active account.
4. The meter will prevent access to all meter access options until another account logs in.
 - a. With no account logged into the meter, the following meter access options will be blocked: Instrument Settings, Data Log Delete, Calibration Log Delete, Diagnostics Menu, Methods, Temperature Settings, Calibration Mode, Measure Mode & Settings, Incremental Techniques, Data Log View, Data Log Print, Cal Log View & Print, Log/Print (Manual), Channel Display Option and Sample ID.

4

Chapter 4 **pH, pH/ISE and pH/LogR Measurement Modules**

Connecting Electrodes to the Module

To begin using the Versa Star Pro meter and module system, prepare the meter and insert the module into an available channel on the back of the meter. See [Chapter 2 Meter Basics](#) for instructions. For information on customizing meter settings, refer to [Chapter 3 Setup Menu](#).

- It is recommended that electrodes be placed in the meter-attached electrode stand for easy movement in and out of beakers during calibration, sample measurement and storage.

Module Catalog #	VSTAR-PH	VSTAR-ISE	VSTAR-LR
Label	pH	pH/ISE	pH/LogR
Measure Modes	pH, mV, RmV, ORP	pH, mV, RmV, ORP, ISE	pH, mV, RmV, ORP
Temperature Modes	Automatic, Manual	Automatic, Manual	Automatic, Manual, LogR

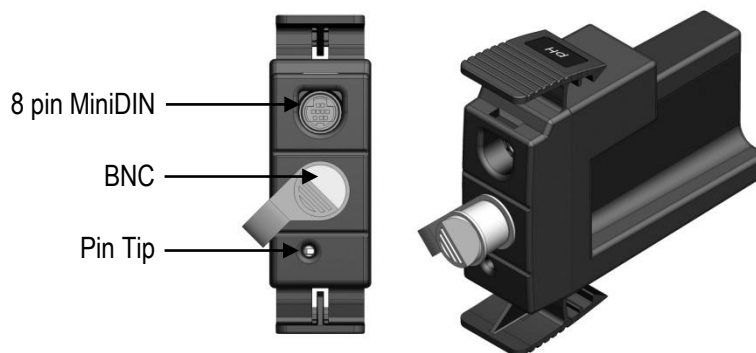
VSTAR-PH Versa Star pH Module

1. Remove the shorting cap protecting the BNC connector on the module.
2. Connect a pH electrode or ORP electrode to the BNC connector on the module.
3. Connect an ATC temperature probe to the 8 pin MiniDIN connector on the module.
4. Connect a reference half-cell electrode to the pin tip connector on the module (for use when a half-cell sensing electrode with BNC connector is used).
5. Prepare the electrodes for use as instructed in the electrode user manuals.

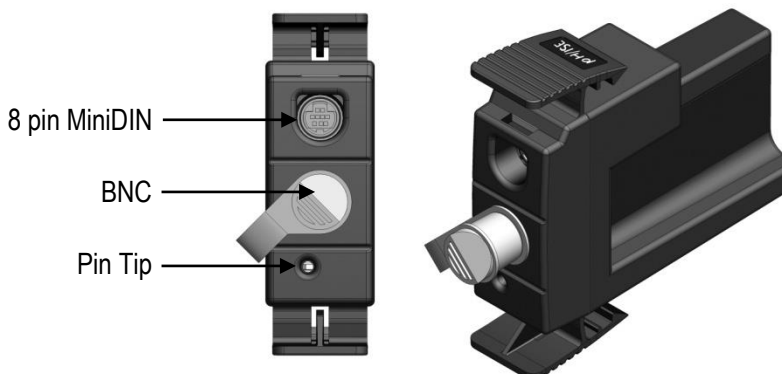
VSTAR-ISE Versa Star pH/ISE Module

1. Remove the shorting cap protecting the BNC connector on the module.
2. Connect an ion selective electrode (ISE), pH electrode or ORP electrode to the BNC connector on the module.
3. Connect an ATC temperature probe to the 8 pin MiniDIN connector on the module.
4. Connect a reference half-cell electrode to the pin tip connector on the module (for use when a half-cell sensing electrode with BNC connector is used).
5. Prepare the electrodes for use as instructed in the electrode user manuals.

VSTAR-LR Versa Star pH/LogR Module

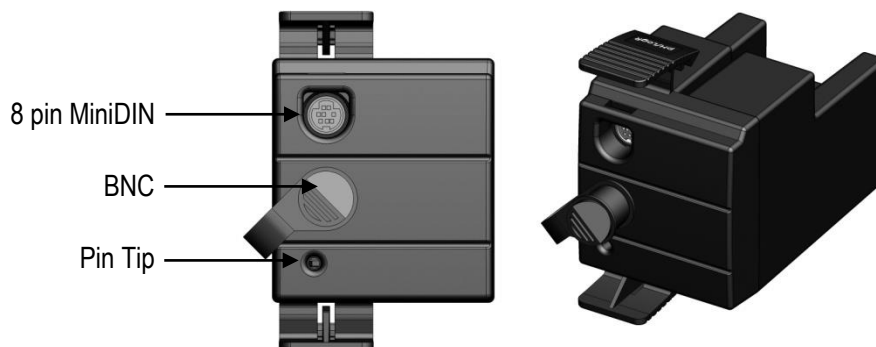

1. Remove the shorting cap protecting the BNC connector on the module.
2. Connect a pH electrode or ORP electrode to the BNC connector on the module. LogR technology allows the temperature to be measured using the glass bulb of a pH electrode.
3. Connect an ATC temperature probe to the 8 pin MiniDIN connector on the module.
4. Connect a reference half-cell electrode to the pin tip connector on the module (for use when a half-cell sensing electrode with BNC connector is used).
5. Prepare the electrodes for use as instructed in the electrode user manuals.

Example Electrode Connections



Typical BNC connector on pH electrode, ORP electrode or ion selective electrode (ISE)



Typical waterproof BNC connector on pH electrode, ORP electrode or ion selective electrode (ISE)

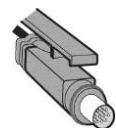

Typical 8 pin MiniDIN connector on ATC temperature probe



Typical pin tip connector on reference half-cell electrode

Channel 1-4 Setup Menus

Mode Menus for pH, mV, Relative mV, ORP and ISE

Within the Channel 1, Channel 2, Channel 3 and Channel 4 setup menus are Method, Mode and Temperature submenus, which can be used to customize measurement settings and parameters for the selected channel. When using a pH/ISE module that is set to the ISE measure mode, an Incremental Techniques submenu is also available. This section provides detailed information on the Mode menus for each measurement parameter available when using a pH, pH/ISE or pH/LogR module.

1. In the measurement mode, press the **setup** key.
2. Press the ▲, ▼, ◀ or ▶ key to highlight Channel 1, Channel 2, Channel 3 or Channel 4 and press the **f3 (Select)** key.
 - a. Select the appropriate channel number that the module of interest is connected.
3. Press the ◀ or ▶ key to highlight Mode and press the **f3 (Select)** key.



- a. The Incremental Technique option will only be shown when using the pH/ISE module.
4. Press the ▲ or ▼ key to highlight pH, mV, Relative mV, ORP or ISE and press the **f3 (Select)** key.

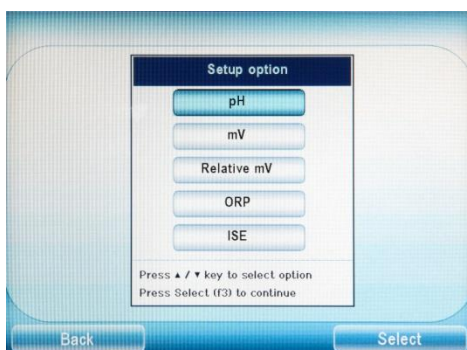

- a. The ISE option will only be shown when using the pH/ISE module.

5. Press the ▲ or ▼ key to highlight a menu option and press the ◀ or ▶ key to highlight a submenu option. Onscreen text prompts provide instructions for changing parameters within a selected menu option.



- a. Use the popup alphanumeric keypad screen for menu options including Electrode Serial Number and Sample ID.
 - i. Press the ▲, ▼, ◀ or ▶ key to highlight a character, press the **f2 (Enter)** key to input the character and repeat until the desired name is entered.
 - ii. Press the **f3 (Clear)** key to delete any undesired characters.

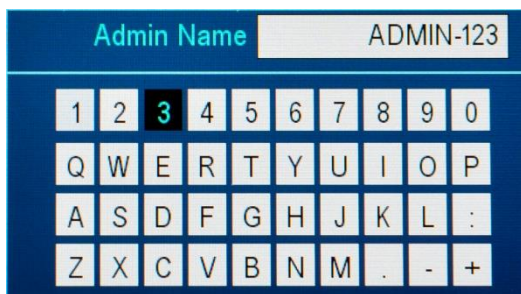

- iii. Press the **f1 (Done)** key to save the entry.

pH Mode Menu

Main Menu	Settings	Details
Electrode SI No	----	Use the alphanumeric keypad to enter the electrode serial number or clear all to shown no value (----)
Sample ID	Off , Manual, Auto Increment	Use the popup keypad screen to enter an alphanumeric manual ID or a numeric value as the starting value for auto incremental ID
Resolution	0.1, 0.01, 0.001	Set the resolution of the measurement value
Stability	Smart , Fast, Medium, Slow	Set when a measurement is recognized as stable
Averaging	Off, Automatic Smart	Set averaging for faster measurement stability
Read Type	Auto-Read , Timed, Single-Shot, Continuous	For Timed and Single-Shot, set the time in hours, minutes, seconds (HH:MM:SS) using the arrow keys
Buffer Group	USA , DIN, CUSTOM	USA: 1.68, 4.01, 7.00, 10.01, 12.46 DIN: 1.68, 4.01, 6.86, 9.18 Custom: Enter 1 to 6 buffer values ≥ 1.00 pH apart
Isopotential Value	Off, On	Default value is 7.000
Linear Regression	Off , On	Set point-to-point (Off) or single best fit (On) slope
Alarm	Limit Alarm Off , On	Set high and low limit values to activate alarm
	Cal Due Alarm Off , On	Set a calibration interval (hours) to activate alarm
	Set Point Alarm Off , On	Set a base and offset value to activate alarm

Detailed information on these features is available in the [Appendix](#) section of this user manual.

mV, Relative mV and ORP Mode Menus



Main Menu	Settings	Details
Electrode SI No	----	Use the alphanumeric keypad to enter the electrode serial number or clear all to shown no value (----)
Sample ID	Off , Manual, Auto Increment	Use the popup keypad screen to enter an alphanumeric manual ID or a numeric value as the starting value for auto incremental ID
Stability	Smart , Fast, Medium, Slow	Set when a measurement is recognized as stable
Averaging	Off, Automatic Smart	Set averaging for faster measurement stability
Read Type	Auto-Read , Timed, Single-Shot, Continuous	For Timed and Single-Shot, set the time in hours, minutes, seconds (HH:MM:SS) using the arrow keys
Alarm*	Limit Alarm Off , On	Set high and low limit values to activate alarm
	Cal Due Alarm Off , On	Set a calibration interval (hours) to activate alarm
	Set Point Alarm Off , On	Set a base and offset value to activate alarm

* The mV mode menu will not have the Cal Due Alarm option.

Detailed information on these features is available in the [Appendix](#) section of this user manual.

ISE Mode Menu (pH/ISE Module Only)

Channel 2 ISE Setup Page 1 of 2

Electrode SI No: ----

Electrode Type: F -

Sample ID: Off Manual Auto Increment

Significant Digit: 1 Digit 2 Digit 3 Digit 4 Digit

Stability: Smart Fast Medium Slow

Averaging: Off Automatic Smart

Read Type: Auto-Read Timed Single-Shot Continuous

Back Page 2 Select

Channel 2 ISE Setup Page 2 of 2

Measure Unit: ppm Molar mg/L % ppb None

Isopotential Value: Off On

Linear Regression: Off On

Blank Correction: Off On

Low Level Stability: Off On

Alarm: Limit Alarm CalDue Alarm SetPt. Alarm

Back Page 1

Main Menu	Settings	Details
Electrode SI No	----	Use the alphanumeric keypad to enter the electrode serial number or clear all to shown no value (----)
Electrode Type	Ag+ BF4- Br- Ca++ Cd++ Cl- Cl2 ClO4 CN- CO2 Cu++ F- I- K+ KF Na+ NH3 NO3- NOx O2 Pb++ REDOX S-- SCN- X- X-- X+ X++	Set the ion selective electrode (ISE) being used. If the type of ISE is not listed, select X- for monovalent anion, X-- for divalent anion, X+ for monovalent cation and X++ for divalent cation. The type of ISE selected will set the expected calibration slope range and slope direction as positive or negative.
Sample ID	Off, Manual, Auto Increment	Use the popup keypad screen to enter an alphanumeric manual ID or a numeric value as the starting value for auto incremental ID
Significant Digit	1 Digit, 2 Digit, 3 Digit, 4 Digit	Set how many significant digits will be shown for the resolution of the measurement value
Stability	Smart, Fast, Medium, Slow	Set when a measurement is recognized as stable
Averaging	Off, Automatic Smart	Set averaging for faster measurement stability
Read Type	Auto-Read, Timed, Single-Shot, Continuous	For Timed and Single-Shot, set the time in hours, minutes, seconds (HH:MM:SS) using the arrow keys
Measurement Unit	ppm, Molar, mg/L, %,ppb, None	Set the displayed measurement units
Isopotential Value	Off, On	Default value is 1.000
Linear Regression	Off, On	Set point-to-point (Off) or single best fit (On) curve
Blank Correction	Off, On	Correct for non-linearity in low level ISE readings
Low Level Stability	Off, On	Extend stability wait time for ISE calibration points
Alarm	Limit Alarm Off, On	Set high and low limit values to activate alarm
	Cal Due Alarm Off, On	Set a calibration interval (hours) to activate alarm
	Set Point Alarm Off, On	Set a base and offset value to activate alarm

Detailed information on these features is available in the [Appendix](#) section of this user manual.

pH Calibration

One to six pH buffers can be used for calibration (up to six for a custom buffer group, up to five for USA buffer group and up to four for DIN buffer group). Always use fresh pH buffers and select buffers that bracket the sample pH and are one to four pH units apart.

Prepare the pH electrode according to the instructions in the electrode user manual. Connect the pH electrode and any other electrodes to be used to the module inputs on the selected channel. In the measurement mode, press the **channel** key until the channel with the pH, pH/ISE or pH/LogR module with pH electrode connected is shown. If needed, press the **mode** key until **pH Measurement** is shown as the measure mode.

1. Press the **f1 (Cal)** key to start the calibration.
 - a. If more than one channel is displayed in the measurement mode, press the ▲ or ▼ key to highlight the desired channel and press the **f3 (Select)** key.
2. Rinse the pH electrode and any other electrodes in use with distilled water, blot dry with a lint-free tissue and place into the pH buffer.
3. When the electrode and buffer are ready, press the **f3 (Start)** key.
 - a. If using a stirrer probe, the stirrer probe will start stirring when the **f3 (Start)** key is pressed and stop stirring when the reading stabilizes.
4. Wait for the pH value on the meter to stabilize and perform one of the following actions:
 - a. Press the **f2 (Accept)** key to accept the displayed value.
or
 - b. Press the **f3 (Edit)** key and use the numeric keypad to enter the pH value. Press the **f2 (Accept)** key to confirm the entered value.
5. Press the **f2 (Next)** key to proceed to the next buffer and repeat steps 2-4 or press the **f3 (Cal Done)** key to save and end the calibration.
 - a. If a one point calibration is performed and the displayed slope needs to be edited, press the **f3 (Slope Edit)** key and press the **f3 (Clear)** key, use the numeric keypad to enter the new slope value and press the **f2 (Accept)** key.
6. The meter will display the calibration summary including the slope and export the data to the calibration log. Press the **measure (esc)** key to proceed to the measurement mode.

pH Calibration Editing

Once the **f3 (Cal Done)** key is pressed and the calibration is saved, press the **f2 (Cal Edit)** key to edit the calibration data and fix individual points without a full recalibration. In the calibration edit mode, press the ▲ or ▼ key to highlight a calibration point and press the **f2 (Delete)** key to delete the point or press the **f3 (Re-Measure)** key to re-measure the point. Follow the onscreen text prompts and instructions to edit the selected calibration point.

Example pH Calibration Displays

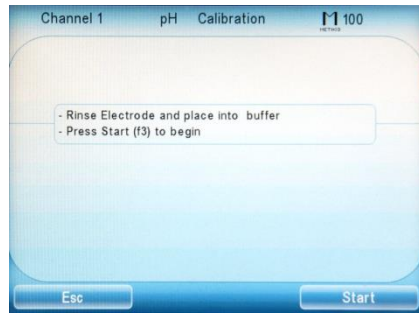

Example 1: When a pH calibration is started, onscreen text prompts provide instructions for how to perform each calibration step.

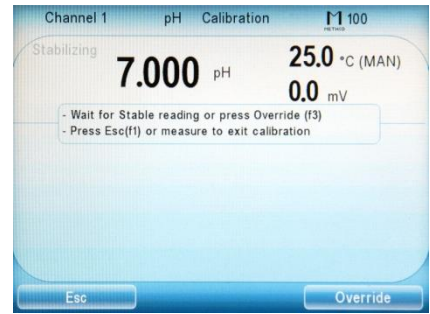

Example 2: A flashing **Stabilizing** icon is shown on the display as the pH buffer reading fluctuates and becomes stable.

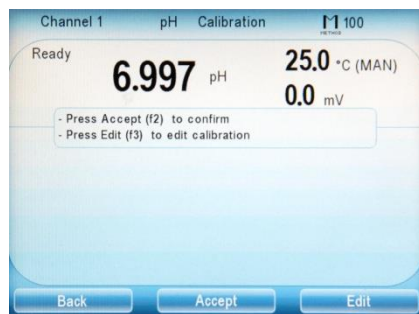

Example 3: When the pH buffer reading is stable, onscreen text prompts and function keys update with the appropriate instructions and options.

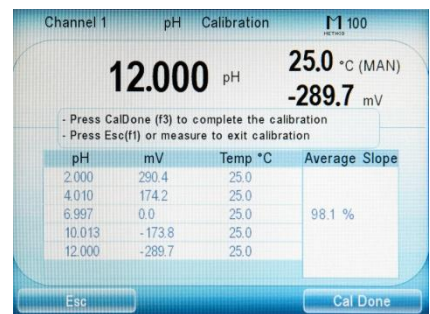

Example 4: While each pH buffer is being read, the display shows the previous calibration points with corresponding mV and temperature values.

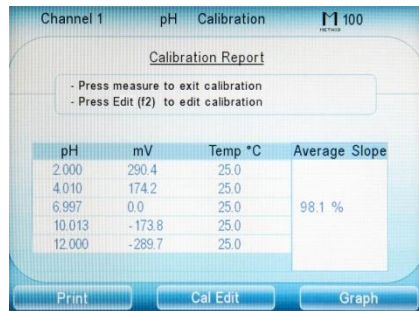

Example 5: Once the pH calibration is complete, the calibration summary is shown on the display.

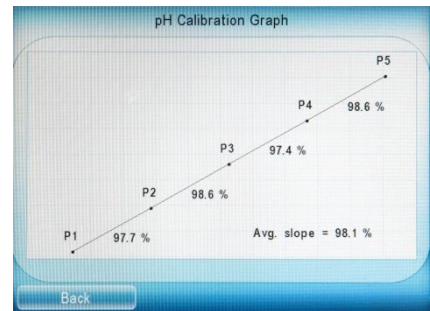

Example 6: The calibration summary can also be viewed as a graph.

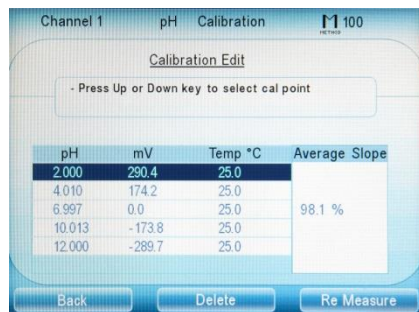

Example 7: The calibration edit function can be used to edit calibration data and fix individual points without performing a full recalibration.

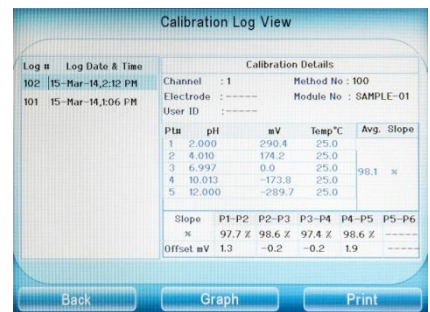

Example 8: The calibration summaries for the ten most recent calibrations per parameter can be viewed and printed in the calibration log.

Relative mV Calibration

One standard can be used for relative mV calibration. Always use fresh standard for calibration.

Prepare the electrode according to the instructions in the electrode user manual. Connect the electrode and any other electrodes to be used to the module inputs on the selected channel.

In the measurement mode, press the **channel** key until the channel with the pH, pH/ISE or pH/LogR module with electrode connected is shown. If needed, press the **mode** key until **RmV Measurement** is shown as the measure mode.

1. Press the **f1 (Cal)** key to start the calibration.
 - a. If more than one channel is displayed in the measurement mode, press the ▲ or ▼ key to highlight the desired channel and press the **f3 (Select)** key.
2. Rinse the electrode and any other electrodes in use with distilled water, blot dry with a lint-free tissue and place into the standard.
3. When the electrode and standard are ready, press the **f3 (Start)** key.
 - a. If using a stirrer probe, the stirrer probe will start stirring when the **f3 (Start)** key is pressed and stop stirring when the reading stabilizes.
4. Wait for the mV value on the meter to stabilize and perform one of the following actions:
 - a. Press the **f2 (Accept)** key to accept the displayed value.
or
 - b. Press the **f3 (Edit)** key and use the **f3 (Clear)** key and numeric keypad to enter the relative mV value. Press the **f2 (Accept)** key to confirm the entered value.
5. The meter will display the calibration summary including the mV offset. Press the **f3 (Cal Done)** key to save the calibration and export the data to the calibration log. Press the **measure (esc)** key to proceed to the measurement mode.

ORP Calibration

Versa Star Pro meters with pH, pH/ISE or pH/LogR modules offer a simple, automatic calibration to the E_H value (relative to the Standard Hydrogen Electrode, 420 mV at 25°C) in the ORP mode when using the following items:

- Thermo Scientific Orion ORP standard (Catalog Number 967901 or 967961)
- Thermo Scientific Orion ORP electrode (Catalog Number 9678BNWP, 9778BNWP, 9180BNMD or 9179BNMD)
- Thermo Scientific Orion 4 M KCl filling solution (Catalog Number 900011) or 4 M KCl gel (in the 9179BNMD electrode)

Orion ORP standard is nonhazardous, stable and will not change over time, so it is an ideal standard for any ORP measurement system. One ORP standard can be used for calibration. Always use fresh ORP standard. Prepare the ORP electrode according to the instructions in the electrode user manual. Connect the ORP electrode and any other electrodes to be used to the module inputs on the selected channel.

In the measurement mode, press the **channel** key until the channel with the pH, pH/ISE or pH/LogR module with ORP electrode connected is shown. If needed, press the **mode** key until **ORP Measurement** is shown as the measure mode.

1. Press the **f1 (Cal)** key to start the calibration.
 - a. If more than one channel is displayed in the measurement mode, press the **▲** or **▼** key to highlight the desired channel and press the **f3 (Select)** key.
2. Rinse the ORP electrode and any other electrodes in use with distilled water, blot dry with a lint-free tissue and place into the standard.
3. When the electrode and standard are ready, press the **f3 (Start)** key.
 - a. If using a stirrer probe, the stirrer probe will start stirring when the **f3 (Start)** key is pressed and stop stirring when the reading stabilizes.
4. Wait for the mV value on the meter to stabilize, indicated by the flashing **stabilizing** or solid **Ready** icons. When the solid **Ready** icon appears, press the **f2 (Accept)** key to confirm the ORP standard value.
5. The meter will display the calibration summary including the mV offset. Press the **f3 (Cal Done)** key to save the calibration and then press the **measure (esc)** key to return to measurement mode.

ISE Calibration (pH/ISE Module Only)

One to six standards can be used for ISE (ion selective electrode) calibration. If more than one standard is used for calibration, start with the lowest concentration standard and work up to the highest concentration standard last. Always use fresh standards. Select standards that bracket the sample concentration and are one decade (10 times) apart in concentration. To accurately prepare calibration standards from a stock solution, serial dilution is recommended using calibrated pipettes. If ISA will be added to samples, the same ISA must be added to all standards prior to calibration to ensure a consistent dilution factor.

Prepare the ISE according to the instructions in the electrode user manual. Connect the ISE and any other electrodes to be used to the module inputs on the selected channel. In the measurement mode, press the **channel** key until the channel with the pH/ISE module with ISE connected is shown. If needed, press the **mode** key until **ISE Measurement** is shown as the measure mode and use the [ISE Mode Menu](#) to set the Electrode Type.

1. Press the **f1 (Cal)** key to start the calibration.
 - a. If more than one channel is displayed in the measurement mode, press the ▲ or ▼ key to highlight the desired channel and press the **f3 (Select)** key.
2. Rinse the ISE and any other electrodes in use with distilled water or rinse solution required for that electrode. Blot the electrode dry with a lint-free tissue or shake the electrode and then place into the standard. Do not wipe or rub the sensing element of the electrode. Follow all electrode rinsing and drying instructions or exceptions in the ISE user manual.
3. When the electrode and standard are ready, press the **f3 (Start)** key.
 - a. If using a stirrer probe, the stirrer probe will start stirring when the **f3 (Start)** key is pressed and stop stirring when the reading stabilizes.
4. Wait for the concentration value to stabilize and perform one of the following actions:
 - a. Press the **f2 (Accept)** key to accept the displayed value.
or
 - b. Press the **f3 (Edit)** key and use the numeric keypad to enter the concentration value. Press the **f2 (Accept)** key to confirm the entered value.
5. Press the **f2 (Next)** key to proceed to the next standard and repeat steps 2-4 or press the **f3 (Cal Done)** key to save and end the calibration.
6. The meter will display the calibration summary including the slope and export the data to the calibration log. Press the **measure (esc)** key to proceed to the measurement mode.

ISE Calibration Editing

Once the **f3 (Cal Done)** key is pressed and the calibration is saved, press the **f2 (Cal Edit)** key to edit the calibration data and fix individual points without a full recalibration. In the calibration edit mode, press the ▲ or ▼ key to highlight a calibration point and press the **f2 (Delete)** key to delete the point or press the **f3 (Re-Measure)** key to re-measure the point. Follow the onscreen text prompts and instructions to edit the selected calibration point.

Temperature Calibration

Versa Star Pro meters have a relative temperature accuracy of $\pm 0.1^{\circ}\text{C}$. ATC temperature probes have varying relative accuracies, usually $\pm 0.5^{\circ}\text{C}$ to $\pm 2^{\circ}\text{C}$. Use the temperature calibration function only when necessary. Since the temperature offset calculated during the calibration is applied to all future temperature measurements, recalibrate the temperature if a different ATC temperature probe is used.

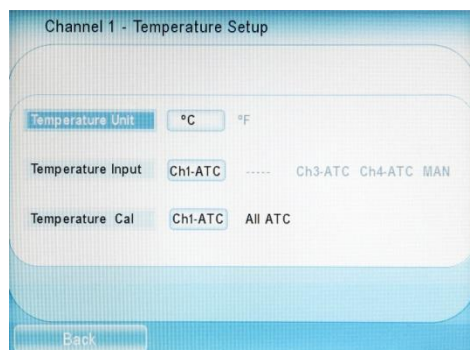

ATC Probe Temperature Calibration

ATC (Automatic Temperature Compensation) probes are defined as both separate temperature probes and those built into electrodes. A temperature calibration can be performed for individual ATC probes or simultaneously for all ATC probes connected to the meter. Prepare and connect all ATC probes to be calibrated to the appropriate module inputs on the selected channels.

1. In the measurement mode, press the **setup** key.
2. Press the **▲**, **▼**, **◀** or **▶** key to highlight Channel 1, Channel 2, Channel 3 or Channel 4 and press the **f3 (Select)** key.
 - a. Select the appropriate channel number that the ATC probe of interest is connected.
3. Press the **◀** or **▶** key to highlight Temperature and press the **f3 (Select)** key.
4. Press the **▲** or **▼** key to highlight Temperature Input and press the **◀** or **▶** key to highlight an ATC probe (i.e. Ch2-ATC) as the temperature source for the selected channel.
5. Press the **▲** or **▼** key to highlight Temperature Cal and press the **◀** or **▶** key to highlight the individual ATC probe (i.e. Ch2-ATC) or All ATC and press the **f3 (Select)** key.
6. Place the ATC probes into a solution with a known, stable temperature. It is recommended that two NIST-traceable thermometers be used to measure and verify the temperature.
7. Press the **f3 (Edit)** key, use the numeric keypad to enter the temperature of the solution and press the **f2 (Accept)** key to save the temperature value and update the offset.
8. If applicable, press the **▲** or **▼** key to highlight the reference temperature of the next ATC probe and repeat steps 6-7 for each ATC probe connected to the meter.
9. Once all ATC probes are calibrated, press the **f1 (Back)** key to exit the calibration.

Manual Temperature Entry

A manual temperature value can be entered when MAN is selected as the temperature input.

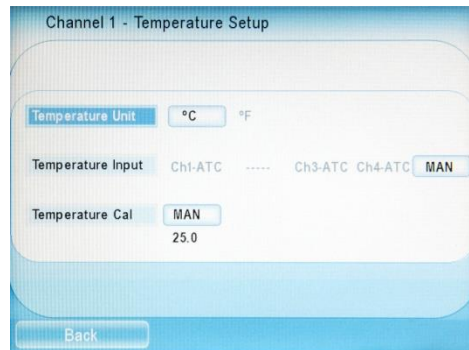

1. In the measurement mode, press the **setup** key.
2. Press the ▲, ▼, ◀ or ▶ key to highlight Channel 1, Channel 2, Channel 3 or Channel 4 and press the **f3 (Select)** key.
 - a. Select the appropriate channel number that the manual temperature will be applied.
3. Press the ◀ or ▶ key to highlight Temperature and press the **f3 (Select)** key.
4. If needed, press the ▲ or ▼ key to highlight Temperature Input and press the ◀ or ▶ key to highlight MAN.
5. Press the ▲ or ▼ key to highlight Temperature Cal and press the **f3 (Select)** key.
6. Press the **f3 (Clear)** key, input the temperature value using the numeric keypad and then press the **f2 (Enter)** key to save the value.

LogR Temperature Calibration (pH/LogR Module Only)

The Versa Star Pro meter with pH/LogR measurement module offers the option for temperature calibration of a pH electrode, allowing most standard glass-bulb pH electrodes to be used for automatic temperature compensation. The type and quality of pH electrode used to perform LogR temperature measurements will contribute to the overall temperature accuracy of the system. To maximize LogR performance and accuracy, a Thermo Scientific™ Orion™ ROSS Ultra™ or Thermo Scientific™ Orion™ ROSS™ pH electrode is recommended.

LogR technology is based on using the electrical resistance of a pH electrode's pH-sensing glass-bulb as the temperature source. The logarithm of the resistance of the bulb varies almost linearly with the reciprocal of the absolute temperature. Almost all standard glass-bulb pH electrodes exhibit a similar decrease in resistance with increasing temperature.

LogR Temperature Calibration Recommendations

- When using the meter for the first time or restarting the meter in the LogR temperature mode, a LogR temperature calibration must be performed. A LogR temperature calibration should be performed at least once per week to ensure accurate temperature compensation when using the LogR temperature mode. Recalibrate the LogR temperature if the meter is disconnected from the power supply or the pH electrode is disconnected from the meter.
- Up to a three point LogR temperature calibration can be performed. It is recommended that at least two calibration points be used to meet optimum system accuracy.
- Choose a temperature calibration range that is 5°C to 20°C apart, depending on the expected sample temperature range, and evenly bracket the expected temperature range. For example, if sample temperatures are around 25°C, calibrate at 15°C and 35°C. For sample temperatures that differ by more than 20°C, a three point LogR temperature calibration is recommended. For many samples, a one point LogR calibration near the expected sample temperature will yield adequate results.
- A constant temperature bath or a hot plate is recommended to hold the temperature of the calibrating solution.
- For best results during temperature calibration, it is recommended that a pH buffer or tap water be used as the temperature calibrating solution. Do not use distilled water because the conductivity is too low to obtain a good temperature calibration.
- LogR temperature calibration can be performed using a NIST-traceable thermometer or ATC probe. The most accurate method is to use a NIST-traceable thermometer. It is recommended that two NIST-traceable thermometers be used to measure and verify the temperature value. The fastest method is to use an ATC probe. If an ATC probe is connected with the pH/LogR module when a LogR temperature calibration is performed, the meter will import the temperature value from the ATC probe as the reference temperature during the calibration. The temperature source used to perform the LogR temperature calibration will contribute to the overall temperature accuracy of the system.

Detailed information on this feature is available in the [Appendix](#) section of this user manual.

LogR Temperature Calibration Procedure

Prepare the glass-bulb pH electrode according to the instructions in the electrode user manual. Connect the pH electrode to the pH/LogR module input on the selected channel. If an ATC probe will be used as the temperature source, prepare and connect the ATC probe to the pH/LogR module input on the same channel. Use a constant temperature bath or a hot plate to attain the desired temperatures of the calibration solutions.

1. In the measurement mode, press the **setup** key.
2. Press the ▲, ▼, ◀ or ▶ key to highlight Channel 1, Channel 2, Channel 3 or Channel 4 and press the **f3 (Select)** key.
 - a. Select the appropriate channel number that the pH/LogR module is connected.
3. Press the ◀ or ▶ key to highlight Temperature and press the **f3 (Select)** key.
4. Press the ▲ or ▼ key to highlight Temperature Input and press the ◀ or ▶ key to highlight the pH electrode that will be used for the LogR mode (i.e. Ch2-LogR).
 - This enables the LogR mode for the selected channel and allows a LogR temperature calibration to be performed.
5. Press the ▲ or ▼ key to highlight Temperature Cal and press the **f3 (Select)** key.
6. Place the pH electrode and NIST-traceable thermometers or ATC probe into a calibration solution (pH buffer or tap water) with a known, stable temperature. Moderately stir the solution using an Orion Star stirrer probe (Catalog Number 096019) or stir plate with stir bar.
7. Press the **f3 (Start)** key and wait for the temperature value on the meter to stabilize.
 - a. If using a stirrer probe, the stirrer probe will start stirring when the **f3 (Start)** key is pressed and stop stirring when the reading stabilizes.
8. Once the temperature value is stable, perform one of the following actions:
 - a. Press the **f2 (Accept)** key to accept the displayed value.
or
 - b. Press the **f3 (Edit)** key, press the **f3 (Clear)** key, use the numeric keypad to enter the temperature value and press the **f2 (Accept)** key to confirm the entered value.
9. Press the **f2 (Next)** key to proceed to the next calibration point and repeat steps 6-8 or press the **f3 (Cal Done)** key to save and end the calibration.

Incremental Techniques (pH/ISE Module Only)

The Versa Star Pro meter with pH/ISE measurement module offers the option for incremental techniques when in the ISE measure mode. Preset methods for single known addition, single known subtraction, double known addition, double known subtraction, single analate addition and single analate subtraction are available.

- When performing incremental techniques, the sample concentration must be known within an order of magnitude so the increment may be correctly chosen and the sample and standard must be volumetrically determined.
- It is very important that any complexing agent is present in excess (at least 50 to 100 times) or not at all. The ratio of free to complexed ions must remain constant over the addition. An indication that a complexing agent is present, but not in great enough quantity to maintain a constant free ion to complexed ion ratio, is an abnormally high or low slope. If this is a suspected problem, add an excess amount of complexing or decomplexing agent to the original solution in the beaker.
- Electrode interferences should be at a minimum, since the effect of the interference might change as the concentration of the ion of interest changes. This situation may also result in high or low electrode slopes. Consult the electrode user manual for information on reducing or eliminating some electrode interferences.
- Known addition is a useful method for measuring dilute samples, occasional samples or samples that contain an excess of complexing agent. Known addition can also be used to verify the results of a direct measurement.
- Known subtraction is useful when measuring ions for which stable standards do not exist. Known subtraction can also be used as a quick version of a titration. When performing a known subtraction, it is necessary to know the stoichiometric ratio between the standard and sample.
- Double incremental techniques calculate the electrode slope and sample concentration simultaneously. The electrode slope is determined directly in the sample, which results in greater accuracy for samples with complex matrices and greater analysis speed.
- The Electrode Type must be set for the Ion Selective Electrode (ISE) that will be used for the analysis, since the selected Electrode Type determines the expected slope range and slope direction (positive or negative). The Electrode Type is set using the [ISE Mode Menu](#).



Single Known Addition

In known addition, a standard of known concentration is added to a sample of unknown concentration. The total concentration should approximately double upon the addition of the standard, therefore sample concentration should be known within an order of magnitude. Refer to the following table to choose the correct standard concentration and volume of addition.

Amount of standard to be added per 100 mL of sample	Standard concentration compared to expected sample concentration
1 mL	100 times more concentrated
5 mL	20 times more concentrated
10 mL	10 times more concentrated

1. Prepare the ion selective electrode (ISE) according to the instructions in the electrode user manual. Prepare all required solutions (ionic strength adjusters, standards, etc) and review any special requirements outlined in the electrode user manual. Connect the ISE, and any other electrodes to be used, to the module inputs on the selected channel.
2. Determine the ISE slope as directed in the electrode user manual.
3. In the measurement mode, press the **channel** key until the channel with the pH/ISE module with ISE connected is shown. If needed, press the **mode** key until **ISE Measurement** is shown as the measure mode and use the [ISE Mode Menu](#) to set the Electrode Type.
4. In the measurement mode, press the **setup** key.
5. Press the **▲**, **▼**, **◀** or **▶** key to highlight [Channel 1](#), [Channel 2](#), [Channel 3](#) or [Channel 4](#) and press the **f3 (Select)** key.
 - a. Select the appropriate channel number that the ISE is connected.
6. Press the **◀** or **▶** key to highlight [Incremental Techniques](#) and press the **f3 (Select)** key.
7. Press the **▲** or **▼** key to highlight [Single Known Addition](#) and press the **f3 (Select)** key.
8. Press the **f3 (Clear)** key as needed to delete the displayed slope value. Use the numeric keypad to enter the ISE slope value determined in step 2 and press the **f2 (Accept)** key.
9. Enter the sample volume using the numeric keypad and press the **f2 (Accept)** key.
10. Enter the total volume (sample volume plus added ISA volume) using the numeric keypad and press the **f2 (Accept)** key.
11. Enter the standard concentration using the numeric keypad and press the **f2 (Accept)** key.
12. Rinse the ISE and any other electrodes in use with distilled water or rinse solution required for that electrode. Blot the electrode dry with a lint-free tissue or shake the electrode, place into the prepared sample and press the **f2 (Next)** key.

- a. Follow all electrode rinsing and drying instructions or exceptions in the ISE user manual. Do not wipe or rub the sensing element of the electrode.
13. Wait for the mV value on the meter to stabilize and press the **f2 (Accept)** key.
14. Enter the standard volume using the numeric keypad and press the **f2 (Accept)** key.
15. Add the standard to the sample and press the **f2 (Yes)** key.
16. Wait for the mV value on the meter to stabilize and press the **f2 (Accept)** key.
17. The meter will display the calculated sample concentration and summary of the incremental technique performed. Press the **f1 (Esc)** key to proceed to the measurement mode or press the **f2 (Next)** key to perform another analysis.

Saving the Incremental Technique as a Method

For frequently used incremental techniques, Versa Star Pro meters now allow individual incremental techniques to be stored as methods.

1. In the measurement mode, press the **setup** key.
2. Press the **▲, ▼, ◀ or ▶** key to highlight Channel 1, Channel 2, Channel 3 or Channel 4 and press the **f3 (Select)** key.
3. Press the **◀ or ▶** key to highlight Method and press the **f3 (Select)** key.
4. Press the **▲ or ▼** key to highlight Edit / Create and press the **f3 (Select)** key.
5. Press the **▲ or ▼** key to highlight a new method and press the **f3 (Edit)** key.
6. Press the **◀ or ▶** key to highlight Inc. Tech and press the **f3 (Select)** key.
7. Press the **▲ or ▼** key to highlight Single Known Addition and press the **f3 (Select)** key.
8. Press the **▲ or ▼** key to highlight a value and press the **f3 (Edit)** key. Use the meter's numeric keypad to enter the value and press the **f2 (Accept)** key. Repeat for all values.
9. Once all the values for Single Known Addition have been entered, press the **f2 (Save)** key.
10. The meter will display the ISE measure mode setup menu. Review and update the measurement parameters for the method and then press the **f1 (Back)** key.
11. Press the **▲ or ▼** key to highlight Load from the main method menu and press the **f3 (Select)** key.
12. Press the **▲ or ▼** key to highlight the ISE method for Single Known Addition and press the **f3 (Load)** key. The meter will return to the measurement mode with the method loaded.

Double Known Addition

Double Known Addition Recommendations

The sample volume should be 100 mL.

The concentration of the standard should be 100 times the expected sample concentration.

The volume of the first addition should be 1 mL and the volume of the second addition should be 10 mL.

1. Prepare the ion selective electrode (ISE) according to the instructions in the electrode user manual. Prepare all required solutions (ionic strength adjusters, standards, etc) and review any special requirements outlined in the electrode user manual. Connect the ISE, and any other electrodes to be used, to the module inputs on the selected channel.
2. In the measurement mode, press the **channel** key until the channel with the pH/ISE module with ISE connected is shown. If needed, press the **mode** key until **ISE Measurement** is shown as the measure mode and use the [ISE Mode Menu](#) to set the Electrode Type.
3. In the measurement mode, press the **setup** key.
4. Press the **▲**, **▼**, **◀** or **▶** key to highlight [Channel 1](#), [Channel 2](#), [Channel 3](#) or [Channel 4](#) and press the **f3 (Select)** key.
 - a. Select the appropriate channel number that the ISE is connected.
5. Press the **◀** or **▶** key to highlight [Incremental Techniques](#) and press the **f3 (Select)** key.
6. Press the **▲** or **▼** key to highlight [Double Known Addition](#) and press the **f3 (Select)** key.
7. Enter the sample volume using the numeric keypad and press the **f2 (Accept)** key.
8. Enter the total volume (sample volume plus added ISA volume) using the numeric keypad and press the **f2 (Accept)** key.
9. Enter the standard concentration using the numeric keypad and press the **f2 (Accept)** key.
10. Rinse the ISE and any other electrodes in use with distilled water or rinse solution required for that electrode. Blot the electrode dry with a lint-free tissue or shake the electrode, place into the prepared sample and press the **f2 (Next)** key.
 - a. Follow all electrode rinsing and drying instructions or exceptions in the ISE user manual. Do not wipe or rub the sensing element of the electrode.
11. Wait for the mV value on the meter to stabilize and press the **f2 (Accept)** key.
12. Enter the first standard volume using the numeric keypad and press the **f2 (Accept)** key.
13. Add the first specified volume of the standard to the sample and press the **f2 (Yes)** key.
14. Wait for the mV value on the meter to stabilize and press the **f2 (Accept)** key.
15. Enter the second standard volume using the numeric keypad and press the **f2 (Accept)** key.

16. Add the second specified volume of the standard to the sample and press the **f2 (Yes)** key.
17. Wait for the mV value on the meter to stabilize and press the **f2 (Accept)** key.
18. The meter will display the calculated sample concentration and summary of the incremental technique performed. Press the **f1 (Esc)** key to proceed to the measurement mode or press the **f2 (Next)** key to perform another analysis.

Saving the Incremental Technique as a Method

For frequently used incremental techniques, Versa Star Pro meters now allow individual incremental techniques to be stored as methods.

1. In the measurement mode, press the **setup** key.
2. Press the ▲, ▼, ◀ or ▶ key to highlight Channel 1, Channel 2, Channel 3 or Channel 4 and press the **f3 (Select)** key.
3. Press the ◀ or ▶ key to highlight Method and press the **f3 (Select)** key.
4. Press the ▲ or ▼ key to highlight Edit / Create and press the **f3 (Select)** key.
5. Press the ▲ or ▼ key to highlight a new method and press the **f3 (Edit)** key.
6. Press the ◀ or ▶ key to highlight Inc. Tech and press the **f3 (Select)** key.
7. Press the ▲ or ▼ key to highlight Double Known Addition and press the **f3 (Select)** key.
8. Press the ▲ or ▼ key to highlight a value and press the **f3 (Edit)** key. Use the meter's numeric keypad to enter the value and press the **f2 (Accept)** key. Repeat for all values.
9. Once all the values for Double Known Addition have been entered, press the **f2 (Save)** key.
10. The meter will display the ISE measure mode setup menu. Review and update the measurement parameters for the method and then press the **f1 (Back)** key.
11. Press the ▲ or ▼ key to highlight Load from the main method menu and press the **f3 (Select)** key.
12. Press the ▲ or ▼ key to highlight the ISE method for Double Known Addition and press the **f3 (Load)** key. The meter will return to the measurement mode with the method loaded.

Single Known Subtraction

In known subtraction, each addition of standard subtracts an increment of the species to be measured. Enter the reaction ratio of the measured species to the added standard. For example, if a sulfide (S^{2-}) sample will be subtracted by the addition of silver (Ag^+), two silver ions are required to subtract each sulfide ion and the reaction ratio is 0.5.

Sample concentration in Molarity or Normality should be known within an order of magnitude and the total sample concentration should be approximately halved upon addition of the standard. Concentrations are in Molarity or Normality due to the stoichiometric nature of the subtraction. Refer to the following table to choose the correct standard concentration and volume of addition.

Amount of standard to be added per 100 mL of sample	Standard concentration (in Molarity or Normality) compared to expected sample concentration
1 mL	50 times more concentrated
5 mL	10 times more concentrated
10 mL	5 times more concentrated

1. Prepare the ion selective electrode (ISE) according to the instructions in the electrode user manual. Prepare all required solutions (ionic strength adjusters, standards, etc) and review any special requirements outlined in the electrode user manual. Connect the ISE, and any other electrodes to be used, to the module inputs on the selected channel.
2. Determine the ISE slope as directed in the electrode user manual.
3. In the measurement mode, press the **channel** key until the channel with the pH/ISE module with ISE connected is shown. If needed, press the **mode** key until **ISE Measurement** is shown as the measure mode and use the [ISE Mode Menu](#) to set the Electrode Type.
4. In the measurement mode, press the **setup** key.
5. Press the **▲**, **▼**, **◀** or **▶** key to highlight [Channel 1](#), [Channel 2](#), [Channel 3](#) or [Channel 4](#) and press the **f3 (Select)** key.
 - a. Select the appropriate channel number that the ISE is connected.
6. Press the **◀** or **▶** key to highlight [Incremental Techniques](#) and press the **f3 (Select)** key.
7. Press the **▲** or **▼** key to highlight [Single Known Subtraction](#) and press the **f3 (Select)** key.
8. Press the **f3 (Clear)** key as needed to delete the displayed slope value. Use the numeric keypad to enter the ISE slope value determined in step 2 and press the **f2 (Accept)** key.
9. Enter the sample volume using the numeric keypad and press the **f2 (Accept)** key.
10. Enter the total volume (sample volume plus added ISA volume) using the numeric keypad and press the **f2 (Accept)** key.

11. Enter the standard concentration in Molarity or Normality using the numeric keypad and press the **f2 (Accept)** key.
12. Enter the reaction ratio using the numeric keypad and press the **f2 (Accept)** key.
13. Rinse the ISE and any other electrodes in use with distilled water or rinse solution required for that electrode. Blot the electrode dry with a lint-free tissue or shake the electrode, place into the prepared sample and press the **f2 (Next)** key.
 - a. Follow all electrode rinsing and drying instructions or exceptions in the ISE user manual. Do not wipe or rub the sensing element of the electrode.
14. Wait for the mV value on the meter to stabilize and press the **f2 (Accept)** key.
15. Enter the standard volume using the numeric keypad and press the **f2 (Accept)** key.
16. Add the standard to the sample and press the **f2 (Yes)** key.
17. Wait for the mV value on the meter to stabilize and press the **f2 (Accept)** key.
18. The meter will display the calculated sample concentration and summary of the incremental technique performed. Press the **f1 (Esc)** key to proceed to the measurement mode or press the **f2 (Next)** key to perform another analysis.

Saving the Incremental Technique as a Method

For frequently used incremental techniques, Versa Star Pro meters now allow individual incremental techniques to be stored as methods.

1. In the measurement mode, press the **setup** key.
2. Press the **▲, ▼, ◀** or **▶** key to highlight Channel 1, Channel 2, Channel 3 or Channel 4 and press the **f3 (Select)** key.
3. Press the **◀** or **▶** key to highlight Method and press the **f3 (Select)** key.
4. Press the **▲** or **▼** key to highlight Edit / Create and press the **f3 (Select)** key.
5. Press the **▲** or **▼** key to highlight a new method and press the **f3 (Edit)** key.
6. Press the **◀** or **▶** key to highlight Inc. Tech and press the **f3 (Select)** key.
7. Press the **▲** or **▼** key to highlight Single Known Subtraction and press the **f3 (Select)** key.
8. Press the **▲** or **▼** key to highlight a value and press the **f3 (Edit)** key. Use the meter's numeric keypad to enter the value and press the **f2 (Accept)** key. Repeat for all values.
9. Once all the values for Single Known Subtraction have been entered, press the **f2 (Save)** key.
10. The meter will display the ISE measure mode setup menu. Review and update the measurement parameters for the method and then press the **f1 (Back)** key.
11. Press the **▲** or **▼** key to highlight Load from the main method menu and press the **f3 (Select)** key.
12. Press the **▲** or **▼** key to highlight the ISE method for Single Known Subtraction and press the **f3 (Load)** key. The meter will return to the measurement mode with the method loaded.

Double Known Subtraction

Double Known Subtraction Recommendations
Ensure that the subtraction ability of the chosen standard concentration and volume added does not exceed the concentration of the sample.
The sample volume should be 100 mL.
The concentration of the standard in Molarity or Normality should be 50 times the expected sample concentration when the reaction ratio is 1.
Calculate the volume of standard required to halve the initial sample concentration and divide by six. The volume of the first addition should be 5/6 the total standard mL and the volume of the second addition should be 1/6 the total standard mL. If available, consult a printout from a previous analysis of a similar sample.

1. Prepare the ion selective electrode (ISE) according to the instructions in the electrode user manual. Prepare all required solutions (ionic strength adjusters, standards, etc) and review any special requirements outlined in the electrode user manual. Connect the ISE, and any other electrodes to be used, to the module inputs on the selected channel.
2. In the measurement mode, press the **channel** key until the channel with the pH/ISE module with ISE connected is shown. If needed, press the **mode** key until **ISE Measurement** is shown as the measure mode and use the [ISE Mode Menu](#) to set the Electrode Type.
3. In the measurement mode, press the **setup** key.
4. Press the **▲**, **▼**, **◀** or **▶** key to highlight [Channel 1](#), [Channel 2](#), [Channel 3](#) or [Channel 4](#) and press the **f3 (Select)** key.
 - a. Select the appropriate channel number that the ISE is connected.
5. Press the **◀** or **▶** key to highlight [Incremental Techniques](#) and press the **f3 (Select)** key.
6. Press the **▲** or **▼** key to highlight [Double Known Subtraction](#) and press the **f3 (Select)** key.
7. Enter the sample volume using the numeric keypad and press the **f2 (Accept)** key.
8. Enter the total volume (sample volume plus added ISA volume) using the numeric keypad and press the **f2 (Accept)** key.
9. Enter the standard concentration in Molarity or Normality using the numeric keypad and press the **f2 (Accept)** key.
10. Enter the reaction ratio using the numeric keypad and press the **f2 (Accept)** key.
11. Rinse the ISE and any other electrodes in use with distilled water or rinse solution required for that electrode. Blot the electrode dry with a lint-free tissue or shake the electrode, place into the prepared sample and press the **f2 (Next)** key.
 - a. Follow all electrode rinsing and drying instructions or exceptions in the ISE user manual. Do not wipe or rub the sensing element of the electrode.

12. Wait for the mV value on the meter to stabilize and press the **f2 (Accept)** key.
13. Enter the first standard volume using the numeric keypad and press the **f2 (Accept)** key.
14. Add the first specified volume of the standard to the sample and press the **f2 (Yes)** key.
15. Wait for the mV value on the meter to stabilize and press the **f2 (Accept)** key.
16. Enter the second standard volume using the numeric keypad and press the **f2 (Accept)** key.
17. Add the second specified volume of the standard to the sample and press the **f2 (Yes)** key.
18. Wait for the mV value on the meter to stabilize and press the **f2 (Accept)** key.
19. The meter will display the calculated sample concentration and summary of the incremental technique performed. Press the **f1 (Esc)** key to proceed to the measurement mode or press the **f2 (Next)** key to perform another analysis.

Saving the Incremental Technique as a Method

For frequently used incremental techniques, Versa Star Pro meters now allow individual incremental techniques to be stored as methods.

1. In the measurement mode, press the **setup** key.
2. Press the **▲**, **▼**, **◀** or **▶** key to highlight Channel 1, Channel 2, Channel 3 or Channel 4 and press the **f3 (Select)** key.
3. Press the **◀** or **▶** key to highlight Method and press the **f3 (Select)** key.
4. Press the **▲** or **▼** key to highlight Edit / Create and press the **f3 (Select)** key.
5. Press the **▲** or **▼** key to highlight a new method and press the **f3 (Edit)** key.
6. Press the **◀** or **▶** key to highlight Inc. Tech and press the **f3 (Select)** key.
7. Press the **▲** or **▼** key to highlight Double Known Subtraction and press the **f3 (Select)** key.
8. Press the **▲** or **▼** key to highlight a value and press the **f3 (Edit)** key. Use the meter's numeric keypad to enter the value and press the **f2 (Accept)** key. Repeat for all values.
9. Once all the values for Double Known Subtraction have been entered, press the **f2 (Save)** key.
10. The meter will display the ISE measure mode setup menu. Review and update the measurement parameters for the method and then press the **f1 (Back)** key.
11. Press the **▲** or **▼** key to highlight Load from the main method menu and press the **f3 (Select)** key.
12. Press the **▲** or **▼** key to highlight the ISE method for Double Known Subtraction and press the **f3 (Load)** key. The meter will return to the measurement mode with the method loaded.

Single Analate Addition

In single analate addition, the first measurement is in a known standard solution containing the same type of analate of interest as the sample. The second measurement follows the addition of the unknown sample. The concentration of the unknown sample is then calculated. Refer to the following table to choose the correct standard concentration and volume of addition.

Amount of analate to be added per 100 mL of standard	Standard concentration compared to expected sample concentration
1 mL	100 times more concentrated
5 mL	20 times more concentrated
10 mL	10 times more concentrated

1. Prepare the ion selective electrode (ISE) according to the instructions in the electrode user manual. Prepare all required solutions (ionic strength adjusters, standards, etc) and review any special requirements outlined in the electrode user manual. Connect the ISE, and any other electrodes to be used, to the module inputs on the selected channel.
2. Determine the ISE slope as directed in the electrode user manual.
3. In the measurement mode, press the **channel** key until the channel with the pH/ISE module with ISE connected is shown. If needed, press the **mode** key until **ISE Measurement** is shown as the measure mode and use the [ISE Mode Menu](#) to set the Electrode Type.
4. In the measurement mode, press the **setup** key.
5. Press the ▲, ▼, ◀ or ▶ key to highlight [Channel 1](#), [Channel 2](#), [Channel 3](#) or [Channel 4](#) and press the **f3 (Select)** key.
 - a. Select the appropriate channel number that the ISE is connected.
6. Press the ◀ or ▶ key to highlight [Incremental Techniques](#) and press the **f3 (Select)** key.
7. Press the ▲ or ▼ key to highlight [Single Analate Addition](#) and press the **f3 (Select)** key.
8. Press the **f3 (Clear)** key as needed to delete the displayed slope value. Use the numeric keypad to enter the ISE slope value determined in step 2 and press the **f2 (Accept)** key.
9. Enter the standard volume using the numeric keypad and press the **f2 (Accept)** key.
10. Enter the total volume (standard volume plus added ISA volume) using the numeric keypad and press the **f2 (Accept)** key.
11. Enter the standard concentration using the numeric keypad and press the **f2 (Accept)** key.
12. Rinse the ISE and any other electrodes in use with distilled water or rinse solution required for that electrode. Blot the electrode dry with a lint-free tissue or shake the electrode, place into the prepared standard and press the **f2 (Next)** key.

- a. Follow all electrode rinsing and drying instructions or exceptions in the ISE user manual. Do not wipe or rub the sensing element of the electrode.
13. Wait for the mV value on the meter to stabilize and press the **f2 (Accept)** key.
14. Enter the analate/sample volume using the numeric keypad and press the **f2 (Accept)** key.
15. Add the analate/sample to the standard and press the **f2 (Yes)** key.
16. Wait for the mV value on the meter to stabilize and press the **f2 (Accept)** key.
17. The meter will display the calculated sample concentration and summary of the incremental technique performed. Press the **f1 (Esc)** key to proceed to the measurement mode or press the **f2 (Next)** key to perform another analysis.

Saving the Incremental Technique as a Method

For frequently used incremental techniques, Versa Star Pro meters now allow individual incremental techniques to be stored as methods.

1. In the measurement mode, press the **setup** key.
2. Press the **▲, ▼, ◀ or ▶** key to highlight Channel 1, Channel 2, Channel 3 or Channel 4 and press the **f3 (Select)** key.
3. Press the **◀ or ▶** key to highlight Method and press the **f3 (Select)** key.
4. Press the **▲ or ▼** key to highlight Edit / Create and press the **f3 (Select)** key.
5. Press the **▲ or ▼** key to highlight a new method and press the **f3 (Edit)** key.
6. Press the **◀ or ▶** key to highlight Inc. Tech and press the **f3 (Select)** key.
7. Press the **▲ or ▼** key to highlight Single Analate Addition and press the **f3 (Select)** key.
8. Press the **▲ or ▼** key to highlight a value and press the **f3 (Edit)** key. Use the meter's numeric keypad to enter the value and press the **f2 (Accept)** key. Repeat for all values.
9. Once all the values for Single Analate Addition have been entered, press the **f2 (Save)** key.
10. The meter will display the ISE measure mode setup menu. Review and update the measurement parameters for the method and then press the **f1 (Back)** key.
11. Press the **▲ or ▼** key to highlight Load from the main method menu and press the **f3 (Select)** key.
12. Press the **▲ or ▼** key to highlight the ISE method for Single Analate Addition and press the **f3 (Load)** key. The meter will return to the measurement mode with the method loaded.

Single Analate Subtraction

In single analate subtraction, the first measurement uses known standard solution containing the type of ions that the ISE can measure and that will complex with the analate of interest in the unknown sample. The second measurement follows the addition of the unknown sample that reduces the concentration of the ions in the measurement solution. The concentration of the analate in interest in the unknown is then calculated. Concentrations are in Molarity or Normality due to the stoichiometric nature of the subtraction.

Analate Subtraction Recommendations
Ensure the subtraction ability of the analate/sample concentration and volume added does not exceed the concentration of the chosen standard.
A convenient standard volume is 100 mL.
The analate/sample may be added by volume only. A volume of 1 mL usually works.
The standard solution to which additions are made should be approximately 1/50 the expected sample concentration.

1. Prepare the ion selective electrode (ISE) according to the instructions in the electrode user manual. Prepare all required solutions (ionic strength adjusters, standards, etc) and review any special requirements outlined in the electrode user manual. Connect the ISE, and any other electrodes to be used, to the module inputs on the selected channel.
2. Determine the ISE slope as directed in the electrode user manual.
3. In the measurement mode, press the **channel** key until the channel with the pH/ISE module with ISE connected is shown. If needed, press the **mode** key until **ISE Measurement** is shown as the measure mode and use the [ISE Mode Menu](#) to set the Electrode Type.
4. In the measurement mode, press the **setup** key.
5. Press the **▲**, **▼**, **◀** or **▶** key to highlight [Channel 1](#), [Channel 2](#), [Channel 3](#) or [Channel 4](#) and press the **f3 (Select)** key.
 - a. Select the appropriate channel number that the ISE is connected.
6. Press the **◀** or **▶** key to highlight [Incremental Techniques](#) and press the **f3 (Select)** key.
7. Press the **▲** or **▼** key to highlight [Single Analate Subtraction](#) and press the **f3 (Select)** key.
8. Press the **f3 (Clear)** key as needed to delete the displayed slope value. Use the numeric keypad to enter the ISE slope value determined in step 2 and press the **f2 (Accept)** key.
9. Enter the standard volume using the numeric keypad and press the **f2 (Accept)** key.
10. Enter the total volume (standard volume plus added ISA volume) using the numeric keypad and press the **f2 (Accept)** key.
11. Enter the standard concentration using the numeric keypad and press the **f2 (Accept)** key.

12. Enter the reaction ratio using the numeric keypad and press the **f2 (Accept)** key.
13. Rinse the ISE and any other electrodes in use with distilled water or rinse solution required for that electrode. Blot the electrode dry with a lint-free tissue or shake the electrode, place into the prepared standard and press the **f2 (Next)** key.
 - a. Follow all electrode rinsing and drying instructions or exceptions in the ISE user manual. Do not wipe or rub the sensing element of the electrode.
14. Wait for the mV value on the meter to stabilize and press the **f2 (Accept)** key.
15. Enter the analate/sample volume using the numeric keypad and press the **f2 (Accept)** key.
16. Add the analate/sample to the standard and press the **f2 (Yes)** key.
17. Wait for the mV value on the meter to stabilize and press the **f2 (Accept)** key.
18. The meter will display the calculated sample concentration and summary of the incremental technique performed. Press the **f1 (Esc)** key to proceed to the measurement mode or press the **f2 (Next)** key to perform another analysis.

Saving the Incremental Technique as a Method

For frequently used incremental techniques, Versa Star Pro meters now allow individual incremental techniques to be stored as methods.

1. In the measurement mode, press the **setup** key.
2. Press the **▲, ▼, ◀ or ▶** key to highlight Channel 1, Channel 2, Channel 3 or Channel 4 and press the **f3 (Select)** key.
3. Press the **◀ or ▶** key to highlight Method and press the **f3 (Select)** key.
4. Press the **▲ or ▼** key to highlight Edit / Create and press the **f3 (Select)** key.
5. Press the **▲ or ▼** key to highlight a new method and press the **f3 (Edit)** key.
6. Press the **◀ or ▶** key to highlight Inc. Tech and press the **f3 (Select)** key.
7. Press the **▲ or ▼** key to highlight Single Analate Subtraction and press the **f3 (Select)** key.
8. Press the **▲ or ▼** key to highlight a value and press the **f3 (Edit)** key. Use the meter's numeric keypad to enter the value and press the **f2 (Accept)** key. Repeat for all values.
9. Once all the values for Single Analate Subtraction have been entered, press the **f2 (Save)** key.
10. The meter will display the ISE measure mode setup menu. Review and update the measurement parameters for the method and then press the **f1 (Back)** key.
11. Press the **▲ or ▼** key to highlight Load from the main method menu and press the **f3 (Select)** key.
12. Press the **▲ or ▼** key to highlight the ISE method for Single Analate Subtraction and press the **f3 (Load)** key. The meter will return to the measurement mode with the method loaded.

5

Chapter 5 **Conductivity Measurement Module**

Connecting Electrodes to the Module

To begin using the Versa Star Pro meter and module system, prepare the meter and insert the module into an available channel on the back of the meter. See [Chapter 2 Meter Basics](#) for instructions. For information on customizing meter settings, refer to [Chapter 3 Setup Menu](#).

- It is recommended that electrodes be placed in the meter-attached electrode stand for easy movement in and out of beakers during calibration, sample measurement and storage.

VSTAR-CND Versa Star Conductivity Module

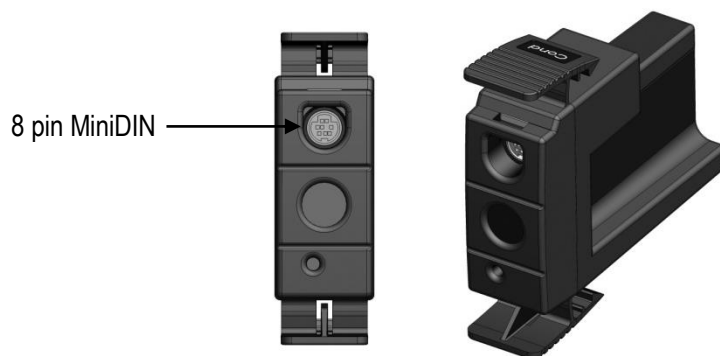

1. Connect a conductivity probe to the 8 pin MiniDIN connector on the module. If the conductivity probe has a built-in temperature probe, the temperature will also be measured when the conductivity probe is connected.
2. Prepare the conductivity probe for use as instructed in the probe user manual.

Channel 1-4 Setup Menus

Mode Menus for Conductivity, TDS, Salinity and Resistivity

Within the Channel 1, Channel 2, Channel 3 and Channel 4 setup menus are Method, Mode and Temperature submenus, which can be used to customize measurement settings and parameters for the selected channel. This section provides detailed information on the Mode menus for each measurement parameter available when using a conductivity module.

1. In the measurement mode, press the **setup** key.
2. Press the ▲, ▼, ◀ or ▶ key to highlight Channel 1, Channel 2, Channel 3 or Channel 4 and press the **f3 (Select)** key.
 - a. Select the appropriate channel number that the module of interest is connected.
3. Press the ◀ or ▶ key to highlight Mode and press the **f3 (Select)** key.

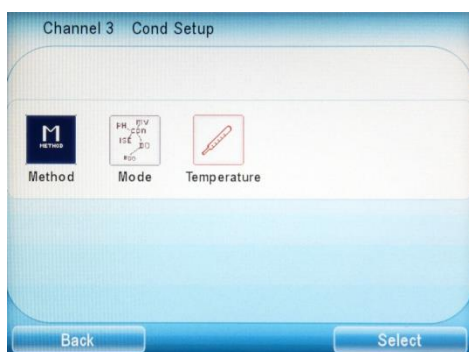

4. Press the ▲ or ▼ key to highlight Conductivity, TDS, Salinity or Resistivity and press the **f3 (Select)** key.

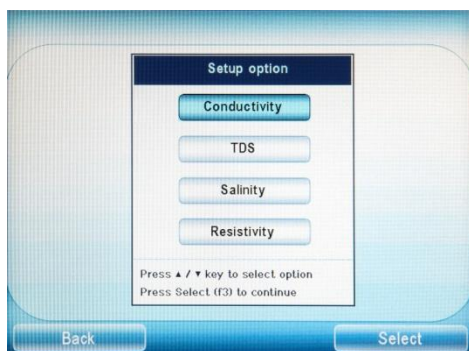

5. Press the ▲ or ▼ key to highlight a menu option and press the ◀ or ▶ key to highlight a submenu option. Onscreen text prompts provide instructions for changing parameters within a selected menu option.



- a. Use the popup alphanumeric keypad screen for menu options including Electrode Serial Number and Sample ID.
 - i. Press the ▲, ▼, ◀ or ▶ key to highlight a character, press the **f2 (Enter)** key to input the character and repeat until the desired name is entered.
 - ii. Press the **f3 (Clear)** key to delete any undesired characters.

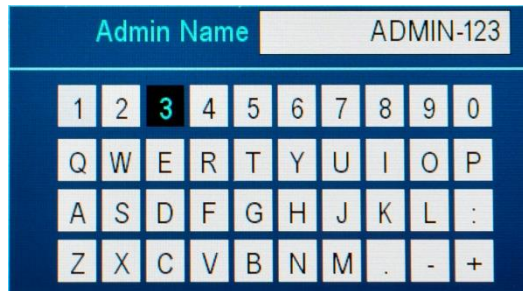

- iii. Press the **f1 (Done)** key to save the entry.

Conductivity Mode Menu



Main Menu	Settings	Details
Read Type	Auto-Read , Timed, Single-Shot, Continuous	For Timed and Single-Shot, set the time in hours, minutes, seconds using the arrow keys
Cell K	0.475	Enter the nominal cell constant (K) value of the conductivity probe, value is used when performing an automatic conductivity calibration
Ref. Temperature	5°C, 10°C, 15°C, 20°C, 25°C	Set the reference temperature that all displayed conductivity measurements will be reported to using the selected temperature compensation
Temp. Compensation	Linear , nLFn, nLFu, EP, Off	Set the temperature compensation type used to calculate and report conductivity measurements at the selected reference temperature
Temperature Coeff.	2.10	Enter the temperature coefficient value for linear temperature compensation
Stability	Smart , Fast, Medium, Slow	Set when a measurement is recognized as stable
Averaging	Off, Automatic Smart	Set averaging for faster measurement stability
Alarm	Limit Alarm Off , On	Set high and low limit values to activate alarm
	Cal Due Alarm Off , On	Set a calibration interval (hours) to activate alarm
	Set Point Alarm Off , On	Set a base and offset value to activate alarm
Cell Type	Standard , USP	Select Standard for most conductivity probes or USP for ultra-pure water 2-cell conductivity probe (Catalog Number 013016MD)
Electrode SI No	----	Use the alphanumeric keypad to enter the serial number or clear all to shown no value (----)
Sample ID	Off , Manual, Auto Increment	Use the popup keypad screen to enter an alphanumeric manual ID or a numeric value as the starting value for auto incremental ID

Detailed information on these features is available in the [Appendix](#) section of this user manual.

TDS Mode Menu



Main Menu	Settings	Details
Read Type	Auto-Read , Timed, Single-Shot, Continuous	For Timed and Single-Shot, set the time in hours, minutes, seconds using the arrow keys
Cell K	0.475	Enter the nominal cell constant (K) value of the conductivity probe; value is used when performing an automatic conductivity calibration
TDS Factor	Linear , ISO/EN 27888 0.49	Set the TDS factor type used to convert conductivity to TDS measurements; enter a 0.02 to 9.99 value for the Linear TDS factor type
Ref. Temperature	5°C, 10°C, 15°C, 20°C, 25°C	Set the reference temperature that all displayed TDS measurements will be reported to using the selected temperature compensation
Temp. Compensation	Linear , nLFn, nLFu, EP, Off	Set the temperature compensation type used to calculate and report TDS measurements at the selected reference temperature
Temperature Coeff.	2.10	Enter the temperature coefficient value for linear temperature compensation
Stability	Smart , Fast, Medium, Slow	Set when a measurement is recognized as stable
Averaging	Off, Automatic Smart	Set averaging for faster measurement stability
Alarm	Limit Alarm Off , On	Set high and low limit values to activate alarm
	Set Point Alarm Off , On	Set a base and offset value to activate alarm
Cell Type	Standard , USP	Select Standard for most conductivity probes or USP for ultra-pure water 2-cell conductivity probe

Detailed information on these features is available in the [Appendix](#) section of this user manual.

Salinity Mode Menu

Main Menu	Settings	Details
Read Type	Auto-Read , Timed, Single-Shot, Continuous	For Timed and Single-Shot, set the time in hours, minutes, seconds using the arrow keys
Cell K	0.475	Enter the nominal cell constant (K) value of the conductivity probe; value is used when performing an automatic conductivity calibration
Salinity Type	Practical Salinity , Sea Water	Set the salinity type used to convert conductivity to salinity measurements
Stability	Smart , Fast, Medium, Slow	Set when a measurement is recognized as stable
Averaging	Off, Automatic Smart	Set averaging for faster measurement stability
Alarm	Limit Alarm Off , On	Set high and low limit values to activate alarm
	Set Point Alarm Off , On	Set a base and offset value to activate alarm
Cell Type	Standard , USP	Select Standard for most conductivity probes or USP for ultra-pure water 2-cell conductivity probe

Detailed information on these features is available in the [Appendix](#) section of this user manual.

Resistivity Mode Menu

Main Menu	Settings	Details
Read Type	Auto-Read , Timed, Single-Shot, Continuous	For Timed and Single-Shot, set the time in hours, minutes, seconds using the arrow keys
Cell K	0.475	Enter the nominal cell constant (K) value of the conductivity probe; value is used when performing an automatic conductivity calibration
Ref. Temperature	5°C, 10°C, 15°C, 20°C, 25°C	Set the reference temperature that all displayed resistivity measurements will be reported to using the selected temperature compensation
Temp. Compensation	Linear , nLFn, nLFu, EP, Off	Set the temperature compensation type used to calculate and report resistivity measurements at the selected reference temperature
Temperature Coeff.	2.10	Enter the temperature coefficient value for linear temperature compensation
Stability	Smart , Fast, Medium, Slow	Set when a measurement is recognized as stable
Averaging	Off, Automatic Smart	Set averaging for faster measurement stability
Alarm	Limit Alarm Off , On	Set high and low limit values to activate alarm
	Set Point Alarm Off , On	Set a base and offset value to activate alarm
Cell Type	Standard , USP	Select Standard for most conductivity probes or USP for ultra-pure water 2-cell conductivity probe

Detailed information on these features is available in the [Appendix](#) section of this user manual.

Conductivity Calibration

One to six conductivity standards can be used for calibration (up to three for an automatic conductivity calibration, up to six for a direct conductivity calibration and one for a manual conductivity calibration). Always use fresh standards and select standards that are near the expected sample conductivity.

Automatic or Direct Conductivity Calibration

Prepare the conductivity probe according to the instructions in the probe user manual. Connect the probe and any other electrodes to be used to the module inputs on the selected channel.

In the measurement mode, press the **channel** key until the channel with the conductivity module with conductivity probe connected is shown. If needed, press the **mode** key until **Cond Measurement** is shown as the measure mode.

For an automatic calibration, use the [Cell Constant Entry](#) procedure or [Conductivity Mode Menu](#) to enter the nominal cell constant of the conductivity probe before the calibration. Use Thermo Scientific™ Orion™ 100 µS/cm, 1413 µS/cm and/or 12.9 mS/cm conductivity standards.

1. Press the **f1 (Cal)** key to start the calibration.
 - a. If more than one channel is displayed in the measurement mode, press the ▲ or ▼ key to highlight the desired channel and press the **f3 (Select)** key.
2. Rinse the conductivity probe and any other electrodes in use with distilled water, blot dry with a lint-free tissue and place into the standard.
3. When the conductivity probe and standard are ready, press the **f3 (Start)** key.
 - a. If using a stirrer probe, the stirrer probe will start stirring when the **f3 (Start)** key is pressed and stop stirring when the reading stabilizes.
4. Wait for the conductivity value on the meter to stabilize and perform one of the following actions:
 - a. Press the **f2 (Accept)** key to accept the displayed value.
or
 - b. Press the **f3 (Edit)** key, press the **f3 (Clear)** key and use the numeric keypad to enter the conductivity value of the standard at the measured temperature. Press the **f2 (Accept)** key to confirm the entered value.
5. Press the **f2 (Next)** key to proceed to the next standard and repeat steps 2 through 4 or press the **f3 (Cal Done)** key to save and end the calibration.
6. The meter will display the calibration summary and export the data to the calibration log. Press the **measure (esc)** key to proceed to the measurement mode.

Conductivity Calibration Editing

Once the **f3 (Cal Done)** key is pressed and the calibration is saved, press the **f2 (Cal Edit)** key to edit the calibration data and fix individual points without a full recalibration. In the calibration edit mode, press the **▲** or **▼** key to highlight a calibration point and press the **f2 (Delete)** key to delete the point or press the **f3 (Re-Measure)** key to re-measure the point. Follow the onscreen text prompts and instructions to edit the selected calibration point.

Orion Conductivity Standard Values from 15 °C to 30 °C

Refer to the [Appendix](#) section of this user manual for additional values from 0 to 50°C.

Temperature (°C)	Orion 111.9mS/cm Standard Cat. No. 011005, 01100510 (mS/cm)	Orion 12.9mS/cm Standard Cat. No. 011006, 01100610 (mS/cm)	Orion 1413µS/cm Standard Cat. No. 011007, 01100710 (µS/cm)	Orion 147µS/cm Standard Cat. No. 01100910 (µS/cm)	Orion 100µS/cm Standard Cat. No. 011008 (µS/cm)
15	92.34	10.46	1145	119	81
16	94.24	10.69	1171	122	83
17	96.15	10.93	1198	125	85
18	98.08	11.16	1224	127	87
19	100.0	11.40	1251	130	88
20	102.0	11.64	1277	133	90
21	103.9	11.88	1304	136	92
22	105.9	12.12	1331	138	94
23	107.9	12.36	1358	141	96
24	109.9	12.61	1386	144	98
25	111.9	12.85	1413	147	100
26	113.9	13.10	1441	150	102
27	115.9	13.35	1468	153	104
28	117.9	13.59	1496	156	106
29	120.0	13.84	1524	159	108
30	122.0	14.09	1552	161	110

Cell Constant Entry (Manual Conductivity Calibration)

1. Press the **f1 (Cal)** key to start the calibration.
 - a. If more than one channel is displayed in the measurement mode, press the ▲ or ▼ key to highlight the desired channel and press the **f3 (Select)** key.
2. Press the **f2 (Cell K)** key and wait for the cell constant value on the meter to stabilize.
3. Press the **f2 (Accept)** key to accept the displayed value or press the **f3 (Edit)** key, press the **f3 (Clear)** key, use the numeric keypad to enter the cell constant value of the conductivity probe and press the **f2 (Accept)** key to confirm the entered value.
4. The meter will save the entered cell constant value as the nominal cell constant of the conductivity probe and return to the main calibration display. Press the **measure (esc)** key to proceed to the measurement mode or perform the [Automatic or Direct Conductivity Calibration](#) procedure.

Conductivity Verification Procedure

Use the Orion Star series conductivity verification kit, Catalog Number 1010001, to verify the accuracy of the conductivity measurements on the Versa Star Pro meter with conductivity module. The conductivity value for each resistor should fall within the relative accuracy of the resistor ($\pm 0.1\%$ of the actual conductance of the resistor) plus the relative accuracy of the meter

($\pm 0.5\%$ of reading ± 1 digit for conductivity readings greater than $3\ \mu\text{S}/\text{cm}$ and $\pm 0.5\%$ of reading $\pm 0.01\ \mu\text{S}/\text{cm}$ for conductivity readings less than or equal to $3\ \mu\text{S}/\text{cm}$).

1. Ensure that the conductivity resistor kit is certified and calibration date valid.
2. Press the **f1 (Cal)** key to start the calibration.
 - a. If more than one channel is displayed in the measurement mode, press the **▲** or **▼** key to highlight the desired channel and press the **f3 (Select)** key.
3. Press the **f2 (Cell K)** key, wait for the cell constant value on the meter to stabilize and press the **f3 (Clear)** key. Use the numeric keypad to enter the cell constant value as "1.000" and press the **f2 (Accept)** key to confirm the entered value.
4. Press the **measure (esc)** key to proceed to the measurement mode.
5. Connect a resistor to the meter, press the **measure (esc)** key, wait for the measurement value to stabilize and record the conductivity value of the resistor. Repeat the procedure for all six resistors in the kit.

Resistor Number	Nominal Resistance	Nominal Conductance	Nominal Acceptance Range
1010001-A	1000 K Ω	1 μS	0.984 to 1.016 μS
1010001-B	100 K Ω	10 μS	9.930 to 10.07 μS
1010001-C	10 K Ω	100 μS	99.30 to 100.7 μS
1010001-D	1 K Ω	1000 μS	993.0 to 1007 μS
1010001-E	100 Ω	10 mS	9.930 to 10.07 mS
1010001-F	10 Ω	100 mS	99.30 to 100.7 mS

Note: These are the nominal values for the resistors only. The actual resistance and conductance is printed on each resistor and the actual acceptance range must be calculated from the actual value on each resistor.

6

Chapter 6 **RDO/DO Measurement Module**

Connecting Electrodes to the Module

To begin using the Versa Star Pro meter and module system, prepare the meter and insert the module into an available channel on the back of the meter. See [Chapter 2 Meter Basics](#) for instructions. For information on customizing meter settings, refer to [Chapter 3 Setup Menu](#).

- It is recommended that electrodes be placed in the meter-attached electrode stand for easy movement in and out of beakers during calibration, sample measurement and storage.

VSTAR-RD Versa Star RDO/Dissolved Oxygen Module

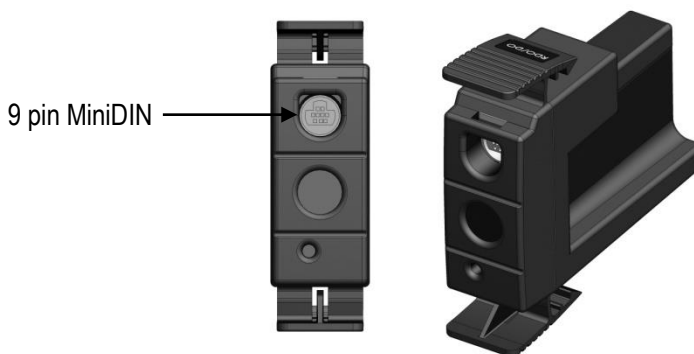

1. Connect the dissolved oxygen (DO) probe to the 9 pin MiniDIN connector on the module. The temperature will also be measured when the DO probe is connected.
 - An Orion RDO optical DO probe or Orion polarographic DO probe can be connected and the meter will automatically detect the probe type.
2. Prepare the DO probe for use as instructed in the probe user manual.

Channel 1-4 Setup Menus

Mode Menu for Dissolved Oxygen

Within the Channel 1, Channel 2, Channel 3 and Channel 4 setup menus are Method, Mode and Temperature submenus, which can be used to customize measurement settings and parameters for the selected channel. This section provides detailed information on the Mode menus for each measurement parameter available when using a RDO/DO module.

3. In the measurement mode, press the **setup** key.
4. Press the ▲, ▼, ◀ or ▶ key to highlight Channel 1, Channel 2, Channel 3 or Channel 4 and press the **f3 (Select)** key.
 - a. Select the appropriate channel number that the module of interest is connected.
5. Press the ◀ or ▶ key to highlight Mode and press the **f3 (Select)** key.

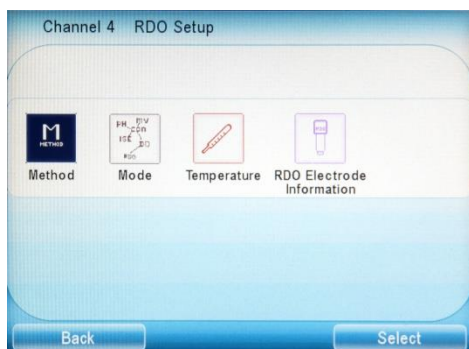

6. Press the ▲ or ▼ key to highlight a menu option and press the ◀ or ▶ key to highlight a submenu option. Onscreen text prompts provide instructions for changing parameters within a selected menu option.
 - a. Use the popup alphanumeric keypad screen for menu options including Electrode Serial Number and Sample ID.
 - i. Press the ▲, ▼, ◀ or ▶ key to highlight a character, press the **f2 (Enter)** key to input the character and repeat until the desired name is entered.
 - ii. Press the **f3 (Clear)** key to delete any undesired characters.

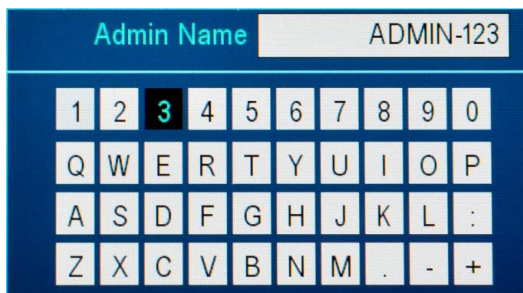

- iii. Press the **f1 (Done)** key to save the entry.

RDO and DO Mode Menu



Main Menu	Settings	Details
Electrode SI No	----	Use the alphanumeric keypad to enter the serial number or clear all to shown no value (----)
Sample ID	Off , Manual, Auto Increment	Use the popup keypad screen to enter an alphanumeric manual ID or a numeric value as the starting value for auto incremental ID
Measurement Unit	mg/L, %	Set the displayed measurement units
Resolution	0.1, 0.01 1, 0.1	Set the resolution of the measurement value
Stability	Smart , Fast, Medium, Slow	Set when a measurement is recognized as stable
Averaging	Off, Automatic Smart	Set averaging for faster measurement stability
Read Type	Auto-Read , Timed, Single-Shot, Continuous	For Timed and Single-Shot, set the time in hours, minutes, seconds using the arrow keys
Pressure Comp	Auto , Manual 775.0	Set the barometric pressure compensation source as Auto to use the built-in barometer or Manual to enter a value. Select the Auto option to calibrate the barometer pressure reading
Salinity Correction	Auto , Manual	Set the salinity correction source as Auto to use a conductivity module and probe to measure the sample salinity or Manual to enter a value
Alarm	Limit Alarm Off , On	Set high and low limit values to activate alarm
	Cal Due Alarm Off , On	Set a calibration interval (hours) to activate alarm
	Set Point Alarm Off , On	Set a base and offset value to activate alarm

Detailed information on these features is available in the [Appendix](#) section of this user manual.

RDO Electrode Information

The serial number, remaining cap life and date of manufacture for each RDO optical cap can be viewed in the RDO Electrode Information menu when the RDO probe is connected to the meter and recognized in the measurement mode.

Verify that the RDO probe is connected to the meter. In the measurement mode, press the **setup** key. Press the ◀ or ▶ key to highlight Channel # (channel with the RDO probe) and press the **f3 (Select)** key. Press the ◀ or ▶ key to highlight RDO Electrode Information and press the **f3 (Select)** key.

Dissolved Oxygen Calibration

Note: A polarographic DO probe must be polarized prior to use. The probe is continuously polarized when connected to the meter. If the polarographic DO probe is new, has been serviced or has not been connected to the meter: connect the probe to the meter, power on the meter and wait 30 minutes for the probe to polarize.

The Versa Star Pro meter with RDO/DO module offers the following calibration options:

- **Water Saturated Air** – This is the simplest and most accurate method and uses the calibration sleeve included with most DO probes. For best accuracy, the calibration temperature should match the expected sample temperature. Moisten the sponge in the calibration sleeve with distilled water and insert the probe into the sleeve. A BOD bottle can be used with just enough distilled water to cover the bottom without touching the probe.
- **Air Saturated Water** – This method uses water that is 100% saturated with air. Bubble air into a water sample for an extended period, preferably overnight.
- **Manual (Winkler)** – This method uses a water sample with a known concentration of dissolved oxygen and is typically used to calibrate the DO probe to the value achieved by a Winkler titration. Due to possible titration errors, this method is inherently less accurate.
- **Set Zero** – This method uses an oxygen free solution to add a zero point to an existing Water Saturated Air or Air Saturated Water calibration. This calibration is generally recommended when measurements are below 10% saturation or 1 mg/L.

Prepare the DO probe according to the instructions in the probe user manual. Connect the probe and any other electrodes to be used to the module inputs on the selected channel.

In the measurement mode, press the **channel** key until the channel with the RDO/DO module with DO probe connected is shown.

Water Saturated Air Calibration

1. Press the **f1 (Cal)** key to start the calibration.
 - a. If more than one channel is displayed in the measurement mode, press the **▲** or **▼** key to highlight the desired channel and press the **f3 (Select)** key.
2. Press the **▲** or **▼** key to highlight Water Saturated Air and press the **f3 (Select)** key.
3. Prepare the DO probe and calibration sleeve and allow them to reach equilibrium.
4. When the DO probe and calibration sleeve are ready, press the **f3 (Start)** key.
5. Wait for the dissolved oxygen value on the meter to stabilize and press the **f2 (Accept)** key.
 - a. With a polarographic DO probe, 102.3 % will be displayed when the reading stabilizes.
 - b. With an RDO optical DO probe, 100.0 % will be displayed when the reading stabilizes.

6. Press the **f3 (Cal Done)** key to save and end the calibration.
7. The meter will display the calibration summary and export the data to the calibration log. Press the **measure (esc)** key to proceed to the measurement mode.

Air Saturated Water Calibration

1. Press the **f1 (Cal)** key to start the calibration.
 - a. If more than one channel is displayed in the measurement mode, press the ▲ or ▼ key to highlight the desired channel and press the **f3 (Select)** key.
2. Press the ▲ or ▼ key to highlight Air Saturated Water and press the **f3 (Select)** key.
3. Prepare the DO probe and 100% air-saturated water and allow them to reach equilibrium.
 - a. Use plastic paraffin film to seal the open area between the DO probe and vessel containing the 100% air-saturated water.
4. When the DO probe and calibration apparatus are ready, press the **f3 (Start)** key.
 - a. If using a stirrer probe, the stirrer probe will start stirring when the **f3 (Start)** key is pressed and stop stirring when the reading stabilizes.
5. Wait for the dissolved oxygen value on the meter to stabilize and press the **f2 (Accept)** key.
 - a. 100.0 % will be displayed when the reading stabilizes.
6. Press the **f3 (Cal Done)** key to save and end the calibration.
7. The meter will display the calibration summary and export the data to the calibration log. Press the **measure (esc)** key to proceed to the measurement mode.

Manual (Winkler) Calibration

1. Press the **f1 (Cal)** key to start the calibration.
 - a. If more than one channel is displayed in the measurement mode, press the ▲ or ▼ key to highlight the desired channel and press the **f3 (Select)** key.
2. Press the ▲ or ▼ key to highlight Manual and press the **f3 (Select)** key.
3. Prepare the DO probe and calibration solution and allow them to reach equilibrium.
 - a. Use plastic paraffin film to seal the open area between the DO probe and vessel containing the calibration solution.
4. When the DO probe and calibration apparatus are ready, press the **f3 (Start)** key.
 - a. If using a stirrer probe, the stirrer probe will start stirring when the **f3 (Start)** key is pressed and stop stirring when the reading stabilizes.

5. Wait for the dissolved oxygen value on the meter to stabilize and perform one of the following actions:
 - a. Press the **f2 (Accept)** key to accept the displayed value.
 - or
 - b. Press the **f3 (Edit)** key and use the numeric keypad to enter the dissolved oxygen value of the calibration solution. Press the **f2 (Accept)** key to confirm the entered value.
6. Press the **f3 (Cal Done)** key to save and end the calibration.
7. The meter will display the calibration summary and export the data to the calibration log. Press the **measure (esc)** key to proceed to the measurement mode.

Set Zero Calibration

A Water Saturated Air calibration or Air Saturated Water calibration must be completed before a Set Zero calibration can be performed.

Prepare a sodium sulfite solution by dissolving about 15.0 grams of Na_2SO_3 in about 250 mL of distilled water. Transfer the solution to a BOD bottle or flask and use plastic paraffin film to seal the bottle. A small amount of cobalt salt can be added to the sodium sulfite solution to act as an indicator and change color when the sodium sulfite solution no longer has zero oxygen content.

1. Press the **f1 (Cal)** key to start the calibration.
 - a. If more than one channel is displayed in the measurement mode, press the **▲** or **▼** key to highlight the desired channel and press the **f3 (Select)** key.
2. Press the **▲** or **▼** key to highlight Set Zero and press the **f3 (Select)** key.
3. Prepare the DO probe and zero oxygen solution and allow them to reach equilibrium.
 - a. Use plastic paraffin film to seal the open area between the DO probe and vessel containing the calibration solution.
4. When the DO probe and calibration apparatus are ready, press the **f3 (Start)** key.
 - a. If using a stirrer probe, the stirrer probe will start stirring when the **f3 (Start)** key is pressed and stop stirring when the reading stabilizes.
5. Wait for the dissolved oxygen value on the meter to stabilize and press the **f2 (Accept)** key.
 - a. 0.0 % will be displayed when the reading stabilizes.
6. Press the **f3 (Cal Done)** key to save and end the calibration.
7. The meter will display the calibration summary and export the data to the calibration log. Press the **measure (esc)** key to proceed to the measurement mode.

7

Chapter 7 Meter Measurements

Measurement Overview

The type of module connected to each of the four channels on the Versa Star Pro meter will define the measurement capability of that channel.

Versa Star Module	Measurement Capabilities
pH module	pH, mV, relative mV or ORP with temperature
pH/ISE module	pH, mV, relative mV, ORP or concentration (ISE) with temperature
pH/LogR module	pH, mV or ORP with temperature/LogR temperature
Conductivity module	Conductivity, TDS, salinity or resistivity with temperature
RDO/DO module	Dissolved oxygen as % saturation or concentration with temperature

When two or more modules are connected to the meter, pressing the **channel** key will change the number and combination of channels displayed in the measurement mode. Each channel can be displayed individually or two to four channels can be displayed simultaneously.

The information shown in the measurement mode can be customized using the [Instrument Settings](#) setup menu. The channel number, measure mode, method, stability indicator, temperature, secondary measurement parameter, calibration details, user ID, sample ID and electrode serial number can each be shown or hidden. Hiding these items in the measurement display will increase the font size of the main measurement value in the single channel display.

- Use the Buzzer – Ready setting in the [Instrument Settings](#) setup menu to enable an audible beep when a measurement becomes stable.

Example Measurement Mode and Channel Displays

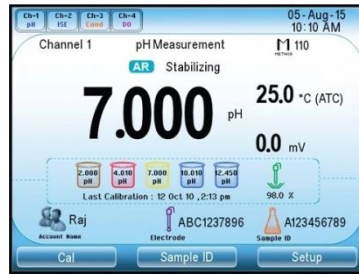

pH Mode Display

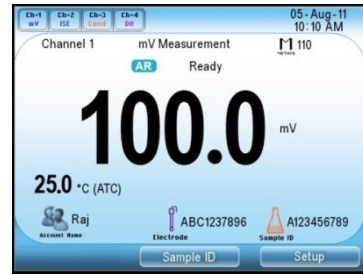

mV Mode Display

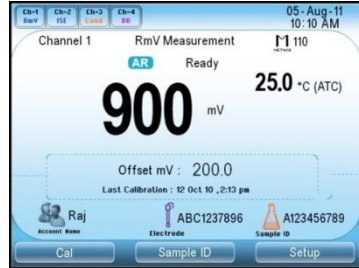

RmV Mode Display



ORP Mode Display

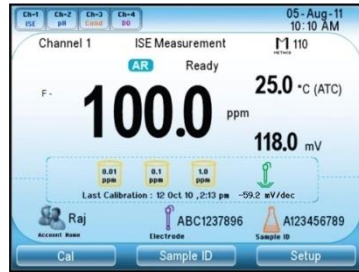

ISE Mode Display



pH/LogR Mode Display

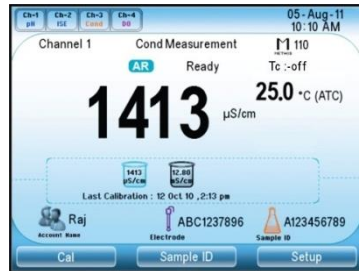

Conductivity Mode Display

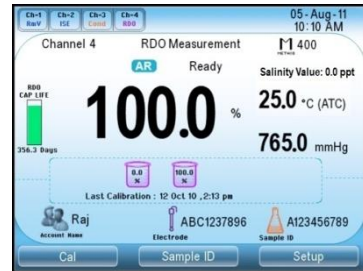

Dissolved Oxygen Mode Display

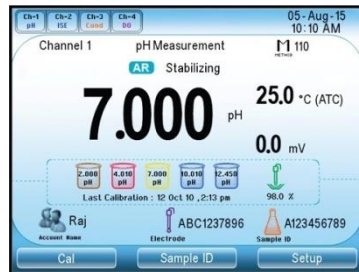

One Channel Display

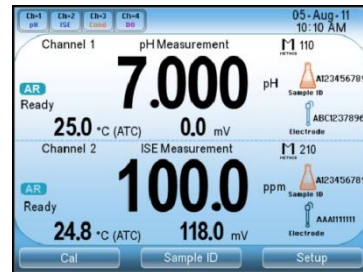

Two Channel Display

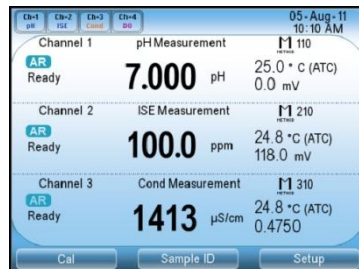

Three Channel Display



Four Channel Display

Measurement Read Types

Versa Star Pro meters have four options for the measurement read type – Auto-Read, Timed, Single-Shot and Continuous. The read type determines how the meter takes a measurement and when the measurement is sent to the data log and external device. The read type is set individually for each channel and measure mode using the Mode setup menu described in each module chapter – [Mode Menus for pH, mV, Relative mV, ORP and ISE](#), [Mode Menus for Conductivity, TDS, Salinity and Resistivity](#) and [Mode Menus for Dissolved Oxygen](#).

1. In the measurement mode, press the **setup** key.
2. Press the ◀ or ▶ key to highlight a channel setup menu and press the **f3 (Select)** key.
3. Press the ◀ or ▶ key to highlight Mode and press the **f3 (Select)** key.
4. Press the ▲ or ▼ key to highlight the appropriate measure mode and press the **f3 (Select)** key. (Step not applicable for channels using the RDO/DO module)
5. Press the ▲ or ▼ key to highlight Read Type and press the ◀ or ▶ key to highlight Auto-Read, Timed, Single-Shot or Continuous as the read type.
 - a. For Timed and Single-Shot, enter the time value using the ◀ or ▶ key to scroll to the hours (HH), minutes (MM) or seconds (SS) field and the ▲ or ▼ key to increase or decrease the value. Press the **f1 (Done)** key to confirm the value.
6. Press the **measure (esc)** key to return to the measurement mode.

Auto-Read

When Auto-Read is selected as the read type, a measurement is initiated by pressing the **measure (esc)** key in the measurement mode. The changing measurement value is shown as it stabilizes and the **AR** icon will blink. Once the value is stable, the measurement is locked and held on the display and the **AR** icon will remain solid. To start a new measurement, press the **measure (esc)** key.

Depending on the meter communication settings in the [Instrument Settings](#) setup menu, the locked measurement value will be exported to the data log, printer and/or computer.

Timed

When Timed is selected as the read type and a time interval is entered, measurements are recorded at the predefined time intervals. The meter will continue to record measurements at the predefined time intervals until the measurement mode is exited. Measurements are continuously updated on the display and the **Stabilizing** and **Ready** icons specify the measurement value stability.

Depending on the meter communication settings in the [Instrument Settings](#) setup menu, the recorded measurement values will be exported to the data log, printer and/or computer.

Single-Shot

When Single-Shot is selected as the read type and a wait time is entered, a single measurement is recorded, locked and held on the display after the predefined wait time has elapsed. To start a new measurement using the same wait time, press the **measure (esc)** key.

Depending on the meter communication settings in the [Instrument Settings](#) setup menu, the recorded measurement value will be exported to the data log, printer and/or computer.

Continuous

When Continuous is selected as the read type, measurements are continuously updated on the display and the **Stabilizing** and **Ready** icons specify the measurement value stability. This is useful when performing an experiment that requires continuous measurements to be observed.

Depending on the meter communication settings in the [Instrument Settings](#) setup menu, press the **log/print** key to export a measurement to the data log, printer and/or computer.

Read Type Priority

When two or more modules are connected to the meter and displayed in the measurement mode, the Versa Star Pro meter will use a priority structure to determine when the displayed measurements are sent to the data log and external devices, if they are enabled in the [Instrument Settings](#) setup menu.

Priority	Primary Read Type	Additional Read Types	Displayed Measurements	Export to Data Log and/or Device
1	Timed	Timed	Continuously updated	All displayed measurements are exported at shortest time interval setting
		Auto-Read	Locked when stable, press the measure (esc) key to update	
		Single-Shot	Locked when wait time elapses, press the measure (esc) key to update	
		Continuous	Continuously updated	
2	Auto-Read	Auto-Read	Locked when stable, press the measure (esc) key to update	All displayed measurements are exported when all Auto-Read channels are stable
		Single-Shot	Locked when wait time elapses or all Auto-Read channels are stable, whichever occurs first	
		Continuous	Continuously updated	
3	Single-Shot	Single-Shot	Locked when wait time elapses, press the measure (esc) key to update	All displayed measurements are exported when wait time elapses for all Single-Shot channels
		Continuous	Continuously updated	
4	Continuous	Continuous	Continuously updated	Press the log/print key to exported all displayed measurements

Measurement Procedure

As needed, customize the information shown in the measurement mode using the [Instrument Settings](#) setup menu. If two or more modules are connected to the meter, while in the measurement mode press the **channel** key until the desired combination of meter channels are shown. Select the read type for all meter channels shown in the measurement mode.

Prepare the electrodes according to the instructions in the electrode user manuals. Connect the electrodes to the module inputs on the displayed channels. Make sure the electrodes are properly calibrated and working correctly.

1. Rinse the electrodes with distilled water or appropriate solution, blot dry with a lint-free tissue and place into the sample.
2. Start the measurement and wait for the reading to stabilize or reach the predefined time.
 - a. Auto-Read: Press the **measure (esc)** key to start the measurement. If using a stirrer probe, the stirrer probe will start stirring when the **measure (esc)** key is pressed and stop stirring when the measurement stabilizes.
 - b. Timed: Measurements will start immediately when in the measurement mode. If using a stirrer probe, press the **stirrer** key to start and stop stirring.
 - c. Single-Shot: Press the **measure (esc)** key to start the measurement. If using a stirrer probe, the stirrer probe will start stirring when the **measure (esc)** key is pressed and stop stirring when the predefined wait time has elapsed.
 - d. Continuous: Measurements will start immediately when in the measurement mode. If using a stirrer probe, press the **stirrer** key to start and stop stirring.
3. Once the measurement is stable or reaches the set time, record all applicable parameters.
 - a. Auto-Read: Once the measurement is stable, it will be locked and held on the display and the **AR** icon will remain solid. If the data log function is enabled, the measurement will be exported to the data log.
 - b. Timed: Measurements will be recorded at the predefined time interval. If the data log function is enabled, the  icon will be shown when each time interval has elapsed and the measurement is exported to the data log.
 - c. Single-Shot: Once the predefined wait time has elapsed, the measurement will be locked and held on the display. If the data log function is enabled, the measurement will be exported to the data log.
 - d. Continuous: The flashing **Stabilizing** icon will update to the solid **Ready** icon when the measurement is stable. If the data log function is enabled, press the **log/print** key to export the measurement to the data log.
4. Remove the electrodes from the sample, rinse with distilled water or appropriate solution, blot dry with a lint-free tissue and place into the next sample.
5. Repeat steps 2 through 4 for all samples. When all samples have been measured, store the electrodes according to the instructions in the electrode user manuals.

Measurement Tip – Using the Electrode Holder

It is recommended that electrodes be placed in the meter-attached electrode stand for easy movement in and out of beakers during calibration, sample measurement and storage.

The included electrode stand can be attached to either side of the meter. The recommended electrode positions for the electrode holder portion of the stand are shown below.

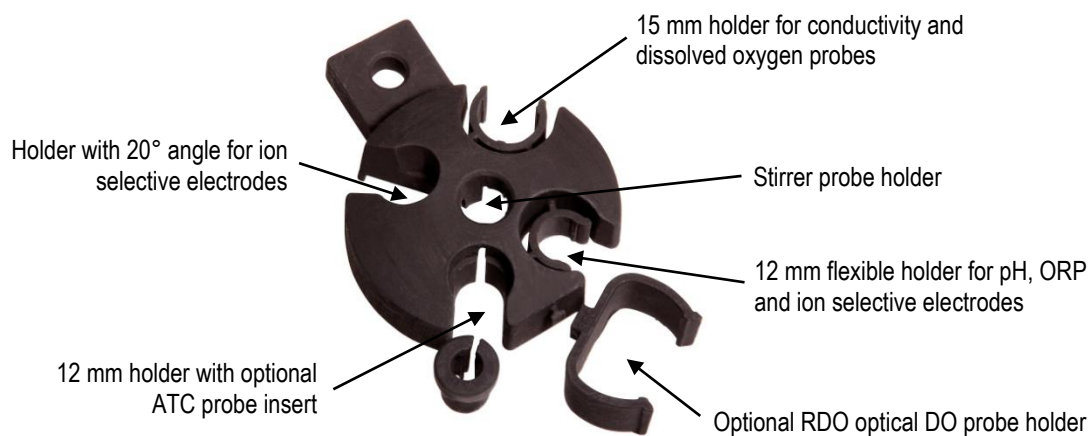

8

Chapter 8 **Data Transfer and Software Updates**

Data Transfer Settings

Review the following sections of this user manual for detailed information on the data storage and transfer settings available with Versa Star Pro meters.

User Manual Section	Topic for Review
Meter Connections	Meter inputs used to connect a computer or printer
Instrument Settings	Meter communication, data log and printing settings
Log View	Viewing and exporting the data log and calibration log from the meter to an external device
Measurement Read Types	How the meter takes a measurement and when the measurement is sent to the data log and external device

If measurements will be saved to the data log and then transferred to a computer or printer, make sure the data log is enabled in the setup menu, the meter communication settings match the computer or printer settings and the meter and computer or printer are properly interfaced.

Thermo Scientific™ Orion™ Navigator Pro™ computer software (Cat. No. VSTAR-NPUSB) is an available accessory for Orion Versa Star Pro meters and is designed to offer a computer-driven measurement system for generating electronic measurements, calibration data and audit trails. Orion Navigator Pro software offers multi-level system access for an administrator and 10 users. The admin can customize each user's access level from full system access to basic data collection only. The Navigator Pro software controls all meter settings, data collection and reporting to help ensure data integrity and complete audit trail.

Data Transfer Examples

5 Point pH Calibration, Printer Format

```

-----
Thermo Scientific (c) 2011

ORION Versa Star

Meter S/N          V00000
SW Rev            2.73

Channel           1
Probe S/n         SENSOR-01
Module S/n        VA00000
Method            101
Calibration Time  02-Aug-12,3:40 PM
User ID           USER-01

-- pH Calibration Report --
Point             1
pH                2.000
mV                290.5
Temperature       25.0 C (MAN)
Calibration Type  Auto & Manual

Point             2
pH                4.010
mV                174.3
Temperature       25.0 C (MAN)
Calibration Type  Auto & Manual

Point             3
pH                6.997
mV                0.0
Temperature       25.0 C (MAN)
Calibration Type  Auto & Manual

Point             4
pH                10.013
mV                -173.7
Temperature       25.0 C (MAN)
Calibration Type  Auto & Manual

Point             5
pH                12.000
mV                -289.5
Temperature       25.0 C (MAN)
Calibration Type  Auto & Manual

Slope 1           97.7 %
Slope 2           98.6 %
Slope 3           97.4 %
Slope 4           98.6 %
Eo 1              1.4 mV
Eo 2              -0.2 mV
Eo 3              -0.2 mV
Eo 4              2.0 mV
Average Slope     98.1 %
Cal #             101

Operator          _____

```

5 Point pH Calibration, CSV Format

HyperTerminal View:

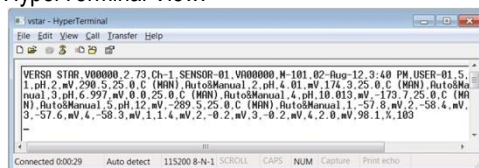

Text:

```

VERSA STAR,V00000,2.73,Ch-1,
SENSOR-01,VA00000,M-101,02-Aug-12,3:40 PM,
USER-01,5,1,pH,2,mV,290.5,25.0,C (MAN),
Auto&Manual,2,pH,4.01,mV,174.3,25.0,C (MAN),
Auto&Manual,3,pH,6.997,mV,0.0,25.0,C (MAN),
Auto&Manual,4,pH,10.013,mV,-173.7,25.0,
C(MAN),Auto&Manual,5,pH,12,mV,-289.5,25.0,C
(MAN),Auto&Manual,1,-57.8,mV,2,-58.4,mV,3,
-57.6,mV,4,-58.3,mV,1,1.4,mV,2,-0.2,mV,3,-0.2,
mV,4,2.0,mV,98.1,%,103

```

pH Measurement, Printer Format

```

-----
Thermo Scientific (c) 2011

ORION Versa Star

Meter S/N          V00000
SW Rev            2.73

02-Aug-12,6:06:12 PM

Channel - 1

Probe S/n          SENSOR-01
Sample ID          9
User ID            USER-01
Module S/n #       VA00000
Mode               pH
pH                 6.997 pH
mV                 0.0 mV
Temperature        25.0 C (MAN)
Average Slope      98.1 %
Method             101
CalLog #           PH CAL 103
Last Cal           02-Aug-12,3:40 PM

Operator          _____

```

pH Measurement, CSV Format

HyperTerminal View:

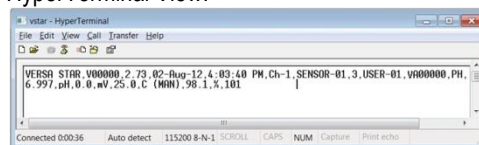

Text:

```

VERSA STAR,V00000,2.73,02-Aug-12, 4:03:40
PM,Ch-1,SENSOR-01,3,USER-01,
VA00000,PH,6.997,pH,0.0,mV,25.0,C
(MAN),98.1,%,101

```

Installing the Versa Star USB Driver Software

Note: Installation of the USB driver is required to transfer data from the Versa Star Pro meter to a computer via the USB port. The driver is not required to update the meter software.

1. Download the Versa Star Pro meter USB driver file on our website and unzip the file to the computer's desktop. The file can also be downloaded from the Versa Star Pro Literature CD that is included with meter and saved to the computer desktop.
2. Connect the power adapter to the meter and power on the meter.
3. Connect the USB cable to Mini B USB input on the meter and USB input on a computer.
4. The Found New Hardware Wizard window will open. Select "No, not this time" and click the Next button.
 - a. If the meter does not give a popup message, go to the Device Manager, expand the Ports or Other Devices option and double-click the IAR file.
5. Select "Install from a list or specific location (Advanced)" and click the Next button.
6. Select "Search for the best driver in these locations" and check the box next to the "Include this location in the search:" option. Click the Browse button and set the computer desktop as the location. Click the Next button.
7. Wait while the driver is loaded and accept any warning messages. Once the installation is complete, click the Finish button
8. Set the Versa Star Pro meter setup parameters to allow transferring data from the meter to the computer via the USB drive.
 - a. On the meter in the measurement mode, press the **setup** key.
 - b. Press the ◀ or ▶ key to highlight Instrument Settings and press the **f3 (Select)** key.
 - c. Press the ▲ or ▼ key highlight Communication and press the ◀ or ▶ key to highlight USB.
 - d. Press the **f2 (Page 2)** key.
 - e. Press the ▲ or ▼ key to highlight Printing and press the ◀ or ▶ key to highlight On.
 - f. Press the ▲ or ▼ key to highlight Print Format and press the ◀ or ▶ key to highlight CSV (comma delimited text) or Printer (standard text).
 - g. Press the **measure (esc)** key to return to the measurement mode.
9. Review the computer COM port location and settings in the Device Manager.
 - a. Expand the Ports option and double click the "IAR Virtual COM port" option.
 - b. The Property window for the IAR Virtual COM port will open. Select the Port Settings tab and make sure the communication settings are: Bits per second: 115200; Data bits: 8; Parity: None; Stop bits: 1; Flow control: None
10. The meter is now able to transfer data to the computer using the virtual COM port and HyperTerminal or similar program.

Meter Software Upgrade Procedure

Note: Back up all stored data in the meter before updating the meter software.

1. Download the latest software file for your Orion Versa Star Pro meter. The file will be in a compressed ZIP format.
2. Unzip or extract the file to the computer's desktop. Note that the file must be extracted before it can be used.
3. Disconnect the power adapter from the meter.
4. Connect the USB cable (included with meter) to the MINI B USB input on the back of the meter and USB input on the computer.

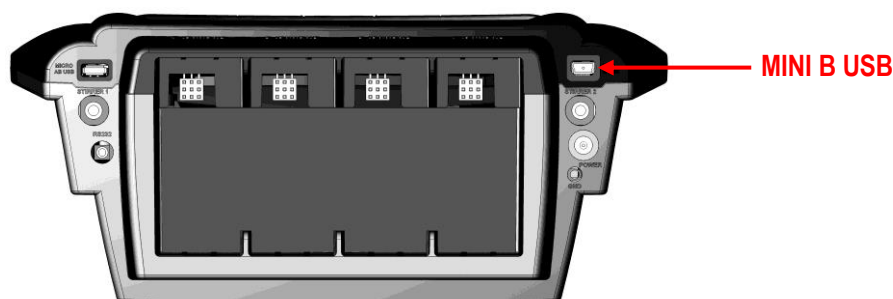

5. Press and hold down the **f1** key on the meter keypad and then connect the power adapter to the meter.
 - a. Note that the meter display will not turn on.
6. After about five seconds, a new NGM_TITAN folder will appear on the computer (for example, an E: drive folder).

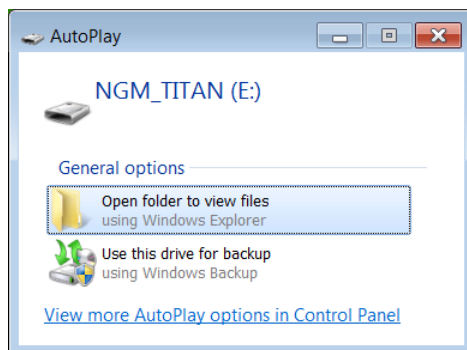

7. Open the folder and then release the **f1** key on the meter keypad.
 - a. If a folder does not appear on the computer, go to the computer's Start menu, select Computer or My Computer, look for an option similar to the example above and open the folder.

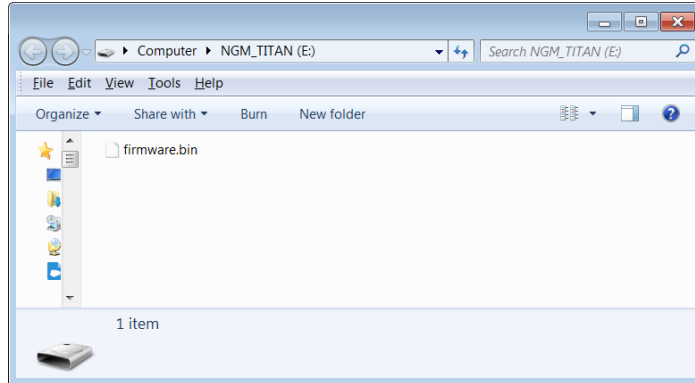

8. Delete the firmware.bin file from the NGM_TITAN folder.

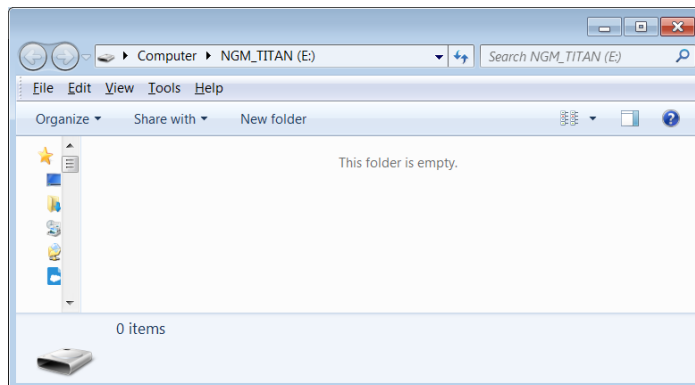

9. Copy and paste the new file from the computer's desktop to the NGM_TITAN folder and wait for the file to transfer completely (about one minute).

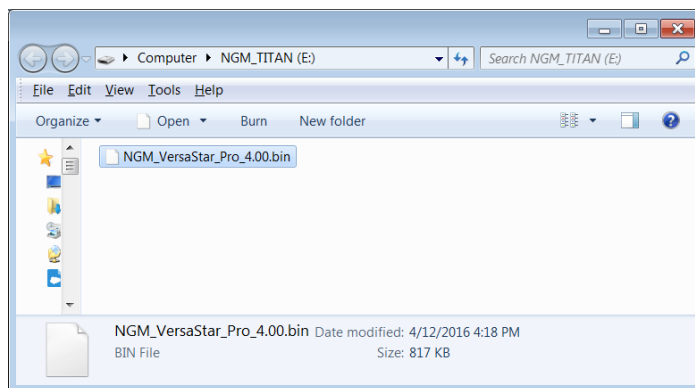

10. Disconnect the power adapter and USB cable from the meter.
11. Reconnect the power adapter to the meter and ensure uninterrupted power to the meter throughout the update process.
12. Wait for the meter to load the software update. As needed, the software of the modules connected with the meter will be automatically updated immediately after the meter software is complete.

Computer and Printer Compatibility

Computer Requirements

The Versa Star USB driver and software update program have been tested with Microsoft® Windows® XP, Windows Vista® and Windows 7 operating systems. We are always working to update our programs, so please contact our technical support team for the latest Windows compatibility updates.

The computer must be up-to-date with the latest Windows updates installed and have .NET framework version 4.0 with the latest updates.

It is strongly recommended that all computer screen savers and power management settings be disabled when the meter is interfaced with the computer. The computer must not go into sleep/standby mode while the software update is performed. Many laptop computers go into sleep/standby mode when the lid is closed, so the lid should remain open throughout the software update. Laptop computers must also be plugged into a power supply when running the software update – performing the software update while the computer is on battery power is not recommended.

Printer Requirements

Versa Star Pro meters can print directly to the Orion Star A series compact ink ribbon printer (Catalog Number STARA-106) or certain models of USB dedicated printers with PCL 5 or PCL 6 printer language capability.

Orion Versa Star Pro meters offer expanded USB printer compatibility with new PCL 6 driver hardware for better compatibility with recent, commercially available USB printers. Although we strive to ensure the compatibility of our meters with USB printers, we cannot ensure compatibility with all models.

Tested Printer Models:

- Fuji Xerox DocuPrint P225D
- HP LaserJet Pro MFP M225DW

Printer Component and Requirements

- Meter: Orion Versa Star Pro meter, serial number V10000 or higher
- Printer: PCL6 driver compatible
- Paper: Letter size format
- Cable: Micro AB USB Male (meter) to printer-specific USB connection (per printer model)

For the tested printer models, the printer cable requirement is Micro AB USB Male to Standard USB B Type cable.

Versa Star Pro Meter Remote Control Protocols

Rules for Remote Control Usage

1. CR (Carriage Return, ASCII 13) is used to terminate a command. Whenever this character is received, the internal buffer will be processed.
2. All characters except for NL (New Line, ASCII 10) are significant. The NL character will be ignored. The meter is not case sensitive, though all lower case characters are converted to upper case internally.
3. Only one command can be executed at a time. No new command can be issued until the current command is finished being processed. When the current command is finished, it will issue the ">" prompt to the user, indicating a new command can be entered.
4. Empty commands (i.e. just a CR) will be ignored and a new prompt will be issued.
5. Incorrect commands will fail to execute. If any commands are mistyped, execute the CR (Carriage Return) command and then reenter the command.
6. It is suggested to use the option to "Append line feeds to incoming line ends" within the ASCII setup within HyperTerminal so the data string ends with a new line instead of overwriting the last line of data with new data string.
7. Set the meter communication settings using the [Instrument Settings](#) setup menu.

Communication Settings	Default RS232 Settings	Default USB Settings
Bits per second	9600	115200
Data bits	8	8
Parity	None	None
Stop bits	1	1
Flow control	None	None

Remote Control Engine

The remote control engine receives input from the serial/USB port and processes it as needed. Commands sent to the remote control interface will be in the form of "OPCODE <OPERAND(s)> ^cR". Line feeds will be ignored. New commands cannot be issued until the previous command has been completed and a prompt is given. A prompt is shown as the greater than symbol (">") followed by a space.

Remote Control Commands

1. The first time the meter is interfaced with a computer, start the terminal program and type the following commands:
 - a. Execute the "SYSTEM" command and confirm a response from the meter.
 - b. Execute the "GETUSERINFO" command immediately after receiving a response from the meter after executing the "SYSTEM" command.
2. A connection has now been established and the remote commands from the following table can now be executed. The ">" symbol will be shown when the previous command has been completed and then a new command can be entered and executed.

GETDATALOG	<p>GETDATALOG <CR> Prints all the logged measurement data If no data is available, will return ">" to receive next command</p> <p>GETDATALOG X, Y X = First data log number Y = Last data log number Prints the logged measurement data in a specified range If no data is available, will return ">" to receive next command Example: GETDATALOG 10, 100 <CR></p>
GETCALLOG	<p>GETCALLOG X <CR> Prints all the logged calibration data If no calibration is available, will return ">" to receive next command X = Select calibration data for specific mode as a number:</p> <p>PH = 1 COND = 6 RMV = 3 DO = 10 ORP = 4 RDO = 12 ISE = 5 INCREMENTAL = 21</p> <p>Example: GETCALLOG 1 <CR></p>
SETCHANNEL	<p>SETCHANNEL X <CR> X = Channel number For multiple channels, enter channel numbers without commas Updates the displayed channel(s) on the meter Example: SETCHANNEL 1 <CR></p>
SETMODE	<p>SETMODE X Y <CR> Changes the measurement mode of the entered channel X = Channel number Y = Measurement mode</p> <p>PH = 1 COND = 6 DO, % Saturation = 10 MV = 2 TDS = 7 DO, mg/L = 11 RMV = 3 SALINITY = 8 ORP = 4 RESISTIVITY = 9 ISE = 5</p> <p>Example: SETMODE 1 1 <CR></p>

<p>To Get Timed Measurements:</p>	<ol style="list-style-type: none"> 1. SETCHANNEL X <CR> <ol style="list-style-type: none"> a. X = Channel number b. For multiple channels, enter channel numbers without commas c. Example: SETCHANNEL 1 <CR> 2. SETREADTYPE X, 2, Z <CR> <ol style="list-style-type: none"> a. X = Channel number b. Y = Read Type (2 = Timed) c. Z = Time interval in seconds d. Example: SETREADTYPE 1, 2, 5 <CR> 3. STOP <CR> <ol style="list-style-type: none"> a. Ends the timed measurement command
<p>To Get Auto-Read Measurements:</p>	<ol style="list-style-type: none"> 1. SETCHANNEL X <CR> <ol style="list-style-type: none"> a. X = Channel number b. For multiple channels, enter channel numbers without commas c. Example: SETCHANNEL 1 <CR> 2. SETREADTYPE X, 1 <CR> <ol style="list-style-type: none"> a. X = Channel number b. Y = Read Type (1 = Auto-Read) c. Z = leave blank d. Example: SETREADTYPE 1, 1 <CR> 3. GETMEAS <CR> <ol style="list-style-type: none"> a. Prints the displayed channel measurement once the Auto-Read stability criteria is met b. Example: GETMEAS <CR>
<p>To Get Single Shot Measurements:</p>	<ol style="list-style-type: none"> 1. SETCHANNEL X <CR> <ol style="list-style-type: none"> a. X = Channel number b. For multiple channels, enter channel numbers without commas c. Example: SETCHANNEL 1 <CR> 2. SETREADTYPE X, 3, Z <CR> <ol style="list-style-type: none"> a. X = Channel number b. Y = Read Type (3 = Single Shot) c. Z = Time interval in seconds d. Example: SETREADTYPE 1, 3, 120 <CR> 3. GETMEAS <CR> <ol style="list-style-type: none"> a. Prints the displayed channel measurement once the Single Shot time interval criteria is met b. Example: GETMEAS <CR>

To Get Continuous Measurements:	<ol style="list-style-type: none"> 1. SETCHANNEL X <CR> <ol style="list-style-type: none"> a. X = Channel number b. For multiple channels, enter channel numbers without commas c. Example: SETCHANNEL 1 <CR> 2. SETREADTYPE X, 4 <CR> <ol style="list-style-type: none"> a. X = Channel number b. Y = Read Type (4 = Continuous) c. Z = leave blank d. Example: SETREADTYPE 1, 4 <CR> 3. GETMEAS <CR> <ol style="list-style-type: none"> a. Prints the displayed channel measurement immediately and continuously until the STOP <CR> command is given b. Example: GETMEAS <CR>
SYSTEM	SYSTEM <CR> Prints the Meter Type, Serial Number, Software Version Example: Versa Star Pro, V11702, 11.20
SETRTC	SETRTC YY MM DD HH MM SS <CR> Set the date and time (in 24-hour format) for the meter Example: SETRTC 18 03 29 15 00 00
GETCHCONFIG	GETCHCONFIG <CR> Prints the meter channel configuration with mode details
GETMODE	GETMODE CHANNEL <CR> Print the channel measurement mode Example: GETMODE 1
ESC	ESC <CR> Stops the command being executed
STOP	STOP <CR> Command stops continuous measurement from meter

Meter Measurement Data Example

Mode	Format Example
pH	Meter Type, Meter Serial Number, Meter Software Revision, Date, Time, Channel Number, Electrode ID, Sample ID, User ID, Module Serial Number, Mode, pH Value, pH Unit, mV Value, mV Unit, Temperature Value, Temperature Unit, Slope Value, Slop Unit, Method Number Example: Versa Star Pro, V11702, 11.20, 29-03-18, 3:50:53 PM, Ch-1, SENSOR-01, 1, ADMIN, VA12345, pH, 7.000, pH, 0.0, mV, 25.0, C (MAN), 100.0, %, M101 <CR>

Mode	Format Example
mV	<p>Meter Type, Meter Serial Number, Meter Software Revision, Date, Time, Channel Number, Electrode ID, Sample ID, User ID, Module Serial Number, Mode, mV Value, mV Unit, Temperature Value, Temperature Unit, Method Number</p> <p>Example: Versa Star Pro, V11702, 11.20, 29-03-18, 3:50:53 PM, Ch-1, SENSOR-01, 1, ADMIN, VA12345, MV, 0.0, mV, 25.0, C (MAN), M101 <CR></p>
RmV	<p>Meter Type, Meter Serial Number, Meter Software Revision, Date, Time, Channel Number, Electrode ID, Sample ID, User ID, Module Serial Number, Mode, Relative mV Value, Relative mV Unit, Raw mV Value, Raw mV Unit, Temperature Value, Temperature Unit, Method Number</p> <p>Example: Versa Star Pro, V11702, 11.20, 29-03-18, 3:50:53 PM, Ch-1, SENSOR-01, 1, ADMIN, VA12345, RMV, 0.1, RmV, 0.0, mV, 25.0, C (MAN), M101 <CR></p>
ORP	<p>Meter Type, Meter Serial Number, Meter Software Revision, Date, Time, Channel Number, Electrode ID, Sample ID, User ID, Module Serial Number, Mode, ORP Value, ORP Unit, Raw mV Value, Raw mV Unit, Temperature Value, Temperature Unit, Method Number</p> <p>Example: Versa Star Pro, V11702, 11.20, 29-03-18, 3:50:53 PM, Ch-1, SENSOR-01, 1, ADMIN, VA12345, ORP, 0.0, ORP, 0.0, mV, 25.0, C (MAN), M101 <CR></p>
ISE	<p>Meter Type, Meter Serial Number, Meter Software Revision, Date, Time, Channel Number, Electrode ID, Sample ID, User ID, Module Serial Number, Mode, Electrode Type, ISE Value, ISE Unit, mV Value, mV Unit, Temperature Value, Temperature Unit, Average Slope Value, Average Slope Unit, Method Number</p> <p>Example: Versa Star Pro, V11702, 11.20, 29-03-18, 3:50:53 PM, Ch-2, SENSOR-02, 1, ADMIN, VA12345, ISE, F-, 1.00, ppm, 0.0, mV, 25.0, C (MAN), 59.2, mV/dec, M201 <CR></p>
Conductivity	<p>Meter Type, Meter Serial Number, Meter Software Revision, Date, Time, Channel Number, Electrode ID, Sample ID, User ID, Module Serial Number, Mode, Conductivity Value, Conductivity Unit, Conductance Value, Conductance Unit, Temperature Value, Temperature Unit, Temperature Coefficient Value, Temperature Coefficient Unit, Temperature Reference Value, Temperature Reference Unit, Cell Constant Value, Cell Constant Unit, Method Number</p> <p>Example: Versa Star Pro, V11702, 11.20, 29-03-18, 3:50:53 PM, Ch-3, SENSOR-03, 1, ADMIN, VA12345, Conductivity, 100.0, uS/cm, 99.982, uS, 25.0, C (ATC), 2.1, %/C, 25.0, C, 1.0010, /cm, M301 <CR></p>
TDS	<p>Meter Type, Meter Serial Number, Meter Software Revision, Date, Time, Channel Number, Electrode ID, Sample ID, User ID, Module Serial Number, Mode, TDS Value, TDS Unit, Conductance Value, Conductance Unit, Temperature Value, Temperature Unit, Temperature Coefficient Value, Temperature Coefficient Unit, Temperature Reference Value, Temperature Reference Unit, TDS Factor, Cell Constant Value, Cell Constant Unit, Method Number</p> <p>Example: Versa Star Pro, V11702, 11.20, 29-03-18, 3:50:53 PM, Ch-3, SENSOR-03, 1, ADMIN, VA12345, TDS, 49.04, ppm, 99.982, uS, 25.0, C (ATC), 2.1, %/C, 25.0, C, 0.49, 1.0010, /cm, M301 <CR></p>

Mode	Format Example
Salinity	<p>Meter Type, Meter Serial Number, Meter Software Revision, Date, Time, Channel Number, Electrode ID, Sample ID, User ID, Module Serial Number, Mode, Salinity Value, Salinity Unit, Conductance Value, Conductance Unit, Temperature Value, Temperature Unit, Salinity Type, Temperature Reference Value, Temperature Reference Unit, Cell Constant Value, Cell Constant Unit, Method Number</p> <p>Example: Versa Star Pro, V11702, 11.20, 29-03-18, 3:50:53 PM, Ch-3, SENSOR-03, 1, ADMIN, VA12345, Salinity, 0.052, psu, 99.982, uS, 25.0, C (ATC), 15.0, C, 1.0010, /cm, M301 <CR></p>
Resistivity	<p>Meter Type, Meter Serial Number, Meter Software Revision, Date, Time, Channel Number, Electrode ID, Sample ID, User ID, Module Serial Number, Mode, Resistivity Value, Resistivity Unit, Conductance Value, Conductance Unit, Temperature Value, Temperature Unit, Temperature Coefficient Value, Temperature Coefficient Unit, Temperature Reference Value, Temperature Reference Unit, Cell Constant Value, Cell Constant Unit, Method Number</p> <p>Example: Versa Star Pro, V11702, 11.20, 29-03-18, 3:50:53 PM, Ch-3, SENSOR-03, 1, ADMIN, VA12345, Resistivity, 9.992, KOhm-cm, 99.982, uS, 25.0, C (ATC), 2.1, %/C, 25.0, C, 1.0010, /cm, M301 <CR></p>
DO %	<p>Meter Type, Meter Serial Number, Meter Software Revision, Date, Time, Channel Number, Electrode ID, Sample ID, User ID, Module Serial Number, Mode, DO Saturation Value, DO Saturation Unit, DO Concentration Value, DO Concentration Unit, Current Value, Current Unit, Solution Temperature Value, Solution Temperature Unit, Membrane Temperature Value, Membrane Temperature Unit, Barometric Pressure Value, Barometric Pressure Unit, Salinity Correction Value in ppt, Slope Value, Slope Unit, Method Number</p> <p>Example: Versa Star Pro, V11702, 11.20, 29-03-18, 3:50:53 PM, Ch-4, SENSOR-04, 1, ADMIN, VA12345, DO, 102.0, %, 8.59, mg/L, 1331.38, nA, 24.5, C (ATC), 24.6, C (ATC), 760.2, mmHg, 0.1, 11.8, nA/%sat, M401 <CR></p>
DO mg/L	<p>Meter Type, Meter Serial Number, Meter Software Revision, Date, Time, Channel Number, Electrode ID, Sample ID, User ID, Module Serial Number, Mode, DO Concentration Value, DO Concentration Unit, DO Saturation Value, DO Saturation Unit, Current Value, Current Unit, Solution Temperature Value, Solution Temperature Unit, Membrane Temperature Value, Membrane Temperature Unit, Barometric Pressure Value, Barometric Pressure Unit, Salinity Correction Value in ppt, Slope Value, Slope Unit, Method Number</p> <p>Example: Versa Star Pro, V11702, 11.20, 29-03-18, 3:50:53 PM, Ch-4, SENSOR-04, 1, ADMIN, VA12345, DO, 8.59, mg/L, 102.0, %, 1331.38, nA, 24.5, C (ATC), 24.6, C (ATC), 760.2, mmHg, 0.1, 11.8, nA/%sat, M401 <CR></p>
RDO %	<p>Meter Type, Meter Serial Number, Meter Software Revision, Date, Time, Channel Number, Electrode ID, Sample ID, User ID, Module Serial Number, Mode, RDO Saturation Value, RDO Saturation Unit, RDO Concentration Value, RDO Concentration Unit, Partial Pressure in Torr, Solution Temperature Value, Solution Temperature Unit, Barometric Pressure Value, Barometric Pressure Unit, Salinity Correction Value in ppt, Slope Value, Slope Unit, Method Number</p> <p>Example: Versa Star Pro, V11702, 11.20, 29-03-18, 3:50:53 PM, Ch-4, SENSOR-04, 1, ADMIN, VA12345, RDO, 102.0, %, 8.59, mg/L, 150.052, 24.3, C (ATC), 760.2, mmHg, 0.1, 1.6, Torr/%Sat, M401 <CR></p>

Mode	Format Example
RDO mg/L	<p>Meter Type, Meter Serial Number, Meter Software Revision, Date, Time, Channel Number, Electrode ID, Sample ID, User ID, Module Serial Number, Mode, RDO Concentration Value, RDO Concentration Unit, RDO Saturation Value, RDO Saturation Unit, Partial Pressure in Torr, Solution Temperature Value, Solution Temperature Unit, Barometric Pressure Value, Barometric Pressure Unit, Salinity Correction Value in ppt, Slope Value, Slope Unit, Method Number</p> <p>Example: Versa Star Pro, V11702, 11.20, 29-03-18, 3:50:53 PM, Ch-4, SENSOR-04, 1, ADMIN, VA12345, RDO, 8.59, mg/L, 102.0, %, 150.052, 24.3, C (ATC), 760.2, mmHg, 0.1, 1.6, Torr/%Sat, M401 <CR></p>
Multiple Channels	<p>Meter Type, Meter Serial Number, Meter Software Revision, Date, Time followed by the measurement data for each channel as shown above</p>

Meter Calibration Data Example

Mode	Format Example
pH	<p>Meter Type, Meter Serial Number, Meter Software Revision, Channel Number, Electrode ID, Module Serial Number, Method Number, Calibration Date, Calibration Time, User ID, Total Calibration Points,</p> <p><i>(repeated for each calibration point)</i> Calibration Point Number, pH Unit, pH Value, mV Unit, mV Value, Temperature Value, Temperature Unit, Calibration Type,</p> <p><i>(repeated for each point-to-point segment)</i> Segment Number, Slope Value, Slope Unit, <i>(repeated for each point-to-point segment)</i> Segment Number, Offset Value, Offset Unit, Average Slope Value, Average Slope Unit, Calibration Log Number</p> <p>Example (5 point calibration): VERSA STAR, V00000, 2.73, Ch-1, SENSOR-01, VA12345, M-101, 15-03-14, 1:30:30 PM, USER-01, 5, 1, pH, 1.678, mV, 290.4, 25.0, C (MAN), Auto, 2, pH, 4.01, mV, 174.3, 25.0, C (MAN), Auto, 3, pH, 6.997, mV, 0.0, 25.0, C (MAN), Auto, 4, pH, 10.013, mV, -173.7, 25.0, C (MAN), Auto, 5, pH, 12.46, mV, -289.5, 25.0, C (MAN), Auto, 1, -49.8, mV, 2, -58.4, mV, 3, -57.6, mV, 4, -47.3, mV, 1, 25.4, mV, 2, -0.2, mV, 3, -0.2, mV, 4, -31.1, mV, 90.0, %, 101 <CR></p>
RmV	<p>Meter Type, Meter Serial Number, Meter Software Revision, Channel Number, Electrode ID, Module Serial Number, Method Number, Calibration Date, Calibration Time, User ID, Relative mV Value, Relative mV Unit, Raw mV Value, Raw mV Unit, Temperature Value, Temperature Unit, Relative mV Offset Value, Relative mV Offset Unit, Calibration Log Number</p> <p>Example: VERSA STAR, V00000, 2.73, Ch-1, SENSOR-01, VA12345, M-101, 15-03-14, 1:30:30 PM, USER-01, 199.8, RmV, 199.7, mV, 25.0, C (MAN), 0.1, mV, 101 <CR></p>
ORP	<p>Meter Type, Meter Serial Number, Meter Software Revision, Channel Number, Electrode ID, Module Serial Number, Method Number, Calibration Date, Calibration Time, User ID, ORP Value, ORP Unit, Raw mV Value, Raw mV Unit, Temperature Value, Temperature Unit, ORP Offset Value, ORP Offset Unit, Calibration Log Number</p> <p>Example: VERSA STAR, V00000, 2.73, Ch-1, SENSOR-01, VA12345, M-101, 15-03-14, 1:30:30 PM, USER-01, 419.5, RmV, 199.8, mV, 25.0, C (MAN), 219.7, mV, 101 <CR></p>
ISE	<p>Meter Type, Meter Serial Number, Meter Software Revision, Channel Number, Electrode ID, Electrode Type, Module Serial Number, Method Number, Calibration Date, Calibration Time, User ID, Total Calibration Points,</p> <p><i>(repeated for each calibration point)</i> Calibration Point Number, Concentration Value, Concentration Unit, mV Value, mV Unit, Temperature Value, Temperature Unit, Calibration Type,</p> <p><i>(repeated for each point-to-point segment)</i> Segment Number, Slope Value, Slope Unit, <i>(repeated for each point-to-point segment)</i> Segment Number, Offset Value, Offset Unit, Average Slope Value, Average Slope Unit, Blank Function, Blank Value, Blank Unit, Calibration Log Number</p> <p>Example (5 point calibration): VERSA STAR, V00000, 2.73, Ch-2, SENSOR-02, F-, VA12345, M-201, 15-03-14, 1:30:30 PM, USER-01, 5, 1, 0.1, ppm, 174.2, mV, 25.0, C (MAN), Manual, 2, 1, ppm, 116.2, mV, 25.0, C (MAN), Manual, 3, 10, ppm, 58.0, mV, 25.0, C (MAN), Manual, 4, 100, ppm, 0.0, mV, 25.0, C (MAN), Manual, 5, 1000, ppm, -57.8, mV, 25.0, C (MAN), Manual, 1, -58.0, mV/dec, 2, -58.2, mV/dec, 3, -58.0, mV/dec, 4, -57.8, mV/dec, 1, 116.2, mV, 2, 116.2, mV, 3, 116.0, mV, 4, 115.6, mV, -58.0, mV/dec, 0, 0.000, ppm, 201 <CR></p>

Mode	Format Example
Incremental Technique (Single Known Addition and Single Known Subtraction)	<p>Meter Type, Meter Serial Number, Meter Software Revision, Channel Number, Electrode ID, Electrode Type, Module Serial Number, Method Number, Calibration Date, Calibration Time, User ID, Incremental Type, Slope Value, Slope Unit, Sample Volume Value, Sample Volume Unit, Total Volume Value, Total Volume Unit, Standard Concentration Value, Standard Concentration Unit, Reaction Ratio (<i>known subtraction only</i>), Measured Sample Value, Measured Sample Unit, Standard Volume Value, Standard Volume Unit, Measured Sample and Standard Value, Measured Sample and Standard Unit, Temperature Value, Temperature Unit, Calculated Concentration Value, Calculated Concentration Unit, Calibration Log Number</p> <p>Example: VERSA STAR, V00000, 2.73, Ch-2, SENSOR-02, F-, VA12345, M-201, 15-03-14, 1:30:30 PM, USER-01, Single Known Addition, -59.2, mV/dec, 100.000, mL, 102.000, mL, 100.000, ppm, 0.0, mV, 1.000, mL, -57.8, mV, 25.0, C (MAN), 0.117, ppm, 201 <CR></p> <p>Example: VERSA STAR, V00000, 2.73, Ch-2, SENSOR-02, F-, VA12345, M-201, 15-03-14, 1:30:30 PM, USER-01, Single Known Subtraction, -59.2, mV/dec, 100.000, mL, 102.000, mL, 0.100, molar, 0.500, 0.0, mV, 5.000, mL, 58.0, mV, 25.0, C (MAN), 0.00281, molar, 202 <CR></p>
Incremental Technique (Double Known Addition and Double Known Subtraction)	<p>Meter Type, Meter Serial Number, Meter Software Revision, Channel Number, Electrode ID, Electrode Type, Module Serial Number, Method Number, Calibration Date, Calibration Time, User ID, Incremental Type, Slope Value, Slope Unit, Sample Volume Value, Sample Volume Unit, Total Volume Value, Total Volume Unit, Standard Concentration Value, Standard Concentration Unit, Reaction Ratio (<i>known subtraction only</i>), Measured Sample Value, Measured Sample Unit, First Standard Volume Value, First Standard Volume Unit, Measured Sample and First Standard Value, Measured Sample and First Standard Unit, Second Standard Volume Value, Second Standard Volume Unit, Measured Sample and Second Standard Value, Measured Sample and Second Standard Unit, Temperature Value, Temperature Unit, Calculated Concentration Value, Calculated Concentration Unit, Calibration Log Number</p> <p>Example: VERSA STAR, V00000, 2.73, Ch-2, SENSOR-02, F-, VA12345, M-201, 15-03-14, 1:30:30 PM, USER-01, Double Known Addition, -58.0, mV/dec, 100.000, mL, 102.000, mL, 100.000, ppm, 0.0, mV, 1.000, mL, -17.8, mV, 10.000, mL, -63.3, mV, 25.0, C (MAN), 1.040, ppm, 203 <CR></p> <p>Example: VERSA STAR, V00000, 2.73, Ch-2, SENSOR-02, F-, VA12345, M-201, 15-03-14, 1:30:30 PM, USER-01, Double Known Subtraction, -58.0, mV/dec, 100.000, mL, 102.000, mL, 0.100, molar, 0.500, 0.0, mV, 1.000, mL, 8.9, mV, 10.000, mL, 32.3, mV, 25.0, C (MAN), 0.00140, molar, 204 <CR></p>
Conductivity	<p>Meter Type, Meter Serial Number, Meter Software Revision, Channel Number, Electrode ID, Module Serial Number, Method Number, Calibration Date, Calibration Time, User ID, Total Calibration Points, (repeated for each calibration point) Calibration Point Number, Conductivity Value, Conductivity Unit, Conductance Value, Conductance Unit, Temperature Value, Temperature Unit, Calibration Type, (repeated for each calibration point) Calibration Point Number, Cell Constant Value, Cell Constant Unit, Average Cell Constant Value, Average Cell Constant Unit, Calibration Log Number</p> <p>Example (1 point calibration): VERSA STAR, V00000, 2.73, Ch-3, SENSOR-03, VA12345, M-301, 15-03-14, 1:30:30 PM, USER-01, 1, 1, 100.0, uS/cm, 99.98, uS, 25.0, C (MAN), Auto, 1, 1.0010, /cm, 1.0010, /cm, 1, 0.00, uS/cm, 301 <CR></p>

Mode	Format Example
DO	<p>Meter Type, Meter Serial Number, Meter Software Revision, Channel Number, Electrode ID, Module Serial Number, Method Number, Calibration Date, Calibration Time, User ID, Calibration Value, Calibration Unit, Calibration Current Value, Calibration Current Units, Set Zero Calibration Current Value, Set Zero Calibration Current Units, Solution Temperature Value, Solution Temperature Unit, Membrane Temperature Value, Membrane Temperature Unit, Calibration Type, Barometric Pressure Value, Barometric Pressure Unit, Slope Value, Slope Unit, Calibration Log Number</p> <p>Example: VERSA STAR, V00000, 2.73, Ch-4, SENSOR-04, VA12345, M-401, 15-03-14, 1:30:30 PM, USER-01, 102.3, %, 1334.9, nA, 0.0, nA, 23.8, C (ATC), 24.0, C (ATC), Auto, 760.0, mmHg, 13.0, nA/%sat, 401 <CR></p>
RDO	<p>Meter Type, Meter Serial Number, Meter Software Revision, Channel Number, Electrode ID, Module Serial Number, Method Number, Calibration Date, Calibration Time, User ID, Calibration Value, Calibration Unit, Partial Pressure in Torr, Set Zero Calibration Value, Set Zero Calibration Units, Solution Temperature Value, Solution Temperature Unit, Calibration Type, Barometric Pressure Value, Barometric Pressure Unit, Slope Value, Slope Unit, Calibration Log Number</p> <p>Example: VERSA STAR, V00000, 2.73, Ch-4, SENSOR-04, VA12345, M-401, 15-03-14, 1:30:30 PM, USER-01, 102.3, %, 0.0, %, 0.0, nA, 23.8, C (ATC), Auto, 760.0, mmHg, 1.6, Torr/%Sat, 402 <CR></p>

9

Chapter 9 **Customer Services**

Please visit www.thermofisher.com/water for more information and downloadable content on the Thermo Scientific Orion meter, electrode and solution products.

For any questions or if you require assistance, please contact your local Technical Sales Representative, Product Specialist or Technical Support Team.

Americas Technical Support Team

- Phone: 1-978-232-6000
- US Toll-free Phone: 1-800-225-1480 (US toll-free)
- Email: wlp.techsupport@thermofisher.com

EMEA Technical Support Team

- Phone: 0049 6184 90 6321
- Free hotline from D, A, CH, F, UK, IRL: 00800 1234 9696
- Email: techsupport.labproducts.eu@thermofisher.com

APAC Technical Support Team

- Phone: (65) 6778-6876
- Email: customerservice.sg.wai@thermofisher.com

Troubleshooting Tips

If an issue is encountered while using the Versa Star Pro meter with measurement modules, ensure the correct power adapter is being used and try power cycling the meter: disconnect the power adapter from the meter, wait 15 seconds and reconnect the power adapter to the meter. Perform a factory reset on the meter; refer to the [Diagnostics Menu](#) section for instructions.

Meter Issue	Recommended Action
The meter shows the message: Module not detected ... Plug in module to start measurement.	Insert at least one module into an open channel on the meter, once the module is detected, the meter will display the main measurement screen for that measurement module.
The channel ID icon does not show that a measurement module is connected.	Check that the module is properly connected with an open channel on the meter. Remove the module and reinsert it into a different channel. Perform a factor reset on the meter; refer to the Diagnostics Menu section for instructions.
The measurement value is flashing 9999 and displaying Over Range or Under Range	The measurement is outside the allowable measurement range. Make sure the electrode or probe is fully connected with the measurement module and verify the correct channel is shown on the meter display.
The meter locks up while connected to a computer via the USB cable.	Disconnect the USB cable from the meter and computer and then disconnect and reconnect the power adapter from the meter. Reestablish the meter and computer USB connection.
The measurement value freezes and will not change.	The read type is set to Auto-Read mode (AR icon shown on the display). Press the measure (esc) key to take a new measurement or use the setup menu to change the read type to continuous.
The meter display goes blank, shows random lines or intermittently freezes.	Ensure the correct power supply for the Versa Star Pro meter is being used. This power supply is different from the one supplied with other Thermo Scientific Orion meters. The use of a surge protector or uninterrupted power supply (UPS) is also recommended. Perform a factor reset on the meter; refer to the Diagnostics Menu section for instructions.
The meter does not automatically recognize the pH buffer during calibration.	Verify the correct buffer set was selected in the setup menu. The meter uses raw mV readings to recognize the buffer. As the electrode ages or becomes dirty, its mV readings will drift. Check the buffers and clean the electrode according to the instructions in the electrode manual.
The meter does not recognize the conductivity standard during calibration.	Verify that the correct nominal cell constant is entered in the setup menu for the conductivity probe being calibrated. The cell constant is usually printed on the cable of the conductivity probe. Verify that the conductivity standard is one that can be automatically recognized by the meter. Recalibrate the conductivity probe using new conductivity standard.
The meter does not recognize an RDO optical or polarographic DO probe.	Make sure the DO probe is fully connected with the measurement module and verify the correct channel is shown on the meter display. Wait about 15 seconds after connecting a DO probe for the meter to recognize the DO probe type. Press the measure (esc) key to initiate a new measurement and update the meter display.

Meter Self-Test

1. In the measurement mode, press the **setup** key.
2. Press the ◀ or ▶ key to highlight Diagnostics and press the **f3 (Select)** key.
3. Press the ▲ or ▼ key to highlight Self Test and press the **f3 (Select)** key.
4. Press the ▲ or ▼ key to highlight Keypad Check and press the **f3 (Select)** key.
 - a. Press all keys on the meter keypad one at a time to complete the test. Each key icon on the meter display will turn green when the corresponding key has been pressed.
 - b. When all keys have been successfully pressed, the meter will display the message that the keypad check is complete and the meter will return to the Self Test menu.
5. Press the ▲ or ▼ key to highlight Accuracy Check and press the **f3 (Select)** key.
 - a. Disconnect all of the electrodes and probes from the meter, attach the BNC shorting cap to all BNC inputs and press the **f3 (Start)** key to begin the test.
 - b. The test results for all channels with a module that has a BNC input will be displayed and **Pass** should be indicated for all channels. Press the **f1 (Back)** key to return to the Self Test menu.
 - c. If **Fail** is indicated for any channels, make sure the BNC shorting cap is properly connected to the BNC input and repeat the test. If “Fail” is indicated again, contact Technical Support.
6. Press the ▲ or ▼ key to highlight Stirrer Check and press the **f3 (Select)** key.
 - a. Connect an Orion Star stirrer probe (Catalog Number 096019) to the STIRRER 1 meter input and press the **f3 (Start)** key.
 - b. Visually check that the Orion Star stirrer probe is stirring and press the **f1 (Yes)** key.
 - c. Connect an Orion Star stirrer probe to the STIRRER 2 meter input and press the **f3 (Start)** key.
 - d. Visually check that the Orion Star stirrer probe is stirring and press the **f1 (Yes)** key.
 - e. The meter will display the message that the stirrer check is complete and the meter will return to the Self Test menu.
7. Press the **measure (esc)** key to proceed to the measurement mode.

WEEE Compliance

This product is required to comply with the European Union's Waste Electrical & Electronic Equipment (WEEE) Directive 2002/96/EC. It is marked with the symbol shown here.



Thermo Fisher Scientific has contracted with one or more recycling/disposal companies in each EU Member State and this product should be disposed of or recycled through them. Further information on compliance with these directives, the recyclers in your country, and information on Thermo Scientific Orion products that may assist the detection of substances subject to the RoHS Directive are available by contact us using the WLP information on the back page of this user manual.

Declaration of Conformity

Please visit our website for the latest version of this certificate.

Meter Specifications



Orion Versa Star Pro Meter Specifications	
Measurement Channels	1 to 4
Display	Color graphic LCD with customizable measurement font size
View Options	View 1 to 4 measurement channels simultaneously
Measurement Read Types	Auto-Read, Timed, Single-Shot, Continuous
Data Log Memory	2000 data points with time and date stamp
Data Log Functions	Automatic data logging with Auto-Read, Timed and Single-Shot read types; manual data logging with Continuous read type
Data Log Transfer	Transfer single, range or all data points to printer or computer
Data Log Editing	Delete individual data points or all data points
Calibration Log	30 calibrations per measure mode with time and date stamp
Computer Software	Orion Navigator Pro computer software, Cat. No.VSTAR-NPUSB
Methods	10 per channel, 40 total
Communication Ports	RS232, bidirectional USB B, printer-dedicated USB AB
Stirrer Probe Ports	2
Power Source	Universal AC power adapter, 90-260 VAC, 50-60 Hz

Orion Versa Star Pro Meter Operating Conditions	
Operating Ambient Temperature	5 to 45 °C
Operating Relative Humidity	5 to 85 %, non-condensing
Storage Temperature	-20 to 60 °C
Storage Relative Humidity	5 to 85 %, non-condensing
Pollution	Degree 2
Overvoltage	Category II
Weight, Meter	1.15 kg (2.5 lb)
Weight, Module	0.15 kg (0.3 lb) each
Meter Dimensions (H x W x D)	9.5 cm x 24.0 cm x 28.2 cm (3.75" x 9.45" x 11.1")
Regulatory and Safety	CE, TUV 3-in-1, FCC Class A
Power Rating	DC input: 9VDC, 1A
Shock and Vibration	Shock: drop test in packaging per ISTA #1A
	Vibration: shipping/handling per ISTA #1A
Enclosure (designed to meet)	IP54
Warranty	3 years

Universal Power Adapter Operating Conditions	
Operating Ambient Temperature	0 to 50 °C
Operating Relative Humidity	0 to 90 %, non-condensing
Storage Temperature	-20 to 75 °C
Storage Relative Humidity	0 to 90 %, non-condensing
Pollution	Degree 2
Overvoltage	Category II

Orion Versa Star pH Module Specifications		
Catalog Number		VSTAR-PH
pH	Range	- 2.000 to 20.000
	Resolution	0.1, 0.01, 0.001
	Relative Accuracy	± 0.002
	Calibration Points	Up to 6
	Calibration Editing	Yes
	Adjustable ISO Point	Yes
	Input Impedance	> 10 ¹² ohms
mV / RmV	Range	± 2000.0 mV
	Resolution	0.1 mV
	Relative Accuracy	± 0.2 mV or ± 0.05 % of reading, whichever is greater
	Relative mV Mode	Yes
	E _H ORP Mode	Yes
Temperature	Range	-5 to 105 °C, 22 to 221 °F
	Resolution	0.1 °C, 0.1 °F
	Relative Accuracy	± 0.1 °C, ± 0.1 °F
	Offset Calibration	1 point
	Source Options	Manual or automatic with ATC probe
Inputs	BNC	pH or ORP electrode
	Pin Tip	Reference electrode
	8 pin MiniDIN	ATC temperature probe

Orion Versa Star pH/ISE Module Specifications		
Catalog Number		VSTAR-ISE
pH	Range	- 2.000 to 20.000
	Resolution	0.1, 0.01, 0.001
	Relative Accuracy	± 0.002
	Calibration Points	Up to 6
	Calibration Editing	Yes
	Adjustable ISO Point	Yes
	Input Impedance	> 10 ¹² ohms
mV / RmV	Range	± 2000.0 mV
	Resolution	0.1 mV
	Relative Accuracy	± 0.2 mV or ± 0.05 % of reading, whichever is greater
	Relative mV Mode	Yes
	E _H ORP Mode	Yes
ISE	Range	0.0001 to 19990
	Resolution	0.0001 minimum, 1 to 4 significant digits (user selectable)
	Relative Accuracy	± 0.2 mV or ± 0.05 % of reading, whichever is greater
	Units	ppm, Molar, mg/L, %, ppb, none
	Calibration Points	Up to 6
	Calibration Editing	Yes
	Adjustable ISO Point	Yes
	Advanced Features	Segmented (point-to-point) slope or linear regression, non-linear selectable auto-blank, low concentration range stability, electrode type display, temperature compensation
	Incremental Techniques	Single known addition & subtraction, double known addition & subtraction, single analate addition & subtraction
Temperature	Range	-5 to 105 °C, 22 to 221 °F
	Resolution	0.1 °C, 0.1 °F
	Relative Accuracy	± 0.1 °C, ± 0.1 °F
	Offset Calibration	1 point
	Source Options	Manual or automatic with ATC probe
Inputs	BNC	pH, ORP or ion selective electrode (ISE)
	Pin Tip	Reference electrode
	8 pin MiniDIN	ATC temperature probe

Orion Versa Star pH/LogR Module Specifications		
Catalog Number		VSTAR-LR
pH	Range	- 2.000 to 20.000
	Resolution	0.1, 0.01, 0.001
	Relative Accuracy	± 0.002
	Calibration Points	Up to 6
	Calibration Editing	Yes
	Adjustable ISO Point	Yes
	Input Impedance	> 10 ¹² ohms
mV / RmV	Range	± 2000.0 mV
	Resolution	0.1 mV
	Relative Accuracy	± 0.2 mV or ± 0.05 % of reading, whichever is greater
	Relative mV Mode	Yes
	E _H ORP Mode	Yes
Temperature (manual or automatic with ATC probe)	Range	-5 to 105 °C, 22 to 221 °F
	Resolution	0.1 °C, 0.1 °F
	Relative Accuracy	± 0.1 °C, ± 0.1 °F
	Offset Calibration	1 point
	Source Options	Manual, automatic with ATC probe or LogR with pH electrode (see LogR temperature specifications)
Temperature (LogR)	Range	0 to 100 °C, 32 to 212 °F
	Resolution	0.1 °C, 0.1 °F
	Relative Accuracy	± 0.5 °C, ± 0.5 °F
	Resistance Range	0 to 6000 MΩ
	Resistance Resolution	0.1 MΩ up to 1999.9 MΩ, 1 MΩ above 1999.9 MΩ
	Offset Calibration	3 points
	Calibration Options	ATC probe, NIST reference
Inputs	BNC	pH or ORP electrode
	Pin Tip	Reference electrode
	8 pin MiniDIN	ATC temperature probe

Orion Versa Star Conductivity Module Specifications		
Catalog Number	VSTAR-CND	
Conductivity	Range	0.001 μ S to 3000 mS
	Resolution	0.001 μ S minimum, auto ranging, up to 4 significant digits
	Relative Accuracy	0.5 % of reading \pm 1 digit > 3 μ S, 0.5 % of reading \pm 0.01 μ S \leq 3 μ S
	Reference Temperature	5 °C, 10 °C, 15 °C, 20 °C, 25 °C
	Temperature Compensation	Linear (0 to 10.0 %/°C), nonlinear nLFn, nonlinear nLFu, EP (USP), off
	Compatible Cell Constants	0.001 to 199.9 cm ⁻¹
	Calibration Points	Up to 6
	Calibration Editing	Yes
TDS	Range	0.001 to 200.0 ppm
	Resolution	0.001 ppm minimum, auto ranging, up to 4 significant digits
	Relative Accuracy	0.5 % of reading \pm 1 digit
	TDS Factor	Linear (0.02 to 9.99) or ISO/EN 27888
Salinity	Range	0.06 to 80.00 psu, 0.05 to 42.00 ppt
	Resolution	0.01 psu or ppt minimum, auto ranging
	Relative Accuracy	0.5 % of reading \pm 1 digit
	Type	Practical salinity (psu) or natural sea water (ppt)
Resistivity	Range	2 Ω to 100 M Ω
	Resolution	1 Ω or 0.1 M Ω , auto ranging
	Relative Accuracy	0.5 % of reading \pm 1 digit
Temperature	Range	-5 to 105 °C, 22 to 221 °F
	Resolution	0.1 °C, 0.1 °F
	Relative Accuracy	\pm 0.1 °C, \pm 0.1 °F
	Offset Calibration	1 point
	Source Options	Manual or automatic with built-in temperature sensor
Input	8 pin MiniDIN	Conductivity probe with optional built-in temperature sensor

Orion Versa Star RDO/Dissolved Oxygen Module Specifications			
Catalog Number		VSTAR-RD	
Dissolved Oxygen	Polarographic DO	Concentration	% Saturation
	Range	0 to 90 mg/L	0 to 600 %
	Resolution	0.01, 0.1 mg/L	0.1, 1 %
	Relative Accuracy	± 0.2 mg/L	± 2 %
	RDO Optical DO	Concentration	% Saturation
	Range	0 to 50 mg/L	0 to 500 %
	Resolution	0.01, 0.1 mg/L	0.1, 1 %
	Relative Accuracy	± 0.1 mg /L up to 8 mg/L, ± 0.2 mg /L from 8 to 20 mg/L, ± 10 % of reading from 20 to 50 mg/L	± 2 %
	Barometric Pressure Correction	450 to 850 mmHg, automatic using built-in barometer or manual entry	
	Salinity Factor Correction	0 to 45 ppt, automatic using conductivity module and probe or manual entry	
	Calibration Types	Water saturated air, air saturated water, manual (Winkler), zero point	
	Compatible Sensors	Polarographic, RDO optical	
Barometric Pressure	Range	450.0 to 850.0 mmHg	
	Resolution	0.1 mmHg	
	Relative Accuracy	± 6 mmHg	
Temperature	Range	0 to 50 °C, 32 to 122 °F	
	Resolution	0.1 °C, 0.1 °F	
	Relative Accuracy	± 0.1 °C, ± 0.1 °F	
	Offset Calibration	1 point	
	Source Option	Automatic with built-in temperature sensor	
Input	9 pin MiniDIN	Dissolved oxygen probe with built-in temperature sensor	

Note: Specifications are subject to change without notice.

Ordering Information

Versa Star Pro Meters and Versa Star Modules

Cat. No.	Description
VSTAR00	Versa Star Pro meter with attached electrode stand, universal power adapter, literature CD, printed quick start guide, USB computer cable and meter test certificate
VSTAR-PH	Versa Star pH/mV/ORP/temperature measurement module
VSTAR-ISE	Versa Star pH/ISE/mV/ORP/temperature measurement module
VSTAR-LR	Versa Star pH/LogR/mV/ORP/temperature measurement module
VSTAR-CND	Versa Star conductivity/salinity/resistivity/TDS/temperature measurement module
VSTAR-RD	Versa Star dissolved oxygen/RDO/temperature measurement module

Cat. No.	Description
VSTAR10	Versa Star Pro meter with electrode stand, universal power adapter, literature, USB computer cable and meter test certificate <ul style="list-style-type: none"> Versa Star pH measurement module (VSTAR-PH)
VSTAR12	Versa Star Pro meter with electrode stand, universal power adapter, literature, USB computer cable and meter test certificate <ul style="list-style-type: none"> Versa Star pH measurement module (VSTAR-PH) 8302BNUMD ROSS Ultra Triode glass refillable pH/ATC electrode 096019 Meter-powered stirrer probe 810199 ROSS pH buffer and storage solution kit
VSTAR13	Versa Star Pro meter with electrode stand, universal power adapter, literature, USB computer cable and meter test certificate <ul style="list-style-type: none"> Versa Star pH measurement module (VSTAR-PH) 8172BNWP ROSS Sure-Flow glass refillable pH electrode 927007MD Stainless steel ATC temperature probe 096019 Meter-powered stirrer probe 810199 ROSS pH buffer and storage solution kit
VSTAR20	Versa Star Pro meter with electrode stand, universal power adapter, literature, USB computer cable and meter test certificate <ul style="list-style-type: none"> Versa Star conductivity measurement module (VSTAR-CND)
VSTAR22	Versa Star Pro meter with electrode stand, universal power adapter, literature, USB computer cable and meter test certificate <ul style="list-style-type: none"> Versa Star conductivity measurement module (VSTAR-CND) 013005MD DuraProbe epoxy 4-cell (K=0.475) conductivity probe 011007 1413μS conductivity standard, 5 x 60 mL
VSTAR23	Versa Star Pro meter with electrode stand, universal power adapter, literature, USB computer cable and meter test certificate <ul style="list-style-type: none"> Versa Star conductivity measurement module (VSTAR-CND) 013016MD Pure Water 2-cell (K=0.1) conductivity probe 011008 100μS conductivity standard, 5 x 60 mL

Cat. No.	Description
VSTAR30	Versa Star Pro meter with electrode stand, universal power adapter, literature, USB computer cable and meter test certificate <ul style="list-style-type: none"> • Versa Star RDO/DO measurement module (VSTAR-RD)
VSTAR32	Versa Star Pro meter with electrode stand, universal power adapter, literature, USB computer cable and meter test certificate <ul style="list-style-type: none"> • Versa Star RDO/DO measurement module (VSTAR-RD) • 083005MD Polarographic DO probe with calibration sleeve • 080513 DO probe maintenance kit • BOD adapter, funnel and stirrer
VSTAR40A	Versa Star Pro meter with electrode stand, universal power adapter, literature, USB computer cable and meter test certificate <ul style="list-style-type: none"> • Versa Star pH/ISE measurement module (VSTAR-ISE)
VSTAR40A2	Versa Star Pro meter with electrode stand, universal power adapter, literature, USB computer cable and meter test certificate <ul style="list-style-type: none"> • Versa Star pH/ISE measurement module (VSTAR-ISE) • 8102BNUWP ROSS Ultra glass refillable pH electrode • 927007MD Stainless steel ATC temperature probe • 096019 Meter-powered stirrer probe • 810199 ROSS pH buffer and storage solution kit
VSTAR40B	Versa Star Pro meter with electrode stand, universal power adapter, literature, USB computer cable and meter test certificate <ul style="list-style-type: none"> • 2 Versa Star pH/ISE measurement modules (2 x VSTAR-ISE)
VSTAR40B2	Versa Star Pro meter with 2 electrode stands, universal power adapter, literature, USB computer cable and meter test certificate <ul style="list-style-type: none"> • 2 Versa Star pH/ISE measurement modules (2 x VSTAR-ISE) • 8102BNUWP ROSS Ultra glass refillable pH electrode • 927007MD Stainless steel ATC temperature probe • 096019 Meter-powered stirrer probe • 810199 ROSS pH buffer and storage solution kit
VSTAR50	Versa Star Pro meter with electrode stand, universal power adapter, literature, USB computer cable and meter test certificate <ul style="list-style-type: none"> • Versa Star pH measurement module (VSTAR-PH) • Versa Star conductivity measurement module (VSTAR-CND)
VSTAR52	Versa Star Pro meter with electrode stand, universal power adapter, literature, USB computer cable and meter test certificate <ul style="list-style-type: none"> • Versa Star pH measurement module (VSTAR-PH) • Versa Star conductivity measurement module (VSTAR-CND) • 8157BNUMD ROSS Ultra Triode epoxy refillable pH/ATC electrode • 013005MD DuraProbe epoxy 4-cell (K=0.475) conductivity probe • 810199 ROSS pH buffer and storage solution kit • 011007 1413μS conductivity standard, 5 x 60 mL

Cat. No.	Description
VSTAR80	Versa Star Pro meter with electrode stand, universal power adapter, literature, USB computer cable and meter test certificate <ul style="list-style-type: none"> • Versa Star pH/LogR measurement module (VSTAR-LR) • 927007MD Stainless steel ATC temperature probe
VSTAR82	Versa Star Pro meter with electrode stand, universal power adapter, literature, USB computer cable and meter test certificate <ul style="list-style-type: none"> • Versa Star pH/LogR measurement module (VSTAR-LR) • 8172BNWP ROSS Sure-Flow glass refillable pH electrode • 927007MD Stainless steel ATC temperature probe • 810199 ROSS pH buffer and storage solution kit • 810007 ROSS electrode fill solution
VSTAR83	Versa Star Pro meter with electrode stand, universal power adapter, literature, USB computer cable and meter test certificate <ul style="list-style-type: none"> • Versa Star pH/LogR measurement module (VSTAR-LR) • 8220BNWP ROSS Micro glass refillable pH electrode • 927007MD Stainless steel ATC temperature probe • 810199 ROSS pH buffer and storage solution kit
VSTAR90	Versa Star Pro meter with electrode stand, universal power adapter, literature, USB computer cable and meter test certificate <ul style="list-style-type: none"> • Versa Star pH/ISE measurement module (VSTAR-ISE) • Versa Star conductivity measurement module (VSTAR-CND) • Versa Star RDO/DO measurement module (VSTAR-RD)
VSTAR91	Versa Star Pro meter with electrode stand, universal power adapter, literature, USB computer cable and meter test certificate <ul style="list-style-type: none"> • 2 Versa Star pH/ISE measurement modules (2 x VSTAR-ISE) • Versa Star conductivity measurement module (VSTAR-CND) • Versa Star RDO/DO measurement module (VSTAR-RD)
VSTAR92	Versa Star Pro meter with electrode stand, universal power adapter, literature, USB computer cable and meter test certificate <ul style="list-style-type: none"> • Versa Star pH/ISE measurement module (VSTAR-ISE) • Versa Star conductivity measurement module (VSTAR-CND) • Versa Star RDO/DO measurement module (VSTAR-RD) • 8157BNUMD ROSS Ultra Triode epoxy refillable pH/ATC electrode • 013005MD DuraProbe epoxy 4-cell (K=0.475) conductivity probe • 083005MD Polarographic DO probe with calibration sleeve • 096019 Meter-powered stirrer probe • 810199 ROSS pH buffer and storage solution kit • 011007 1413μS conductivity standard, 5 x 60 mL • 080513 DO probe maintenance kit • BOD adapter, funnel and stirrer

Cat. No.	Description
VSTAR93	<p>Versa Star Pro meter with electrode stand, universal power adapter, literature, USB computer cable and meter test certificate</p> <ul style="list-style-type: none"> • 2 Versa Star pH/ISE measurement modules (2 x VSTAR-ISE) • Versa Star conductivity measurement module (VSTAR-CND) • Versa Star RDO/DO measurement module (VSTAR-RD) • 8157BNUMD ROSS Ultra epoxy refillable pH/ATC electrode • 013005MD DuraProbe epoxy 4-cell (K=0.475) conductivity probe • 083005MD Polarographic DO probe with calibration sleeve • 096019 Meter-powered stirrer probe • 810199 ROSS pH buffer and storage solution kit • 011007 1413μS conductivity standard, 5 x 60 mL • 080513 DO probe maintenance kit • BOD adapter, funnel and stirrer
VSTAR94	<p>Versa Star Pro meter with electrode stand, universal power adapter, literature, USB computer cable and meter test certificate</p> <ul style="list-style-type: none"> • Versa Star pH/ISE measurement module (VSTAR-ISE) • Versa Star conductivity measurement module (VSTAR-CND) • Versa Star RDO/DO measurement module (VSTAR-RD) • 8157BNUMD ROSS Ultra Triode epoxy refillable pH/ATC electrode • 013005MD DuraProbe epoxy 4-cell (K=0.475) conductivity probe • 087010 RDO Optical DO probe with calibration sleeve and stainless steel guard • 096019 Meter-powered stirrer probe • 810199 ROSS pH buffer and storage solution kit • 011007 1413μS conductivity standard, 5 x 60 mL

Versa Star Pro Meter Accessories, Electrodes and Solutions

Cat. No.	Description
IQOQ-VSTAR	Versa Star Pro meter IQ/OQ (installation qualification / operation qualification) documentation, valid for all Versa Star Pro meter and module configurations
STARA-BEA	Star A and Versa Star Pro benchtop meter-attachable electrode stand, includes electrode arm, holder and meter bracket
STARA-HB	Freestanding weighted base for use with Star A and Versa Star Pro electrode stand
STARA-PWR	Universal power adapter for Versa Star Pro meters
1010053	Star series RS232 computer cable
STARA-106	Star A series ink-ribbon printer, 100-240V, with meter-to-printer cable
096019	Orion Star stirrer probe, pin tip connector
927007MD	Orion ATC temperature probe with stainless steel body, MiniDIN connector
928007MD	Orion micro ATC temperature probe with stainless steel tip, MiniDIN connector
8102BNUWP	ROSS Ultra glass-body refillable pH electrode, BNC connector
8156BNUWP	ROSS Ultra epoxy-body refillable pH electrode, BNC connector
8172BNWP	ROSS Sure-Flow glass-body refillable pH electrode, BNC connector
8165BNWP	ROSS Sure-Flow epoxy-body refillable pH electrode, BNC connector
8302BNUMD	ROSS Ultra Triode glass-body refillable pH/ATC electrode, BNC & MiniDIN connectors
8157BNUMD	ROSS Ultra Triode epoxy-body refillable pH/ATC electrode, BNC & MiniDIN connectors
8107BNUMD	ROSS Ultra Triode epoxy-body gel-filled pH/ATC electrode, BNC & MiniDIN connectors
8135BNUWP	ROSS Ultra epoxy-body refillable pH electrode with flat surface bulb, BNC connector
8163BNWP	ROSS spear tip glass-body refillable pH electrode, BNC connector
8103BNUWP	ROSS Ultra semi-micro glass-body refillable pH electrode, BNC connector
8115BNUWP	ROSS Ultra semi-micro epoxy-body refillable pH electrode, BNC connector
8220BNWP	ROSS micro glass-body refillable pH electrode, BNC connector
810199	ROSS All-in-One pH buffer and storage solution kit, includes pH 4, 7, 10 buffers; ROSS storage solution; pH electrode cleaning solution; pH electrode storage bottle
810001	ROSS pH electrode storage solution, 475 mL
910001	Standard pH electrode storage solution, 475 mL
910168	Orion pH 1.68 buffer, 475 mL
910104	Orion pH 4.01 buffer, 475 mL
910105	Orion pH 5.00 buffer, 475 mL
910686	Orion pH 6.86 buffer, 475 mL
910107	Orion pH 7.00 buffer, 475 mL
910918	Orion pH 9.18 buffer, 475 mL
910110	Orion pH 10.01 buffer, 475 mL
910112	Orion pH 12.46 buffer, 475 mL

Cat. No.	Description
9678BNWP	Orion Sure-Flow ORP epoxy-body refillable electrode, BNC connector
9180BNMD	Orion Triode ORP/ATC epoxy-body refillable electrode, BNC & MiniDIN connectors
967901	Orion ORP standard solution, 475 mL
9512HPBNWP	Orion high-performance ammonia ion selective electrode, BNC connector
9512BNWP	Orion standard ammonia ion selective electrode, BNC connector
951007	Orion 1000 ppm ammonia standard, 475 mL
951211	Orion ammonia ionic strength adjuster (ISA) with pH-indicating blue dye, 475 mL
951210	Orion low level ammonia ISA with pH-indicating blue dye, 475 mL
9617BNWP	Orion chloride ion selective electrode, BNC connector
941708	Orion 1000 ppm chloride standard, 475 mL
940011	Orion chloride ionic strength adjuster (ISA), 475 mL
9609BNWP	Orion fluoride ion selective electrode, BNC connector
940907	Orion 100 ppm fluoride standard, 475 mL
940909	Orion TISAB II total ionic strength adjustment buffer for fluoride analysis, 3.8 L
040906	Orion 1 ppm fluoride standard premixed with TISAB II, 475 mL
040907	Orion 2 ppm fluoride standard premixed with TISAB II, 475 mL
040908	Orion 10 ppm fluoride standard premixed with TISAB II, 475 mL
9707BNWP	Orion nitrate ion selective electrode, BNC connector
920707	Orion 1000 ppm nitrate standard, 475 mL
930711	Orion nitrate ionic strength adjuster (ISA), 475 mL
930710	Orion nitrate interference suppressor solution, 475 mL
8611BNWP	ROSS sodium ion selective electrode, BNC connector
841108	Orion 1000 ppm sodium standard, 475 mL
841111	Orion sodium ionic strength adjuster (ISA), 475 mL
013005MD	Orion DuraProbe 4-cell (K=0.475) conductivity/temperature probe, MiniDIN connector
013016MD	Orion UPW 2-cell (K=0.1) conductivity/temperature probe, MiniDIN connector
018020MD	Orion high range 2-cell conductivity probe (K=10), MiniDIN connector
011008	Orion 100 μ S/cm conductivity standard, 5 x 60 mL
011007	Orion 1413 μ S/cm conductivity standard, 5 x 60 mL
1010001	Orion conductivity verification resistor kit
083005MD	Orion polarographic DO probe with calibration sleeve, MiniDIN connector
086030MD	Orion Auto-Stir BOD polarographic probe with calibration sleeve, MiniDIN connector
087010MD	Orion RDO optical DO probe with optical cap, calibration sleeve and stainless steel probe guard, MiniDIN connector



Appendix A **Channel Specific Settings and Features**

Within the Channel 1, Channel 2, Channel 3 and Channel 4 setup menus is the Mode menu, which can be used to customize measurement settings and parameters for the selected channel. This section provides detailed information on the options available within Mode menus when using the various Versa Star measurement modules. Detailed information on additional advanced meter features is also provided.

General Mode Settings

Sample ID

If Manual is selected as the type of Sample ID, use the popup alphanumeric keypad screen to enter a sample ID up to ten characters long. The entered sample ID will be recorded with subsequent measurements and saved to the data log or exported to an external device, depending on the meter communication settings in the [Instrument Settings](#) setup menu.

If Auto Incremental is selected as the type of Sample ID, use the popup numeric keypad screen to enter a numeric value up to ten characters long. The entered sample ID will be used as the starting value and the meter will automatically increase the value by one for each subsequent measurement. The sample IDs will be recorded with each measurement and saved to the data log or exported to an external device, depending on the meter communication settings in the [Instrument Settings](#) setup menu.

Press the **f2 (Sample ID)** key in the measurement mode to open a shortcut to the Sample ID setup menu and enter a new sample ID.

Stability

The Stability setting allows the operator to set when a measurement is recognized as stable by the meter. When the Smart option is selected, the measurement resolution in conjunction with an algorithm that evaluates measurement fluctuations are used to determine when the measurement value is stable. When the Fast, Medium or Slow option is selected, only the algorithm is used to determine when the measurement value is stable. Approximate mV per minute values, estimated based on ideal measurement conditions, are shown below. These values are theoretical examples only and actual mV per minute fluctuations will vary based on individual measurement conditions.

Stability Setting	Approximate mV per Minute Fluctuation
Smart Stability	
0.1 resolution or 1 significant digit	7.6
0.01 resolution or 2 significant digits	2.9
0.001 resolution or 3 significant digit	1.0
0.0001 resolution or 4 significant digit	0.4
Fast Stability	7.6
Medium Stability	2.9
Slow Stability	1.0

Averaging

The Averaging setting allows the operator to select Automatic Smart averaging for faster measurement stability or Off for no measurement averaging once the stability criteria is met.

Alarms

The Limit Alarm allows the operator to set a high limit value and low limit value used to evaluate measurements. If a measurement goes above the high limit value or below the low limit value, the alarm is activated. For example, when the high limit is set to 8.500 pH and the low limit is set to 4.500 pH, the Limit Alarm is activated when a measurement of 8.501 pH or higher or a measurement of 4.499 pH or lower is observed in the measurement mode.

The Cal Due Alarm allows the operator to set a calibration interval in hours. If a calibration is not performed within the specified calibration interval, the alarm is activated.

The Set Point Alarm allows the operator to set a base value and offset value used to evaluate measurements. If the measurement goes above or below the base value by the entered offset value, the alarm is activated. For example, when the base value is set to 7.000 pH and the offset value is set to 2.000 pH, the Set Point Alarm is activated when a measurement of 9.000 pH or higher or a measurement of 5.000 pH or lower is observed in the measurement mode.

- Use the Buzzer – Alarm setting in the [Instrument Settings](#) setup menu to enable an audible beep whenever an alarm is activated.

pH and ISE Mode Settings

Buffer Group and Automatic Buffer Recognition

Versa Star Pro meters with pH, pH/ISE and pH/LogR modules are capable of automatically recognizing pH 1.68, 4.01, 7.00, 10.01 and 12.46 buffers; pH 1.68, 4.01, 6.86, and 9.18 buffers; or up to six custom buffers during a pH calibration, depending on the pH buffer set that is selected in the setup menu. During a calibration, the meter uses the selected buffer set and the raw mV reading of the pH electrode in the buffer to recognize and display the buffer value at the measured temperature. The raw mV reading of the pH electrode in the buffer must be within one pH unit (± 59 mV) of the buffer's theoretical mV value for the meter to recognize the buffer.

USA Buffer Set		DIN Buffer Set		Custom Buffer Set	
pH Buffer	mV range	pH Buffer	mV range	Entered pH Buffer Value	mV range (based on entered pH value)
1.68	+256 to +374 mV	1.68	+256 to +374 mV	1 st buffer value	Theoretical ± 59 mV
4.01	+119 to +236 mV	4.01	+119 to +236 mV	2 nd buffer value	Theoretical ± 59 mV
7.00	-59 to +59 mV	6.86	-51 to +67 mV	3 rd buffer value	Theoretical ± 59 mV
10.01	-236 to -119 mV	9.18	-70 to -188 mV	4 th buffer value	Theoretical ± 59 mV
12.46	-264 to -382 mV			5 th buffer value	Theoretical ± 59 mV
				6 th buffer value	Theoretical ± 59 mV

Testing a pH Electrode for Automatic Buffer Recognition

Use the following procedure to verify that the raw mV reading of the pH electrode is within one pH unit (± 59 mV) from the theoretical mV reading of the pH buffer, and therefore verify that the pH electrode in use is capable of performing automatic buffer recognition.

1. Prepare the pH electrode according to the electrode user manual. Set the meter measure mode to mV.
2. Rinse the pH electrode with distilled water, blot it dry with a lint-free tissue and place the pH electrode into a pH 4.01 buffer at approximately 25 °C.
3. Wait for the measurement to stabilize and record the mV value of the pH 4.01 buffer when the measurement is stable.
4. Remove the pH electrode from the pH 4.01 buffer.
5. Rinse the pH electrode with distilled water, blot it dry with a lint-free tissue and place the pH electrode into a pH 7.00 buffer at approximately 25 °C.
6. Wait for the measurement to stabilize and record the mV value of the pH 7.00 buffer when the measurement is stable.
7. The mV reading of the pH electrode in pH 4 buffer should be +119 to +236 mV and in pH 7 buffer should be -59 to +59 mV. If the mV readings are in the correct ranges, the pH electrode is capable of performing automatic buffer recognition. If the mV readings are not in the correct ranges, manually enter the pH buffer values during a pH calibration.

Isopotential Value

Versa Star Pro meters with pH, pH/ISE and pH/LogR modules offer the option for operators to enter an isopotential value for pH and ISE measurements. The slope of all electrodes changes with temperature, based on the Nernst equation. The slopes at the different temperatures intersect at the isopotential point, which is the point at which the electrode potential does not vary with temperature. For most pH electrodes, this point is 7.000. For ion selective electrodes (ISE), if the isopotential point is known or can be determined experimentally, entering this value makes temperature compensation for an ISE possible when a one or two point calibration is performed.

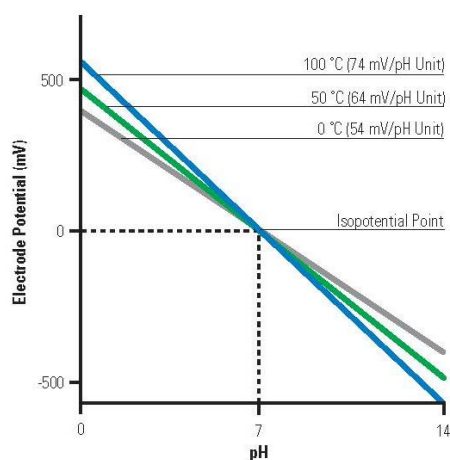

Determining an Isopotential Value for an Ion Selective Electrode

1. Prepare several standards with concentrations spanning the measuring range of the ion selective electrode.
2. Measure the mV value of the standards at room temperature, about 20 °C to 25 °C.
3. Measure the mV value of each standard at 75 °C.
4. Measure the mV value of each standard at 10 °C.
5. On semi-logarithmic graph paper, plot the concentration values on the log axis versus the mV values on the linear axis.
6. The lines will intersect at the isopotential value. Read the concentration from the graph for this point from the log axis, this is the isopotential value.

Linear Regression

Versa Star Pro meters with pH, pH/ISE and pH/LogR modules offer a linear regression feature for pH and ISE calibration curves. Linear regression determines how the slope will be implemented after a multi-point calibration is performed.

The default setting is linear regression off, which implements a traditional, segmented slope with point-to-point lines. The segmented approach is the most accurate and precise.

Using the linear regression off setting, straight-line segments are drawn between each successive pair of calibration points. Separate slope and E_0 values are calculated using the adjacent pair of calibration points. For example, in a five point calibration, four slopes and four E_0 values are calculated to correspond to the four line segments that connect the calibration points. pH or concentration values for samples are calculated according to the segment that their mV potential values fall into. Those above or below the range of calibration are calculated by extrapolation from the top or bottom most segment. The displayed slope is an average slope of the separate segments. The slope may be outside the range normally expected for an electrode. For example, if the slope of one segment is low, then the average will be lower than theoretical, even though the response may be Nernstian over most of the range.

Setting the linear regression on will implement a single best fit line for the calibration curve and can be beneficial if pH measurements vary greatly over a large range.

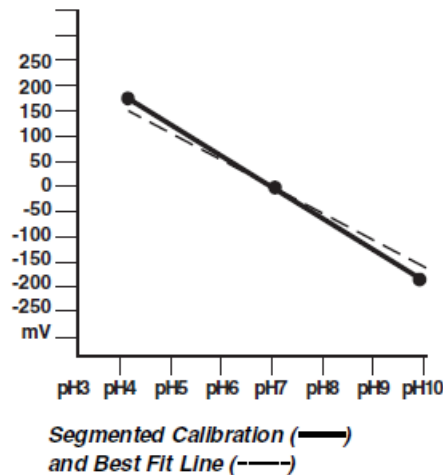

Blank Correction

Versa Star Pro meters with a pH/ISE module offer the option to use blank (non-linear) correction for ISE measurements when a multi-point calibration is performed. The automatic blank correction feature uses an algorithm to compensate for the non-linearity of an ion selective electrode in low level standards and samples.

With the blank correction feature enabled, the meter decides whether blank correction is the best measurement strategy by analyzing the electrode response during a multi-point calibration. A separate blank does not have to be run. Graphically, blank correction is equivalent to drawing a smooth curve through the lowest three points of the multi-point calibration and extrapolating to zero concentration based on the assumption of Nernstian electrode behavior.

Multi-point calibrations at the lower limit of detection are desirable when the response of an ion selective electrode is non-linear and cannot be characterized with a one or two point calibration. This is usually seen as a low electrode slope. Generally, the electrode is behaving in a Nernstian manner but the effect of a blank is being observed. See the figure below.

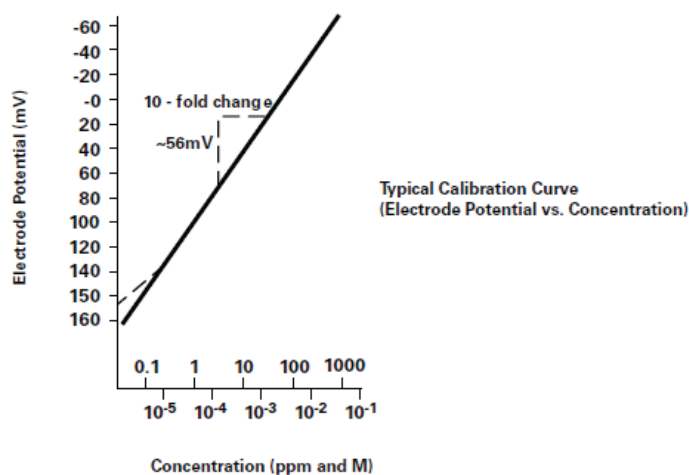

This blank may be a true reagent blank, traces of analyte ion in the reagents or it may be the “mud” value of the electrode. It could also be an interference in the reagents that becomes apparent at low levels of analyte ion, or it could be any combination of these effects. The expanded version of the Nernst equation traditionally used for blank correction is as follows:

$$E = E_0 + S \cdot \log (C + b) \quad \text{where } b \text{ is the blank}$$

In a multi-point calibration, a set of equations is generated and the relationship between them evaluated. For example, the equations generated in a three point calibration would be:

$$E_1 = E_0 + S \cdot \log (C_1 + b)$$

$$E_2 = E_0 + S \cdot \log (C_2 + b)$$

$$E_3 = E_0 + S \cdot \log (C_3 + b)$$

The meter evaluates the relationships between the three potentials E_1 , E_2 and E_3 and the three concentrations C_1 , C_2 and C_3 . If the relationships indicate that blank correction is desired, a blank will automatically be calculated and the non-linearity will be corrected for in a Nernstian manner. If the appropriate conditions are not met, the blank is set at zero and each segment of the multi-point calibration is treated independently.

When all three of the following conditions are met, blank correction is invoked.

1. The concentration of the first standard is zero, or the slope of the electrode between the first and second standards is less than the slope between the second and third.
2. Potential differences between points are significant. For example, $E_3 - E_1 > 10$ mV
3. The blank correction algorithm converges at reasonable blank and slope values.
Conditions in steps 1 and 2 prevent failure to converge in most situations. However, the slope will attain any value necessary for convergence to a calculated blank value of $3 \times C_3$.

When blank correction is implemented, the slope value for the electrode may be outside the range of values normally considered acceptable during an ordinary calibration. For best results, calibration standards should be close in range to the expected sample concentrations and should bracket the expected sample concentration. When conditions 1, 2 and 3 are not met, the calibration data is handled by the multi-point calibration method described earlier.

In calibrations with more than three points, a combination of methods is utilized. Automatic blank correction is used if the lowest three points satisfy the criteria and multi-point calibration is used for the other points. The slope calculated in the automatic blank correction algorithm and the slopes for each additional segment are used to calculate the average slope.

Low Level Stability

Versa Star Pro meters with a pH/ISE module offer the option to use the low level stability feature when calibrating ion selective electrodes. The low level stability feature improves the accuracy of low concentration ISE measurements by adjusting the timing for calibration points of low level standards, allowing a longer stabilization time for the electrode in the calibration standards. The stabilization time is typically extended to about three to five minutes per calibration point, but will vary based on the actual readings from the electrode during calibration.

LogR Temperature Technology

The Versa Star Pro meter with pH/LogR measurement module allows direct temperature measurement and temperature compensation using most standard glass-bulb pH electrodes and patented digital LogR technology.

LogR technology is based on using the electrical resistance of the pH-sensing glass-bulb as the temperature source. The logarithm of the resistance of the bulb varies almost linearly with the reciprocal of the absolute temperature. Almost all standard glass-bulb pH electrodes exhibit a similar decrease in resistance with increasing temperature. To maximize LogR performance and accuracy, a ROSS Ultra or ROSS pH electrode is recommended.

LogR Resistance vs. Temperature Graph

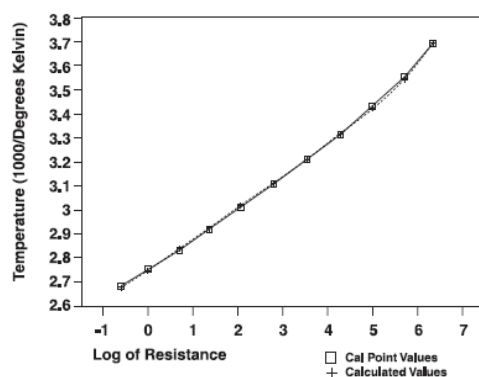

LogR Temperature Accuracy

Table 1 – Two Point LogR Temperature Calibration, Average Error at pH 3 and pH 11

Electrode	Average Temp. Error 0 to 25 °C (°C)	Average Temp. Error Above 20 °C * (°C)	Average Temperature Compensation Error 0 to 25 °C (pH Units)	Average Temperature Compensation Error Above 20 °C * (°C)
8202BN	0.36	0.10	0.004	0.001
8203BN	0.13	0.02	0.002	0.000
8235BN	0.04	0.14	0.000	0.002
8256BN	0.22	0.06	0.003	0.001
8272BN	0.23	0.06	0.003	0.001
9202BN	0.21	0.06	0.003	0.001
9203BN	0.20	0.10	0.002	0.001
9206BN	0.29	0.06	0.003	0.001
9207BN	0.16	0.07	0.002	0.001
9256BN	0.27	0.07	0.003	0.001
9272BN	0.22	0.06	0.003	0.001

* For 20 °C temperature compensation spans

Table 2 – Three Point LogR Temperature Calibration, Average Error at pH 3 and pH 11

Electrode	Average Temp. Error 0 to 25 °C (°C)	Average Temp. Error Above 20 °C *	Average Temperature Compensation Error 0 to 25 °C (pH Units)	Average Temperature Compensation Error Above 20 °C *
8202BN	0.04	0.03	0.000	0.000
8203BN	0.04	0.01	0.000	0.000
8235BN	0.07	0.06	0.001	0.001
8256BN	0.04	0.06	0.000	0.001
8272BN	0.02	0.01	0.000	0.000
9202BN	0.03	0.06	0.000	0.001
9203BN	0.06	0.05	0.001	0.001
9206BN	0.02	0.02	0.000	0.000
9207BN	0.07	0.07	0.001	0.001
9256BN	0.02	0.00	0.001	0.000
9272BN	0.22	0.06	0.003	0.001

* For 20 °C temperature compensation spans

Active Replacement Electrode for Electrodes Listed in Table 1 and Table 2

Obsolete Electrode	Available Replacement	Obsolete Electrode	Available Replacement
8202BN	8102BNUWP, 8102BN	9202BN	9102BNWP
8203BN	8103BNUWP, 8103BN	9203BN	9103BNWP
8235BN	8135BNUWP, 8135BN	9206BN	9106BNWP
8256BN	8156BNUWP, 815600	9256BN	9156BNWP
8272BN	8172BNWP	9272BN	9172BNWP

Advanced pH Electrode Diagnostics using LogR Technology

Electrode Troubleshooting Using LogR Technology

Many factors affect the performance of your pH combination electrode. While the majority of problems seen in electrode performance relate to reference issues, changes over time in the sensing glass can negatively affect performance. These effects can be monitored using a Versa Star Pro meter with pH/LogR measurement module. This can save time by helping to identify cases where cleaning and maintenance will not be able to rejuvenate the pH electrode.

Viewing Electrode Resistance

The pH electrode bulb resistance value can be viewed on the measurement screen when LogR is selected for the temperature source. For detailed information on selecting and calibrating LogR temperature, refer to the [LogR Temperature Calibration](#) section of this user manual.

Out-Of-The-Box Electrode Check

Follow this procedure to perform a quick evaluation of a new pH electrode and help diagnose a defective pH electrode.

1. Remove the pH electrode from the box.
2. Connect the pH electrode to the BNC input on the pH/LogR module connected with the Versa Star Pro meter.
3. If needed, select LogR as the temperature source:
 - a. In the measurement mode, press the **setup** key
 - b. Press the ◀ or ▶ key to highlight Channel # (the channel number the LogR module is connected with) and press the **f3 (Select)** key.
 - c. Press the ◀ or ▶ key to highlight Temperature and press the **f3 (Select)** key.
 - d. Press the ▲ or ▼ key to highlight Temperature Input and press the ◀ or ▶ key to highlight the channel number the LogR module is connected with (i.e. Ch2-LogR).
 - e. Press the measure (esc) key to return to the measurement mode.
4. Read the resistance value shown on the measurement display.
 - a. A resistance value of 0 indicates that the pH electrode may be defective.
 - b. A resistance value other than 0 indicates the pH electrode is responsive. Prepare the pH electrode according to the instructions in the electrode user manual. Perform the initial electrode check when the electrode is ready.

Initial Electrode Check

For the most pH electrode diagnostics benefits from the Versa Star Pro meter with pH/LogR measurement module, establish a regular schedule of resistance testing with the pH electrode. Perform an initial check of the pH electrode resistance and record the temperature and resistance value in the provided table, or perform a LogR temperature calibration and export the calibration information to a computer or printer.

1. Rinse the pH electrode with deionized water and blot dry with a lint-free tissue.
2. Insert the pH electrode into the solution and gently stir the solution.
3. Record the temperature and resistance value for reference.

The pH-sensing bulb thickness and diameter vary among pH electrodes, resulting in normal variations in resistance values. In most cases, the initial value is not a definitive test of electrode condition except in extreme cases such as the initial low readings information described below. When changing pH electrodes, do not be alarmed if the resistance varies dramatically from your previous electrode.

Initial Low Readings – If the resistance is below 1 MΩ in a solution at room temperature (22 to 27 °C), it indicates a damaged pH electrode. In this case, the electrode will most likely need to be replaced.

Periodic Electrode Testing

Periodically check the pH electrode resistance following the steps above and record resistance values in the provided table. Diagnostic testing at 25 °C is ideal, due to the resistance stability at this temperature. It is important to keep as many sampling variables constant as possible to get the most out of the periodic resistance testing. The resistance reading is fully dependent on temperature. When testing, use the same solution at a known, stable temperature each time and measure around the same temperature each time.

Small Variances in Resistance – Resistance will typically increase as the pH-sensing bulb ages. This is no cause for concern. Over time, this can lead to slower response rates, slope degradation and reduced immunity to noise. By keeping track of the change in resistance (delta, as listed in the table as an example), this information may be used to determine when to replace the pH electrode before failure occurs, eliminating down time.

Large Decreases in Resistance – When the pH-sensing glass membrane resistance is more than ten times lower than the expected resistance value at a given temperature, it is often an indication of a crack in the bulb or shorting of the electrode, leading to a total failure in function. If you see this type of change in the resistance reading, most likely no further testing or care will resolve the problem and a new pH electrode will be needed.

Increases in Resistance – As the electrode ages, the resistance of the glass pH-sensing bulb increases. Eventually, the aging of the electrode, and visible increase in resistance, manifests in a slower response rate, low slope, and reduced immunity to noise. At some point, the resistance becomes “super high”. The pH electrode diagnostics from the Versa Star Pro meter with pH/LogR measurement module help pinpoint causes of reduced pH electrode performance and quickly show the effectiveness of cleaning and care processes.

- If the resistance values are not out of expected range, but electrode response continues to be slow or erratic, these effects may also be seen because of reference clogging or contamination. Follow the cleaning procedures in the pH electrode user manual.
- If the resistance value between checks increases substantially higher, the fill solution may be depleted. Follow the cleaning and filling procedures in the pH electrode user manual.
- If the resistance values show a “super high” resistance, cleaning and care may improve performance, but will not be able to return the probe to like new condition. Consider purchasing a new electrode.

Conductivity, TDS, Salinity and Resistivity Mode Settings

Cell Constant (K) and Automatic Conductivity Calibration

Versa Star Pro meters with a conductivity module are capable of automatically recognizing Thermo Scientific Orion 100 $\mu\text{S}/\text{cm}$ conductivity standard, 1413 $\mu\text{S}/\text{cm}$ conductivity standard and 12.9 mS/cm conductivity standard when the nominal cell constant (K) value of the conductivity probe is entered in the setup menu.

Catalog Number	Description
011008	Orion 100 $\mu\text{S}/\text{cm}$ conductivity standard, 5 x 60 mL
011007	Orion 1413 $\mu\text{S}/\text{cm}$ conductivity standard, 5 x 60 mL
01100710	Orion 1413 $\mu\text{S}/\text{cm}$ conductivity standard, 10 individual use pouches
011006	Orion 12.9 mS/cm conductivity standard, 5 x 60 mL
01100610	Orion 12.9 mS/cm conductivity standard, 10 individual use pouches

The nominal cell constant (K) values for Thermo Scientific Orion conductivity probes compatible with Versa Star Pro meters with a conductivity module are listed below.

Catalog Number	Description	Measurement Range	Nominal Cell Constant
013005MD	Orion DuraProbe 4-cell conductivity probe with built-in temperature, 1.5 meter cable	1 $\mu\text{S}/\text{cm}$ to 200 mS/cm	$K = 0.475 \text{ cm}^{-1}$
013010MD	Orion DuraProbe 4-cell conductivity probe with built-in temperature, 3 meter cable	1 $\mu\text{S}/\text{cm}$ to 200 mS/cm	$K = 0.475 \text{ cm}^{-1}$
013020MD	Orion DuraProbe 4-cell conductivity probe with built-in temperature, 6 meter cable	1 $\mu\text{S}/\text{cm}$ to 200 mS/cm	$K = 0.475 \text{ cm}^{-1}$
013025MD	Orion DuraProbe 4-cell conductivity probe with built-in temperature, 10 meter cable	1 $\mu\text{S}/\text{cm}$ to 200 mS/cm	$K = 0.475 \text{ cm}^{-1}$
013605MD	Orion DuraProbe 4-cell conductivity probe with built-in temperature, 1.5 meter cable	10 $\mu\text{S}/\text{cm}$ to 200 mS/cm	$K = 0.55 \text{ cm}^{-1}$
013610MD	Orion DuraProbe 4-cell conductivity probe with built-in temperature, 3 meter cable	10 $\mu\text{S}/\text{cm}$ to 200 mS/cm	$K = 0.55 \text{ cm}^{-1}$
013016MD	Orion ultra-pure water 2-cell conductivity probe with built-in temperature, 1.5 meter cable	0.01 $\mu\text{S}/\text{cm}$ to 300 $\mu\text{S}/\text{cm}$	$K = 0.1 \text{ cm}^{-1}$
011510MD	Orion 2-cell conductivity probe with built-in temperature, 3 meter cable	10 $\mu\text{S}/\text{cm}$ to 200 mS/cm	$K = 1.0 \text{ cm}^{-1}$
011050MD	Orion 2-cell conductivity probe with built-in temperature, 1.5 meter cable	1 $\mu\text{S}/\text{cm}$ to 20 mS/cm	$K = 1.0 \text{ cm}^{-1}$
018020MD	Orion high range 2-cell conductivity probe, 1.5 meter cable	10 $\mu\text{S}/\text{cm}$ to 2000 mS/cm	$K = 10 \text{ cm}^{-1}$

Orion Conductivity Standard Values from 0 °C to 50 °C

Temperature (°C)	Orion 11.9mS/cm Conductivity Standard	Orion 12.9mS/cm Conductivity Standard	Orion 1413µS/cm Conductivity Standard	Orion 147µS/cm Conductivity Standard	Orion 100µS/cm Conductivity Standard
	Cat. No. 011005, 01100510 (mS/cm)	Cat. No. 011006, 01100610 (mS/cm)	Cat. No. 011007, 01100710 (µS/cm)	Cat. No. 01100910 (µS/cm)	Cat. No. 011008 (µS/cm)
0	65.10	7.135	776	81	54
1	66.84	7.344	799	83	56
2	68.59	7.555	822	86	58
3	70.35	7.768	846	88	59
4	72.12	7.983	870	91	61
5	73.91	8.200	894	93	63
6	75.70	8.418	918	96	64
7	77.50	8.638	943	98	66
8	79.32	8.860	968	101	68
9	81.15	9.084	992	103	70
10	82.98	9.309	1017	106	72
11	84.83	9.535	1043	108	73
12	86.69	9.763	1068	111	75
13	88.56	9.993	1094	114	77
14	90.45	10.22	1119	116	79
15	92.34	10.46	1145	119	81
16	94.24	10.69	1171	122	83
17	96.15	10.93	1198	125	85
18	98.08	11.16	1224	127	87
19	100.0	11.40	1251	130	88
20	102.0	11.64	1277	133	90
21	103.9	11.88	1304	136	92
22	105.9	12.12	1331	138	94
23	107.9	12.36	1358	141	96
24	109.9	12.61	1386	144	98
25	111.9	12.85	1413	147	100

Temperature (°C)	Orion 111.9mS/cm Conductivity Standard Cat. No. 011005, 01100510 (mS/cm)	Orion 12.9mS/cm Conductivity Standard Cat. No. 011006, 01100610 (mS/cm)	Orion 1413µS/cm Conductivity Standard Cat. No. 011007, 01100710 (µS/cm)	Orion 147µS/cm Conductivity Standard Cat. No. 01100910 (µS/cm)	Orion 100µS/cm Conductivity Standard Cat. No. 011008 (µS/cm)
26	113.9	13.10	1441	150	102
27	115.9	13.35	1468	153	104
28	117.9	13.59	1496	156	106
29	120.0	13.84	1524	159	108
30	122.0	14.09	1552	161	110
31	124.1	14.34	1580	164	112
32	126.2	14.59	1608	167	114
33	128.3	14.85	1636	170	117
34	130.4	15.10	1665	173	119
35	132.5	15.35	1693	176	121
36	134.6	15.61	1722	179	123
37	136.7	15.86	1751	182	125
38	138.9	16.12	1780	185	127
39	141.0	16.37	1808	188	129
40	143.2	16.63	1837	191	131
41	145.4	16.89	1866	194	134
42	147.6	17.15	1896	197	136
43	149.8	17.40	1925	200	138
44	152.0	17.66	1954	203	140
45	154.2	17.92	1983	206	142
46	156.4	18.18	2013	209	145
47	158.7	18.44	2042	212	147
48	160.9	18.70	2071	215	149
49	163.2	18.96	2101	219	151
50	165.4	19.22	2130	222	154

Reference Temperature, Temperature Compensation and Temperature Coefficient

Versa Star Pro meters with a conductivity module offer several options for temperature compensated conductivity measurements. Temperature has a large effect on the conductivity value of a solution. The temperature compensation feature allows the meter to use the sample conductivity and temperature readings to calculate and display the conductivity that the sample would be expected to have at a selected reference temperature, such as 25 °C. To accurately use the temperature compensation feature, select the proper type of temperature compensation for the samples to be measured; set the required reference temperature as 5 °C, 10 °C, 15 °C, 20 °C or 25 °C; and use a conductivity probe with built-in ATC temperature probe.

The options for temperature compensation are:

- Linear – uses the temperature coefficient value to apply a constant percent correction factor to every degree change in temperature. A few common linear coefficient values are:

Solution (25 °C to 50 °C)	Temperature Coefficient (% / °C)
Sugar Syrup	5.64
Ultra Pure Water	4.55
98 % Sulfuric Acid	2.84
Salt (NaCl)	2.12
Dilute Ammonia	1.88
5 % NaOH	1.72
10 % HCl	1.32
5 % Sulfuric Acid	0.96

- nLFn (non-linear ultra-pure non-degassed water) – applies a non-constant correction factor to pure water samples that have a varying response to changes in temperature. This mode is for temperature compensated readings of low conductivity waters that are in equilibrium with the carbon dioxide in air, such as pure waters reading near 1 $\mu\text{S}/\text{cm}$ at 25 °C and natural waters having a composition comparable to natural ground, well or surface waters.
- nLFu (non-linear ultra-pure degassed water) – applies a non-constant correction factor to pure water samples that have a varying response to changes in temperature. This mode is for temperature compensated readings of ultra-pure water that contains no air and no carbon dioxide, such as ultra-pure water (18 megohms resistance or higher) directly from the source without aeration.
- EP – no temperature correction is applied (temperature compensation turned off) and a warning is displayed if the measured conductivity value is over the EP requirement for pure water at the measured sample temperature.
- Off - no temperature correction is applied and the actual conductivity value is displayed at the measured sample temperature.

Cell Type

The Versa Star Pro meter with conductivity module accepts 2-cell and 4-cell conductivity probes and allows the type of conductivity probe to be set as Standard (most conductivity probes) or USP (for the ultra-pure water conductivity probe, Catalog Number 013016MD, when disabling temperature compensation).

TDS Factor

The Versa Star Pro meter with conductivity module measures TDS as the total amount of dissolved inorganic material in a solution. The dissolved inorganic material carries a current that is measured by the conductivity probe. Since there is a direct relationship between conductivity and TDS, conductivity readings are used to estimate the presence of inorganic material using the TDS factor entered in the setup menu.

The standard method of determining TDS involves evaporating a sample to dryness at 180 °C and weighing the residue. The TDS factor is calculated by taking the residue weight and dividing it by the sample conductivity. Subsequent conductivity readings are multiplied by the TDS factor to determine the TDS value of the sample.

Salinity Type

The Versa Star Pro meter with conductivity module offers two salinity types: practical salinity and natural sea water. Practical salinity measurements are based on relating the sample measurement to the reading of a standard potassium chloride (KCl) solution at 15 °C. The Versa Star Pro meter with conductivity module will automatically temperature compensate and report the expected practical salinity result as practical salinity units (psu) at 15 °C when using a conductivity probe with built-in temperature sensor. Natural sea water measurements use a historic convention known as UNESCO 1966 and the Versa Star Pro meter with conductivity module will report the expected natural sea water result as parts per thousand (ppt).

Dissolved Oxygen Settings

Barometric Pressure Compensation

The Versa Star Pro meter with RDO/DO module has an internal barometer that can be used for automatic pressure compensated dissolved oxygen readings. Manual barometric pressure compensation can also be used if dissolved oxygen is measured with a submerged probe or in a pressurized vessel. The pressure must be entered as mm Hg.

1 mm Hg = 0.03937 inch Hg = 1.3332 hPa (mBar) = 0.01934 PSI

Salinity Correction

Automatic salinity correction for dissolved oxygen readings reported as mg/L is available on the Versa Star Pro meter with RDO/DO module when a conductivity module and conductivity probe are used simultaneously. The meter uses the conductivity value read by the conductivity probe to calculate the salinity correction factor and applies the factor to dissolved oxygen readings reported as mg/L. Manual salinity correction can be used for dissolved oxygen readings reported as mg/L on all Versa Star Pro meters with RDO/DO module. The manual salinity correction factor must be entered as ppt (parts per thousand).

Conductivity at 20 °C (mS/cm)	Salinity Correction Value (ppt)	Conductivity at 20 °C (mS/cm)	Salinity Correction Value (ppt)	Conductivity at 20 °C (mS/cm)	Salinity Correction Value (ppt)
5	3	20	13	35	25
6	4	21	14	36	25
7	4	22	15	37	26
8	5	23	15	38	27
9	6	24	16	39	28
10	6	25	17	40	29
11	7	26	18	42	30
12	8	27	18	44	32
13	8	28	19	46	33
14	9	29	20	48	35
15	10	30	21	50	37
16	10	31	22	52	38
17	11	32	22	54	40
18	12	33	23	56	42
19	13	34	24		

Calculated from the International Oceanographic Tables, Vol. 1, National Institute of Oceanography of Great Britain, Womley, Godaming, Surrey, England and Unesco, Paris 1971.

Water and Lab Products

Australia: (613) 9757-4300 In Australia: (1300) 735-295 **China:** (86) 21-6865-4588
Germany: (49) 6184-90-6321 **India:** (91) 22-6716-2261/2247 **Japan:** (81) 045-453-9175
North America: 1-978-232-6000 Toll Free: 1-800-225-1480 **Singapore:** (65) 6778-6876

Find out more at thermofisher.com/water

For Research Use Only. Not for use in diagnostic procedures. © 2017 Thermo Fisher Scientific Inc. All rights reserved. RDO is a registered trademark of In-Situ Inc. Microsoft, Windows and Microsoft Vista are registered trademarks of Microsoft Corporation. All other trademarks are the property of Thermo Fisher Scientific Inc. & its subsidiaries unless otherwise specified.