

**Thermo Scientific  
Laboratory  
Temperature  
Control Products**

Manual Part Number U01152  
Rev. 03/03/2020

**ADVANCED Series Heated  
Immersion Circulators**

AC150      AC200

**ARCTIC Series  
Refrigerated/Heated  
Bath Circulators**

A10            A25            A45HC

A10B          A25B

**SAHARA Series Heated  
Bath Circulators**

S7            S13            S21

S45           S49

S14P          S21P



**Multilingual Quick  
Start Guides**

**Multilingual Essential  
Safety Instructions**

**Installation**

**Operation**

**Preventive  
Maintenance**

**Troubleshooting**

Visit our Web site at:

<http://www.thermofisher.com/tc>  
Product Service Information, Applications  
Notes, SDS Forms, e-mail.

Voice Info: (800) 258-0830



**Thermo Scientific  
Laboratory  
Temperature  
Control Products**

Manual Part Number U01152  
Rev. 03/03/2020

**ADVANCED Series Heated  
Immersion Circulators**

AC150 AC200

**ARCTIC Series  
Refrigerated/Heated  
Bath Circulators**

A10 A25 A45HC

A10B A25B

**SAHARA Series Heated  
Bath Circulators**

S7 S13 S21

S45 S49

S14P S21P



**Multilingual Quick  
Start Guides**

**Multilingual Essential  
Safety Instructions**

**Installation**

**Operation**

**Preventive  
Maintenance**

**Troubleshooting**

Visit our Web site at:

<http://www.thermofisher.com/tc>  
Product Service Information, Applications  
Notes, SDS Forms, e-mail.

Voice Info: (800) 258-0830

## **Thermo Fisher Scientific**

25 Nimble Hill Road  
Newington, NH 03801  
Tel : (800) 258-0830 or  
(603) 436-9444  
Fax : (603) 436-8411  
[www.thermoscientific.com/tc](http://www.thermoscientific.com/tc)

## **Sales, Service, and Customer Support**

25 Nimble Hill Road  
Newington, NH 03801  
Tel: (800) 258-0830  
Sales: 8:00 am to 5:00 pm  
Service and Support: 8:00 am to 6:00 pm Monday  
through Friday (Eastern Time)  
Fax: (603) 436-8411  
[service.tc.us@thermofisher.com](mailto:service.tc.us@thermofisher.com)

Dieselstrasse 4  
D-76227 Karlsruhe, Germany  
Tel : +49 (0) 721 4094 444  
Fax : +49 (0) 721 4094 300  
[info.tc.de@thermofisher.com](mailto:info.tc.de@thermofisher.com)

Building 6, No. 27  
Xin Jinqiao Rd., Shanghai 201206  
Tel : +86(21) 68654588  
Fax : +86(21) 64457830  
[info.china@thermofisher.com](mailto:info.china@thermofisher.com)

### **Statement of Copyright**

Copyright © 2021 Thermo Fisher Scientific. All rights reserved.

This manual is copyrighted by Thermo Fisher Scientific.

Users are forbidden to reproduce, republish, redistribute, or resell any materials from this manual in either machine-readable form or any other form.

# Table of Contents

## Quick Starts

<b>Preface</b>	<b>i</b>
Compliance	i
WEEE	i
Feedback	i
Unpacking	i
After-Sale Support	ii
<b>Section 1 Safety</b>	<b>1-1</b>
Safety Warnings	1-1
Personal Protective Equipment	1-3
Training	1-3
<b>Section 2 General Information</b>	<b>2-1</b>
Description	2-1
Immersion Circulator Specifications	2-1
Bath/Circulator Specifications	2-3
Wetted Materials	2-8
<b>Section 3 Installation</b>	<b>3-1</b>
Ambient Conditions	3-1
Immersion Circulator Only	3-1
Bath Circulator	3-2
Grounding Strap and Nut	3-2
Ventilation	3-3
Electrical Requirements	3-3
External Circulation	3-7
Remote Temperature Sensor	3-8
Multifunction Port (AC 200 only)	3-8
USB Port (AC 200 only)	3-8
Tubing Requirements	3-8
Tubing	3-9
Approved Fluids	3-10
Additional Fluid Precautions	3-12
Filling Requirements	3-13
Draining	3-13
<b>Section 4 Operation</b>	<b>4-1</b>
ADVANCED Immersion Circulators	4-1
Setup	4-2
Start Up	4-2

	Status Display .....	4-3
	Stand By Mode.....	4-3
	Stopping the Circulator.....	4-4
	Power Down.....	4-4
	Shut Down.....	4-4
	Restarting .....	4-4
	Changing the Setpoint.....	4-5
	Menu Displays.....	4-6
	Menu .....	4-6
	Menu Tree.....	4-7
	Settings .....	4-8
	System.....	4-13
	High Temperature Cutout .....	4-22
<b>Section 5</b>	<b>Accessories .....</b>	<b>5-1</b>
	Optional Lifting Platform Installation.....	5-1
	Optional Immersion Cooler Bridge Installation.....	5-2
	Optional Rack Assembly Instructions.....	5-3
	Optional Serial Communication Adapter.....	5-4
	Multifunction Port Standard I/O DB-15HD .....	5-5
	Tubing.....	5-6
<b>Section 6</b>	<b>Preventive Maintenance.....</b>	<b>6-1</b>
	Cleaning .....	6-1
	Condenser Fins .....	6-1
	Ground Strap and Nut.....	6-2
	Testing the Safety Features .....	6-2
<b>Section 7</b>	<b>Troubleshooting.....</b>	<b>7-1</b>
	Error Displays .....	7-1
	Checklist .....	7-5
<b>Appendix</b>	<b>Serial Communications.....</b>	<b>A-1</b>
<b>Warranty</b>		

**⚠️ 1. This quick start guide is intended for initial start up only. For all other procedures you must refer to the manual. Also, if any of these steps are not clear refer the manual before proceeding.**

**Safety:**

- The bath is designed for indoor use only. Never place the bath in a location where excessive heat, moisture, inadequate ventilation, or corrosive materials are present.
- Leave refrigerated baths in an upright position at -25°C for 24 hours before starting.
- Connect the bath to a properly grounded outlet.
- For Sahara baths, and stand-alone circulators, secure the grounding strap to the top of the metal tank.
- Never operate the equipment with a damaged line cord.
- The refrigerants are heavier than air and will replace the oxygen causing loss of consciousness. Contact with leaking refrigerant will cause skin burns. Refer to the bath's nameplate and the manufacturer's most current MSDS for handling precautions and disposal.
- Move the bath with care, sudden jolts or drops can damage its components. Always turn the equipment off and disconnect it from its supply voltage before moving it.
- Never operate damaged or leaking equipment.

**What you need to get started:**

- An adjustable wrench
- Appropriate hose or plumbing
- Appropriate size hose clamps
- Flat head screwdriver

**Table 1. Approved Fluids:**

Water is the only approved fluid for transparent acrylic bath and polyethylene oxide baths.  
All others: Filtered/single distilled water (pH 7-8)

Deionized water (1-3 MΩ-cm, compensated)  
Distilled water with Nalco biocide and inhibitor  
Distilled water with chlorine (5 ppm)  
0 to 75% Laboratory Grade Glycol/Water





SIL 100	SIL 300	SYNTH 60
SIL 180		SYNTH 260

- When using water above 80°C monitor the fluid level, frequent top-offs will be required. It also creates steam.
- Water/glycol mixtures require top-offs with pure water, otherwise the percentage of glycol will increase resulting in high viscosity and poor performance.

- Ensure none of the tubing comes in contact with the power cord.
- Extreme operating temperatures will lead to extreme temperatures on the tube surface, this is even more critical with metal nozzles.
- Ensure the tubing you select meets your maximum temperature and pressure requirements.
- Do not subject tubing to mechanical strain and ensure any specified bend radius is not exceeded.
- Always turn off the circulator and disconnect the power cord from the power source before installing the optional platform or bridge.
- Limit all acrylic bath's maximum high temperature setting to the temperature indicated on the label on the front of the bath, 80 °C.
- Use only the approved fluids shown in Table 1. Before using any fluid where contact with the fluid is likely, refer to the manufacturer's MSDS for handling precautions and disposal. Also, refer to the MSDS for venting requirements.
- Avoid overflowing, oil-based fluids expand when heated.

Ensure the HTC is in the full clockwise position. 

For all refrigerated baths, place its circuit protector located on the rear of the bath to the **I** position.

3. Press , the Start Display appears. Ensure the start symbol  is highlighted, if not use the arrow keys to navigate to the symbol. Press . The circulator starts and the start symbol turns into a stop symbol . The pump starts immediately but the compressor takes 30 seconds.

The circuit protection is designed to protect the circulator. The circulator's line cord is designed to act as a disconnecting device, position the circulator so it is not difficult to access the cord.

Refer to the bath nameplate on the rear of the bath for specific electrical requirements. Voltage deviations of ± 10% are permissible. The outlet must be rated as suitable for total power consumption.

- Ensure the cords do not come in contact with any of the plumbing connections or tubing.

**1A. For refrigerated baths** make all supplied communication and electrical connections prior to starting.

- Never connect controller power inlet, **B**, to a power outlet. Never connect power outlet, **C**, to anything but the circulator.



Install the supplied communications cable, **A**, between the circulator and the bath RJ45 connectors.

Install the power cord from the connector, **B**, to the connector on the bath, **C**. Connect the bath's power cord, **D**, to a grounded power outlet, **E**.

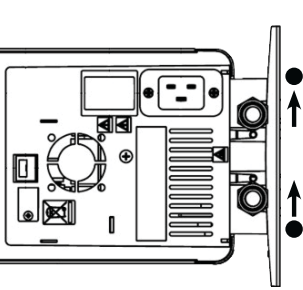
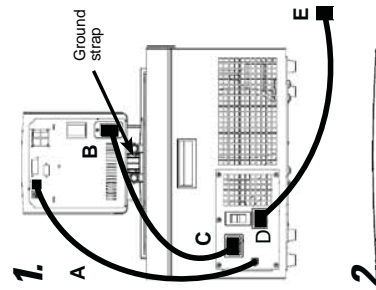
**1B. For non-refrigerated baths** the power supply, **B**, goes directly to a grounded power outlet, **E**.



2. Plumbing connections for external circulation are on the rear of the circulator.

 is the return flow from the external application.  is the outlet flow to the external application. The connections are 16 mm O.D.

If desired, remove the union nuts and plates to install the supplied 8 or 12 mm hose barsbs and clamps.

- To prevent damage to the circulator's plumbing, use a 19 mm backing wrench when removing/installing the external connections.

Ensure the drain port is closed and that all plumbing connections are secure.

To avoid spilling, place any application containers into the bath before filling. Fill the bath work area from 2.0 cm (3/4") to 5.0 cm (2") below the top.

**3**

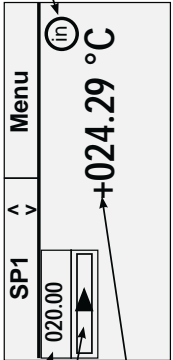

Start Display

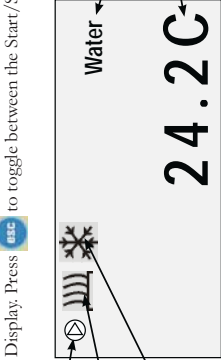

- Setpoint
- Highlighted Start Symbol
- Reservoir Fluid Temperature
- Indicates the controller is displaying the internal temperature probe value.

**4**



Status Display

- Pump Running Symbol
- Heater Running Symbol
- Refrigeration Running Symbol
- Selected Reservoir Fluid
- Reservoir Fluid Temperature

4. If desired, press  to bring up the Status Display. Press  to toggle between the Start/Status Displays.

After starting check all plumbing connections for leaks. Adjust the High Temperature Cutout (HTC) safety device, refer to the manual.

**A** Diese Kurzanleitung ist nur für die erste Inbetriebnahme vorgesehen. Für alle anderen Verfahren müssen Sie im Handbuch nachsehen. Auch wenn irgendwelche Schritte unverstandlich sind, laden Sie das Handbuch herunter, bevor Sie fortfahren.

- Sicherheit:**
- Das Bad darf nur in geschlossenen Rumen betrieben werden. Stellen Sie das Bad niemals an Orten auf, an denen es ubermaiger Hitze, Feuchtigkeit, unzureichender Belufung oder korrosiven Stoffen ausgesetzt ist.
  - Schlieen Sie das Bad an eine ordnungsgema geerdete Steckdose an.
  - Fur Sahara Bader, und eigenstandige Umwalpumpen, sichern Sie das Masseband auf der Oberseite des Tanks aus Metall.
  - Betreiben Sie das Gerat niemals mit einem beschadigten Stromkabel.
  - Da die verwendeten Kuhlmittel schwerer als Luft sind und den Sauerstoff verdrangen, kann es zu Bewusstlosigkeit kommen. Der Kontakt mit auslaufendem Kuhlmittel kann Hautverbrennungen verursachen. Informationen zu Vorsichtsmanahmen fur Umgang und Entsorgung finden Sie auf dem Typenschild des Bads sowie im aktuellen Sicherheitsdatenblatt (SDB) des Herstellers.
  - Bewegen Sie das Bad vorsichtig; plotzliche Erschutterungen oder Sturze konnen die Bauteile beschadigen. Schalten Sie das Gerat immer ab und trennen Sie es von der Versorgungsspannung, bevor Sie es bewegen.
  - Betreiben Sie niemals beschadigte oder undichte Ausrustung.

**Sie benotigen fur die Inbetriebnahme:**

- Einen verstellbaren Schraubenschlüssel
- Passende Schlauche bzw. Leitungen
- Schlauchklemmen in geeigneter Groe

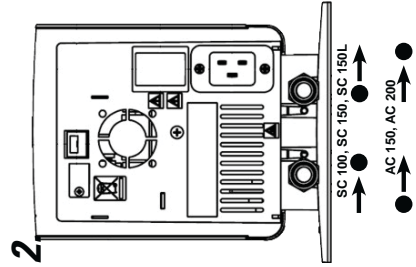
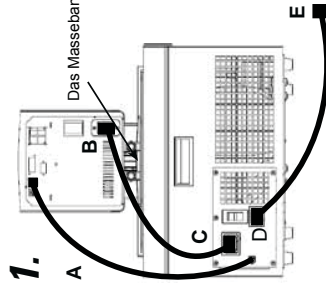

**Tabelle 1. Genehmigte Flussigkeiten:**

Alle Thermostate:  
 Filtriertes/einfach destilliertes Wasser (pH 7 bis 8)  
 Deionisiertes Wasser (1 bis 3 MΩ-cm, kompensiert)  
 Destilliertes Wasser mit Nalco Biozid und Inhibitor  
 Destilliertes Wasser mit Chlor (5 ppm)  
 Glykol-/Wasser-Gemische von 0 bis 75 % in Laborqualitat

Nur SC 150, SC 150L, AC 150 und AC 200:  
 SIL 100  
 SIL 300  
 SYNTH 60  
 SYNTH 260

• Wenn Sie Wasser mit einer Temperatur von uber 80 °C verwenden, ubewachen Sie den Fullstand, da ein haufiges Auffullen erforderlich sein wird. Auerdem kommt es zur Dampfbildung.

• Wasser/Glykol-Gemische mussen mit reinem Wasser nachgefullt werden, da ansonsten der Glykolananteil ansteigt, was eine hohe Viskositat und eine schlechte Leistung zur Folge hat.

- Kuhlbader mussen vor Inbetriebnahme 24 Stunden bei ca. 25 °C aufrecht stehen. Stellen Sie das Gerat in die Stellung im Uhrzeigersinn bis zum Anschlag.
- Starten Sie das Thermostat erst, nachdem Sie die Badflussigkeit dem Behalter hinzugegeben haben. Halten Sie zusatzliche Flussigkeit griffbereit.

Stellen Sie bei Kuhlbadern den Stromkreisschutz an der Ruckseite des Bads auf die Position I. Stellen Sie bei allen Thermostaten den Stromkreisschutz an der Ruckseite auf die Position I. Die blaue LED auf dem vorderen Bedienfeld beginnt zu leuchten.

- 3. Drucken Sie auf **Start-Symbol** und die Startanzeige wird angezeigt. Stellen Sie sicher, dass das Start-Symbol hervorgehoben ist. Sollte dem nicht so sein, verwenden Sie die Pfeiltasten, um zu dem Symbol zu navigieren.

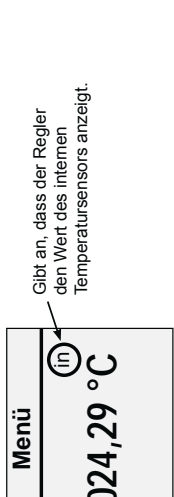

Drucken Sie auf **Start-Symbol** Das Thermostat wird gestartet, und das Start-Symbol verwandelt sich in das Stopp-Symbol Die Pumpe wird sofort gestartet; der Kompressor erst nach 30 Sekunden.

- 4. Drucken Sie ggf. auf **Symbol: Kuhlung in Betrieb** um die Statusanzeige einzublenden. Drucken Sie auf **Symbol: Pumpe in Betrieb** und **Symbol: Heizung in Betrieb** um zwischen der Start- und der Statusanzeige umzuschalten.

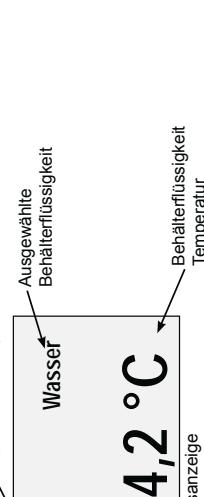

Uberprufen Sie nach dem Starten alle Wasseranschlusse auf undichte Stellen. Stellen Sie den Ubertemperaturschutz (HTC) ein; siehe Handbuch. Drucken und halten Sie **Symbol: Kuhlung in Betrieb** fur funf Sekunden lang, um in das Sprachwahlnenu zu gelangen.

Der Stromkreisschutz ist fur den Schutz des Thermostats ausgelegt. Das Stromkabel des Thermostats ist als Trennvorrichtung vorgesehen; positionieren Sie das Thermostat so, dass das Kabel gut zuganglich ist.

Die spezifischen elektrischen Anforderungen finden Sie auf dem Bad-Typenschild an der Ruckseite des Bads. Es sind Spannungsschwankungen von ±10 % zulassig. Die Steckdose muss als geeignet fur den Gesamtenergieverbrauch eingestuft sein.

- Achten Sie darauf, dass die Kabel nicht mit einem der Wasseranschlusse oder den Schlauchen in Kontakt geraten.
- 1A. Bei Kuhlbadern mussen alle vorgesehenen Kommunikations- und Stromverbindungen vor dem Start hergestellt werden.
- Der Stromeingang des Reglers (B) darf niemals an einen Stromausgang angeschlossen werden. Schlieen Sie den Stromausgang (C) ausschlielich an den Thermostat an. Schlieen Sie das mitgelieferte Kommunikationskabel (A) an den RJ45-Anschlussen des Thermostats und des Bads an.
- Schlieen Sie das Stromkabel vom Anschluss (B) an den Anschluss des Bads (C) an.
- Schlieen Sie das Stromkabel des Bads (D) an eine geerdete Steckdose (E) an.
- 1B. Bei nicht gekuhlten Badern verlauft die Stromversorgung (B) direkt zu einer geerdeten Steckdose (E).

2. Die Wasseranschlusse fur die externe Umwalzung befinden sich an der Ruckseite des Thermostats.

ist der Ruckfluss von der externen Anwendung. ist der Zufluss zur externen Anwendung. Der Auendurchmesser der Anschlusse betragt 16 mm. Entfernen Sie bei Bedarf die Uberwurfmutter und Platten, um die mitgelieferten 8 mm- bzw. 12 mm-Schlauchhullten und -klemmen zu montieren.

- Um Beschadigungen der Thermostatschlusse zu vermeiden, verwenden Sie beim Entfernen/Installieren der externen Anschlusse einen 19 mm-Gabelschlüssel. Verschlieen Sie bei SC100/ SC150/SC150L-Thermostaten die Pumpentuse mit dem mitgelieferten Anschlusstuck, um den maximalen Druck fur die externe Anwendung nicht zu uberschreiten.

Achten Sie darauf, dass der Ablaufhahn an der Vorderseite des Bads geschlossen ist und alle Wasseranschlusse fest sitzen.

Um ein Uberlaufen zu vermeiden, stellen Sie alle Anwendungsbehalter vor dem Befullen in das Bad.

Befullen Sie das Bad so, dass ein Arbeitsbereich von 2,0 cm bis 4,0 cm von der Oberkante erhalten bleibt.

- Vermeiden Sie ein Uberfullen, da Flussigkeiten auf Obasis sich unter Erwarmung ausdehnen.



**⚠ Sécurité :** Ce guide de démarrage rapide est destiné à la mise en marche initiale uniquement. Pour toute autre procédure, merci de vous référer au manuel. De plus, si l'une de ses étapes ne vous paraît pas claire, télécharger le manuel avant de commencer.

**Sécurité :**

- Les baignoires ont été conçus pour fonctionner exclusivement à l'intérieur. Ne jamais exposer le bain à une chaleur ou une humidité excessive, à une ventilation inadéquate ou à des matières corrosives.
- Brancher le bain à une prise correctement reliée à la terre.
- Pour Sahara bains, et circulateurs autonome, fixez la sangle de mise à la terre vers le haut de la cuve métallique.
- Ne jamais faire fonctionner un appareil dont le cordon d'alimentation est endommagé.
- Les réfrigérants sont plus lourds que l'air et peuvent remplacer l'oxygène, provoquant ainsi une perte de connaissance. Tout contact avec des réfrigérants qui fuient peut provoquer des brûlures cutanées. Pour plus d'informations concernant les précautions d'utilisation et de mise au rebut, se reporter à la plaque signalétique du bain et à la Fiche de données de sécurité (MSDS) du fabricant la plus récente.
- Déplacer le bain avec soin, les secousses soudaines et les chutes pouvant endommager ses composants. À chaque déplacement de l'équipement, toujours le mettre hors tension et le débrancher de son alimentation.

**Matériel nécessaire pour commencer :**

- Clé à molette
- Tuyau et accessoires de plomberie appropriés
- Colliers de serrage de dimension appropriée

**Tableau 1. Liquides approuvés :**

Tous les circulateurs :

- Eau filtrée/mono-distillée (pH 7-8)
- Eau désionisée (1 à 3 MQ-cm, compensée)
- Eau distillée avec biocide Nalco et ses inhibiteurs
- Eau distillée avec chlore (5 ppm)
- Glycol de qualité laboratoire/ eau 0 à 75 %

SC 150, SC 150 L, AC 150 et AC 200 uniquement :

- SIL 100
- SIL 300
- SIL 180

SYNTH 60

SYNTH 260

- Lorsque la température de l'eau est supérieure à 80°C, surveiller le niveau des liquides. Il devra être régulièrement complété. De la vapeur d'eau est également générée.
- Les mélanges d'eau et de glycol doivent être réajustés et complétés par de l'eau pure. Si tel n'est pas le cas, le pourcentage de glycol augmente, ce qui accroît la viscosité du mélange et diminue ses performances.

**Matériel nécessaire pour commencer :**

- Clé à molette
- Tuyau et accessoires de plomberie appropriés
- Colliers de serrage de dimension appropriée

**Tableau 1. Liquides approuvés :**

Tous les circulateurs :

- Eau filtrée/mono-distillée (pH 7-8)
- Eau désionisée (1 à 3 MQ-cm, compensée)
- Eau distillée avec biocide Nalco et ses inhibiteurs
- Eau distillée avec chlore (5 ppm)
- Glycol de qualité laboratoire/ eau 0 à 75 %

SC 150, SC 150 L, AC 150 et AC 200 uniquement :

- SIL 100
- SIL 300
- SIL 180

SYNTH 60

SYNTH 260

- Lorsque la température de l'eau est supérieure à 80°C, surveiller le niveau des liquides. Il devra être régulièrement complété. De la vapeur d'eau est également générée.
- Les mélanges d'eau et de glycol doivent être réajustés et complétés par de l'eau pure. Si tel n'est pas le cas, le pourcentage de glycol augmente, ce qui accroît la viscosité du mélange et diminue ses performances.

**1.** Le dispositif de protection du circuit est conçu pour protéger le circulateur. Le cordon d'alimentation du circulateur est conçu pour servir de dispositif de déconnexion. Placer ainsi le circulateur de sorte à pouvoir accéder facilement au cordon.

La plaque signalétique située à l'arrière du bain indique les caractéristiques électriques spécifiques. Les écarts de tension admissibles sont de ±10 %. La prise doit prendre en charge la puissance totale de l'appareil.

- S'assurer que les câbles n'entrent pas en contact avec les raccords des tuyaux ou la tuyauterie.

**1A. Bains réfrigérés :** effectuer tous les raccords électriques et de communication avant le démarrage du système.

- Ne jamais raccorder la prise d'alimentation du contrôleur (B) à une prise de courant. Toujours, et uniquement, raccorder la prise de courant (C) à un circulateur.

Installer le câble de communication fourni (A) entre le circulateur et les connecteurs RJ45 du bain.

Raccorder le cordon d'alimentation du connecteur (B) au connecteur du bain (C). Brancher le cordon d'alimentation du bain (D) sur une prise de courant avec mise à la terre (E).

**1B. Bains non réfrigérés :** l'alimentation électrique (B) doit être reliée directement à une prise de courant avec mise à la terre (E).

**2.** Les raccords du circuit externe se trouvent à l'arrière du circulateur.

- correspond au flux de retour de l'application externe.
- correspond au flux de sortie vers l'application externe. Les raccords ont un diamètre extérieur de 16 mm.

Au besoin, retirer les écrous-raccords et les plaques afin d'installer les raccords cannelés et les colliers de serrage de 8 mm ou 12 mm fournis.

- Afin d'éviter d'endommager la tuyauterie du circulateur, utiliser une clé de maintien de 19 mm pour retirer/installer les connexions externes.

Sur le couvercle des circulateurs STANDARD, la base de la pompe et les accessoires fournis garantissent une pression maximale vers l'application externe.

S'assurer que l'orifice de vidange, situé à l'avant du bain est fermé et que tous les raccords de tuyauterie sont sécurisés (verrouillés et étanches).

Pour éviter les délaboussures, placer les contenants de l'application dans le bain avant de remplir ce dernier.

Remplir la zone de travail du bain entre 2,0 et 4,0 cm en dessous du bord supérieur.

- Éviter de trop remplir le bain, les liquides à base d'huile augmentant de volume avec la chaleur.

**3.** Appuyer sur **ESC** pour afficher l'écran de démarrage.

Vérifier que le symbole de démarrage **▶** est en surbrillance. Si tel n'est pas le cas, le sélectionner à l'aide des touches fléchées.

**3.** Appuyer sur **ESC** pour afficher l'écran de démarrage.

Vérifier que le symbole de démarrage **▶** est en surbrillance. Si tel n'est pas le cas, le sélectionner à l'aide des touches fléchées.

**4.** Appuyer sur **ESC** pour appeler l'écran d'état.

Appuyer sur **ESC** pour basculer entre l'écran de démarrage et l'écran d'état.

**4.** Appuyer sur **ESC** pour appeler l'écran d'état.

Appuyer sur **ESC** pour basculer entre l'écran de démarrage et l'écran d'état.

**5.** Appuyer sur **ESC** pour appeler l'écran de démarrage.

Appuyer sur **ESC** pour basculer entre l'écran de démarrage et l'écran d'état.

**5.** Appuyer sur **ESC** pour appeler l'écran de démarrage.

Appuyer sur **ESC** pour basculer entre l'écran de démarrage et l'écran d'état.

**6.** Appuyer sur **ESC** pour appeler l'écran de démarrage.

Appuyer sur **ESC** pour basculer entre l'écran de démarrage et l'écran d'état.

**6.** Appuyer sur **ESC** pour appeler l'écran de démarrage.

Appuyer sur **ESC** pour basculer entre l'écran de démarrage et l'écran d'état.

**7.** Appuyer sur **ESC** pour appeler l'écran de démarrage.

Appuyer sur **ESC** pour basculer entre l'écran de démarrage et l'écran d'état.

**7.** Appuyer sur **ESC** pour appeler l'écran de démarrage.

Appuyer sur **ESC** pour basculer entre l'écran de démarrage et l'écran d'état.

**8.** Appuyer sur **ESC** pour appeler l'écran de démarrage.

Appuyer sur **ESC** pour basculer entre l'écran de démarrage et l'écran d'état.

**8.** Appuyer sur **ESC** pour appeler l'écran de démarrage.

Appuyer sur **ESC** pour basculer entre l'écran de démarrage et l'écran d'état.

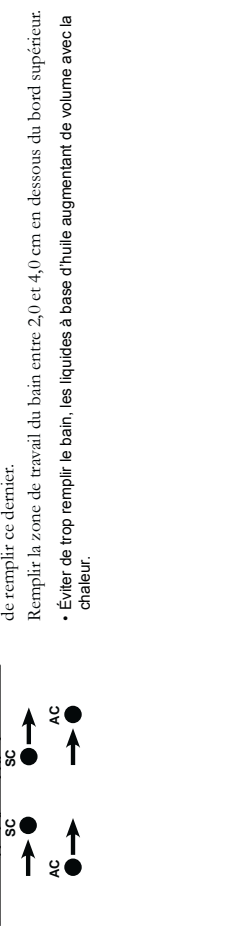
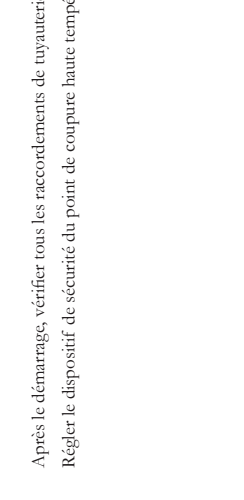
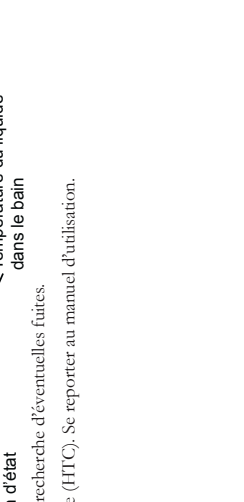
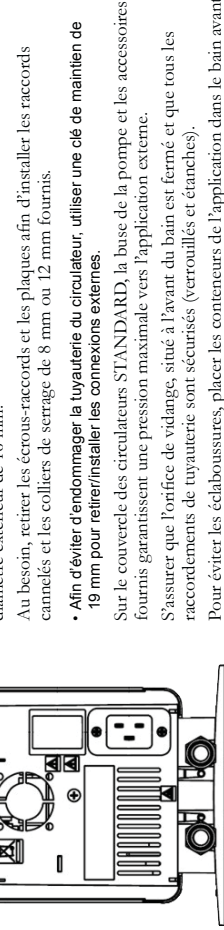
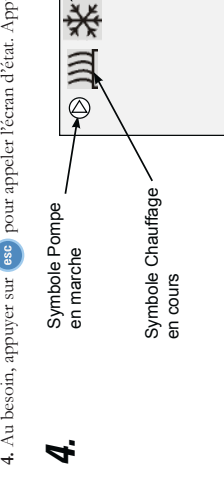
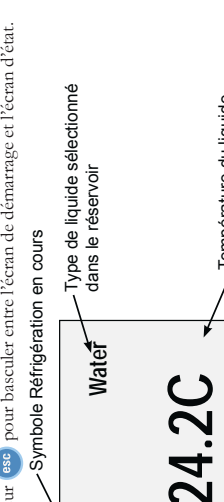
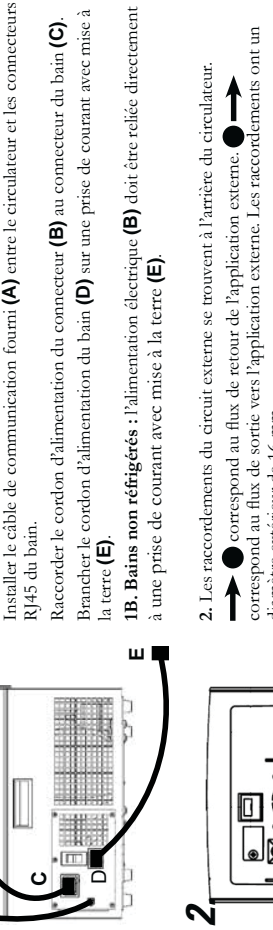
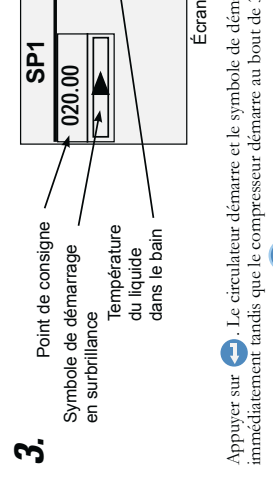
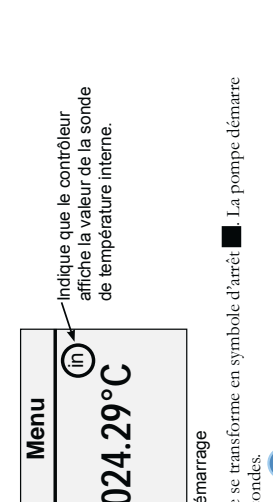
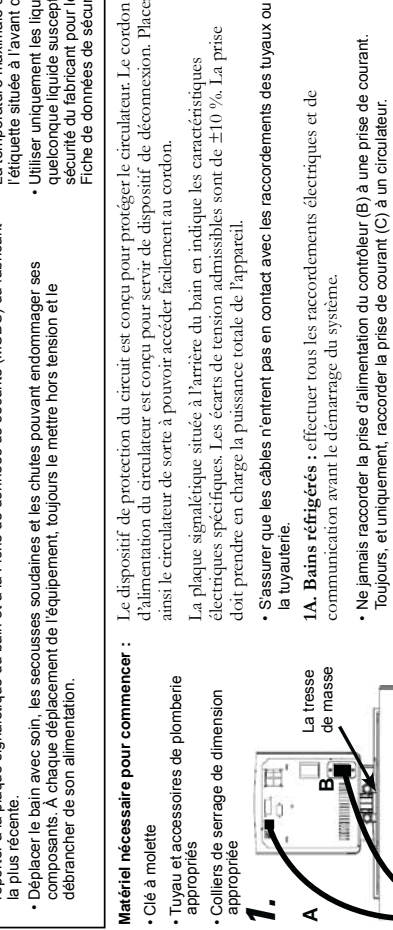
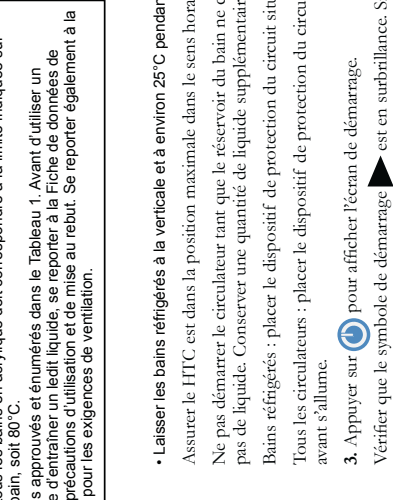
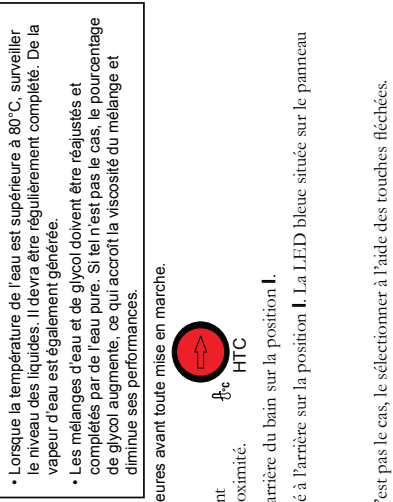
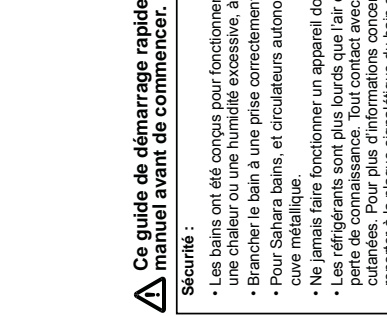
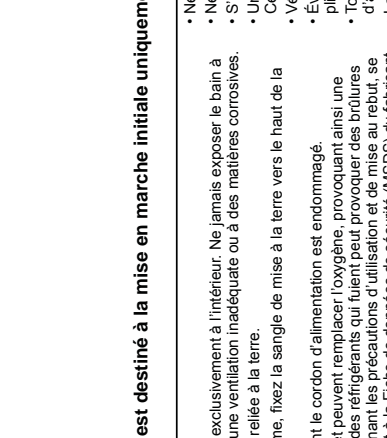
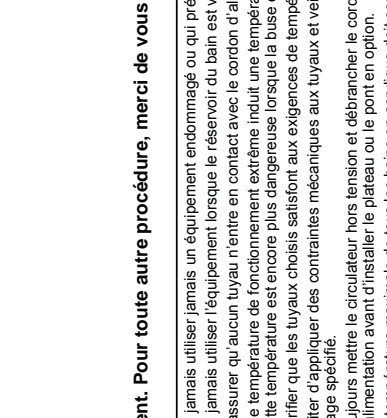

**⚠ Esta guía de puesta en marcha rápida se ha elaborado únicamente para el arranque inicial. Para obtener información sobre otros procedimientos, debe consultar el manual. Asimismo, en caso de que tuviera dudas sobre alguno de estos pasos, descargue el manual antes de continuar.**

**Seguridad:**

- El baño está destinado exclusivamente para uso en interiores. No lo coloque nunca en lugares con calor o humedad excesivos o ventilación inadecuada, ni en presencia de materiales corrosivos.
- Conecte el baño a una toma de tierra adecuada.
- Para el Sáhara, baños independientes y circuladores, fijar la tira de tierra a la parte superior del depósito de metal.
- En caso de que el cable de alimentación esté dañado, no utilice el equipo.
- Los refrigerantes son más pesados que el aire, por lo que sustituirán al oxígeno y provocarán la pérdida del conocimiento. En caso de que entre en contacto con el refrigerante procedente de fugas, se producirán quemaduras en la piel. Consulte la placa identificativa del baño y la hoja de datos de seguridad de materiales (MSDS) más actual del fabricante para obtener información sobre la eliminación y las precauciones de manipulación.
- Mueva el baño con cuidado, ya que las caídas o los saltos repentinos pueden dañar los componentes. Apague siempre el equipo y desconéctelo de la tensión eléctrica antes de moverlo.
- Nunca ponga en funcionamiento un equipo que esté dañado o que presente fugas.

**Tabla 1. Líquidos aprobados:**

Todos los circuladores:  
 Agua filtrada/destilada (pH 7 - 8)  
 Agua desionizada (1-3 MΩ-cm, compensada)  
 Agua destilada con inhibidor y biocida Nalco  
 Agua destilada con cloro (5 ppm)  
 Agua/glicol para laboratorio al 0 - 75 %

SC 150, SC 150L, AC 150 y AC 200 únicamente:  
 SIL 100 SIL 300 SYNTH 60  
 SIL 180 YNTH 260

- Al utilizar agua por encima de 60 °C para monitorizar el nivel de líquido, será necesario rellenar el líquido con frecuencia. Además, también se origina vapor.
- En las mezclas de agua/glicol, es necesario rellenar con agua pura; de lo contrario, aumentará el porcentaje de glicol y se producirá un aumento de la viscosidad y una disminución del rendimiento.

**Materiales necesarios:**

- Una llave inglesa ajustable
- Manguera o elementos de fontanería apropiados
- Abrazaderas de manguera de tamaño adecuado

La protección del circuito está diseñada para proteger el circulador. El cable de alimentación del circulador está diseñado para actuar como dispositivo de desconexión; coloque el circulador de forma que permita acceder al cable con facilidad.

Consulte los requisitos eléctricos concretos que aparecen en la placa con el nombre del baño, situada en la parte trasera. Se permite una desviación de tensión de ± 10 %.

La toma de corriente debe admitir el consumo de energía total.

- **Asegúrese de que los cables no entren en contacto con los tubos ni con las conexiones de fontanería.**

**1A. Para baños refrigerados:** establezca todas las conexiones eléctricas y de comunicación suministradas antes de comenzar.



• Nunca conecte la entrada de alimentación del controlador, **B**, a una toma de corriente. **Nunca conecte la toma de alimentación, C, a ningún otro aparato que no sea un circulador.**

Instale el cable de comunicaciones suministrado, **A**, entre el circulador y los conectores RJ45 del baño.

Instale el cable de alimentación del conector, **B**, al conector del baño, **C**. Conecte el cable de alimentación del baño, **D**, a una toma de corriente con derivación a tierra, **E**.

**1B. Para baños no refrigerados:** la fuente de alimentación, **B**, se conecta directamente a una toma de corriente con derivación a tierra, **E**.

**2.** Las conexiones de fontanería para la circulación externa se encuentran en la parte trasera del circulador.

-  representa el flujo de retorno procedente de la aplicación externa.
-  representa el flujo de salida hacia la aplicación externa. Las conexiones tienen un diámetro externo de 16 mm.

Si lo desea, retire las placas y tuercas para instalar las abrazaderas y conexiones dentadas de 8 o 12 mm que se suministran.

- **Para evitar que se produzcan daños en la fontanería del circulador, utilice una llave inglesa fija de 19 mm para retirar o instalar las conexiones externas.**

En circuladores SC100, SC150, SC150L, tape la boquilla de la bomba con el accesorio suministrado para obtener la máxima presión en la aplicación externa.

Asegúrese de que el orificio de deságote, situado en la parte delantera del baño, esté cerrado y de que todas las conexiones de fontanería estén bien apretadas.

Para evitar salpicaduras, introduzca los recipientes de la aplicación en el baño antes de llenarlo.

Llene el área de trabajo del baño dejando entre 2,0 cm (0,79 pulg.) y 4,0 cm (1,57 pulg.) por debajo del tope.

- **No llene el baño en exceso; los líquidos a base de aceite se expanden con el calor.**

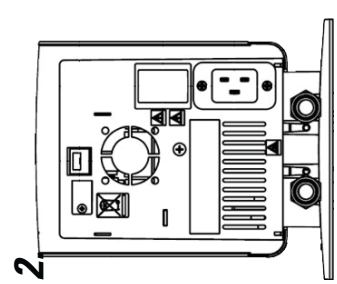
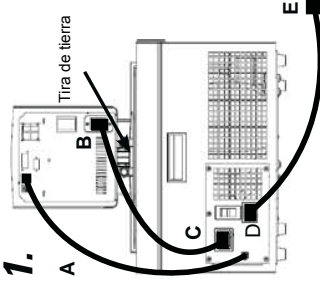

• Los baños refrigerados deben mantenerse durante 24 horas en posición vertical y a unos 25 °C antes de su puesta en marcha.

Asegurar el HTC está en la posición totalmente a la derecha.

No ponga en marcha el circulador hasta que haya añadido el líquido al depósito de baño. Tenga a mano líquido adicional.



En los baños refrigerados, coloque el protector de circuito, situado en la parte trasera, en la posición de encendido, **I**.

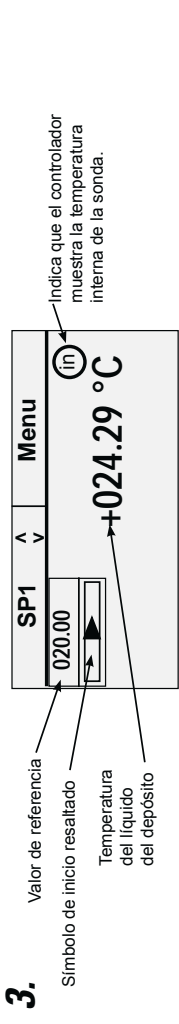

Para todos los circuladores, coloque el protector de circuito, situado en la parte trasera, en la posición de encendido **I**. El indicador LED azul del panel frontal se iluminará.

3. Pulse  y aparecerá la pantalla de inicio.

Asegúrese de que el símbolo de inicio  aparece resaltado; en caso contrario, utilice las teclas de flecha para desplazarse hasta el símbolo.



**3.** Pulse . El circulador arrancará y el símbolo de inicio se convertirá en un símbolo de parada . La bomba se inicia automáticamente, pero el compresor tarda 30 segundos.

4. Si lo desea, pulse  para que aparezca la pantalla de estado. Pulse  para alternar entre las pantallas de inicio y estado.

**4.** Símbolo de funcionamiento de la bomba

Símbolo de funcionamiento del calentador

Temperatura del depósito

Líquido del depósito seleccionado

Temperatura del depósito

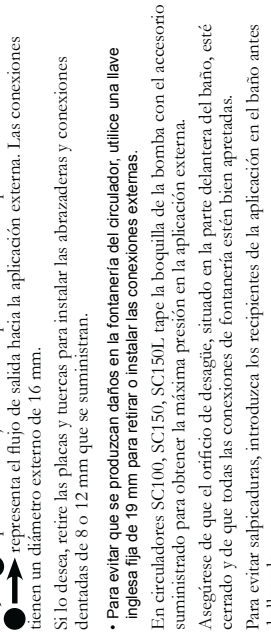

Una vez puesta en marcha la unidad, revise todas las conexiones de fontanería para detectar posibles fugas. Ajuste el corte de temperatura alta (HTC) del dispositivo de seguridad; consulte el manual.

**La presente guida rapida è destinata a fornire indicazioni riguardanti esclusivamente la messa in servizio. Per qualsiasi altra procedura fare riferimento al manuale. Qualora in questa guida rapida siano presenti passaggi poco chiari, scaricare il manuale prima di procedere.**

**Sicurezza:**

- Il bagno è destinato esclusivamente all'utilizzo in ambienti chiusi. Non posizionare mai il bagno in un luogo eccessivamente caldo o nel quale siano presenti umidità, ventilazione inadeguata o materiali corrosivi.
- Collegare il bagno ad una presa dotata di messa a terra.
- Per bagni del Sahara, e stand-alone di circolatori, fissare la fascetta di messa a terra per la parte superiore del serbatoio di metallo.
- Non azionare mai l'apparecchio in presenza di un cavo di alimentazione danneggiato.
- I refrigeranti sono più pesanti dell'aria e sostituiscono l'ossigeno causando perdita di coscienza. Il contatto con eventuali perdite di refrigerante può causare ustioni cutanee. Fare riferimento alla targhetta e all'ultima scheda di sicurezza sui materiali (MSDS) fornita dal produttore per le indicazioni su gestione e smaltimento.
- Spostare il bagno con cautela: sobbalzi improvvisi o cadute possono danneggiare i componenti. Spegnerne sempre l'apparecchio e scollegarlo dalla tensione di alimentazione prima di spostarlo.
- Non azionare mai apparecchi danneggiati o che presentino perdite.

La protezione di circuito serve a proteggere il circolatore. Il cavo di alimentazione del circolatore è progettato per funzionare quale dispositivo di interruzione; posizionare il circolatore in modo tale che il cavo possa essere raggiunto con facilità.

Fare riferimento alla targhetta del bagno posta sul retro del bagno stesso per i requisiti elettrici. Sono ammesse deviazioni di tensione di  $\pm 10\%$ . La presa deve essere ritenuta idonea per il consumo di energia totale.

• Assicurarsi che i cavi non entrino in contatto con i collegamenti dei tubi o con i tubi stessi.

**1A. Per i bagni refrigerati** eseguire tutti i collegamenti elettrici e di comunicazione prescritti prima di iniziare.

• Non collegare mai la presa di ingresso dell'alimentazione elettrica del controller, **B**, ad una presa di corrente. Non collegare mai la presa di allacciamento, **C**, a elementi diversi dal circolatore.

Installare il cavo di comunicazione fornito, **A**, tra il circolatore e i connettori RJ45 del bagno.

Installare il cavo di alimentazione del connettore, **B**, al connettore posto sul bagno, **C**.

Collegare il cavo di alimentazione del bagno, **D**, a una presa di corrente dotata di messa a terra, **E**.

**1B. Per i bagni non refrigerati** il cavo di alimentazione, **B**, deve essere collegato direttamente a una presa di corrente dotata di messa a terra, **E**.

2. I collegamenti dei tubi per la circolazione esterna si trovano sul lato posteriore del circolatore.

→ indica il flusso di ritorno dall'applicazione esterna. ● → indica il flusso di uscita verso l'applicazione esterna. I connettori hanno un diametro esterno di 16 mm.

Se lo si desidera, rimuovere i dadi e le piastre di raccordo e installare le fascette e i raccordi da 8 o da 12 mm forniti.

• Onde evitare danni alle tubature del circolatore, usare una controchiave da 19 mm per la rimozione/installazione dei collegamenti esterni.

Sui circolatori SC 100, SC 150 SC150L, chiudere l'ugello della pompa con l'accessorio fornito per ottenere la massima pressione verso l'applicazione esterna.

Assicurarsi che la portella di scarico posta sul lato anteriore del bagno sia chiusa e che tutti i collegamenti dei tubi siano fissati.

Onde evitare riversamenti, posizionare tutti i contenitori nel bagno prima di procedere al riempimento.

Riemplire l'area di lavoro del bagno fino a 2,0 cm (3/4") — 4,0 cm (1 1/2") al di sotto dell'orlo.

• Non riempire eccessivamente; i liquidi a base oleosa si espandono quando riscaldati.

**Elementi necessari per iniziare:**

- Una chiave inglese
- Tubature adeguate
- Fascette per tubi di dimensioni adeguate

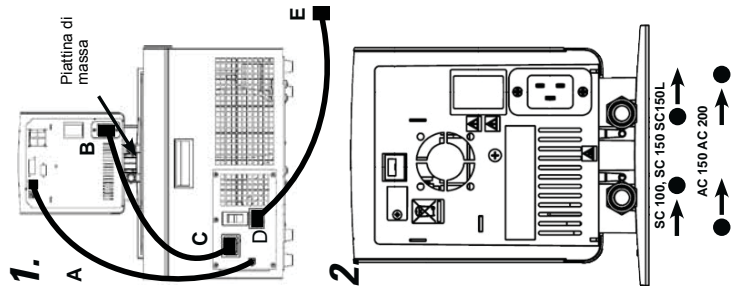

- Non azionare mai l'apparecchio senza aver inserito il liquido nel serbatoio del bagno.
- Assicurarsi che nessun tubo entri in contatto con il cavo di alimentazione.
- Temperature di esercizio estreme determinano temperature estreme sulla superficie dei tubi. Questo aspetto riveste un'importanza maggiore con gli ugelli in metallo.
- Assicurarsi che i tubi scelti soddisfino i requisiti massimi di temperatura e pressione.
- Non sottoporre i tubi a deformazione meccanica e assicurarsi che non venga superato il raggio di piegatura specificato.
- Spegnerne sempre il circolatore e scollegare il cavo di alimentazione dalla fonte di alimentazione prima di installare la piattaforma o il ponte opzionale.
- Impostare la temperatura indicata sull'etichetta posta sul lato frontale del bagno (80 °C) quale limite per le impostazioni della temperatura massima di tutte le parti in materiale acrilico dell'apparecchio.
- Usare esclusivamente i liquidi approvati elencati nella Tabella 1. Prima di usare qualsiasi liquido con il quale è probabile che si verifichi un contatto, fare riferimento all'MSDS fornita dal produttore per le indicazioni su gestione e smaltimento. Fare riferimento all'MSDS anche per i requisiti di aerazione.

**Tabella 1. Liquidi approvati:**

Per tutti i circolatori:

- Acqua filtrata/a singola distillazione (pH 7-8)
- Acqua deionizzata (1-3.MΩ-cm, compensata)
- Acqua distillata con biocida e inibitore Nalco
- Acqua distillata con cloro (5 ppm)
- Soluzione di glicole e acqua a grado di laboratorio da 0 a 75%

Solo per SC 150, SC 150L, AC 150 e AC 200:

- SIL 100
- SIL 300
- SYNTH 60
- SYNTH 260

- Monitorare il livello del liquido quando si utilizza acqua oltre gli 80 °C; potrebbero essere necessari rabbocchi frequenti. Viene inoltre generato vapore.
- Le miscele di acqua/glicole richiedono rabbocchi con acqua pura; in caso contrario, la percentuale di glicole aumenta determinando un incremento della viscosità a discapito del rendimento.

• Lasciare i bagni refrigerati in posizione verticale ad una temperatura di ~25 °C per 24 ore prima dell'avvio.

Garantire l'HTC è nella posizione di fine corsa in senso orario. Non azionare il circolatore prima di aver aggiunto il liquido nel serbatoio del bagno. Tenere del liquido di riserva a portata di mano.

Per i bagni refrigerati, portare il protettore di circuito posto sul lato posteriore dell'apparecchio in posizione I.

Per tutti i circolatori, portare il protettore di circuito posto sul lato posteriore in posizione I. Il LED blu sul pannello frontale si illumina.

3. Premere **ESC**; viene visualizzato il Display avvio.

Assicurarsi che il simbolo di avvio **▶** sia evidenziato; in caso contrario usare i tasti di direzione per spostarsi sul simbolo.

**3.**

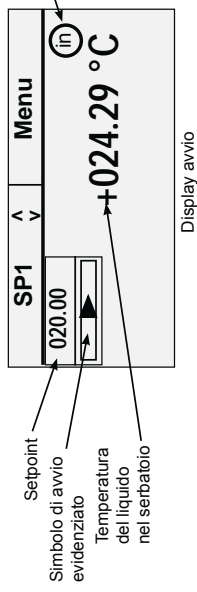

Premere **ESC**. Il circolatore si avvia e il simbolo di avvio si trasforma in un simbolo di interruzione **■**. La pompa si avvia immediatamente, mentre per il compressore sono necessari 30 secondi.

4. Se lo si desidera, premere **ESC** per visualizzare il Display stato. Premere **ESC** per alternare il Display avvio/stato.

**4.**

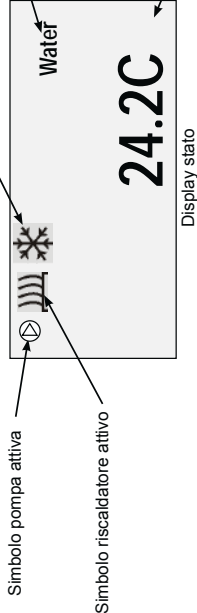

Dopo l'avvio, controllare tutti i collegamenti dei tubi per escludere eventuali perdite.

Regolare il dispositivo di sicurezza HTC (High Temperature Cutout); fare riferimento al manuale.



## STANDARD/ADVANCED snelstartgids

### Veiligheidsmaatregelen:

- De unit is alleen ontworpen voor gebruik binnenshuis.
- Plaats een unit nooit op een plek met overmatige warmte, vocht, onvoldoende ventilatie of corrosieve materialen.
- Gebruik nooit ontvlambare of corrosieve vloeistoffen met deze unit.
- Verzeker u ervan dat u een slang kiest die voldoet aan de vereisten voor wat betreft maximumtemperatuur en druk.
- Raadvleeg voordat u vloeistoffen gebruikt of onderhoud uitvoert op plekken waar waarschijnlijk contact is met vloeistof, de veiligheidsbladen van de fabrikant voor voorzorgsmaatregelen.

Voor Sahara baden en stand-alone circulatie/thermostaten, bevestig de massakabel aan de bovenkant van het metalen reservoir.

## 1 Elektrische/communicatie-aansluitingen

De unit is bestemd voor gebruik op een speciale uitlaat. Alle circulatiepompen zijn uitgerust met automatische thermisch getriggerde 20 Amp circuitbeveiliging.

De circuitbeveiliging is ontworpen om de circulatiepomp te beschermen, en is niet bedoeld ter vervanging van de beveiliging van afkaccircuits. Het is de verantwoordelijkheid van de gebruiker om te zorgen voor een stroomonderbreker. Stel de circulatiepomp zo op, dat het niet moeilijk is om de stroomonderbreker te bedienen.

Raadvleeg het naamplaatje van het bad op de achterste, bovenste linkerhoek van het bad voor de specifieke elektrische vereisten. Spanningsvariaties van  $\pm 10\%$  zijn toegestaan. Het nominale vermogen van het stopcontact moet geschikt zijn voor het totale stroomverbruik van de unit.

**Voor koelbaden:**  
ervoor zorgen dat alle communicatieverbindingen en elektrische aansluitingen tot stand zijn gebracht alvorens de unit te starten.

- De meegeleverde R/45 afgeschermde kabel tussen de thermostaat kop en de R/45 connectors van het bad installeren (als Ethernet). **Dit is nodig om een goede werking te verzekeren.**
- Bevestig de stroomkabel van de connector op de achterkant van de thermostaat kop, A, met de connector op de achterkant van het koelbad, B.
- Verbind de stroomkabel van het bad, C, met een geaard stopcontact.

**Voor koelbaden nooit de stroomingang van de controller, A, met een stopcontact verbinden. De stroomuitgang, B, nooit met iets anders dan met een thermostaat kop verbinden.**  
Ervoor zorgen dat de elektriciteitsnoeren niet in aanraking komen met de leidingaansluitingen of de slangen.

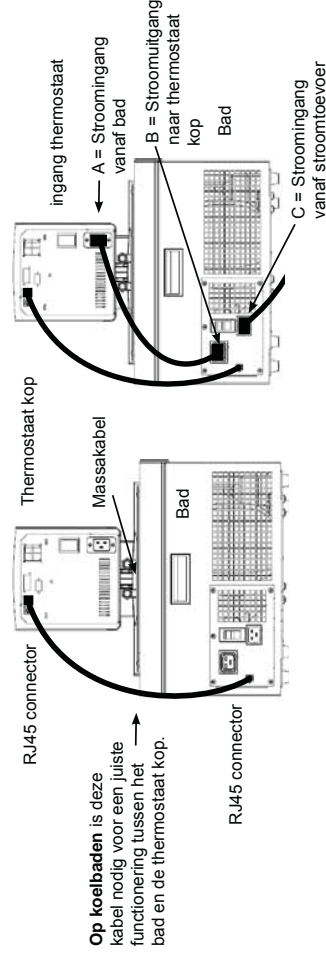

## 2 Aansluitingen en externe doorstroming

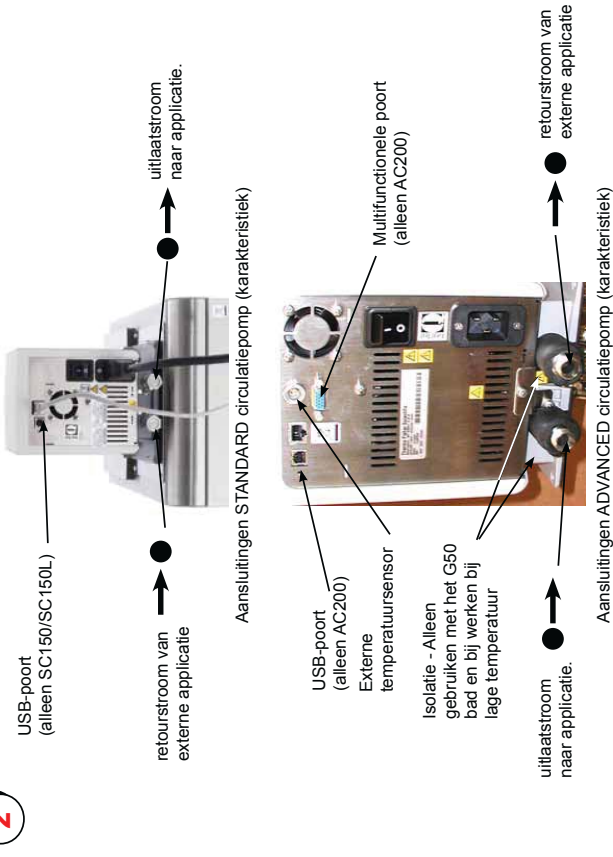

De slang wordt normaal gebruikt om de pomp te verbinden met een externe applicatie.

De leidingaansluitingen voor externe circulatie zitten op de achterkant van de circulatiepomp. Verwijder de moeren en afschermingen om bij de unit geleverde slangadapters en klemmen van de 8 mm of 12 mm slang te installeren.

**Om beschadigingen aan de slangadapters en de moeren tijdens het bevestigen of verwijderen te voorkomen, gebruik een steeksleutel nummer 19.**

**OPMERKING** Op STANDARD circulatiepompen de spuitmond van de pomp afsluiten met de bijgeleverde fitting voor maximumdruk naar de externe applicatie, zie de handleiding.

U ervan verzekeren dat het ventiel van de uitlaat van het reservoir op de voorkant van de unit *gesloten* is en dat alle leidingaansluitingen stevig vastzitten.

Om morsen te voorkomen, de vloeistofhouders van uw applicatie in het bad plaatsen voordat u gaat vullen.

Vul de opening van het bad van 2,0 cm (3/4") tot 5,0 cm (2") onder de bovenkant, zie de volgende pagina voor geschikte vloeistof.

**Niet teveel vullen, vloeistoffen op oliebasis zetten uit wanneer ze verwarmd worden.**

Wanneer er naar een extern systeem gepompt wordt, extra vloeistof bij de hand houden om het juiste peil in de circulatieleidingen en het externe systeem te handhaven. Bij het verwarmen van de vloeistof, het vloeistofpeil bewaken.

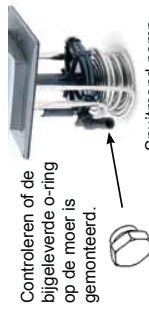

## Opstarten

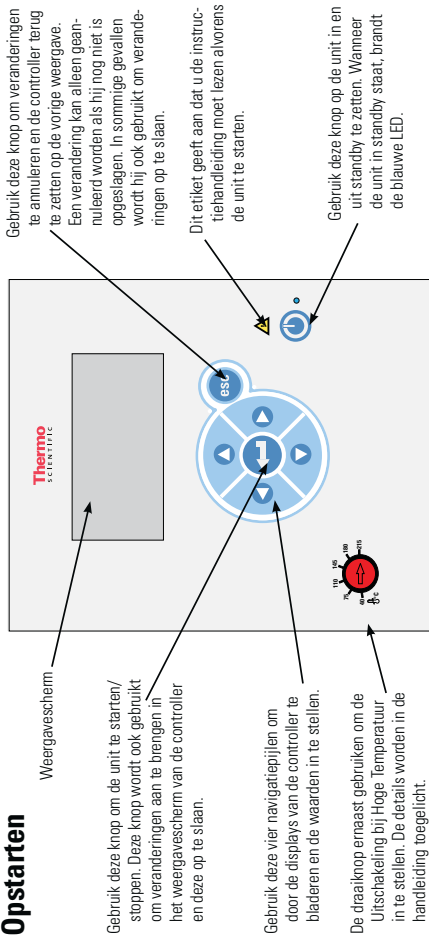

**U moet koelunits 24 uur lang rechtop bij kamertemperatuur (-25 °C) laten staan alvorens ze op te starten. Op die manier kan de smeeroelie teruglopen in de compressor.**



**Alvorens de unit te starten, een grondige test van alle USB-aansluitingen (optioneel), elektrische aansluitingen en leidingaansluitingen doen.**



Zorg ervoor dat de HTC is gedraaid.

De unit niet laten werken voordat hij met vloeistof is gevuld. Extra vloeistof bij de hand houden. Als de unit niet start, de handleiding raadplegen.



- Op koelbaden, de circuitbeveiliging op de achterkant van het bad in stand **I** zetten.
- Voor alle units, de circuitbeveiliging op de achterkant van de thermostaat kop in stand **I** zetten, de blauwe LED op het voorpaneel gaat branden
- Druk op , het Start-display verschijnt.
- Controleren of er een kader rond het stopsymbool staat, als dit niet zo is, de pijltoetsen gebruiken om naar het symbool te navigeren.
- Druk op . De unit zal starten en het startsymbool zal in een stopsymbool veranderen (  ). De pomp zal onmiddellijk starten, maar het duurt 30 seconden voor de compressor start.

Op koelunits, de circuitbeveiliging op de achterkant van het bad in stand **O** zetten.

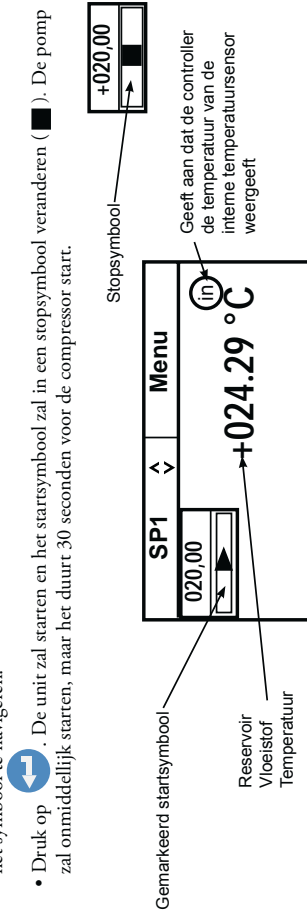

Start-display

Na de start moet u alle externe leidingaansluitingen controleren op lekken.

De secties **SP1** en **Menu** boven in het display worden gebruikt om de instellingen van de controller te bekijken en/of te veranderen. Ze worden in de handleiding gedetailleerd toegelicht.

Druk, indien gewenst, op  om de Status-displays op te roepen.

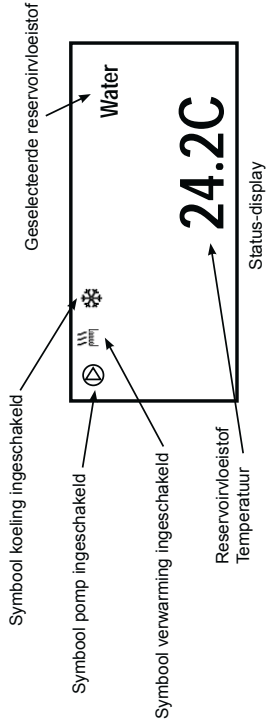

Druk, indien gewenst, op  om tussen de Start/Status-displays om te schakelen.

## Uitschakelen

Controleren of er een kader rond het stopsymbool staat, als dit niet zo is, de pijltoetsen gebruiken om naar het symbool te navigeren.

Druk op . De unit zal stoppen en het stopsymbool zal in een startsymbool veranderen (  ).

Druk op . Het scherm van de thermostaat wordt leeg en de blauwe LED licht op.

De circuitbeveiliging op de achterkant van de thermostaat kop in stand **O** zetten. De blauwe LED zal uitgaan.

### Acceptabele vloeistoffen:

Alleen SC 100, SC 150 en SC 150L units		Alleen AC 150/AC 200 units	
Vloeistof	Hoog °C	Vloeistof	Hoog °C
Water	+100	Water	+100/+100
Glycol-Water	+100	Glycol-Water	+100/+100
Overige	+100	SIL 100	+75/+75
		SIL 180	+200/+150
		SIL 300	+200/+150
		SYNTH 60	+45/+45
		SYNTH 260	+200/+150
		Overige	+200/+150

### Toegestane vloeistoffen:

Systeemlimieten toegestane vloeistoffen:		Systeemlimieten toegestane vloeistoffen:	
Vloeistof	Hoog °C	Vloeistof	Hoog °C
Water	+100	Water	+100/+100
Glycol-Water	+100	Glycol-Water	+100/+100
Overige	+100	SIL 100	+75/+75
		SIL 180	+200/+150
		SIL 300	+200/+150
		SYNTH 60	+45/+45
		SYNTH 260	+200/+150
		Overige	+200/+150

### Alleen SC 150 en SC 150L units:

Vloeistof	Hoog °C	Laag °C
Water	+100	+5
Glycol-Water	+100	-30
Overige	+100	-30
SIL 100	+75	-28
SIL 180	+150	-28
SIL 300	+150	+80
SYNTH 60	+45	-10
SYNTH 260	+150	+45

**⚠ Den här snabbstartguiden är endast avsedd att användas vid den första starten. För övriga procedurer ska du läsa handboken. Om du är osäker på något av nedanstående steg ska du också ladda ned och läsa handboken innan du fortsätter.**

**Säkerhet:**

- Badet är endast avsett för inomhusbruk. Placera aldrig badet på ett ställe som är onormalt varmt, fuktigt eller dåligt ventilerat, eller där frätande material förekommer.
- Anslut badet till ett jordat eluttag.
- För Sahara bad och frisående termostater, Fäst jordningsbandet till toppen av metalltank.
- Använd aldrig utrustningen om nåtsladden är skadad.
- Kylmediana är tyngre än luft och kommer att tränga undan syret, vilket leder till medvetlöshet. Ett läckande kylmedium orsakar brännskador om du kommer i kontakt med huden. Läs märkplåten på badet och senaste MSDS:n från tillverkaren om hanteringsrutiner och kassering.
- Var försiktig när du flyttar badet. Plötsliga stötar eller fall kan skada dess komponenter. Stäng alltid av utrustningen och dra ut nåtsladden innan du flyttar den.
- Använd aldrig utrustning som är skadad eller läcker.
- Använd aldrig utrustningen om badets vätskebehållare är tom.

**Du behöver följande för att komma igång:**

- en skiftnyckel
- lämpliga slangar eller rör
- slangklämmor av lämplig storlek.

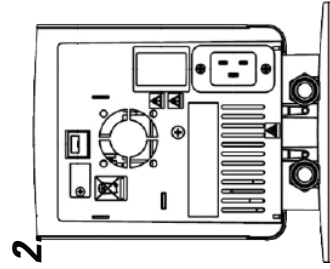
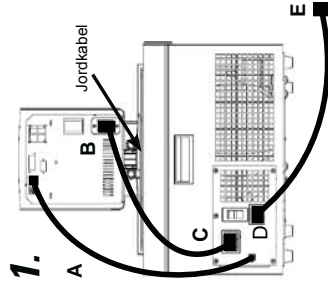

- Säkerställ att inga slangar kommer i kontakt med nåtsladden.
- Extrema drifttemperaturer leder till extrema temperaturer vid slangytan. Delta blir ännu mer kritiskt med metallmunstycken.
- Kontrollera att den slang du har valt uppfyller kraven för maxtemperatur och maxtryck.
- Utsätt inte slangarna för mekaniskt slitage och kontrollera att eventuella böjningsradier som angetts inte överskrids.
- Stäng alltid av cirkulatoren och dra ut nåtsladden från strömkällan innan du installerar den plattformen (tillval) eller byggen (tillval).
- Begränsa den högsta temperaturinställningen för akrylbad till den temperatur som anges på etiketten på badets framsida: 80 °C.
- Använd endast de godkända vätskor som visas i tabell 1. Innan du använder någon vätska som kan tänkas komma i kontakt med huden ska du läsa MSDS:n från tillverkaren om hanteringsrutiner och kassering. Läs även i MSDS:n om ventilationskrav.

Kretsskyddet är utformat för att skydda cirkulatoren. Nåtsladden till cirkulatoren är utformad för att fungera som en fränkopplingsenhet. Placera cirkulatoren så att du enkelt kommer åt nåtsladden.

Läs märkplåten på badets baksida för särskilda elektriska krav. Spänningsavvikelser på ± 10 % är tillåtna. Eluttaget måste vara klassat som lämpligt för den totala strömförbrukningen.

- Säkerställ att inte sladdarna kommer i kontakt med något av de anslutna rören eller någon av de anslutna slangarna.

**1A. För kylbad ska alla kommunikationsanslutningar och elektriska anslutningar göras före start.**

- Anslut aldrig styrenhetens strömningång (B) till ett eluttag. Strömningången C får endast anslutas till cirkulatoren.
- Anslut den medföljande kommunikationskabeln (A) mellan cirkulatoren och badets RJ45-anslutning.

Anslut strömsladden från anslutningen B till anslutningen C på badet.

Anslut badets strömsladd (D) till ett jordat eluttag (E).

**1B. För icke-kylbad går strömsladden (B) direkt till ett jordat eluttag (E).**

**2. Röranslutningar för extern cirkulation sitter på baksidan av cirkulatoren.**

- ● är återflödet från den externa enheten. ● → är utflödet till den externa enheten. Ytterdiametern för anslutningarna är 16 mm.

Om du vill kan du ta bort anslutningsmutterarna och tillhörande bricker och installera de medföljande slangplåttarna och slangklämmorna för 8 eller 12 mm.

- För att undvika skador på cirkulatorns rör ska en säkerhetsnyckel på 19 mm användas när de externa anslutningarna tas bort eller installeras.

På STANDARD-cirkulatorer ska den medföljande kopplingen fästas på pumpmunstycket för högsta möjliga tryck till den externa enheten. Kontrollera att dräneringsporten på badets framsida är stängd och att alla röranslutningar är säkra.

Placera eventuella enhetsbehållare i badet före fyllning för att undvika spill.

Fyll badets arbetsområde från 2,0 till 4,0 cm under den övre kanten.

- Undvik överfyllning; oljebaserade vätskor expanderar när de värms upp.

- Låt kylbad stå i upprätt läge i ~25 °C i 24 timmar före start.

**Tabell 1. Godkända vätskor:**

- Alla cirkulatorer:  
 Filtreter/enkeldestillerat vatten (pH 7–8)  
 Avjoniserat vatten (1–3 MΩ-cm, kompenserat)  
 Destillerat vatten med Nalco-biocid/-hämmare  
 Destillerat vatten med klor (5 ppm)  
 0–75 % laboratorieklassad glykol/vatten  
 Endast SC 150, SC 150L, AC 150 och AC 200:  
 SIL 100 SYNTH 60  
 SIL 180 SYNTH 260
- Om vatten med en temperatur över 80 °C används till att övervaka vätskenivån kräver det regelbundna påfyllningar. Det bildas även ånga.
  - Vatten/glykolblandningar måste fyllas på med rent vatten annars ökar procenthalten glykol, vilket leder till hög viskositet och försämrade prestanda.

Starta inte cirkulatoren förrän vätska har fyllts på i badets behållare. Se till att ha extra vätska till hands.



Kontrollera HTC är helt medsols.  
 På kylbad ska kretsskyddet på baksidan av badet ställas i läget I.  
 På alla cirkulatorer ska kretsskyddet på baksidan ställas i läget I. Den blå lysdioden på frontpanelen tänds.

**3. Tryck på [ ] så visas startdisplayen.**

Kontrollera att startsymbolen [ ] lyser. Om den inte gör det använder du pilangenterna till att navigera till symbolen.

**3.**

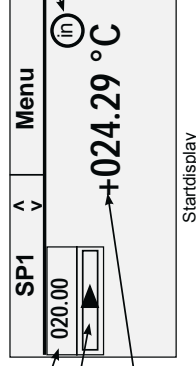

Tryck på [ ] . Cirkulatorn startar och startsymbolen ändras till en stoppsymbol [ ]. Pumpen startar direkt, men för kompressorn tar det 30 sekunder.

4. Om du vill kan du trycka på [ ] för att visa statusdisplayen. Tryck på [ ] för att växla mellan start- och statusdisplayen.

**4.**

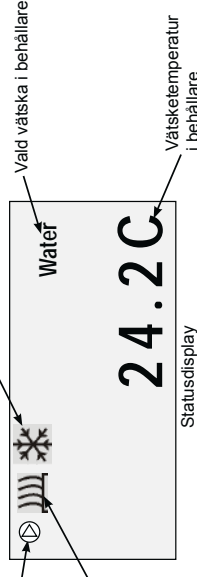

Efter start ska alla röranslutningar kontrolleras så att de inte läcker.

Justera säkerhetsenheten för avstängning vid höga temperaturer (High Temperature Cutout, HTC) enligt anvisningarna i handboken.



# A Bu hızlı başlangıç kılavuzu yalnızca ilk çalıştırma prosedürüne yöneliktir. Diğer tüm prosedürler için kılavuzu bakın. Ayrıca, burada yer alan adımlarla ilgili emin olmadığınız noktalar varsa devam etmeden önce kılavuzu indirin.

## Güvenlik:

- Banyo yalnızca kapalı mekanda kullanıma yöneliktir. Banyoyu hiçbir zaman aşırı sıcak, nemli, yerleri havalandırması olmayan veya aşındırıcı maddelerin bulunduğu bir ortama yerleştirmeyin.
- Banyoyu uygun şekilde topraklanmış bir prize bağlayın.
- Sahra, banyoları ve bağımsız portlu sirkülatörleri için, güvenli, topraklama, metal deposu.
- Güç kablosu hasarlı ekipmanı asla çalıştırmayın.
- Soğutucu akışkanlar havadan ağır olduklarından ortamdaki oksijenin yerine geçecek biling kaybona olabilir. Sızan soğutucu akışkanlarla temas edilmesi ciddi yanıklara yol açar. Kullanıma ilgili önlemler ve ürünün altıması hakkında bilgi için banyonun ad plakasına ve üreticinin güncel Malzeme Güvenlik Bilgi Formuna (MSDS) bakın.
- Banyoyu taşıırken dikkatli olun; ani sarsıntılar veya ürünün düşürülmesi bileşenlere zarar verebilir. Ekipmanı taşımadan önce mutiaka kapalı konuma getirin ve şebeke bağlantısını kesin.
- Hasarlı veya sızıntı yapan ekipmanı asla çalıştırmayın.

## Başlangıç için gerekli malzemeler:

- İngiliz anahtarı
- Uygun hortum veya boru
- Uygun boyda hortum kelepçeleri

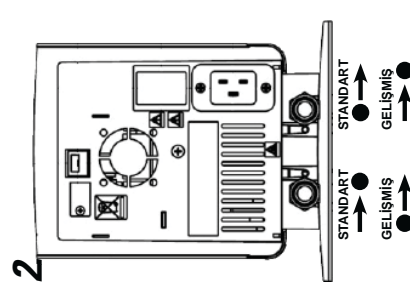
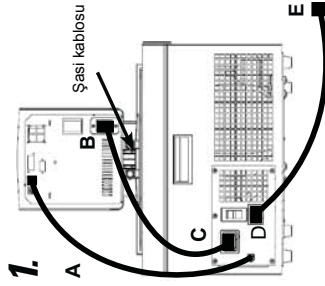

- Banyonun haznesinde sıvı yokken ekipmanı asla çalıştırmayın.
- Hortumlardan hiçbirinin güç kablosuyla temas etmediğinden emin olun.
- Aşırı çalışma sıcaklıklarını tüp yüzeyinin aşırı ısınmasına yol açacaktır; bu durum, metal nozüller kullanımında daha da ciddi bir hal alır.
- Seçtiğiniz hortumların maksimum sıcaklık ve basınç gereksinimlerini karşıladığından emin olun.
- Hortumları mekanik gerilime maruz bırakmayın ve belirtilen bükme yarıçaplarının aşmadığından emin olun.
- İsteğe bağlı platformu veya köprüyü kurmadan önce mutiaka sirkülatörü kapatın ve güç kablosunun güç kaynağı bağlantısını kesin.
- Akrilik banyonun maksimum üst sıcaklık ayarını, banyonun ön tarafındaki etikette belirtilen sıcaklık değeri olan 80°C ile sınırladın.
- Yalnızca Tablo 1'de gösterilen onaylı sıvıları kullanın. Sıvıyla temasın gerçekleşebileceği yerlerde herhangi bir sıvı kullanmadan önce kullanımına ilgili önlemler ve ürünün altıması hakkında bilgi için üreticinin MSDS belgesine bakın. Havalandırma gereksinimleri için de MSDS belgesine bakın.

Devre kortması, sirkülatörün kortmaması için tasarlanmıştır. Sirkülatörün hat kablosu, bağlantı kesme aracı olarak kullanılmak üzere tasarlanmıştır; sirkülatörü kabloya rahatlıkla erişilebilecek bir şekilde konumlandırın.

Spesifik elektrik gereksinimleri için banyonun arka tarafındaki ad plakasına bakın.  $\pm 10\%$ luk gerilim sapmalarına izin verilir. Priz, toplam güç tüketimine uygun değerde olmalıdır.

- Kabloların boru bağlantılarıyla veya hortumlarla temas etmediğinden emin olun.
- Soğutmalı banyolar için ürünü çalıştırmadan önce ürünüle birlikte verilen tüm iletim ve elektrik bağlantılarını yapın.
- Kontrolör güç girişini (B) asla bir prize bağlamayın. Güç çıkışı (C) asla sirkülatör dışında bir yere bağlamayın.

Ürünüle birlikte verilen iletim kablosunu (A) kullanarak sirkülatör ile banyo RJ45 konektörlerini birbirine bağlayın.

Güç kablosunu kullanarak konektörü (B), banyo üzerindeki konektöre (C) bağlayın. Banyonun güç kablosunu (D) topraklı bir prize (E) bağlayın.

**1B. Soğutmasız banyolar için güç kaynağı (B) doğrudan topraklı bir prize (E) bağlanı:**

- Harcı sirkülayyon için boru bağlantılar sirkülatörün arka tarafında bulunmaktadır.  $\rightarrow$  ● harcı uygulamadan gelen dönüş akışdır: ● harcı uygulamaya giden çıkış akışdır. Bağlantılar 16 mm'lik bir dış çapa sahiptir.

İsteğe bağlı olarak, rakotdan ve plakadan sökerek ürünüle birlikte verilen 8 veya 12 mm'lik hortum uçlarını ve kelepçelerini takabilirsiniz.

- Sirkülatör borularının zarar görmesini önlemek için harcı bağlantılar sökerek/takarken deslek anahtar olarak bir 19 mm anahtar kullanın.

STANDART sirkülatörlerde harcı uygulamaya maksimum basıncın sağlanması için ürünüle birlikte verilen bağlantı parçasını pompa nozülüne takın.

Banyonun ön tarafındaki tahliye portunun kapalı olduğundan ve tüm boru bağlantılarının sabitlendiğinden emin olun.

Dökülmeleri önlemek için dolun yapmadan önce tüm uygulama kaplarını banyonun içine yerleştirin.

Banyo çalışma alanını en üst kısımdan 2,0 cm (0,7") ila 4,0 cm (1,5") pay bırakarak doldurun.

## Tablo 1. Onaylı Sıvılar:

Tüm sirkülatörler:

Filtrelenmiş/bir kez damıtılmış su (pH 7-8)

Deiyonize su (1-3 MΩ-cm, dengelenmiş)

Nalco biyosit ve inhibitör eklenmiş damıtılmış su

Klor eklenmiş damıtılmış su (5 ppm)

%60 ila 75 Laboratuvar Sıfıfı Glikol/Su

Yalnızca SC 150, SC 150L, AC 150 ve AC 200:

SIL 100 SIL 300 SYNTH 60

SIL 180 SYNTH 260

80°C'nin üzerinde su kullanırken sıvı seviyesini izleyin; sık sık ekleme yapması gerekecektir. Ayrıca buhar da oluşacaktır.

Su/glikol karışımları saf su ile ekleme yapılmasını gerektirir; aksi halde glikol yüzdesi artarak yüksek viskoziteye ve düşük performansa neden olur.

Daha fazla miktarda sıvı doldurmayın; yağ bazı sıvılar ısındığında genleşir.

Soğutmalı banyoları, çalıştırmadan önce ~25°C'de dik konumda 24 saat süreyle beklemeye bırakın.



HTC

HTC

Banyo haznesine sıvı eklenmeden sirkülatörü çalıştırmayın. Hazırda fazladan sıvı bulunduğundan.

Soğutmalı banyolar için banyonun arka tarafında bulunan devre koruyucusunu I konumuna getirin.

Tüm sirkülatörler için arka tarafa bulunan devre koruyucusunu I konumuna getirin. Ön paneldeki mavi LED yanar.

## 3

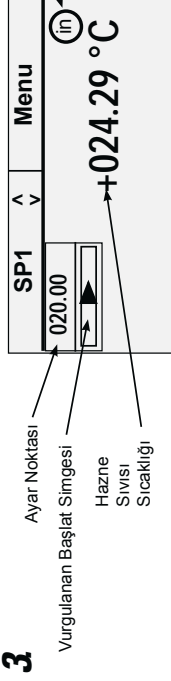

3. düğmesine basın, Başlangıç Ekranı görüntülenir.

Başlat simgesinin  $\blacktriangle$  vurgulandığından emin olun; simge vurgulanıyorsa ok tuşlarını kullanarak simgeye gidin.

4. İsterseniz  $\text{ESC}$  düğmesine basarak Durum Ekranını görüntüleyebilirsiniz. Başlangıç/Durum Ekranları arasında geçiş yapmak için çalışması 30 saniye kadar sürer.

4. İsterseniz  $\text{ESC}$  düğmesine basarak Durum Ekranını görüntüleyebilirsiniz.

4. İsterseniz  $\text{ESC}$  düğmesine basarak Durum Ekranını görüntüleyebilirsiniz.

## 4

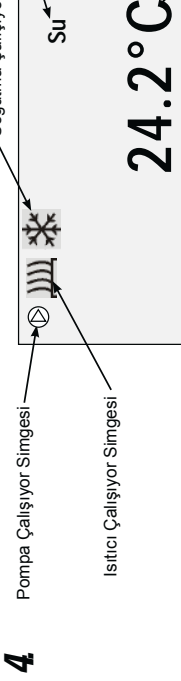

Ürünü çalıştırdıktan sonra sızıntı olup olmadığını belirlemek için tüm boru bağlantılarını kontrol edin.

Yüksek Sıcaklık Kapatma (HTC) güvenli bir cihazı ayarlayın; kılavuza bakın.

# Preface

## WEEE

This product is required to comply with the European Union's Waste Electrical & Electronic Equipment (WEEE) Directive 2012/19/EU. It is marked with 'wheelie bin' symbol:



Thermo Fisher Scientific has contracted with one or more recycling/disposal companies in each EU Member State, dispose of or recycle this product through them. Further information on Thermo Fisher Scientific's compliance with these Directives is available at:

[www.thermoscientific.com/WEEERoHS](http://www.thermoscientific.com/WEEERoHS)

## After-sale Support

Thermo Fisher Scientific is committed to customer service both during and after the sale. If you have questions concerning the bath operation, or questions concerning spare parts or Service Contracts, call our Sales, Service and Customer Support phone number, see this manual's inside cover for contact information.



Sample Nameplate

There can be up to three nameplates located on the rear of the bath. Before calling, please obtain the serial number printed on the complete system nameplate located on the upper rear of the bath.

### Nameplate

Refer to nameplate when calling for after-sale support

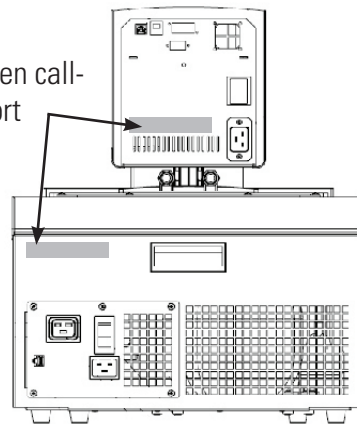

Nameplates (Typical Locations)



## Feedback

We appreciate any feedback you can give us on this manual. E-mail us at [tcmanuals@thermofisher.com](mailto:tcmanuals@thermofisher.com). Be sure to include the manual part number and the revision date listed on the front cover.

## Warranty

Thermo Scientific Laboratory Temperature Control Products have a warranty against defective parts and workmanship for 36 months from date of shipment. See back page of this manual for more details.

## Unpacking

Retain all cartons and packing material until the bath is operated and found to be in good condition. If the bath shows external or internal damage contact the transportation company and file a damage claim. Under ICC regulations, this is your responsibility.

If an immersion circulator was purchased without a bath, carefully remove the label and small piece of Styrofoam securing the float switch before using.



**Refrigerated baths should be left in an upright position for 24 hours before starting. This will ensure the lubrication oil has drained back into the compressor. ▲**

## Section 1 Safety

### Safety Warnings

Make sure you read and understand all instructions and safety precautions listed in this manual before installing or operating your circulator. If you have any questions concerning the operation of your circulator or the information in this manual, please contact us. See inside cover for contact information.



**DANGER** indicates an imminently hazardous situation which, if not avoided, *will* result in death or serious injury.



**WARNING** indicates a potentially hazardous situation which, if not avoided, *could* result in death or serious injury.



**CAUTION** indicates a potentially hazardous situation which, if not avoided, may result in minor or moderate injury. It also alerts against unsafe practices.



The lightning flash with arrow symbol, within an equilateral triangle, is intended to alert the user to the presence of non-insulated "dangerous voltage" within the circulator's enclosure. The voltage magnitude is significant enough to constitute a risk of electrical shock.



This label indicates the presence of hot surfaces.



This label indicates read the manual.



This label indicates a flammable refrigerant is used.

**Observe all warning labels. ▲**

**Never remove warning labels. ▲**



**Leave refrigerated baths in an upright position at room temperature (~25°C) for 24 hours before starting. This ensures the lubrication oil drains back into the compressor. ▲**

**The circuit protector located on the rear of the circulator is not intended to act as a disconnecting means. ▲**

**Operate the circulator using only the supplied line cord. The circulator's power cord is used as the disconnecting device, it must be easily accessible at all times. ▲**

Never operate the bath with the immersion circulator removed. ▲

Do not mount the immersion circulator backwards; the line cord could contact the reservoir fluid. Ensure the electrical cords do not contact any of the plumbing connections or tubing. ▲

Never place the circulator in a location or atmosphere where excessive heat, moisture, or corrosive materials are present. ▲

Ensure the tubing you select meets your maximum temperature and pressure requirements. ▲

Ensure all communication and electrical connections are made prior to starting the circulator. ▲

Never operate the circulator without fluid in the reservoir. ▲

Oil-based fluids expand when heated. Fill the reservoir only to the minimum level. ▲

Use only the approved fluids listed in this manual. Using other fluids voids the warranty. ▲

Polyphenylene oxide (PPO) Bath Circulators are used with water only. ▲

Other than water, before using any approved fluid, or when performing maintenance where fluid contact is likely, refer to the manufacturer's SDS and EC Safety Data Sheet for handling precautions. ▲

When using ethylene glycol and water, check the fluid concentration and pH on a regular basis. Changes in concentration and pH can impact system performance. ▲

Do not clean the circulator with solvents, use a soft cloth and water. ▲

Drain the reservoir before it is transported, and/or stored. ▲

Always turn the circulator off and disconnect the supply voltage from its power source before moving or before performing any service or maintenance procedures. ▲

Transport the circulator with care. Sudden jolts or drops can damage its components. ▲

Refer service and repairs to a qualified technician. ▲

The user is responsible for decontamination if hazardous materials are spilled. Consult the manufacturer regarding decontamination and or cleaning agents compatibility. ▲

Performance of installation, operation, or maintenance procedures other than those described in this manual may result in a hazardous situation and voids the manufacturer's warranty. ▲



The circulators construction provides protection against the risk of electrical shock by grounding appropriate metal parts. The protection will not function unless the power cord is connected to a properly grounded outlet. It is the users responsibility to assure a proper ground connection is provided. ▲

For Sahara baths, and stand-alone immersion circulators, use the supplied nut and washer to secure the grounding strap to the top of the metal tank. ▲

Many refrigerants which may be undetectable by human senses are heavier than air and will replace the oxygen in an enclosed area causing loss of consciousness. Contact with leaking refrigerant will cause skin burns. Refer to the chiller's nameplate for the type of refrigerant used and then the refrigerant's SDS for additional information. ▲

Ensure, that no toxic gases can be generated by the fluid. Flammable gases can build up over the fluid during usage. ▲

Ensure the fluid is at a safe temperature (~40°C) before handling or draining. ▲

Never operate damaged or leaking equipment, or with any damaged cords. ▲

Never operate the circulator or add fluid to the reservoir with panels removed. ▲

## Personal Protective Equipment

There are no special personal protective equipment requirements needed to perform normal operation, unless required by the manufacturer of the fluid you are using. Consult their Safety Data Sheet and/or EC Safety Data Sheet. We do recommend wearing eye protection and gloves.

## Training

The user must review and understand all the sections in this manual before operating the bath.



## Grundlegende Sicherheitsanweisungen Laborbäder

Falls Sie eine dieser Anweisungen nicht verstehen, lesen Sie das Handbuch oder kontaktieren Sie uns bevor Sie weitermachen.

### Sicherheit, alle Produkte:

 weist auf eine unmittelbar gefährliche Situation hin, die, falls sie nicht vermieden wird, zum Tod oder schweren Verletzungen führt.

 weist auf eine potenziell gefährliche Situation hin, die zu ernsthaften Verletzungen oder zum Tod führen kann, wenn sie nicht vermieden wird.

 weist auf eine potenziell gefährliche Situation hin, die, falls sie nicht vermieden wird, zu leichteren bis mittelschweren Verletzungen führen kann. Es kann auch verwendet werden, um gegen unsichere Praktiken zu warnen.

 ist dafür vorgesehen, den Benutzer vor dem Bestehen einer nicht isolierten "gefährlichen Spannung" im Gehäuse des Zirkulators zu warnen. Die Höhe der Spannung ist bedeutend genug, sodass ein Stromschlag-Risiko besteht.

 weist auf das Vorhandensein heißer Oberflächen hin.

 weist darauf hin, das Handbuch zu lesen.

 Dieses Etikett zeigt an, dass ein entzündbares Kältemittel verwendet wird.

Benutzen Sie das Bad keinesfalls als steriles oder an Patienten angeschlossenes Gerät. Außerdem ist das Bad nicht für den Gebrauch an Orten mit Gefahrenklasse I, II oder III, wie in den nationalen Vorgaben für elektrische Geräte definiert, ausgelegt.

Stellen Sie das Bad niemals an einer Stelle oder in einer Atmosphäre auf, wo übermäßige Temperaturen, Feuchtigkeit, oder korrosive Materiale vorhanden sind. Lesen Sie im Benutzerhandbuch über die Betriebsparameter.

Lassen Sie vor dem Start die gekühlten Bäder in aufrechter Position bei Raumtemperatur (~25°C) 24 Stunden lang stehen. Dies stellt sicher, dass das Schmieröl wieder in den Kompressor zurückfließt.

Schließen Sie das Bad an eine vorschriftsmäßig geerdete Steckdose an.

Die Leitungsschutzvorrichtung auf der Rückseite des Bades ist nicht als trennvorrichtung vorgesehen.

Bedienen Sie den Zirkulator, indem Sie nur das mitgelieferte Steckerkabel verwenden. Falls das Netzkabel des Zirkulators als Trennvorrichtung benutzt wird, muss es zu jedem Zeitpunkt leicht zugänglich sein.

Stellen Sie sicher, dass die elektrischen Leitungen keine der Sanitäranschlüsse oder Verrohrungen berühren.

Legen Sie niemals Netzspannung an einen der Kommunikationsanschlüsse des Bades an.

Stellen Sie sicher, dass die von Ihnen ausgewählte Verrohrung, ihre Anforderungen für Höchsttemperatur und -Druck erfüllt.

Stellen Sie sicher, dass alle elektrischen, und falls möglich, auch Kommunikationsanschlüsse vor dem Start ausgeführt werden.

Die verwendeten Kühlmittel sind schwerer als Luft und werden im Fall einer Leckage den Sauerstoff ersetzen, was zu Bewusstlosigkeit führt. Kontakt mit auslaufendem Kühlmittel führt zu Hautverbrennungen. Den Typ des verwendeten Kühlmittels entnehmen Sie dem Namensschild des Zirkulators und zusätzliche Informationen dem neuesten US Sicherheitsdatenblatt (SDS) des Herstellers, vormals MSDS, und dem EU Sicherheitsdatenblatt.

Stellen Sie sicher, dass die Auslassanschlüsse des Behälters geschlossen und alle Rohranschlüsse gesichert sind. Stellen Sie außerdem sicher, dass jegliche Reste vor dem Abfüllen gründlich entfernt werden.

Um Verschütten zu vermeiden, stellen Sie Ihre Behälter vor dem Abfüllen ins Bad.

Betreiben Sie das Bad niemals ohne Flüssigkeit im Behälter.

Öl-basierte Flüssigkeiten dehnen sich bei Erwärmung aus. Vermeiden Sie die Überfüllung des Behälters.

Benutzen Sie nur Flüssigkeiten, die in diesem Handbuch aufgelistet sind. Bei Verwendung anderer Flüssigkeiten wird die Garantie ungültig. Verwenden Sie niemals 100%-iges Glykol.

Bei Gebrauch von Wasser bei über 80°C, überwachen Sie den Flüssigkeitsstand sorgfältig, denn häufiges Ablöschen wird nötig sein. Es generiert auch Dampf.

Wasser-Glykol-Mischungen benötigen das Ablöschen mit reinem Wasser, andernfalls steigt der Anteil von Glykol an, was zu hoher Viskosität und schwacher Leistung führt.

Außer bei Wasser, entnehmen Sie den Umgang betreffende Vorsichtsmaßnahmen vor der Verwendung einer zugelassenen Flüssigkeit, oder bei Wartungsarbeiten wo der Kontakt mit der Flüssigkeit wahrscheinlich ist, dem SDS und EC Sicherheitsdatenblatt.

Stellen Sie sicher, dass die Flüssigkeit keine giftigen Gase generieren kann. Über der Flüssigkeit können sich im Gebrauch entzündbare Gase bilden.

Prüfen Sie beim Gebrauch von Ethylen-Glykol und Wasser, regelmäßig die Konzentration und den pH-Wert der Flüssigkeit. Änderungen der Konzentration und des pH-Werts können die Leistung des Systems beeinträchtigen.

Stellen Sie sicher, dass der Übertemperatur-Abschaltpunkt niedriger als der Brandpunkt der ausgewählten Wärmeträgerflüssigkeit eingestellt wird.

Die höchste Betriebstemperatur, gemäß Definition in EN 61010 (IEC 1010), muss auf 25°C unter dem Brandpunkt der Badflüssigkeit begrenzt werden.

Stellen Sie sicher, dass die Flüssigkeit vor dem Umgang oder dem Abfluss eine sichere Temperatur (unter 40°C) hat.

Benutzen Sie niemals beschädigte oder undichte Ausrüstung, und auch keine beschädigten Kabel.

Betreiben Sie das Bad niemals ohne Flüssigkeit im Behälter.

Betreiben Sie keinesfalls das Bad und füllen Sie den Behälter nicht mit Flüssigkeit auf, wenn die Tafeln entfernt wurden.

Bad nicht mit Lösungsmitteln reinigen, benutzen Sie ein weiches Tuch und Wasser.

Lassen Sie den Behälter vor dem Transport und/oder der Lagerung aus, nahe oder unter den Gefrieremperaturen.

Schalten Sie das Bad immer ab und trennen Sie vor dem Umzug oder der Durchführung von Instandhaltungs- oder Wartungsarbeiten. Lassen Sie die Instandhaltung und Reparaturen von einem qualifizierten Techniker durchführen.

Transportieren Sie das Bad mit Sorgfalt. Plötzliche Stöße oder das Herabfallen kann seine Komponenten beschädigen.

Der Benutzer ist verantwortlich für die Dekontaminierung, falls Gefahrenstoffe verschüttet werden. Halten Sie Rücksprache mit dem Hersteller bezüglich der Kompatibilität von Dekontaminierungs- und/oder Reinigungsmitteln.

Falls das Bad bei niedrigen Temperaturen transportiert und/oder gelagert werden soll, muss es ausgelassen und anschließend mit einer 50/50 labortauglichen Glykol-Wasser-Mischung ausgespült werden. Die Außerbetriebnahme darf nur von einem Fachhändler unter Verwendung zertifizierter Ausrüstung durchgeführt werden. Alle einschlägigen Vorschriften müssen befolgt werden.

Die Ausführung von Installations-, Betriebs- oder Wartungsprozeduren, außer den im Handbuch beschriebenen, kann zu einer gefährlichen Situation führen und macht die Herstellergarantie ungültig.

Verwenden Sie für Sahara-Bade und alleinstehende Eintauch-Zirkulatoren die mitgelieferten Muttern und Unterlegescheiben zur Befestigung des Erdungsbands am Oberteil des Metallbehälters.

Betreiben Sie das Bad keinesfalls, wenn der Eintauch-Zirkulator entfernt ist.

Montieren Sie den Eintauch-Zirkulator keinesfalls umgekehrt; das Steckerkabel könnte mit der Behälterflüssigkeit in Berührung kommen.

Durchsichtige Acryl- und Polyphenylen-Oxid (PPO)-Bäder werden nur mit Wasser benutzt.

Stellen Sie die Software des Bades so ein, dass sie der verwendeten Flüssigkeit entspricht.

## Einbau von Arktis-, Gletscher und Sahara-Badzirkulatoren:

Stellen Sie sicher, dass die elektrischen Leitungen keine der Rohranschlüsse oder Verrohrungen berühren. Installieren Sie bei Gekühlten Bädern das mitgelieferte RJ45 abgeschirmte Kabel zwischen dem Eintauchzirkulator und den RJ45 Bad-Steckverbindungen (so wie beim Ethernet). Dies ist für einen vorschriftsmäßigen Betrieb erforderlich.

Installieren Sie bei gekühlten Bädern das Netzkabel zwischen der Steckverbindung auf der Rückseite des Steuergeräts, A, und der Steckverbindung auf der Rückseite des gekühlten Bades, B. Schließen Sie das Netzkabel des Bades, C, an eine geerdete Steckdose an.

Schließen Sie bei gekühlten Bädern nie den Steuergerät-Netzstecker, A, an eine Steckdose an. Verbinden Sie die Steckdose, B, ausschließlich mit einem Eintauch-Zirkulator.

Schließen Sie bei nichtgekühlten Bädern das Netzkabel des Bades, C, an eine geerdete Steckdose an.

Die Rohranschlüsse für externe Zirkulation befinden sich auf der Rückseite des Eintauch-Zirkulators.

➔ ist der Rücklauf von der externen Anwendung. ● ➔ ist der Vorlauf zur externen Anwendung (Zulaufseite). Die Anschlüsse sind 16 mm O.D. Entfernen Sie die Überwurfmutter und Scheiben, um die mit dem Zirkulator mitgelieferten 8 mm oder 12 mm Schlauchbinder und -Klammern anbringen zu können.

Um Schäden an den Rohranschlüssen des Zirkulators zu vermeiden, verwenden Sie einen 19 mm Stützschlüssel, wenn Sie Anschlüsse entfernen/einbauen.

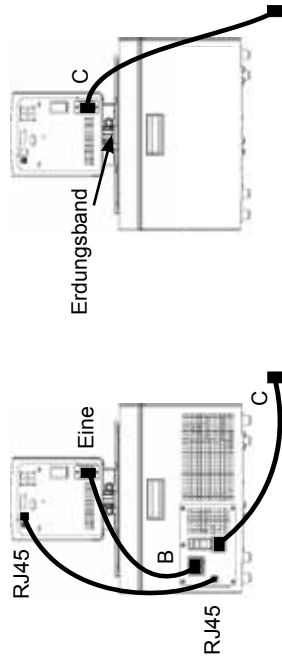



## Consignes de sécurité Bains de laboratoire

**Si vous ne comprenez pas l'une de ces instructions, reportez-vous au manuel ou contactez-nous avant d'effectuer une opération.**

**Sécurité, tous les produits :**

 indique une situation de danger imminent qui, si elle n'est pas évitée, peut entraîner une blessure grave ou mortelle.

 indique une situation de danger potentiel qui, si elle n'est pas évitée, pourrait entraîner une blessure grave ou mortelle.

 indique une situation de danger potentiel qui, si elle n'est pas évitée, peut entraîner une blessure légère à modérée. Ce symbole est également utilisé pour mettre en garde contre des pratiques dangereuses.

 ce symbole avertit l'utilisateur de la présence d'une « tension dangereuse » non isolée dans l'enceinte du circulateur. La magnitude de la tension est suffisante pour constituer un risque d'électrocution.

 indique la présence de surfaces chaudes.

 indique qu'il convient de lire le manuel.

 Cette étiquette indique qu'un réfrigérant inflammable est utilisé.

N'utilisez pas le bain comme appareil stérile ou relié au patient. En outre, le bain n'est pas prévu pour une utilisation dans des emplacements dangereux de classe I, II ou III, tels que définis par le National Electrical Code.

Ne placez jamais le bain dans un endroit ou sous une atmosphère présentant un excès de chaleur, d'humidité ou des matériaux corrosifs. Reportez-vous au mode d'emploi pour connaître les paramètres de fonctionnement.

Conservez les bains réfrigérés en position verticale à température ambiante (~25°C) pendant 24 heures avant leur démarrage. Cette opération permet de rediriger l'huile de lubrification vers le compresseur.

Branchez le bain sur une prise correctement mise à la terre.

Le protecteur de circuit situé à l'arrière du bain n'est pas destiné à faire office de dispositif de sectionnement.

Faites fonctionner le circulateur uniquement avec le cordon d'alimentation fourni. Si le cordon d'alimentation du circulateur est utilisé comme dispositif de sectionnement, il doit être facilement accessible à tout moment.

Vérifiez que les cordons électriques ne sont pas en contact avec un tuyau ou un raccordement de plomberie.

Ne mettez jamais les raccordements de communication du bain sous tension.

Vérifiez que les tuyaux choisis répondent à vos exigences maximales de température et de pression.

Vérifiez que tous les raccordements électriques et, le cas échéant, de communication, sont exécutés avant le démarrage.

Les réfrigérants utilisés sont plus lourds que l'air. En cas de fuite, ils chassent l'oxygène et provoquent une perte de connaissance. Tout contact avec la fuite de réfrigérant peut causer des brûlures cutanées.

Reportez-vous à la plaque signalétique du circulateur pour connaître le type de réfrigérant utilisé. Lisez également la fiche de données de sécurité (SDS, anciennement MSDS) américaine la plus récente du fabricant ainsi que la fiche de données de sécurité européenne pour obtenir des informations complémentaires.

Vérifiez que les orifices de vidange du réservoir sont fermés et que les raccordements de plomberie sont bien fixés. Vérifiez également qu'il n'y a pas de résidus avant de procéder au remplissage.

Placez vos contenants dans le bain avant de le remplir afin d'éviter de les renverser.

Les liquides à base d'huile se dilatent lorsqu'ils sont chauffés. Évitez de trop remplir le réservoir.

Utilisez uniquement les liquides approuvés cités dans le manuel. L'utilisation d'autres liquides annule la garantie. N'utilisez jamais du glycol pur.

Si vous utilisez de l'eau à une température supérieure à 80°C, surveillez de près le niveau de liquide. Des remplissages fréquents seront nécessaires. L'eau crée également de la vapeur.

Les mélanges eau/glycol nécessitent des remplissages d'eau pure. Autrement, le pourcentage de glycol augmente, causant ainsi une forte viscosité et de faibles performances.

Excepté pour l'eau, avant d'utiliser un liquide approuvé, ou de procéder à une opération de maintenance pouvant comporter un contact avec le liquide, reportez-vous aux fiches de données de sécurité du fabricant et de l'Union européenne pour connaître les précautions de manipulation.

Vérifiez qu'aucun gaz toxique n'est produit par le liquide. Les gaz inflammables peuvent s'accumuler au-dessus du liquide lors de son utilisation.

Si vous utilisez de l'éthylène glycol et de l'eau, vérifiez régulièrement la concentration du liquide et le pH. Des modifications de la concentration et du pH peuvent affecter les performances du système.

Vérifiez que le point de coupure haute température est défini sous le point de feu pour le liquide caloporteur choisi.

La température de fonctionnement la plus élevée, telle que définie par l'EN 61010 (IEC 1010), doit être limitée à 25°C sous le point de feu du liquide du bain.

Vérifiez que le liquide est à une température sûre (en dessous de 40°C) avant de le manipuler ou de le vider.

Ne faites jamais fonctionner un équipement endommagé, qui fuit ou dont les cordons sont usés.

Ne faites jamais fonctionner le bain lorsque le réservoir est vide.

Ne faites jamais fonctionner le bain ou n'ajoutez jamais de liquide au réservoir lorsque les panneaux sont déposés.

Ne nettoyez pas le bain avec des solvants. Utilisez un chiffon doux et de l'eau.

Vidangez le réservoir avant de le transporter et/ou de le stocker aux températures de congélation ou en dessous.

Éteignez le bain et débranchez la tension d'alimentation de sa source avant de déplacer ou de procéder à une opération de réparation ou de maintenance. Confiez les entretiens et réparations à un technicien qualifié.

Transportez le bain avec précaution. Les secousses ou les chutes peuvent endommager les composants.

L'utilisateur est responsable de la décontamination si des matériaux dangereux sont renversés. Consultez le fabricant pour connaître la procédure de décontamination et/ou la compatibilité des agents de nettoyage.

Il convient de vider et de rincer le bain à l'aide d'un mélange composé à parts égales d'eau et de glycol de qualité de laboratoire s'il doit être transporté et/ou stocké sous des températures basses.

La mise hors service doit être effectuée par un revendeur qualifié à l'aide d'un équipement certifié. Toutes les réglementations en vigueur doivent être respectées.

L'exécution des procédures d'installation, de fonctionnement ou de maintenance autres que celles décrites dans le manuel peuvent créer une situation dangereuse et annuler la garantie du fabricant.

Pour les baigns Sahara, et les circulateurs à immersion autonomes, utilisez l'écrou et la rondelle fournis pour fixer la bride de mise à la terre sur la partie supérieure du réservoir en métal.

Ne faites jamais fonctionner le bain sans le circulateur à immersion.

Ne montez pas le circulateur à immersion vers l'arrière car le cordon peut être en contact avec le liquide du réservoir.

Les baigns à l'acrylique et à l'oxyde de polyphénylène doivent être utilisés uniquement avec de l'eau.

Régalez le logiciel du bain afin de concorder avec le liquide utilisé.

## Installation des circulateurs de bain Arctiq, Glacier et Sahara



Assurez-vous que les cordons électriques n'entrent pas en contact avec l'un des tuyaux ou raccordements de plomberie.

Pour les baigns réfrigérés, installez le câble armé RJ45 entre le circulateur à immersion et les connecteurs RJ45 du bain (similaires à Ethernet). Cette opération est nécessaire pour un bon fonctionnement.

Pour les baigns réfrigérés, installez le cordon d'alimentation depuis le connecteur situé à l'arrière du contrôleur, A, au connecteur situé à l'arrière du bain réfrigéré, B. Branchez le cordon d'alimentation du bain, C, sur une prise reliée à la terre.

Pour les baigns réfrigérés, ne branchez jamais l'entrée électrique du contrôleur, A, sur une prise électrique. Ne branchez jamais la sortie électrique, B, sur un autre dispositif que le circulateur à immersion.

Pour les baigns non réfrigérés, branchez le cordon d'alimentation du bain, C, sur une prise reliée à la terre.

Les raccordements de plomberie pour la circulation externe se situent à l'arrière du circulateur à immersion.  correspond au débit de retour de l'application externe.  correspond au débit de sortie vers l'application externe (côté alimentation). Les branchements ont un diamètre extérieur de 16 mm.

Déposez les écrous de raccord et les plaques pour installer les colliers de serrage et les raccords cannelés fournis avec le circulateur.

Pour éviter d'endommager la plomberie du circulateur, utilisez une clé de 19 mm lors de la dépose ou de l'installation des branchements.

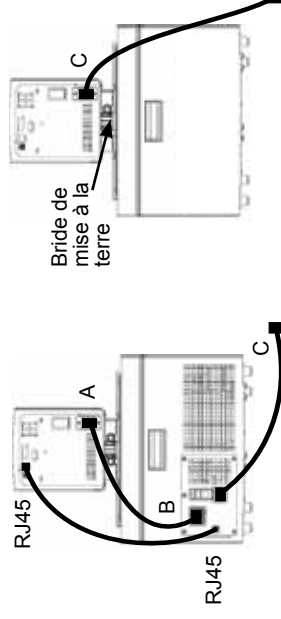



## Instrucciones básicas de seguridad Baños de laboratorio

Si no se entiende alguna de estas instrucciones, consulte el manual o póngase en contacto con nosotros antes de proceder.

### Seguridad, todos los productos:

 indica una situación de peligro inmediato que, si no se evita, provocará la muerte o lesiones graves.

 indica una situación potencialmente peligrosa que, si no se evita, podría tener como resultado lesiones graves o la muerte.

 indica una situación potencialmente peligrosa que, si no se evita, puede ocasionar lesiones leves o moderadas. También se utiliza para alertar de prácticas inseguras.

 está indicado para alertar al usuario de la presencia de "tensión peligrosa" sin aislar dentro del alojamiento del circulador. La magnitud de la tensión es lo suficientemente importante para constituir un riesgo de electrocución.

 indica la presencia de superficies calientes.

 indica que se debe leer el manual.

 Esta etiqueta indica que se utiliza un refrigerante inflamable.

No utilice el baño como dispositivo conectado al paciente o dispositivo estéril. Además, el baño no está diseñado para ser utilizado en lugares peligrosos de Clase I, II o III de acuerdo con el Código Eléctrico Nacional.

Nunca lo coloque en un lugar o una atmósfera donde haya calor excesivo, humedad, ventilación inadecuada o materiales corrosivos. Consulte el manual del usuario para conocer los parámetros de funcionamiento.

Deje los baños refrigerados en posición vertical a temperatura ambiente (~25 °C) durante 24 horas antes de comenzar. De este modo se asegurará de que el aceite de lubricación pase al compresor.

Conecte el baño a una toma correctamente conectada a tierra.

El protector de circuitos situado en la parte posterior del baño no está diseñado para actuar como un medio de desconexión.

Para hacer funcionar el circulador, utilice solamente el cable de línea suministrado. Si el cable de alimentación del circulador se utiliza como dispositivo de desconexión, debe estar accesible en todo momento.

Asegúrese de que los cables eléctricos no tocan ninguna de las conexiones de tuberías o los tubos.

Asegúrese de que los tubos que selecciona cumplen los requisitos de temperatura y presión máximas.

Asegúrese de que todas las conexiones eléctricas y, si procede, las conexiones de comunicación se realizan antes de la puesta en marcha.

Los refrigerantes utilizados son más pesados que el aire y, si hay una fuga, sustituirán al oxígeno, lo que provocará la pérdida de consciencia. El contacto con el refrigerante expulsado provocará quemaduras en la piel. Consulte la placa de datos del circulador para conocer el tipo de refrigerante utilizado y, a continuación, la hoja de datos de seguridad (SDS) más reciente del fabricante para EE.UU., anteriormente conocida como MSDS, así como la hoja de datos de seguridad para la UE a fin de obtener información adicional.

Asegúrese de que los puertos de drenaje del depósito están cerrados y de que todas las conexiones de las tuberías son seguras. Asegúrese también de retirar minuciosamente cualquier residuo antes de proceder con el llenado.

Para evitar salpicaduras, coloque los contenedores en el baño antes de llenarlos.

Nunca utilice el baño sin fluido en el depósito.

Los fluidos con base de aceite se expanden al calentarse. Evite llenar el depósito en exceso.

Utilice solo los fluidos aprobados que se incluyen en el manual. Si utiliza otros fluidos, quedará anulada la garantía. Nunca utilice glicol al 100%.

Si utiliza agua por encima de 80 °C, supervíse detenidamente el nivel del fluido; se precisarán llenados frecuentes. También crea vapor.

Si se utilizan mezclas de agua/glicol será necesario rellenar con agua pura. De lo contrario, el porcentaje de glicol aumentará y provocará una elevada viscosidad y un rendimiento deficiente.

Salvo que se utilice agua, antes de utilizar cualquier fluido aprobado, o cuando realice tareas de

mantenimiento donde es probable que se toque el fluido, consulte el SDS del fabricante y la hoja de datos de seguridad para la CE a fin de conocer las precauciones de manipulación.

Asegúrese de que el fluido no genera gases tóxicos. Los gases inflamables pueden acumularse sobre el fluido durante el uso.

Al utilizar etilenglicol y agua, revise la concentración y el pH del fluido periódicamente. Los cambios en la concentración y el pH pueden afectar al rendimiento del sistema.

Asegúrese de que el punto de corte por sobretemperatura está configurado por debajo del punto de combustión para el fluido de transferencia de calor seleccionado.

La temperatura de trabajo más alta, según establece la norma EN 61010 (IEC 1010), debe limitarse a 25 °C por debajo del punto de combustión del fluido del baño.

Asegúrese de que el fluido se encuentra a una temperatura segura (por debajo de 40 °C) antes de manipularlo o drenarlo.

Nunca utilice un equipo dañado o con fugas, o con algún cable dañado.

Nunca utilice el baño sin fluido en el depósito.

Nunca utilice el baño o añada fluido al depósito con los paneles retirados.

No limpie el baño con disolventes; utilice solamente un paño suave y agua.

Drene el depósito antes de transportarlo y/o guardarlo a temperaturas cercanas a la congelación o por debajo de estas.

Apague siempre el baño y desconecte la tensión de suministro de su fuente de alimentación antes de mover o realizar cualquier procedimiento de servicio o mantenimiento. Dele las tareas de servicio y las reparaciones en un técnico cualificado.

Transporte el baño con cuidado. Las caídas o los impactos repentinos pueden dañar los componentes.

El usuario es responsable de la descontaminación si se derraman materiales peligrosos. Consulte al fabricante lo concerniente a la descontaminación y/o la compatibilidad de los agentes de limpieza.

Si el baño debe transportarse y/o guardarse a bajas temperaturas, es necesario drenarlo y limpiarlo con una mezcla de agua/glicol de grado de laboratorio al 50/50.

El desmantelamiento solo debe ser realizado por un proveedor cualificado que utilice el equipo homologado. Debe cumplirse toda la normativa vigente.

La realización de los procedimientos de instalación, funcionamiento o mantenimiento distintos de los que se describen en el manual pueden dar lugar a situaciones peligrosas y anularán la garantía del fabricante.

Para los baños Sahara, y los circuladores de inmersión independientes, utilice la tuerca y la arandela suministradas para fijar la tira de conexión a tierra a la parte superior del depósito de metal.

Nunca utilice el baño con el circulador de inmersión retirado.

No monte el circulador de inmersión al revés; el cable de línea podría tocar el fluido del depósito.

Los baños de óxido de polifenileno (PPO) y acrílico transparentes solo se utilizan con agua.

Ajuste el software del baño para que se corresponda con el fluido utilizado.

## Instalación para circuladores de baño Arctic, Glacier y Sahara:

Asegúrese de que los cables eléctricos no tocan ninguna de las conexiones de tuberías o los tubos.

En el caso de baños refrigerados, instale el cable apantallado RJ45 suministrado entre el circulador de inmersión y los conectores RJ45 del baño (similar a Ethernet). Esto es necesario para un correcto funcionamiento.

En el caso de los baños refrigerados, instale el cable de alimentación desde el conector de la parte trasera del controlador, A, al conector de la parte trasera del baño refrigerado, B. Conecte el cable de alimentación del baño, C, a una toma de corriente conectada a tierra.

Con los baños refrigerados, nunca conecte la entrada de alimentación del controlador, A, a una toma de corriente. Nunca conecte la toma de corriente, B, a todo aquello que no sea un circulador de inmersión.

Para baños no refrigerados, conecte el cable de alimentación del baño, C, a una toma de corriente conectada a tierra.

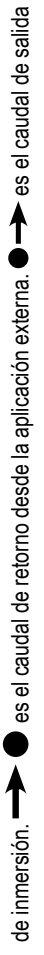
Las conexiones de las tuberías para circulación externa se encuentran en la parte posterior del circulador de inmersión.  es el caudal de salida a la aplicación externa (lado de suministro). Las conexiones tienen un diámetro exterior de 16 mm. Retire las placas y tuercas de unión para instalar las conexiones dentadas de 0,25 pulgadas, 0,5 pulgadas, 8 mm o 12 mm que se suministran con el circulador.

Para evitar que se produzcan daños en la fontanería del baño, utilice una llave inglesa fija de 19 mm para retirar o instalar las conexiones externas.

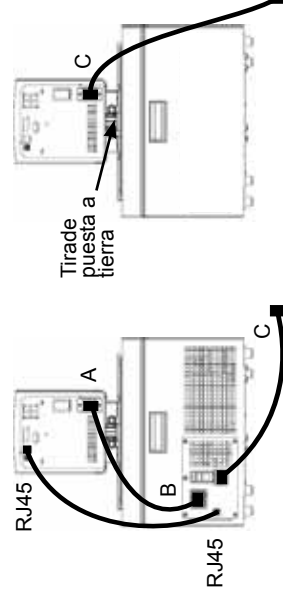

## Instruções Essenciais de Segurança Banhos Laboratoriais

**Não caso de não compreender qualquer uma destas instruções, consulte o manual ou contacte-nos antes de prosseguir.**

### Segurança, todos os produtos:

 Indica uma situação de perigo iminente que, se não for evitada, vai resultar em morte ou lesões graves.

 Indica uma situação de potencial perigo, que se não for evitada, pode resultar em morte ou lesões graves.

 Indica uma situação de potencial perigo, que se não for evitada, pode resultar em ferimentos leves ou moderados. Também é utilizado para alertar contra práticas não seguras.

 Destina-se a alertar o utilizador para a presença de "voltagem perigosa" sem isolamento na caixa da bomba de circulação. A magnitude da voltagem é suficientemente significativa para constituir um risco de choque eléctrico.

 Indica a presença de superfícies quentes.

 Indica a leitura do manual.

 Este rótulo indica que é utilizado um refrigerante inflamável.

Não utilize o dispositivo de banho como um dispositivo estéril ou ligado ao paciente. Em complemento, o dispositivo de banho não se destina a ser utilizado em Locais Perigosos de Classe I, II ou III conforme definido pelo Código Eléctrico Nacional.

Nunca coloque o dispositivo de banho num local ou atmosfera onde esteja presente calor excessivo, humidade ou materiais corrosivos. Consulte o manual de utilizador relativamente a parâmetros operacionais.

Deixe os dispositivos de banho refrigerados na posição vertical à temperatura ambiente (~25°C) durante 24 horas antes do arranque. Desta forma assegura que o óleo de lubrificação drene para o compressor. Ligue o equipamento a uma tomada de alimentação com ligação à terra.

O protector de circuito localizado na parte posterior do dispositivo não se destina a actuar como meio de desconexão.

Opere a bomba de circulação utilizando apenas o cabo da linha fornecido. Se o cabo de alimentação da bomba de circulação for utilizado como dispositivo de desconexão eléctrica, o mesmo deve ser facilmente acessível em todas as alturas.

Certifique-se de que os cabos eléctricos não entram em contacto com nenhuma das conexões de canalização ou tubagens.

Nunca aplique voltagem de linha a quaisquer das ligações de comunicação do dispositivo de banho. Certifique-se de que o tubo que selecciona cumpre os requisitos de temperatura e pressão máximos.

Certifique-se de que todas as conexões eléctricas e, se aplicável, de comunicação são realizadas antes do arranque.

Os refrigerantes utilizados são mais pesados do que o ar e, em caso de fuga, vão substituir o oxigénio causando perda de consciência. O contacto com o refrigerante em vazamento vai causar queimaduras na pele. Consulte a placa de identificação do circulador relativamente ao tipo de refrigerante utilizado e depois a Ficha de Segurança (SDS) dos EUA mais recente, anteriormente designada como MSDS, e a Ficha de Segurança da UE para informação adicional.

Certifique-se de que todas as portas de drenagem do reservatório estão fechadas e que todas as conexões de canalização são seguras. Certifique-se também de que qualquer resíduo é cuidadosamente removido antes do enchimento.

Para evitar derrame, coloque os seus recipientes no banho antes de encher.

Os fluidos à base de óleo expandem quando aquecidos. Evite o enchimento excessivo do reservatório.

Utilize apenas os fluidos aprovados listados no manual. A utilização de outros fluidos invalida a garantia. Nunca utilize glicol a 100%.

Quando utilizar água acima dos 80°C, acompanhe de perto o nível do fluido, pois serão necessárias reposições frequentes. Também gera vapor.

Mas misturas de água/glicol requerem reposições com água pura, caso contrário a percentagem de glicol vai aumentar resultando em elevada viscosidade e fraco desempenho.

Com exclusão da água, antes de utilizar qualquer fluido aprovado, ou quando realizar a manutenção onde o contacto com o fluido for provável, consulte as Fichas de Segurança SDS e EC do fabricante relativamente a precauções de manuseamento.

Certifique-se de que não são gerados gases tóxicos pelo fluido. Podem desenvolver-se gases inflamáveis sobre o fluido durante a utilização.

Quando utilizar etilenglicol e água, verifique a concentração do fluido e o pH regularmente. As alterações na concentração e no pH podem ter impacto no desempenho do sistema.

Certifique-se de que o ponto de corte do valor-limite da temperatura está definido abaixo do ponto de combustão para o fluido de transferência de calor seleccionado.

A temperatura operacional mais elevada, conforme definido pela NE 61010 (IEC 1010), deve estar limitada a 25°C abaixo do ponto de combustão do fluido do banho.

Certifique-se de que o fluido está a uma temperatura segura (abaixo dos 40°C) antes de manusear ou drenar.

Nunca opere equipamento danificado ou a vaziar, ou com cabos danificados.

Nunca opere o banho sem o fluido no reservatório.

Nunca opere o banho ou adicione fluido ao reservatório com os painéis removidos.

Não limpe o banho com solventes, utilize apenas um pano macio e água.

Drene o reservatório antes de o transportar e/ou armazenar, perto ou abaixo de temperaturas de congelamento.

Desactive sempre o banho e desligue a tensão de alimentação da fonte antes de deslocar ou realizar quaisquer procedimentos de revisão ou manutenção. As revisões e reparações devem ser efectuadas por um técnico qualificado.

Transporte o banho com cuidado. Solavancos ou quedas súbitas podem danificar os seus componentes.

O utilizador é responsável pela descontaminação se forem derramados materiais perigosos. Consulte o fabricante relativamente à descontaminação e ou à compatibilidade de agentes de limpeza.

Se o banho estiver para ser transportado e/ou armazenado a temperaturas baixas, é necessário realizar a drenagem e o enxaguamento com uma mistura de glicol/água de grau laboratorial 50/50.

O desmantelamento deve ser apenas efectuado por um representante qualificado utilizando equipamento certificado. Todos os regulamentos predominantes têm de ser seguidos.

Realizar procedimentos de instalação, operação ou manutenção para além dos descritos no manual pode resultar numa situação perigosa e invalida a garantia do fabricante.

Para os banhos Sahara e banhos de circulação de imersão independentes, utilize a porca e anilha fornecidas para fixar a faixa de ligação à terra ao topo do tanque de metal.

Nunca opere o banho com a bomba de circulação de imersão removida.

Não monete a bomba de circulação de imersão por trás; o cabo iria entrar em contacto com o fluido do reservatório.

Os Banhos de Acrílico Transparente e de óxido de Polifenileno (PPO) são utilizados apenas com água.

Ajuste o software fo banho de acordo com o fluido utilizado.

## Instalação das Bombas de Circulação de Banho Arctic, Glacier e Sahara:

Certifique-se de que os cabos eléctricos não entram em contacto com nenhuma das conexões de canalização ou tubagens.

Para os banhos refrigerados, instale o cabo protegido RJ45 fornecido entre a bomba de circulação de imersão e os conectores RJ45 (similar a Ethernet). Este procedimento é necessário para o funcionamento correcto.

Para os banhos refrigerados, instale o cabo de alimentação do controlador na parte posterior do controlador, A, para o conector na parte posterior do banho refrigerado, B. Ligue o cabo de alimentação do banho, C, a uma saída de alimentação com ligação à terra.

Para banhos refrigerados, nunca ligue entradas de alimentação de controlador, A, a uma saída de alimentação. Nunca ligue saídas de alimentação, B, a nada excepto uma bomba de circulação de imersão. Para banhos não refrigerados, ligue o cabo de alimentação do banho, C, a uma saída de alimentação com ligação à terra.

As ligações de canalização para circulação externa estão localizadas na parte posterior da bomba de circulação de imersão. → é o fluxo de retorno da aplicação externa. ● é o fluxo de saída para a aplicação externa (lado de abastecimento). As conexões são O.D. 16 mm. Remova as porcas de união e placas para instalar as espigas de tubos 8 mm ou 12 mm e grampos fornecidos com a bomba de circulação.

Para evitar danos na tubagem da bomba de circulação, utilize uma chave de apoio de 19 mm quando remover/instalar as ligações externas.

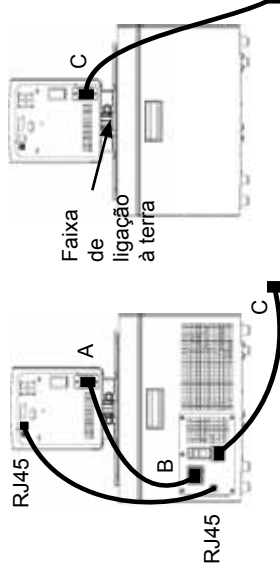



# Essentiële veiligheidsinstructies

## Baden voor laboratoria

Als één van de instructies niet duidelijk is, raadpleeg dan de handleiding of neem contact op met ons vooraleer door te gaan.

### Veiligheid, alle producten:

 duidt op een onmiddellijke gevaarlijke situatie die, indien ze niet wordt vermeden, zal leiden tot de dood of ernstige letsels.

 duidt op een gevaarlijke situatie die, indien ze niet wordt vermeden, kan leiden tot de dood of ernstige letsels.

 duidt op een mogelijke gevaarlijke situatie die, indien ze niet wordt vermeden, zal leiden tot lichte of middelmatige letsels. Het kan ook gebruikt worden als waarschuwing tegen onveilige praktijken.

 bedoeld om de gebruiker te waarschuwen voor de aanwezigheid van een niet-geïsoleerde "gevaarlijke spanning" binnenin de behuizing van de circulatiepomp. De grootte van de spanning is voldoende significant om een gevaar te vormen op een elektrisch schok.

 duidt op de aanwezigheid van hete oppervlakken.

 duidt op het raadplegen van de handleiding.

 Dit etiket geeft aan dat een ontvlambaar koelmiddel wordt gebruikt.

Gebruik het bad niet als steriel of als een met de patiënt verbonden apparaat. Daarnaast is het bad niet ontworpen voor gebruik in gevaarlijke situaties van klasse I, II of III zoals gedefinieerd door de National Electrical Code.

Plaats deze nooit op een locatie met overmatige hitte, vochtigheid, onvoldoende ventilatie of waar er corrosieve materialen aanwezig zijn. Raadpleeg de gebruikershandleiding voor de operationele parameters. Laat de gekoelde baden gedurende 24 uur in een rechtopstaande positie staan bij kamertemperatuur (~25°C) vooraleer deze te starten. Dit verzekert dat de smeerolie terug in de compressor is gelopen. Sluit het bad steeds aan op een goed geaard stopcontact.

De circuitbeveiliging bevindt zich aan de achterzijde van het bad en is niet bedoeld als middel om het los te koppelen.

Laat de circulatiepomp alleen functioneren met het meegeleverde netsnoer. Het netsnoer van de circulatiepomp wordt gebruikt om het apparaat los te koppelen en dit moet te allen tijde goed bereikbaar zijn. Verzekert dat de netsnoeren niet in contact komen met de leidingaansluitingen of slangen.

Sluit nooit de netspanning aan op de communicatie-aansluitingen van het bad.

Verzekert dat de slangen die u selecteert bestand zijn tegen de maximale temperatuur- en drukvereisten.

Verzekert dat alle elektrische en, indien van toepassing, communicatie-aansluitingen goed zijn aangesloten vooraleer te starten.

Koelmiddelen zijn zwaarder dan lucht en als er een lek is, zal het de zuurstof vervangen en kan dit leiden tot bewusteloosheid. Contact met het lekkende koelmiddel kan leiden tot brandwonden op de huid.

Raadpleeg het typeplaatje van de circulatiepomp voor het type koelmiddel dat wordt gebruikt en raadpleeg vervolgens het meest recente veiligheidsgegevensblad (Safety Data Sheet - SDS) van de producent, eerder gekend als MSDS, en het Europese veiligheidsgegevensblad voor extra informatie.

Zorg ervoor dat de afvoerpoorten van het reservoir zijn gesloten en dat alle leidingaansluitingen goed zijn afgedicht. Verzekert ook dat alle residuen grondig zijn verwijderd voorafgaand aan het vullen.

Om het morsen tegen te gaan, plaatst u uw containers in het bad vooraleer ze te vullen.

Op olie-gebaseerde vloeistoffen zetten uit wanneer ze worden opgewamd. Vermijd het overvullen van het reservoir.

Maak alleen gebruik van de goedgekeurde vloeistoffen in de handleiding. Het gebruik van andere vloeistoffen zal de garantie doen vervallen. Gebruik nooit 100% glycol.

Bij het gebruik van water dat warmer is dan 80°C moet u het vloeistofniveau goed in de gaten houden en zal u regelmatig vloeistof moeten bijvullen. Het creëert ook stoom.

Mengelingen van water en glycol vereisen regelmatig dat het water wordt bijgevuld, anders zal het percentage glycol leiden tot een verhoogde viscositeit en slechte prestaties.

Vooraleer een goedgekeurde vloeistof, dus geen water, te gebruiken of onderhouden uit te voeren waarbij het waarschijnlijk is dat in aanraking komt met de vloeistof, raadpleegt u het meest recente veiligheidsgegevensblad (Safety Data Sheet - SDS) van de leverancier en het Europese veiligheidsgegevensblad voor voorzorgsmaatregelen om ermee om te gaan.

Verzekert dat er geen giftige gassen kunnen worden gegenereerd door de vloeistof. Er kunnen zich dan ontvlambare gassen opbouwen boven de vloeistof tijdens het gebruik.

Bij het gebruik van ethyleenglycol en water moet u de vloeistofconcentratie en pH op een regelmatige basis controleren. Wijzigingen in de concentratie en de pH kunnen een impact hebben op de prestaties van het systeem.

Verzekert dat het "cut-off"-punt van een te hoge temperatuur lager wordt gezet dan het ontstekingspunt voor de warmte-overdracht van de geselecteerde vloeistof.

De hoogste werkt temperatuur, zoals gedefinieerd door de EN 61010 (IEC 1010), moet beperkt worden tot 25°C graden onder het ontstekingspunt voor de vloeistof van het bad.

Verzekert dat de vloeistof een veilige temperatuur heeft (lager dan 40°C) vooraleer deze te hanteren of deze af te laten.

Gebruik nooit beschadigde of lekkende apparatuur, of apparatuur waarvan het netsnoer is beschadigd.

Stel het bad nooit in werking zonder dat er zich vloeistof in het reservoir bevindt.

Stel het bad nooit in werking of voeg geen vloeistof toe aan het reservoir wanneer de panelen zijn verwijderd.

Reinig het bad niet met solventen maar gebruik een zachte doek en water.

Laat het reservoir leeglopen voor het transporteren en/of opslag bij temperaturen nabij of onder het vriespunt.

Schakel het bad steeds uit en koppel het netsnoer los vooraleer service- of onderhoudsprocedures uit te voeren. Laat het onderhoud en de herstellingen steeds uitvoeren door een gekwalificeerd technicus.

Transporteer het bad steeds erg zorgvuldig. Plote schokken of druppels kunnen de componenten beschadigen.

De gebruiker is verantwoordelijk voor de ontsmetting als er gevaarlijke materialen worden gemorst. Neem contact op met de producent betreffende de verontreiniging en/of de compatibiliteit van de reinigingsmiddelen.

Als het bad moet worden getransporteerd en/of moet worden opgeslagen in koude temperaturen moet het eerst volledig leeg worden gelaten en vervolgens worden gespoeld met een 50/50 glycol/watermengeling van laboratoriumkwaliteit.

Het buiten dienst stellen mag alleen uitgevoerd worden door een gekwalificeerde dealer die gebruik maakt van gecertificeerde uitrusting. Alle geldende regelgevingen moeten worden gevolgd.

Het uitvoeren van de installatie-, de werkings- of onderhoudsprocedures op een andere manier dan beschreven in de handleiding kunnen leiden tot een gevaarlijke situatie en zullen de garantie van de producent ongeldig maken.

Gebruik voor Sahara-baden en alleenstaande dompelcirculatiepompen de meegeleverde bout en moer om de aardingsband aan de bovenzijde van de metalen tank te bevestigen.

Laat het bad nooit functioneren als de dompelcirculatiepomp is verwijderd.

Monteer de dompelcirculatiepomp nooit achterstevoren omdat het netsnoer kan in contact komen met de vloeistof in het reservoir.

Transparante acryl- en polyfyleenoxide baden mogen alleen met water worden gebruikt.

Pas de software van het bad aan zodat deze overeenkomt met de gebruikte vloeistof.

## Installatie van Arctic-, Glacier- en Sahara-badcirculatiepompen:

Verzeker dat de netsnoeren niet in contact komen met de leidingaansluitingen of slangen.

Installeer voor gekoelde baden de meegeleverde afgeschermde RJ45-kabel tussen de dompelcirculatiepomp en de RJ45-aansluitingen op het bad (geelkleurig aan ethernet). Dit is nodig voor een correcte werking.

Sluit voor gekoelde baden het netsnoer van de aansluiting op de achterzijde van controller A aan op de aansluiting van de achterzijde van het gekoelde bad B. Sluit het netsnoer van bad C aan op een geaard stopcontact.

Sluit voor gekoelde baden de stroomingang van controller A nooit aan op een stopcontact. Sluit de stroomuitgang B nooit op iets anders aan dan een dompelcirculatiepomp.

Sluit voor niet-gekoelde baden het netsnoer van bad C aan op een geaard stopcontact.

De leidingaansluitingen voor de externe circulatie bevinden zich aan de achterzijde van de dompelcirculatiepomp. → is de retourstroom van de externe toepassing. ● → is de afvoerstroom naar de externe applicatie (toevoerzijde). De aansluitingen zijn 16 mm. Verwijder de eenheidsmoeren en platen om de met de circulatiepomp meegeleverde klemmen en buiskoppelingen van 8 mm of 12 mm te installeren.

Om schade te voorkomen aan de leidingen van de circulatiepomp gebruikt u een moersleutel van 19 mm bij het losmaken/installeren van de aansluitingen.

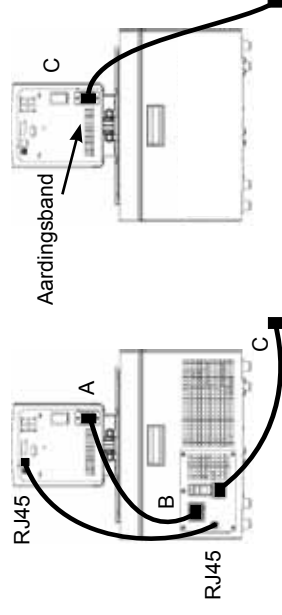



## Istruzioni essenziali per la sicurezza

### Bagni da laboratorio

Se queste istruzioni non sono chiare, fare riferimento al manuale oppure contattare il nostro ufficio prima di procedere.

#### Sicurezza, tutti i prodotti:

 indica una situazione di pericolo imminente che, se non evitata, potrebbe causare morte o ferite gravi.

 indica una situazione potenzialmente pericolosa che se non evitata potrebbe causare lesioni gravi o morte.

 indica una situazione di pericolo potenziale che, se non evitata, potrebbe causare ferite lievi o non gravi. Viene anche utilizzato come avviso contro pratiche non sicure.

 destinato ad avvisare l'utente della presenza di "tensioni pericolose" non isolate all'interno dell'involucro del sistema di circolazione. Il valore della tensione è abbastanza significativo da costituire un rischio di scosse elettriche.

 indica la presenza di superfici calde.

 segnala di leggere il manuale.

 Questa etichetta indica che è stato utilizzato un refrigerante infiammabile.

Non utilizzare il bagno come dispositivo sterile o collegato a un paziente. Inoltre, il bagno non è progettato per l'utilizzo in luoghi pericolosi di Classe I, II o III secondo le definizioni del National Electrical Code.

Non collocare mai il bagno in luoghi o atmosfere soggetti a calore eccessivo, umidità o materiali corrosivi. Fare riferimento al manuale dell'utente per i parametri operativi.

Lasciare i bagni refrigerati in posizione verticale a temperatura ambiente (~25°C) per 24 prima dell'avviamento. Ciò garantirà il ritorno dell'olio di lubrificazione nel compressore.

Collegare il bagno ad una presa di rete adeguatamente messa a terra.

Il sistema di protezione circuito sul retro del bagno non è progettato per operare come sistema di disconnessione.

Azionare il circolatore solo tramite il cavo di linea in dotazione. Se il cavo di alimentazione del circolatore viene utilizzato come sistema di disconnessione elettrica, deve essere sempre facilmente accessibile.

Assicurarsi che i cavi elettrici non entrino in contatto con tubazioni o loro raccordi.

Non applicare mai la tensione di linea alle connessioni di comunicazione del bagno.

Assicurarsi che la tubazione selezionata soddisfi i requisiti di temperatura e pressione massimi.

Assicurarsi che prima dell'avviamento vengano realizzate tutte le connessioni elettriche e, se previste, di comunicazione.

I refrigeranti utilizzati sono più pesanti dell'aria e, in caso di perdite, possono sostituire l'ossigeno causando perdita di conoscenza. Il contatto della pelle con il refrigerante fuoriuscito causa ustioni. Per ulteriori informazioni, fare riferimento alla targhetta del circuito circolatore per il tipo di refrigerante utilizzato e ai dati tecnici di sicurezza aggiornati del produttore (US Safety Data Sheet - SDS), precedentemente noti come MSDS, nonché ai dati tecnici di sicurezza UE.

Assicurarsi che eventuali porte di scarico del serbatoio siano chiuse e che tutte le connessioni delle tubazioni siano sicure. Verificare anche che eventuali residui vengano rimossi completamente prima di procedere al riempimento.

Per evitare gocciolamenti, collocare i contenitori nel bagno prima di eseguire il riempimento.

I fluidi a base di olio si espandono quando vengono riscaldati. Evitare di riempire eccessivamente il serbatoio.

Utilizzare esclusivamente i fluidi certificati elencati nel manuale. L'utilizzo di altri fluidi annulla la garanzia. Non utilizzare mai glicole al 100%.

Quando si utilizza acqua ad una temperatura superiore a 80°C, monitorare attentamente il livello del fluido, in quanto potrebbe essere necessario eseguire dei rabbocchi frequenti. In tali condizioni si crea anche del vapore.

Le miscele acqua/glicole richiedono rabbocchi con acqua pura, altrimenti la percentuale di glicole aumenterà, con la conseguenza di una maggiore viscosità e prestazioni insoddisfacenti.

Oltre all'acqua, prima di utilizzare altri fluidi approvati, o quando si eseguono operazioni di manutenzione nelle quali potrebbe verificarsi il contatto con il fluido, fare riferimento ai fogli tecnici di sicurezza SDS e EC del produttore per le precauzioni da adottare.

Assicurarsi che il fluido non generi gas tossici. I gas infiammabili possono accumularsi sul fluido durante l'utilizzo.

Se si utilizza glicole di etilene ed acqua, controllare periodicamente la concentrazione del fluido e il pH. Variazioni di concentrazione e pH possono compromettere le prestazioni del sistema.

Assicurarsi che il punto di esclusione della sovra-temperatura sia impostato ad un valore più basso del punto di accensione per il fluido di trasferimento calore selezionato.

La temperatura massima operativa, in base alle definizioni della norma EN 61010 (IEC 1010), deve essere limitata a 25°C sotto il punto di accensione del fluido del bagno.

Assicurarsi che il fluido si trovi ad una temperatura di sicurezza (sotto i 40°C) prima di maneggiarlo o scaricarlo.

Non azionare mai apparecchi danneggiati, che presentano perdite, o con cavi danneggiati.

Non azionare mai il bagno senza liquido nel serbatoio.

Non azionare mai il bagno o aggiungere fluidi al serbatoio con i pannelli rimossi.

Non pulire il bagno con solventi, utilizzare esclusivamente un panno morbido e acqua.

Scaricare il serbatoio prima che venga trasportato e/o stoccato in prossimità o sotto la temperatura di congelamento.

Spegner sempre il bagno e scollegare la tensione di alimentazione dalla fonte di alimentazione prima di ogni spostamento e prima di eseguire operazioni di manutenzione. Demandare assistenza e riparazioni ad un tecnico qualificato.

Spostare il bagno con cautela. Sobbalzi o cadute improvvise possono danneggiare i suoi componenti.

L'utente è responsabile della decontaminazione in caso di gocciolamenti di materiale pericoloso.

Consultare il produttore in relazione alla decontaminazione e/o alla compatibilità con agenti detergenti.

Se è necessario trasportare il bagno o stoccarlo in condizioni di bassa temperatura, l'apparecchio andrà scaricato e risciacquato con una miscela 50/50 di glicole/acqua a gradazione da laboratorio.

La disattivazione deve essere eseguita solo da rivenditori qualificati utilizzando attrezzature certificate. Dovranno essere rispettate tutte le norme vigenti.

L'esecuzione di procedure di installazione, funzionamento o manutenzione diverse da quelle descritte nel manuale potrebbero determinare situazioni di pericolo e causare l'annullamento della garanzia del produttore.

Per i bagni Sahara e i circolatori ad immersione indipendenti, utilizzare il dado e la rondella in dotazione per fissare la striscia di messa a terra sulla parte superiore del serbatoio metallico.

Non azionare mai il bagno senza il circolatore ad immersione.

Non montare il circolatore ad immersione al contrario; il cavo di linea potrebbe entrare in contatto con il fluido del serbatoio.

I bagni di ossido di polifenilene (PPO) e acrilico trasparente vengono utilizzati solo con acqua.

Impostare il software del bagno in base al fluido utilizzato.

## Installazione per i circolatori bagni Arctic, Glacier e Sahara:

Assicurarsi che i cavi elettrici non entrino in contatto con tubazioni o loro raccordi.

Per i bagni refrigerati, installare il cavo schermato RJ45 in dotazione tra il circolatore ad immersione e i connettori RJ45 (analoghi ai connettori Ethernet) del bagno. Ciò è necessario per un corretto funzionamento.

Per i bagni refrigerati, installare il cavo di alimentazione dal connettore sul retro del controller, A, al connettore sul retro del bagno refrigerato, B. Collegare il cavo di alimentazione del bagno, C, ad una presa di alimentazione messa a terra.

Per i bagni refrigerati, non collegare mai l'ingresso di alimentazione del controller, A, ad una presa di alimentazione. L'uscita di alimentazione, B, va collegata esclusivamente ad un circolatore ad immersione.

Per i bagni non refrigerati, collegare il cavo di alimentazione del bagno, C, ad una presa di alimentazione messa a terra.

Le connessioni delle tubazioni per la circolazione esterna si trovano sul retro del circolatore ad immersione.

➔ ● è il flusso di ritorno dall'applicazione esterna. ● ➔ è il flusso in uscita verso l'applicazione esterna (lato alimentazione). Le connessioni sono O.D. da 16 mm. Togliere le piastre e i dadi di unione per installare le spine tubi e i morsetti da 8 mm o 12 mm forniti con il circolatore.

Per evitare danni alle tubazioni del circolatore, utilizzare una chiave da 19 mm quando si rimuovono/ installano le connessioni.

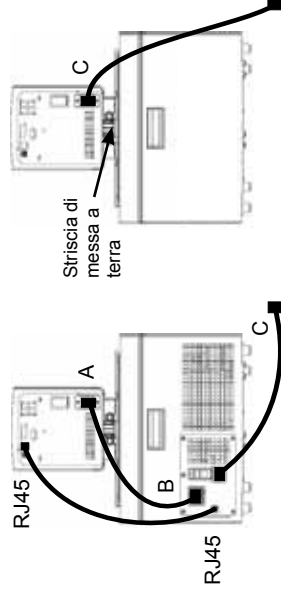





## Важни инструкции за безопасност Лабораторни вани

Ако някоя от тези инструкции не бъде разбрана, се обрънете към ръководството или се свържете с нас, преди да продължите.

### Безопасност, всички продукти:

 **DANGER** указва непосредствено опасна ситуация, която, ако не бъде избегната, ще доведе до смърт или тежка телесна повреда.

 **WARNING** указва потенциално опасна ситуация, която, ако не бъде избегната, може да доведе до смърт или тежка телесна повреда.

 **CAUTION** указва потенциално опасна ситуация, която, ако не бъде избегната, може да доведе до лека или средна телесна повреда. Също така се използва, за да предупреди за опасни практики.

 предназначен да предупреди потребителя за наличие на неизоллирано "опасно напрежение" в рамките на корпуса на циркулатора. Величината на напрежението е достатъчно значима, за да поражда риск от електрически удар.

 указва наличието на горещи повърхности.

 указва, че ръководството трябва да се прочете.

 Този етикет показва, че се използва запалим хладилен агент.

Не използвайте ваната като стерилно устройство или устройство, свързано с пациенти. В допълнение ваната не е предназначена за употреба в клас I, II или III опасни места, както е определено от Националния закон за електричеството на САЩ (NEC).

Никога не поставяйте ваната на място или в атмосфера, където има висока температура, влажност или корозивни материали. Вижте ръководството за потребителя за експлоатационните параметри. Оставете охладените вани в изправено положение при стайна температура (~25°C) в продължение на 24 часа, преди да ги стартирате. Това гарантира, че смазочното масло се отцежда обратно в компресора.

Свържете ваната към правилно заземен контакт.

Предпазителят за веригата, разположен на задната част на ваната, не е предназначен да действа като средство за изключване.

Работете с циркулатора, използвайки само предоставения кабел. Ако защитният кабел на циркулатора се използва като устройство за изключване, той трябва да е лесно достъпен по всяко време.

Уверете се, че електрическите кабели не са в контакт с която и да било от водопроводните връзки или тръби.

Никога да не се прилага линейно напрежение към която и да било от комуникационните връзки на ваната.

Уверете се, че тръбите, които изберете, отговарят на изискванията за максимална температура и налягане.

Уверете се, че всички електрически и, ако е приложимо, комуникационни връзки са направени, преди да стартирате.

Използваните хладилни агенти са по-тежки от въздуха и, ако има теч, те ще заменят кислорода, причинявайки загуба на съзнание. Контактът с изтичащ хладилен агент ще предизвика изгаряния на кожата. Направете справка с фирмената табела на циркулатора за типа на използвания хладилен агент, след което към най-актуалния информационен лист за безопасност на САЩ (SDS) от производителя, известен преди като MSDS, и също така и към информационния лист за безопасност на ЕС, за допълнителна информация.

Уверете се, че всички портове за източване на резервоара са затворени и че всички водопроводни връзки са фиксирани. Също така се уверете, че всички остатъци са напълно отстранени, преди да напълните.

За да се избегне разливане, поставете контейнерите във ваната, преди да напълните.

Течностите на маслена основа се разширяват при загряване. Избягвайте претъпяването на резервоара.

Използвайте само одобрените течности, посочени в ръководството. Използването на други течности ще анулира гаранцията. Никога не използвайте 100% глицол.

При използване на вода над 80°C следете отблизо нивото на течността, ще се налагат чести допълвания. Също така се отделя пара.

Водните/глицолните смеси изискват допълвания с чиста вода; в противен случай процентът на глицол ще се увеличи, което ще доведе до висок вискозитет и слаба производителност.

Освен когато ползвате вода, преди да използвате каквато и да било одобрена течност или когато извършвате дейности по поддръжка, където е възможен контакт с течността, направете справка с SDS от производителя и информационния лист за безопасност на ЕС за предпазни мерки при работа.

Уверете се, че течността не може да генерира токсични газове. Запалими газове могат да се натрупат над течността по време на употреба.

При използване на етилен глицол и вода проверявайте редовно концентрацията на течността и pH. Промените в концентрацията и pH могат да окажат влияние върху производителността на системата.

Уверете се, че точката на прекъсване за превишена температура е заложена да е по-ниска от точката на запалване за пренасящата топлина течност, която сте избрали.

Най-високата работна температура, както е определено от EN 61010 (IEC 1010), трябва да бъде ограничена до 25°C под точката на запалване на течността във ваната.

Уверете се, че течността е с безопасна температура (под 40°C), преди да боравите с нея или да я източвате.

Никога не експлоатирайте повредено оборудване или оборудване с течове, както и такова с повредени кабели.

Никога не експлоатирайте ваната без охлаждаща течност в резервоара.

Никога не експлоатирайте ваната или не добавяйте течност към резервоара, докато има отстранени панели.

Не почиствайте ваната с разтворители, използвайте мека кърпа и вода.

Източете резервоара, преди да го транспортирате и/или да го съхранявате при близки до или под нулата температури.

Винаги изключвайте ваната и изваждайте щепсела на захранващото напрежение от източника на захранването, преди да премествате или преди да извършвате каквито и да било процедури по обслужване или поддръжка. За обслужване и ремонтни дейности се обрънете към квалифициран техник.

Транспортирайте ваната внимателно. Внезапни сътресения или изпускания могат да повредят компонентите му.

Потребителят е отговорен за деконтаминацията, ако бъдат разкрити опасни материали. Консултирайте се с производителя относно деконтаминацията и/или съвместимостта на почистващите агенти.

Ако ваната трябва да се транспортира и/или да се съхранява при ниски температури, тя трябва да бъде източена и след това промита със смес от 50/50 лабораторен клас гликол/вода.

Извеждането от експлоатация трябва да се извършва само от квалифициран дилър, като се използва сертифицирано оборудване. Всички действащи разпоредби трябва да се спазват.

Извършване на монтаж, експлоатация или процедури за поддръжка, различни от тези, описани в ръководството, може да доведе до опасна ситуация и анулира гаранцията на производителя.

За ваните Sahara и за самостоятелните потопяеми циркулатори използвайте приложените гайка и шайба за фиксиране на каишката за заземяване към върха на металния резервоар.

Никога не експлоатирайте ваната, когато потопяемият циркулатор е премахнат.

Не монтирайте потопяемия циркулатор назад; захранващият кабел може да влезе в контакт с течността в резервоара.

Прозрачните акрилни вани и тези от полипропилен оксид се използват само с вода.

Регулирайте софтуера на ваната, за да е в съответствие с използваната течност.

## Монтаж за циркуляционни вани Arctic, Glacier и Sahara:

Уверете се, че електрическите кабели не влизат в контакт с коята и да било от водопроводните връзки или тръби.

За охладени вани монтирайте предоставения RJ45 екраниран кабел между потопяемия циркулатор и RJ45 конекторите на ваната (подобно на Ethernet). Това е необходимо за правилното функциониране.

За охладени вани монтирайте захранващия кабел от конектора на задния панел на контролера (A) към конектора на гърба на охладената вана (B). Свържете захранващия кабел на ваната (C) към заземен контакт.

За охладени вани никога не свързвайте входа за захранване на контролера (A) към електрически контакт. Никога не свързвайте изхода за захранване (B) към нещо друго освен към потопяемия циркулатор

За неохладени вани свържете захранващия кабел на ваната (C) към заземен контакт.

Водопроводните връзки за външна циркулация са разположени в задната част на потопяемия циркулатор. → ● е връщаният поток от външното приложение. ● → е изходящият поток към външното приложение (подаващата страна). Връзките са с 16 мм външен диаметър. Премахнете съединителните гайки и пластини, за да монтирате скобите и щучерите за маркуч от 8 мм или 12 мм, предоставени с циркулатора.

За да се предотврати повреда на тръбопровода на циркулатора, използвайте 19 мм поддържащ гаечен ключ, когато отстранявате/монтирате връзките.

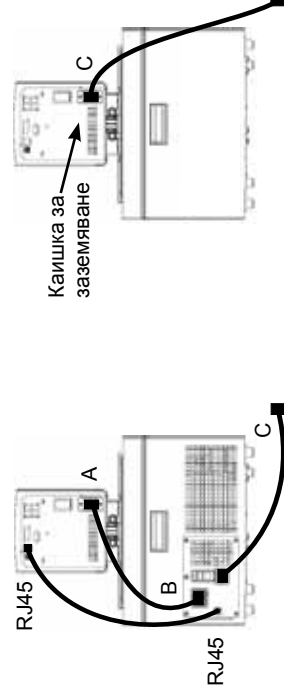

## Základní bezpečnostní pokyny Laboratorní lázně

Pokud některým z těchto pokynů nebudete rozumět, nahlédněte před pokračováním do návodu k obsluze nebo nás kontaktujte.

### Bezpečnost, všechny produkty:



Značí bezprostředně nebezpečnou situaci, která pokud nebude odstraněna, povede ke smrtelnému nebo závažnému úrazu.



Značí potenciálně nebezpečnou situaci, která pokud nebude odstraněna, může vést ke smrtelnému nebo závažnému úrazu.



Značí potenciálně nebezpečnou situaci, která pokud nebude odstraněna, může vést k méně až středně závažnému úrazu. Slouží také jako výstraha před nebezpečnými postupy.



Slouží k upozornění uživatele na přítomnost neizolovaného „nebezpečného napětí“ v krytu cirkulačního termostatu. Napětí je dostatečně vysoké na to, aby představovalo riziko úrazu elektrickým proudem.



Značí přítomnost horkých povrchů.



Značí, že si má obsluha přečíst návod k obsluze.



Tento štítek označuje, že se používá hořlavé chladivo.

Lázeň nepoužívejte jako sterilní zařízení nebo zařízení připojené k pacientovi. Lázeň navíc není určena k používání v rizikových lokalitách třídy I, II nebo III podle národních elektrotechnických předpisů.

Lázeň nikdy neumisťujte do míst nebo prostředí s nadměrnou teplotou či vlhkostí nebo do prostředí, kde jsou přítomné korozivní materiály. Provozní parametry jsou uvedené v návodu k obsluze.

Než začnete, nechte chlazené lázně 24 hodin stát ve vzpřímené poloze při pokojové teplotě (přibl. 25 °C).

Tím zajistíte, že se lubrikační olej vypustí zpátky do kompresoru.

Připojte lázeň k řádně uzemněné zásuvce.

Jistič umístěný na zadní straně lázně není určen k tomu, aby sloužil jako odpojovač.

Cirkulační termostat smí být napájen pouze pomocí dodaného kabelu. Pokud je napájecí kabel cirkulačního termostatu použit jako odpojovací zařízení, musí být neustále přístupný.

Elektrické kabely nesmí přijít do kontaktu s žádnými připojovacími armaturami nebo hadicemi.

Nikdy nepřivádějte elektrické napětí k žádným komunikačním konektorům lázně.

Vámi zvolené potrubí a hadice musí vyhovovat vašim požadavkům na maximální teplotu a tlak.

Před spuštěním zařízení připojte veškerá elektrická a komunikační vedení.

Použitá chladiva jsou těžší než vzduch a pokud dojde k jejich úniku, vytačte veškerý vzduch a způsobí ztrátu vědomí. Kontakt s unikajícím chladivem způsobí popálení pokožky. Typ použitého chladiva zjistíte na štítku s technickými údaji cirkulačního termostatu a další informace jsou uvedeny v aktuálním bezpečnostním listu výrobce.

Přesvědčte se, že jsou zavřené všechny vypouštěcí otvory nádržky, a že jsou bezpečně zajištěné všechny připojovací armatury. Před naplněním taky zajistíte, aby byly odstraněny všechny usazeniny.

Abyste předešli rozliti, umístěte nádoby do lázně ještě před naplněním.

Kapaliny na bázi oleje při zahřátí nabývají na objemu. Nádržku nepřetěžujte.

Používejte pouze schválené kapaliny uvedené v návodu k obsluze. Použití jiných kapalin způsobí zneplátnění záruky. Nikdy nepoužívejte 100% glykol.

Při používání vody s teplotou nad 80 °C pozorně sledujte hladinu kapaliny, neboť bude potřeba časté doplňování. Dochází také k vytváření páry.

Směsi vody a glykolu vyžadují doplňování čistou vodou. V opačném případě by vzrostla koncentrace glykolu, což by vedlo k vysoké viskozitě a špatnému výkonu.

Před používáním jiné schválené kapaliny než vody nebo při provádění údržby s možným kontaktem s kapalinou si přečtěte pokyny k manipulaci v bezpečnostním listu výrobce.

Zajistěte, aby se z kapaliny nevypařovaly žádné toxické plyny. Při používání se nad kapalinou mohou hromadit hořlavé plyny.

Při používání etylenglykolu a vody pravidelně kontrolujte koncentraci a pH kapaliny. Změny koncentrace a pH mohou mít vliv na výkon systému.

Zajistěte, aby byl horní limit teploty nastaven níže, než je teplota vznícení zvolené kapaliny pro přenos tepla.

Nejvyšší pracovní teplota, stanovená podle normy EN 61010 (IEC 1010), musí být o 25 °C nižší než teplota hoření kapaliny v lázni.

Před manipulací nebo vypouštěním se přesvědčte, že má kapalina bezpečnou teplotu (nižší než 40 °C).

Nikdy nepoužívejte poškozené nebo netěsné zařízení nebo zařízení s poškozenými kabely.

Lázeň nikdy nepoužívejte, pokud v nádržce není žádná kapalina.

Lázeň nikdy nepoužívejte nebo do ní nepřidávejte kapalinu, když jsou demontované panely.

Neuštěte lázeň pomocí rozpouštědel, použijte měkký hadřík a vodu.

Před transportem a před uskladněním při teplotách okolo bodu mrazu nádržku vypustěte.

Před přesunem nebo prováděním servisu či údržby lázeň vždy vypněte a odpojte napájení. Servis a opravy přenechejte kvalifikovaným servisním technikům.

Při přenášení lázně buďte opatrní. Náhlé nárazy nebo pády mohou poškodit její součásti.

Pokud dojde k rozliti nebezpečných materiálů, musí uživatel zajistit dekontaminaci. Informace o dekontaminaci a o kompatibilitě čistících prostředků získáte u výrobce.

Pokud se má lázeň přesunout nebo uskladnit při nízkých teplotách, musí být vypuštěna a vypláchnuta směsí glykolu v laboratorní kvalitě a vody v poměru 1:1.

Výřazení z provozu smí provádět pouze kvalifikovaný prodejce s pomocí certifikovaného vybavení. Musí být dodržena veškerá platná nařízení.

Provádění jiných postupů při instalaci, obsluze nebo údržbě, než které jsou popsány v návodu k obsluze, může vést k nebezpečným situacím a způsobit zneplatnění záruky výrobce.

V případě lázni Sahara a samostatných ponorných cirkulačních termostátů připevněte pomocí dodané matky a podložky zemnicí pásek k horní části kovové nádržky.

Lázeň nikdy nepoužívejte, když je odstraněn ponorný cirkulační termostát.

Nepřipevňujte ponorný cirkulační termostát dozadu, kabel by mohl přijít do kontaktu s kapalinou v nádržce.

Lázně z transparentního akrylu a polyfenylen oxidu se používají pouze s vodou.

Upravte software lázně tak, aby vyhovoval použité kapalině.

## Instalace cirkulačních lázní Arctic, Glacier a Sahara:

Elektrické kabely nesmí přijít do kontaktu s žádnými přípojovacími armaturami nebo hadicemi.

V případě chlazených lázní propojte dodávaným stíněným kabelem RJ45 konektory RJ45 na ponorném cirkulačním termostatu a na lázni (jsou podobné ethernetovým konektorům). Je to potřeba pro správné fungování.

V případě chlazených lázní zapojte napájecí šňůru do konektoru na zadní straně ovládacího panelu A a do konektoru na zadní straně chlazené lázně B. Zapojte napájecí šňůru lázně C do uzemněné zásuvky.

V případě chlazených lázní nikdy nepřipojujte napájecí konektor na ovládacím panelu A k elektrické zásuvce. Nikdy nepřipojujte elektrickou zásuvku B k ničemu jinému než ponornému cirkulačnímu termostatu.

V případě nechlazených lázní připojte napájecí šňůru lázně C k uzemněné zásuvce.

Přípojovací armatury pro externí cirkulaci jsou umístěné na zadní části ponorného cirkulačního termostatu. **→** je vratný tok z externího zařízení. **●** je výstupní tok do externího zařízení (přívodní strana).

Přípojky mají vnější průměr 16 mm. Demontujte spojovací matky a desičky, abyste mohli nainstalovat 8mm nebo 12mm ostatné hadicové armatury a spojky dodávané s cirkulačním termostatem.

Aby nemohlo dojít k poškození potrubí cirkulačního termostatu, používejte při demontáži nebo instalaci přípojek 19mm kontra klíč.

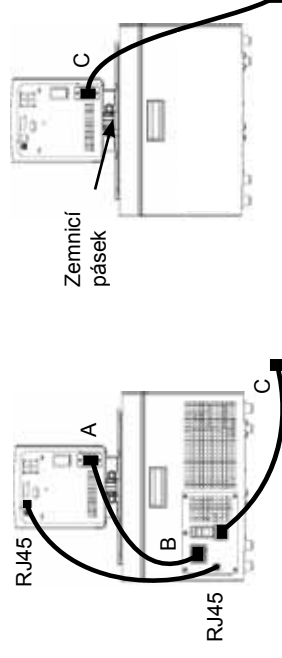



# Essentielle sikkerhedsinstruktioner

## Laboratoriebade

Hvis nogen af disse instrukser ikke kan forstås, så referer til manualen eller kontakt os, før du fortsætter.

### Sikkerhed, alle produkter:

**DANGER** indikerer en omgående farlig situation som, hvis den ikke undgås, vil resultere i død eller alvorlig skade.

**WARNING** indikerer en potentielt farlig situation som, hvis den ikke undgås, kunne resultere i død eller alvorlig skade.

**CAUTION** indikerer en potentielt farlig situation som, hvis den ikke undgås, kunne resultere i mindre eller moderat skade. Det bruges også til at alarmere mod usikker praksis.

 beregnet til at alarmere brugeren om tilstedeværelsen af ikke-isoleret "farlig spænding" inden for cirkulatorens indelukke. Omfanget af spændingen er betydelig nok til at udgøre en risiko for elektrisk stød.

 indikerer tilstedeværelse af varme overflader.

 indikerer, at du skal læse håndbogen.

 Denne etiket angiver, at der anvendes et brandfarligt kølemiddel.

Brug ikke badet som en steril eller patientforbundet enhed. Derudover er badet ikke designet til brug i klasse I, II eller III farlige steder som defineret af National Electrical Code.

Placer aldrig badet i et sted eller atmosfære, hvor overdreven varme, fugtighed eller ætsende materialer er til stede. Referer til brugerhåndbogen for driftsparametre.

Stil kølede bade i en opretstående position ved stuetemperatur (~25 °C) i 24 timer, før du starter. Dette sikrer, at smøreløjen dræner tilbage ind i kompressoren.

Forbind badet til en korrekt jordet stikkontakt.

Kredslobsbeskytteren, der er placeret bag på badet, er ikke beregnet til at fungere som en metode til at afbryde.

Betjen cirkulatoren kun ved brug af den leverede ledning. Hvis cirkulatorens strømledning bruges som en afbrydende enhed, skal den altid være tilgængelig.

Sørg for, at elektriske ledninger ikke er i berøring med nogen af rørforbindelserne eller slangerne.

Påfør aldrig spænding til nogen af badets kommunikationsforbindelser.

Sørg for, at de rør, som du vælger, opfylder dine krav til maksimal temperatur og tryk.

Sørg for, at alle elektriske, og hvis relevant, kommunikationsforbindelser udføres før start.

Brugte kølemidler er tungere end luft og, hvis der er en læk, vil erstatte oxygenen, hvilket forårsager tab af bevidsthed. Kontakt med lækkende kølemiddel vil forårsage hudforbrændinger. Se cirkulatorens navneplade for den brugte kølemiddeltipe og så producentens mest aktuelle amk. sikkerhedsdatablad (SDS), tidligere kendt som MSDS, samt EUs sikkerhedsdatablad for yderligere oplysninger.

Sørg for, at alle reservoirdrænporte er lukkede og at alle rørforbindelser er sikrede. Sørg også for, at alle rester fjernes grundet før påfyldning.

For at undgå spild skal du placere dine containere i badet før påfyldning.

Oliebaserede væsker ekspanderer ved opvarmning. Undgå overfyldning af reservoiret.

Brug kun de accepterede væsker, der er opført i håndbogen. Brug af andre væsker annullerer garantien. Brug aldrig 100 % glycol.

Når du bruger vand på over 80 °C, så overvåg væskniveauet tæt, da hyppige påfyldninger vil være påkrævet. Det skaber også damp.

Vandglycol-miksturer kræver påfyldning med rent vand, ellers vil procentdelen af glycol forøges, hvilket resulterer i høj viskositet og dårlig ydelse.

Før du bruger nogen godkendt væske, andet end vand, eller når du udfører vedligeholdelse, hvor kontakt med væsken er sandsynlig, så referer til producentens SDS og EC sikkerhedsdatablad for betjeningsforholdsregler.

Sørg for, at ingen giftige gasser kan dannes af væsken. Brændbare gasser kan dannes over væsken under brug.

Når du bruger etylenglycol og vand så kontroller væskekoncentrationen og pH på jævnlig basis. Ændringer i koncentration og pH kan påvirke systemets ydelse.

Sørg for, at over-temperaturskæringspunktet er indstillet lavere end brandpunktet for den valgte varmetransfervæske.

Den højeste driftstemperatur, som defineret af EN 61010 (IEC 1010), skal være begrænset til 25 °C under brandpunktet af badvæsken.

Sørg for, at væsken er på sikre temperaturer (under 40 °C) før håndtering eller dræning.

Bejlen aldrig beskadiget eller lækkende udstyr, eller hvis det har nogen beskadigede ledninger.

Bejlen aldrig badet uden væske i reservoiret.

Bejlen aldrig badet eller tilføj væsker til reservoiret med panelemer fjernet.

Rengør ikke badet med opløsningsmidler, brug en blød klud og vand.

Dræn reservoiret, før det transporteres og/eller opbevares i, nær eller under frosttemperaturer.

Sluk altid for badet, og afbryd forsyningsspændingen fra strømkilden, før du flytter eller udfører nogen servicering- eller vedligeholdelsesprocedurer. Referer servicering og reparation til en kvalificeret tekniker. Transporter badet forsigtigt. Pludselige stød eller tab kan beskadige dets komponenter.

Brugeren er ansvarlig for dekontaminering, hvis der spildes farlige materialer. Konsulter producenten ang dekontaminering og/eller rengøringsmiddelkompatibilitet.

Hvis badet skal transporteres og/eller opbevares i kold temperatur, skal det drænes og så skylles med en 50/50 glycol/vand-mikstur af laboratoriekvalitet.

Dekommissionering skal kun udføres af en kvalificeret forhandler ved brug af certificeret udstyr. Alle gældende regulativer skal følges.

Udførelse af installations-, drifts- eller vedligeholdelsesprocedurer andet end dem, der er beskrevet i denne håndbog, kan resultere i farlige situationer og annullere producentens garanti.

For Sahara-bade og stand-alone nedsænkningssirkulatorer skal du bruge den medfølgende møtrik og spændeskive for at sikre jordingsstrømmen til toppen af metaltanken.

Bedtjen aldrig badet med den fjernede nedsænkningssirkulator.

Monter ikke nedsænkningssirkulatoren baglæns, ledningen kunne komme i kontakt med reservoirtæske.

Transparent akryllisk og polypropylenoxid (PPO) bade bruges kun med vand.

Juster badets software til at godkende den brugte væske.

## Installation af Arctic-, Glacier- og Sahara-badcirkulatorer:



Sørg for, at elledningerne ikke kommer i kontakt med nogen af rørforbindelserne eller slangerne.

For nedkølede bade skal du installere det medfølgende RJ45 afskærmede kabel mellem nedsænkningssirkulatoren og badets RJ45 forbindelser (lig med Ethernet). Dette er påkrævet for korrekt drift.

For nedkølede bade skal du installere strømledningen fra stikforbindelsen bag på controlleren, A, til stikforbindelsen bag på det nedkølede bad, B. Forbind badets strømledning, C, til en jordet stikkontakt.

Ved nedkølede bade må du aldrig forbinde controllerens strømindtag, A, til en strømstikkontakt. Forbind aldrig strømstikkontakt, B, til andet end en nedsænkningssirkulator.

Ved ikke-nedkølede bade skal du forbinde badets strømledning, C, til et jordet strømudtag.

Rørforbindelserne til ekstern cirkulation befinder sig bag på nedsænkningssirkulatoren.  er returstrømmen fra den eksterne applikation.  er udløbsstrømmen til den eksterne applikation (forsyningsside). Forbindelserne er 16 mm O.D. Fjern foreningsmøtrikkerne- og pladerne for at installere de 8 mm eller 12 mm slangehager og -klemmer, der følger med cirkulatoren.

For at forebygge skade på cirkulatorens rør skal du bruge en 19 mm backing-nøgle, når du fjerner/installere forbindelserne.

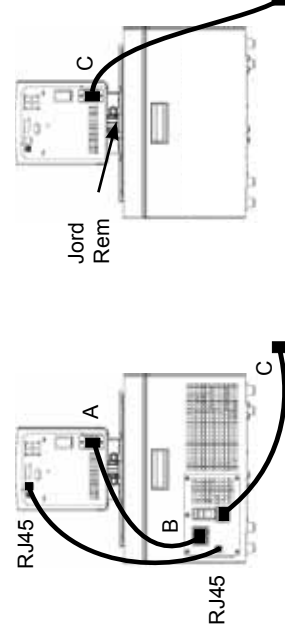



## Βασικές οδηγίες ασφαλείας Λουτρό εργαστηρίου

Εάν οποιαδήποτε από αυτές τις οδηγίες δεν είναι κατανοητή, ανατρέξτε στο εγχειρίδιο ή επικοινωνήστε μαζί μας πριν προχωρήσετε.

### Ασφάλεια, όλα τα προϊόντα:



Υποδεικνύει άμεση κατάσταση κινδύνου που αν δεν αποφευχθεί, μπορεί να προκαλέσει θάνατο ή σοβαρό τραυματισμό.



Υποδεικνύει δυνητικά επικίνδυνη κατάσταση που αν δεν αποφευχθεί, μπορεί να προκαλέσει θάνατο ή σοβαρό τραυματισμό.



Υποδεικνύει δυνητικά επικίνδυνη κατάσταση που αν δεν αποφευχθεί, μπορεί να προκαλέσει μικρό ή ήπιο τραυματισμό. Μπορεί να χρησιμοποιηθεί και ως προειδοποίηση μη ασφαλών πρακτικών.



για την προειδοποίηση του χρήστη σχετικά με την παρουσία μην-μονωμένης "επικίνδυνης τάσης" μέσα στο περίβλημα του κυκλοφορητή. Το μέγεθος της τάσης είναι αρκετά σημαντικό ώστε να αποτελέσει κίνδυνο ηλεκτροπληξίας.



υποδεικνύει την παρουσία ζεστών επιφανειών



υποδεικνύει ανόγκνωση του εγχειριδίου.



Η ετικέτα αυτή δηλώνει ότι χρησιμοποιείται εύφλεκτο ψυκτικό.

Μη χρησιμοποιείτε το λουτρό ως αποστειρωμένη συσκευή ή συσκευή συνδεδεμένη με τον ασθενή. Επιπλέον, το λουτρό δεν έχει σχεδιαστεί για χρήση στην Κατηγορία I, II ή III Επικίνδυνες Θέσεις από τον Εθνικό Ηλεκτρολογικό Κώδικα.

Ποτέ μην τοποθετείτε λουτρό σε τοποθεσία ή σε περιβάλλον με υπερβολική ζέση, υγρασία ή παρουσία διαβρωτικών υλικών. Ανατρέξτε στις λειτουργικές παραμέτρους του εγχειριδίου χρήστη.

Αφήνετε τα παγωμένα λουτρά σε κατακόρυφη θέση, σε θερμοκρασία δωματίου (~25°C) για 24 ώρες πριν την έναρξη. Αυτό εξασφαλίζει ότι το λάδι λίπανσης θα εισρεύσει μέσα στον συμπιεστή. Συνδέστε το λουτρό σε κατάλληλα νευωμένη έξοδο.

Το προστατευτικό κυκλώματος που βρίσκεται στο πίσω μέρος του λουτρού δεν θα πρέπει να χρησιμοποιείται ως μέσο αποσύνδεσης.

Λειτουργήστε τον κυκλοφορητή χρησιμοποιώντας μόνο το κορδόνι γραμμής. Αν το καλώδιο ισχύος του κυκλοφορητή χρησιμοποιηθεί ως συσκευή αποσύνδεσης, θα πρέπει να είναι εύκολα προσβάσιμο ανά πάσα στιγμή.

Βεβαιωθείτε ότι τα ηλεκτρικά καλώδια δεν έρχονται σε επαφή με τις υδραυλικές συνδέσεις ή τις σωληνώσεις.

Ποτέ μην δίνετε τάση γραμμής σε οποιαδήποτε τις συνδέσεις επικοινωνίας.

Βεβαιωθείτε ότι οι σωληνώσεις που έχετε επιλέξει πληρούν τις μέγιστες προϋποθέσεις θερμοκρασίας και πίεσης.

Βεβαιωθείτε ότι όλες οι ηλεκτρικές, και εφόσον υφίστανται, οι συνδέσεις επικοινωνίας έχουν γίνει πριν την έναρξη.

Τα ψυκτικά που χρησιμοποιούνται είναι βαρύτερα από τον αέρα και εάν υπάρχει διαρροή, θα αντικαταστήσουν το οξυγόνο και θα προκαλέσουν απώλεια αισθήσεων. Η επαφή με ψυκτικό διαρροής θα προκαλέσει εγκαύματα στο δέρμα. Ανατρέξτε στην πινακίδα για τον τύπο του ψυκτικού που χρησιμοποιείται και το τρέχον Φύλλο Δεδομένων Ασφαλείας Η.Π.Α (SDS) γνωστά ως MSDS και το Φύλλο Δεδομένων Ασφαλείας Ε.Ε. για περισσότερες πληροφορίες.

Βεβαιωθείτε ότι τυχόν θυρίδες αποστράγγισης της δεξαμενής έχουν κλείσει και ότι όλες οι υδραυλικές συνδέσεις είναι ασφαλισμένες. Επίσης, βεβαιωθείτε ότι τυχόν υπολείμματα έχουν αφαιρεθεί με προσοχή πριν το γέμισμα.

Για την αποφυγή διαρροών, τοποθετήστε τα δοχεία σε λουτρό πριν το γέμισμα.

Τα υγρά με βάση τα έλαια διαστέλλονται όταν θερμαίνονται. Αποφύγετε την υπερπλήρωση της δεξαμενής.

Χρησιμοποιήστε μόνο συγκεκριμένα υγρά που αναφέρονται στο εγχειρίδιο. Η χρήση άλλων υγρών ακυρώνει την εγγύηση. Ποτέ μη χρησιμοποιείτε γλυκόλη 100%.

Όταν χρησιμοποιείτε νερό με θερμοκρασία άνω των 80°C, ελέγχετε προσεκτικά τη στάθμη του υγρού, θα χρειάζονται συχνά γεμίσματα. Επίσης, δημιουργεί αήμι.

Τα μείγματα νερού/γλυκόλης απαιτούν γέμισμα με καθαρό νερό, διαφορετικά το ποσοστό της γλυκόλης θα αυξηθεί και θα δώσει υψηλό ιξώδες και χαμηλές επιδόσεις.

Εκτός από νερό, πριν χρησιμοποιήσετε οποιοδήποτε συγκεκριμένο υγρό ή κατά τη διαδικασία της

συντήρησης όπου η επαφή με το υγρό είναι πιθανή, ανατρέξτε στα Φύλλα Δεδομένων Ασφαλείας SDS και EC του κατασκευαστή για προφυλάξεις κατά τον χειρισμό.

Βεβαιωθείτε ότι το υγρό δε δημιουργεί τοξικά αέρια. Τα εύφλεκτα αέρια ενδέχεται να συσσωρευτούν πάνω από το υγρό κατά τη διάρκεια της χρήσης.

Κατά τη χρήση αιθυλενο-γλυκόλης και νερού, ελέγχετε τακτικά τη συγκέντρωση του υγρού και του pH. Οι αλλαγές σε συγκέντρωση και pH ενδέχεται να επηρεάσουν τις επιδόσεις του συστήματος.

Βεβαιωθείτε ότι η διακοπή λόγω θερμοκρασίας έχει ρυθμιστεί χαμηλότερα από το σημείο πυροδότησης για το υγρό μεταφοράς που έχει επιλεγεί.

Η υψηλότερη θερμοκρασία λειτουργίας, όπως ορίζεται βάσει EN 61010 (IEC 1010), θα πρέπει να είναι περιορισμένη στους 25°C κάτω από το σημείο πυροδότησης του υγρού του λουτρού.

Βεβαιωθείτε ότι το υγρό έχει ασφαλή θερμοκρασία (κάτω των 40°C) πριν τον χειρισμό ή την απόρριψή του.

Ποτέ μη λειτουργείτε εξοπλισμό που έχει υποστεί βλάβη ή παρουσιάζει διαρροές ή χαλασμένα καλώδια. Μη λειτουργείτε το λουτρό χωρίς ψυκτικό υγρό μέσα στη δεξαμενή.

Ποτέ μη λειτουργείτε το λουτρό και μην προσθέτετε υγρό στη δεξαμενή εάν τα πλαίσια έχουν αφαιρεθεί. Μην καθαρίζετε το λουτρό με διαλύτες, χρησιμοποιήστε αποκλειστικά απαλό πανί και νερό.

Αποστραγγίστε τη δεξαμενή πριν τη μεταφορά και/ή την αποθήκευση σε θερμοκρασίες κάτω της ψύξης. Σβήνετε πάντα το λουτρό και αποσυνδέστε την τάση τροφοδοσίας από την πηγή τροφοδοσίας πριν τη μετακίνηση ή το σέρβις και τις διαδικασίες συντήρησης. Για σέρβις και επισκευές απευθυνθείτε σε εξειδικευμένο τεχνικό.

Μεταφέρετε το λουτρό με προσοχή. Ξαφνικά τραντάγματα ή πτώσεις ενδέχεται να προκαλέσει βλάβες στα εξαρτήματα.

Ο χρήστης φέρει την ευθύνη για τον καθαρισμό ή την απολύμανση, εφόσον υπάρξει διαρροή επικινδύνων υλικών. Συμβουλευτείτε τον κατασκευαστή για τον καθαρισμό και/ή τη συμβατότητα των καθαριστικών.

Αν το λουτρό πρέπει να μεταφερθεί και/ή να αποθηκευτεί σε χαμηλή θερμοκρασία, θα πρέπει να αποστραγγιστεί και να εκπλυθεί με εργαστηριακό μείγμα γλυκόλης/νερού, 50/50.

Η θέση εκτός λειτουργίας θα πρέπει να εκτελείται από εξειδικευμένο προμηθευτή με τη χρήση πιστοποιημένου εξοπλισμού. Όλοι οι κανονισμοί εν ισχύ θα πρέπει να τηρούνται.

Οι διαδικασίες εγκατάστασης, λειτουργίας ή συντήρησης εκτός από εκείνες που περιγράφονται στο εγχειρίδιο ενδέχεται να προκαλέσουν επικίνδυνες καταστάσεις και ακώρωση της εγγύησης του κατασκευαστή.

Για τα λουτρά Sahara με μεμονωμένους κυκλοφορητές εμφύθισης, χρησιμοποιήστε το περικόχλιο και το παζιμάδι που παρέχονται για να ασφαλίσετε τον μάντα γείωσης στο άνω μέρος της μεταλλικής δεξαμενής.

Ποτέ μην λειτουργείτε το λουτρό χωρίς των κυκλοφορητή εμφύθισης.

Μη συναρμολογείτε τον κυκλοφορητή εμφύθισης αντίστροφα. Το καλώδιο γραμμής μπορεί να έρθει σε επαφή με το υγρό της δεξαμενής.

Διαγνή λουτρά ακρυλικού και οξείδιου που πολυπροπυλενίου (PPO) χρησιμοποιούνται μόνο με νερό.

Ρυθμίστε το λογισμικό του λουτρού ώστε να συμφωνεί με το υγρό που χρησιμοποιείται.

## Εγκατάσταση για τους κυκλοφορητές λουτρού Arctic, Glacier και Sahara:

Βεβαιωθείτε ότι τα ηλεκτρικά καλώδια δεν έρχονται σε επαφή με τις υδραυλικές συνδέσεις ή τις σωληνώσεις.

Για παγωμένα λουτρά, τοποθετήστε το θωρακισμένο καλώδιο RJ45 μεταξύ του κυκλοφορητή εμφύθισης και των συνδέτων του λουτρού RJ45 (παρόμοιο με το Ethernet). Αυτό είναι απαραίτητο για τη σωστή λειτουργία.

Για παγωμένα λουτρά, εγκαταστήστε το κορδόνι τροφοδοσίας από τον συνδέτη στο πίσω μέρος του ελεγκτή, A στο συνδέτη στο πίσω μέρος του παγωμένου λουτρού B. Συνδέστε το καλώδιο ρεύματος C, σε γειωμένη έξοδο ισχύος.

Για παγωμένα λουτρά, ποτέ μη συνδέετε την είσοδο ισχύος του ελεγκτή A στην έξοδο ισχύος. Ποτέ μην συνδέετε την έξοδο ισχύος B σε οπδήποτε άλλο εκτός από κυκλοφορητή εμφύθισης.

Για μη-παγωμένα λουτρά, συνδέστε το καλώδιο τροφοδοσίας του λουτρού C, σε γειωμένη έξοδο ισχύος.

Οι υδραυλικές σωληνώσεις εξωτερικής κυκλοφορίας βρίσκονται στο πίσω μέρος του κυκλοφορητή εμφύθισης. → ● είναι η επιστροφή ροής από την εξωτερική εφαρμογή, ● → είναι η ροή εξόδου στην εξωτερική εφαρμογή (πλευρά παροχής). Οι συνδέσεις είναι 16 mm O.D. Αφαιρέστε τα παζιμάδια και τις πλάκες συνένωσης για να τοποθετήσετε ακίδες σωλήνων και σφιγκτήρες 8 mm ή 12 mm που παρέχονται μαζί με τον κυκλοφορητή.

Για την αποφυγή βλαβών στα υδραυλικά του κυκλοφορητή, χρησιμοποιήστε ένα κλειδί 19 mm κατά την αφαιρεση/εγκατάσταση των εξωτερικών συνδέσεων.

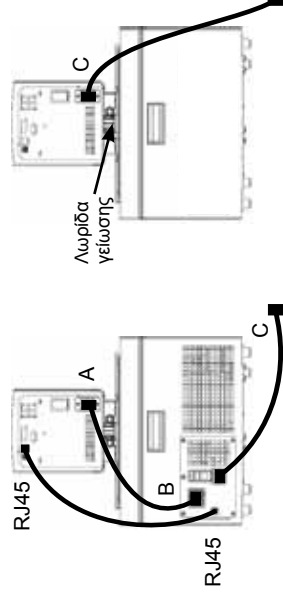



# Olulised ohutusjuhised Laboratooriumi vesivannid

Kui mistahes juhised ei ole arusaadavad, siis enne jätkamist vaadake kasutusjuhendit või võtke meiega ühendust.

## Ohutus, kõik tooted:

 tähistab otsest ohtlikku olukorda, millele tähelepanu pööramata jätmine võib põhjustada surma või tõsise vigastuse.

 tähistab potentsiaalselt ohtlikku olukorda, millele tähelepanu pööramata jätmine võib põhjustada surma või tõsise vigastuse.

 tähistab potentsiaalselt ohtlikku olukorda, millele tähelepanu pööramata jätmine võib põhjustada väiksema või keskmise raskusega vigastuse. Seda kasutatakse ka ohtlikust tegevusest hoiatamiseks.

 ettenähtud kasutaja hoiatamiseks ringluspumba korpusel olevast isoleerimata "ohtlikust pingest".  
Pinge tugevus on piisav elektrilöögi tekitamiseks.

 tähistab kuumade pindade olemasolu.

 tähistab kasutusjuhendi vaatamise vajadust.

 See märgis näitab tuleohtlikku külmutusagensi kasutamist.

Ärge kasutage vesivanni steriliseerimise seadmetena või patiensidiga ühendatavate seadmetena. Lisaks eelnevale, ei ole vesivann ettenähtud kasutamiseks I, II või III klassi ohtlikes rakendustes vastavalt NEC nõuetele.

Ärge kunagi paigutage vesivanni ülemäärase kuumusega ja niiskusega kohtadesse või keskkondadesse või söövitatavate materjalide lähedale. Vaadake tööparameetreid kasutusjuhendist.

Enne käivitamist jätkake jahutatavad vesivannid pistisesse asendisse toatemperatuuril (~25°C) 24-ks tunniks. See tagab määrdeõli voolamise tagasi kompressorisse.

Ühendage vesivann nõuetekohaselt maandatud seinapistikuga.

Vesivanni tagaosa asuv kontuurikaitse ei ole ettenähtud seadme toitevõrgust lahtiühendamiseks.

Kasutage ringluspumpa ainult kaasasoleva toitejuhtmega. Kui ringluspumba toitejuhet kasutatakse toitevõrgust lahtiühendamiseks, siis peab olema kogu aeg lihtsalt juurdepääsetav.

Veenduge, et elektrijuhtmed ei puutu kokku toruühendustega või torudega.

Ärge kunagi rakendage võrgupinget vesivanni mistahes andmesideühendustele.

Veenduge, et kasutatavad torud vastavad maksimaalsetele temperatuuri ja surve nõuetele.

Enne käivitamist veenduge, et kõik elektrühendused ja vajadusel ka andmesideühendused, on teostatud nõuetekohaselt.

Kasutatavad jahutusained on õhust raskemad ning tõrjuvad lekke korral õhu välja ning võivad põhjustada meelemärguse kadu. Lekkiva jahutusainega kokkupuutumine põhjustab nahapõletusi. Lisateabeaks kasutatava jahutusaine kohta vaadake ringluspumba andmeplaati ja tootja kõige hilisemat ohutuskaarti (SDS, MSDS, EL ohutuskaart).

Veenduge, et mahuti kõik tühjendusavad on suletud ning toruühendused on kindlalt kinni. Enne vesivanni täitmist veenduge, et see on täiesti puhas.

Mahavoolamise ärahoidmiseks asetage mahutid vesivanni enne vesivanni täitmist.

Soojendamisel õlialusel vedelikud paisuvad. Vältige mahuti üleitäitmist.

Kasutage ainult kasutusjuhendis kirjeldatud heakskiidetud vedelikke. Muude vedelike kasutamine muudab garantii kehtetuks. Ärge kunagi kasutage 100%-st glükooli.

Kui kasutate üle 80°C vett, siis jälgige tähelepanelikult vedeliku taset, vajadusel lisage vedelikku juurde. See võib põhjustada auru teket.

Vesi/glükool segude korral on vaja lisada puhast vett, vastasel juhul suureneb glükooli sisaldus, mis toob kaasa suurema viskoossuse ja mittenõuetekohase toimimise.

Veeest erinevate heakskiidetud vedelike kasutamisel või hoolduse korral, kus on tõenäoline kokkupuude vedelikuga, vaadake ohutusnõuete järgimiseks tootja ohutuskaarti (SDS, MSDS, EL ohutuskaart).

Veenduge, et vedelik ei tekita mürgiseid gaase. Kasutamise ajal võivad vedeliku kohale tekkida tuleohtlikud gaasid.

Etüüleenglükooli ja vee kasutamisel kontrollige regulaarselt vedeliku kontsentratsiooni ja pH-taset.

Kontsentratsiooni ja pH-taseme muutused võivad mõjutada süsteemi toimimist.

Veenduge, et temperatuurikaitse väljalülitamispunkt on seadistatud madalamale, kui valitud soojuskandja vedeliku süttimispunkt.

Kõige kõrgem töotemperatuur vastavalt EN 61010 (IEC 1010) standardile peab olema seadistatud 25°C võrra madalamale tasemele, kui on veevanni vedeliku süttimispunkt.

Veenduge, et vedelik on enne käsitlemist või väljalaskmist ohutult temperatuuril (alla 40°C).

Ärge kasutage kunagi kahjustatud või lekkivat seadet või kahjustatud toitejuhtmega seadet.

Ärge kasutage vesivanni kunagi ilma vedelikuta mahutiga.

Ärge kasutage vesivanni või lisage vedelikku eemaldatud paneelidega mahutisise.

Ärge puhastage vesivanni lahusifitega, kasutage pehmet lappi ja vett.

Tühjendage mahuti enne transportimist ja/või enne ladustamist külmumistemperatuuril lähedal või sellest allpool.

Enne seadme liigutamist või mistahes hooldustööde läbiviimist lülitage vesivann atäti välja ja ühendage lahti toitevõrgust. Hooldamisel ja remondi korral pöörduge kogemustega tehniku poole.

Vesivanni transportimisel olge eriti ettevaatlikud. Ootamatud pöörutused ja kukkumised võivad kahjustada seadme komponente.

Kui mahavoolanud materjal on ohtlik, siis vastutab desinfitseerimise eest kasutaja. Desinfitseerimise ja puhastusainete sobivuse osas võtke ühendust tootjaga.

Kui vesivanni on vaja transportida ja/või ladustada madalate temperatuuride tingimustes, siis tuleb see tühjaks lasta ning seejärel loputada laboris kasutatava glükooli/vee 50/50 seguga.

Kasutusest eemaldamisel pöörduge sertifitseeritud seadmeid kasutava kogemustega ettevõtte poole. Järgige kõiki kehtivaid eeskirju.

Kasutusjuhendis kirjeldamata paigaldamis-, iõötamis- või hooldusprotseduurid võivad kaasa tuua ohtliku olukorra ning muudavad garantii kehtetuks.

Sahara vesivannide ja eraldiseisvate immersioonringluspumpade korral kasutage maandusriba kinnitamiseks metallmahuti peale kaasasolevat mutrit ja seibi.

Ärge kunagi kasutage eemaldatud immersioonringluspumpaga vesivanni.

Ärge paigaldage immersioonringluspumpa tagurpidi; juhe võib puudutada vedeliku mahuti.

Läbipaistvaid akrüülisi ja polüfentüleenoksiidist (PPO) vesivanne on lubatud kasutada ainult veega.

Seadistage vesivanni tarkvara vastavalt kasutatavale vedelikule.

## Arctic, Glacier ja Sahara vesivanni ringluspumpade paigaldamine:

Veenduge, et elektrijuhitmed ei puutuks kokku mistahes toruühendustega või voolikutega.

Paigaldage jahutusega vesivannidele tarmekomplektis olev RJ45 varjestatud juhe immersioonringluspumba ja vesivanni RJ45 pistikute vahele (sarnane Ethernet ühendusega). See on vajalik nõuetekohase töötamise tagamiseks.

Paigaldage jahutusega vesivannidele toitejuhe kontrolleri A tagaosas asuvas pistikust kuni jahutusega vesivanni tagaosas asuva pistikuni B. Ühendage vesivanni toitejuhe C maandusega seinapistikuga.

Ärge kunagi ühendage jahutusega vesivannide kontrolleri toitesisendit A, toiteväljundiga. Ühendage toiteväljund B atäti ainult immersioonringluspumbaga.

Ühendage jahutusega vesivanni toitejuhe C maandusega seinapistikuga.

Välise ringluse toruühendused asuvad immersioonringluspumba tagaosas. ➔ tagastusvool välisest seadmest. ● ➔ väljavool välisesse seadmesse (toitepool). Ühendused 16 mm välisliibimööduga.

Ringluspumba tarmekomplektis olevate 8 mm ja 12 mm voolikute kinnitusotsikute paigaldamiseks eemaldage ülemutrid ja plaadid.

Ringluspumba torustiku kahjustamise ärahoidmiseks kasutage väliste ühenduste eemaldamisel/ paigaldamisel 19 mm silmusvõtit.

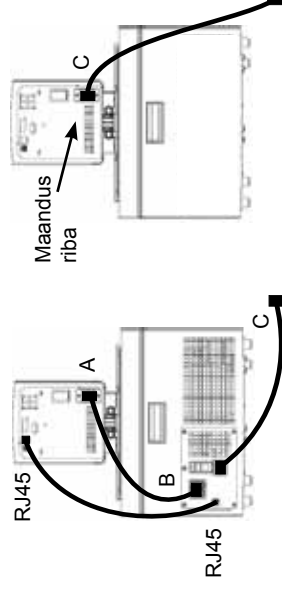



## Olennaiset turvaohjeet Laboratorio hauteet

Jos nämä ohjeet eivät ole selviä, viittaa ohjekirjaan tai ota meihin yhteyttä ennen kuin jatkat eteenpäin.

### Turvallisuus, kaikki tuotteet:

 osoittaa välitöntä vaaratilannetta, joka johtaa kuolemaan tai vakavaan loukkaantumiseen, ellei sitä välletä.

 osoittaa potentiaalisen vaaratilanteen, joka voi johtaa kuolemaan tai vakavaan loukkaantumiseen, ellei sitä välletä.

 osoittaa potentiaalisen vaaratilanteen, joka saattaa aiheuttaa pienen tai kohtalaisen vamman, ellei sitä välletä. Sitä käytetään varoittamaan myös vaarallisista tavoista.

 tarkoitettu varoittamaan käyttäjää eristämättömästä "vaarallisesta jännitteestä" kiertojärjestelmän kotelon sisällä. Jännitteen voimakkuus on merkittävä sähköiskuvaaran aiheuttamiseksi.

 osoittaa kuumien pintojen paikallaoloa.

 osoittaa ohjekirjan lukemiseen liittyvää veloitusta.

 Tämä etiketti osoittaa, että käytetään palavaa kylmäainetta.

Älä käytä haudetta steriilinä varusteena tai potilaaseen yhdistettynä. Haudetta ei ole suunniteltu käytettäväksi National Electrical Code -sääntöjen mukaisesti I, II tai III luokan tiloissa.

Älä koskaan sijoita haudetta paikkaan tai ympäristöön jossa esiintyy liiallista kuumuutta, kosteutta tai syövyttäviä materiaaleja. Viittaa käyttöohjeeseen käyttöparametrejä varten.

Jätä jäähdytetyt hauteet pystyasentoon huonelämpötilaan (~25 °C) 24 tunniksi ennen niiden käynnistystä. Tämä takaa voiteluöljyn paluun kompressorin.

Liitä haude maadoitettuun pistorasiaan.

Hauteen takana olevaa piiriä suojusta ei ole tarkoitettu käytettäväksi irtkytkentävälineenä.

Käynnistä kiertoeleini käyttämällä vain varustuksiin kuuluvan verkkojohtoa. Jos kiertoeleimen virtajohtoa käytetään irtkytkentäilaitteena, siihen on päästävä aina helposti.

Varmista, etteivät sähköjohdot pääse kosketuksiin putkistojen ja niiden liittimien kanssa.

Älä koskaan kytke verkkojännitettä hauteen yhteysliitoksiin.

Varmista, että valittu putkisto täyttää lämpötilalle ja paineelle asetetut enimmäisvaatimukset.

Varmista ennen käynnistystä, että kaikki sähkö- ja yhteysliitokset, jos sovellettavissa, on tehty.

Käytetyt jäähdytysaineet ovat ilmaan verrattuna painavampia, ja jos vuotoa esiintyy, se korvaa hapen aiheuttamalla tajuun menettämisen. Kosketus vuotavaan jäähdytysaineeseen aiheuttaa palovammoja.

Lisätietoja varten viittaa kiertoeleimen arvokilpeen koskien käytettyä jäähdytysainetta ja valmistajan päivitettyihin käyttöturvallisuustietoihin (US Safety Data Sheet - SDS), jotka tunnettiin aiemmin nimellä MSDS, sekä EU:n käyttöturvallisuustietoihin.

Varmista, että mahdolliset säiliön tyhjennysportit on suljettu ja että kaikki putkistojen liitokset ovat varmoja. Varmista myös, että kaikki mahdolliset jäämät poistetaan kokonaan ennen täyttöö.

Tiputuksen syntymisen estämiseksi, laita säilytysastiat hauteeseen ennen täytön alkamista.

Öljypohjaiset nesteet laajenevat kun niitä kuumennetaan. Vältä säiliön täyttämistä liikaa.

Käytä vain ohjekirjassa lueteltuja hyväksytyitä nesteitä. Muiden nesteiden käyttö mitätöi takuun. Älä koskaan käytä 100 % glykolia.

Kun yli 80 °C vettä käytetään, valvo tarkkaan nesteen tasoa, sillä sen toistuva lisääminen voi olla tarpeen. Kyseisessä tilassa syntyy myös höyryä.

Vesiglykooliseokset vaativat puhtaan veden lisäämistä. Muussa tapauksessa glykolin prosenttiarvo lisääntyy aiheuttaen korkeaa viskositeettiä ja huonon suorituskyvyn.

Veden lisäksi, ennen muiden hyväksytyjen nesteiden käyttöä tai kun suoritetaan huoltotoimenpiteitä joissa voi syntyä kosketus nesteeseen, viittaa valmistajan toimittamiin SDS- ja ED-käyttöturvallisuustietoihin noudatettavia varotoimenpiteitä varten.

Varmista, että neste ei aiheuta myrkyllisiä kaasuja. Palavia kaasuja voi keraantya käytön aikana nesteeseen.

Jos etyleeniglykolia ja vettä käytetään, tarkista säännöllisesti nesteen pitoisuus ja pH-arvo. Pitoisuudessa ja pH-arvossa syntyvät muutokset voivat vaikuttaa järjestelmän suorituskykyyn.

Varmista, että ylälämpötilan kalkaisupiste on asetettu palamispisteeseen nähden alhaisemmalle tasolle valittua lämmönsiirtonestettä varten.

EN 61010 (IEC 1010) standardin mukaan määritetty korkein käyttölämpötila on rajoitettava 25 °C:een alle haudenesteen palamispisteeseen.

Varmista, että nesteen lämpötila on turvallinen (alle 40 °C) ennen sen käsittelyä tai tyhjentämistä.

Älä koskaan käynnistä vahingoittuneita tai vuotavia laitteita tai jos vahingoittuneita johtoja esiintyy.

Älä koskaan käynnistä haudetta ellei säiliössä ole jäähdytysnestettä.

Älä koskaan käytä haudetta tai lisää nestettä säiliöön jos paneelit on irrotettu.

Älä puhdistaa haudetta liuottimilla, käytä pehmeää liinaa ja vettä.

Tyhjennä säiliö ennen sen kuljettamista jalkai varastointia jäätymissämpötilan läheisyydessä tai sen alle. Sammuta haude aina ja irrota virransyöttö virtalähteestä ennen sen liikkuttamista tai huoltotoimenpiteiden suorittamista. Jätä korjaus- ja huoltotyöt pätevän teknikon tehtäväksi.

Siirrä haudetta varovaisesti. Äkilliset tärinäkset tai putoamiset voivat vahingoittaa siihen kuuluvia osia.

Käyttäjät on vastuussa puhdistuksesta jos vaarallisia materiaaleja vuotaa. Käännä valmistajan puoleen liittyen puhdistukseen jalkai puhdistusaineiden yhdenmukaisuuteen.

Jos haudetta on kuljetettava jalkai säilytettävä kylmässä lämpötilassa, se on tyhjennettävä ja huuhdeltava laboratorioasteisella 50/50 glykooli/vesiseoksella.

Käytöstä poistaminen on suoritettava yksinomaan pätevän jälleenmyyjän toimesta sertifioituja varusteita käyttämällä. Noudata kaikkia voimassa olevia määräyksiä.

Muiden kuin tässä ohjekirjassa kuvattujen asennus-, käyttö- tai huoltotoimenpiteiden suorittaminen voi aiheuttaa vaarallisen tilanteen ja miätoிடා valmistajan myöntämän takuun.

Sahara hauteille ja itsenäisille upotettaville kiertoilimille käytä varustuksiin kuuluvaa mutteria ja aluslevyä maadoitusliuskan kiinnittämiseksi metallisäiliön päälle.

Älä koskaan käytä haudetta upotettava kiertoilin irrotettuna.

Älä asenna upotettavaa kiertoilintä päinvastoin; verkkojohto voi joutua kosketuksiin säiliössä olevan nesteen kanssa.

Polyfenylenioksidi- (PPO) ja läpinäkyviä akryylihauteita käytetään vain vedellä.

Aseta hauteen ohjelmisto käytetyn nesteen mukaan.

## Asennus Arctic, Glacier ja Sahara kiertohauteille:

Varmista, etteivät sähköjohdot pääse kosketuksiin putkistojen ja niiden liittimien kanssa.

Jäähdytettäviä hauteita varten asenna toimitukseen kuuluva suojattu johdin RJ45 upotetun kiertoilimen ja hauteen RJ45 liittimien väliin (Ehmet-liittimien kaltainen). Tätä vaaditaan sen oikean toiminnan kannalta.

Jäähdytettäviä hauteita varten, asenna virtajohto ohjaimen takaosasta A jäähdytetyn hauteen takaosaan B. Liitä hauteen virtajohto C maadoitettu virtalähteeseen.

Jäähdytettäviä hauteita varten älä koskaan liitä ohjaimen virran sisäänmeno A virran ulostuloon. Älä koskaan liitä virtalähdettä B muuhun kuin upotettuun kiertoilimeen.

Ei jäähdytetyissä hauteissa, liitä hauteen virtajohto C maadoitettuun pistorasiaan.

Putkiliitokset ulkoista kiertoa varten sijaitsevat upotetun kiertoilimen takana. ● on ulkoisen sovelluksen paluuvirtaus. ● → on ulkoisen sovelluksen ulosmenovirtaus (syöttöpuoli). Kyseessä ovat 16 mm:n O.D.-liittännät. Irrota liittosmutterit ja aluslevyt asentaaksesi kiertoilimen mukana toimitetut 8 mm:n tai 12 mm:n letkuliittimet ja kiinnikkeet.

Estääksesi kiertoilimen putkille syntyviä vahinkoja, käytä 19 mm:n avainta ulkoisten liittimien irrottamisessa/asentamisessa.

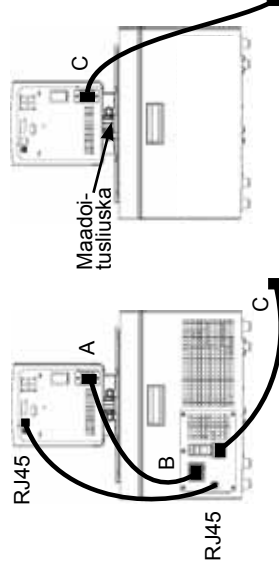



## Treoracha Riachtanacha Sábháilteachta Folcadáin Saotharlainne

Má tá aon treoir ann nach dtuigtear, ceadaigh an lámhleabhar nó déan teagmháil linn sula dtéann tú níos faide.

**Sábháilteacht, gach táirge:**



Iéiríonn sé staid ghuaiseach as a leanfaidh bás nó tromghortú, mura seachnaítear í.



Iéiríonn sé staid ghuaiseach, a bhféadfadh bás nó tromghortú a bheith ina thoradh air, mura seachnaítear í.



Iéiríonn sé staid ghuaiseach, as a leanfaidh mionghortú nó dochar measartha, mura seachnaítear í. Úsáidtear é, leis, chun rabhadh a thabhairt i gcás cleachtais neamshábháilte.



ceaptha leis an úsáideoir a chur ar an eolas maidir le “voltag contúirteach” neamhinslithe laistigh d’imfhálú an fhuaraitheora. Tá an voltas suntasach a dhóthain le bheith ina bhaol turrainge leictir.



Iéiríonn sé dromchlaí te.



Iéiríonn sé gur chóir an lámhleabhar a léamh.



Tugann an lipéad seo le fios go n-úsáidtear cuisneán inadhaite.

Ná húsáid an treatlamh mar ghléas steiriúil nó mar ghléas a nasctar le hothar. Lena chois sin, níor ceapadh an treatlamh lena úsáid i Láithreacha Guaiseacha Aicme I, II nó III mar a shainmhínítear sa Chód Náisiúnta Leictreach.

Ná cuir an folcadán in áit nó in atmaisféar ina bhfuil teas iomarcach, taise, nó ábhair chreimneacha.

Ceadaigh lámhleabhar an úsáideora go bhfeice tú na paraiméadair oibríochtúla.

Fág folcadáin chuiseánach ina seasamh go hingearach ag teocht an tseomra (~25°C) ar feadh 24 uaire sula dtosaítear iad. Cinntíonn sé sin go ndraenáilann an ola bealaithe ar ais isteach sa chomhbhruiteoir.

Ceangail an treatlamh d’asraon atá talmhaithe i gceart.

Níl an cosantóir ciorcaid atá suite ar chúil an fholcadáin ceaptha le gníomhú mar mhodh dícheangail.

Ná hoidhrigh an t-athfhillteoir ach amháin leis an corda líne soláthraithe. Má úsáidtear corda cumhachta an athfhillteora mar ghléas dícheangail, ní mór teacht a bheith air i gcónaí.

Cinntigh nach mbiomn aon teagmháil idir na cordaí leictreacha agus aon cheann de na naisc nó an feadánra pluiméireachta.

Ná cuir voltas líne i bhfeidhm ar aon cheann de naisc chumarsáide an fholcadáin.

Cinntigh go gcomhlíonann an feadánra a roghnaíonn tú na riachtanais uasteochta agus uasbhrú.

Cinntigh go ndéantar gach nasc leictreach, agus más cuí, gach nasc cumarsáide sula dtosaítear.

Is airdre ná aer na cuisneáin a úsáidtear, agus má bhíonn sceitheadh ann, gabfaidh siad áit na hosaigine as a leanfaidh cailiúint comhfhéasa. Dófar craiceann i gcás teagmháil idir craiceann agus sceitheadh cuisneáin. Féach ainmphiáta an dáileora go bhfeice tú an cineál cuisneáin a úsáidtear agus ansin féach Leathanach Sonraí Sábháilteachta SA is déanaí an déantóra, an rud a dtugtaí an MSDS air cheana, agus Leathanach Sonraí Sábháilteachta AE chun breis eolais a fháil.

Cinntigh go bhfuil aon phort draenála taiscumair dúnta agus go bhfuil gach nasc pluiméireachta daingean. Cinntigh, leis, go mbaintear aon iarmhar go hiomlán sula líontar.

Chun doirteadh a sheachaint, cuir do ghabhdáin isteach san fholcadán sula líontar iad.

Fairsingíonn leachtanna ola-bhunaithe tar éis iad a théamh. Seachain nach róilontar an taiscumar.

Ná húsáid ach na leachtanna ceadaithe atá liostaithe sa lámhleabhar. Cuirtear an baránta ar neamhní má úsáidtear leachtanna eile. Ná húsáid gliocóil 100% riamh.

Agus uisce is teo ná 80°C a úsáid, coimeád sùil ghéar ar leibhéal an leachta, beidh gá leis an leacht a bharrlionadh go mínic. Cruithófar gal, leis.

Is gá ionúisce a chur le meascáin uisce/gliocóil, nó méadóidh céatadán an gliocóil as a leanfaidh arsladadacht agus drochfheidhmíocht.

Sula n-úsáidtear aon leacht ceadaithe seachas uisce, nó nuair a bhíonn cothabháil á déanamh nuair is dócha go mbeadh teagmháil leis an leacht, ceadaigh SDS agus Leathanach Sonraí Sábháilteachta AE an déantóra go bhfeice tú na réamhchúraimí láimhsithe.

Cinntigh nach féidir leis an leacht aon gháis trocsaineacha a ghléimint. Is féidir le gáis inadhaite cruinníú os cionn an leachta fad a bhíonn sé in úsáid.

Agus gliocóil eitiléine agus uisce á n-úsáid, seiceáil túchán an leachta agus an pH ar bhonn rialta. Is féidir le hathruithe ar thiúchan agus ar pH difear a dhéanamh d’fheidhmíocht an chórais.

Cinntigh go socraítear pointe scoir na huasteochta faoi bhun an phointe dóiteáin i gcás an leachta aistrithe teasa a roghnaítear.

Ní mór an teocht oibre is airde, mar a shainmhínítear in EN 61010 (IEC 1010), a bheith teoranta ag 25°C faoi bhun phointe dóiteáin an leachta folcadáin.

Cinntigh go bhfuil an leacht ag teocht sábháilte (faoi bhun 40°C) sula láimhseáilann nó sula ndraenáilann tú é.

Ná hoidhrigh riamh le treatlamh damáistithe nó treatlamh atá ag sceitheadh, ná le haon chorda damáistithe.

Ná hoidhrigh an folcadán riamh gan leacht a bheith sa taiscumar.

Ná hoidhrigh an folcadán agus ná cuir leacht leis an taiscumar fad a bhíonn na painéil bainte.

Ná glan an folcadán le tuaslagóir, úsáid ceirt bhog agus uisce.

Draenáil an taiscumar sula ndéantar é a iompar, agus/nó a stóráil gar don reophointe nó faoina bhun.

Cas an folcadán as i gcónaí agus dícheangail an voltas soláthair óna fhoinse cumhachta sula mbogtar an folcadán nó sula ndéantar aon seirbhísiú nó obair chothabhála. Iarr ar theicneoir cáilithe gach seirbhísiú agus deisiú a dhéanamh.

Iompar an folcadán go cúramach. Is féidir le croitheadh nó isliú tobann na compháirteanna a dhamáistiú. Is é an t-úsáideoir a bheidh freagrach as dí-éiliú má dhoirtear ábhair ghuaiseacha. Ceadaigh an déantóir maidir le dí-éiliú agus nó oiriúnacht oibreán glantacháin.

Má tá an folcadán le hiompar agus/nó a stóráil ag teocht fuar ní mór é a dhraenáil agus a shruthlú ina dhiaidh sin le meascán gliccóil/uisce 50/50 de ghrád saotharlainne.

Níor chóir ach do dhéileálai cáilithe, a úsáideann trealamh déimhnithe, an gléas a dhíchoimisíú. Ní mór cloí le gach rialachán atá i bhfeidhm.

Féadfaidh staid ghuaiseach agus cur ar neamhní bharánta an déantóra a bheith ina thoradh ar fheidhmiú na nósanna imeachta suiteála, oibriúcháin nó cothabhála seachas iad siúd a ndéantar cur síos orthu sa lámhleabhar.

I gcás folcadán Sahara, agus athfhillteoirí tumtha neamhspleácha, úsáid an cnó agus an leicneán a sholáthraítear chun an strap talmhaithe a dhaingniú de bharr an taiscumair mhíotail.

Ná hoirbigh an folcadán riamh fad a bhíonn an t-athfhillteoir tumtha bainte.

Ná gléas an t-athfhillteoir tumtha ar gcúl. d'fhéadfadh an corda líne dul i dteagmháil le leacht an taiscumair. Is le huisce armháin a úsáidtear folcadáin d'aicrileach trédhearcach agus folcadáin d'ocsaíd pholaitéiléine (PPO).

Coigeartaigh bogearraí an fholcadáin de réir an leachta a úsáidtear.

## Le hAthfhillteoirí Folcadáin Arctic, Glacier agus Sahara a shuiteáil:

Cinntigh nach mbíonn aon teagmháil idir na cordaí leictreacha agus aon cheann de na naisc nó den fheadánra pluiméireachta.

I gcás folcadán cuisniúcháin, suiteáil an cábla RJ45 cumhdaithe idir an t-athfhillteoir tumtha agus naisc RJ45 an fholcadáin (cosúil le Ethernet). Tá sé seo riachtanach chun go n-oibreoidh sé i gceart.

I gcás folcadán cuisniúcháin, suiteáil an corda cumhachta ón nascaire ar chúl an rialtóra, A, leis an nasc ar chúl an fholcadáin chuismíocháin, B. Ceangail corda cumhachta an fholcadáin, C, le hasraon cumhachta talmhaithe.

I gcás folcadán cuisniúcháin, ná ceangail ionraon cumhachta an rialtóra, A, riamh le hasraon cumhachta. Ná ceangail asraon cumhachta, B., riamh le rud ar bith seachas athfhillteoir tumtha.

I gcás folcadán neamhchuismíocháin, ceangail corda cumhachta an fholcadáin, C, le hasraon cumhachta talmhaithe.

Gheofar na naisc pluiméireachta le haghaidh athfilleadh seachtarach ar chúl an athfhillteora tumtha.

→ seo an sreabhadh fillte ón fheidhmiúcháin seachtarach. ● → seo an sreabhadh asraoin chuig an bhfeidhmiúcháin seachtarach (an taobh soláthair). Naisc 16 mm O.D. is ea iad. Bain na cnónna agus na plátaí aontais chun frídíní píobáin 8 mm nó 12 mm agus clampaí a soláthraíodh leis an athfhillteoir a shuiteáil.

Chun damáiste do phluiméireacht an athfhillteora a sheachaint, úsáid rinse tacaíochta 19 mm agus na naisc á mbaint/á suiteáil.

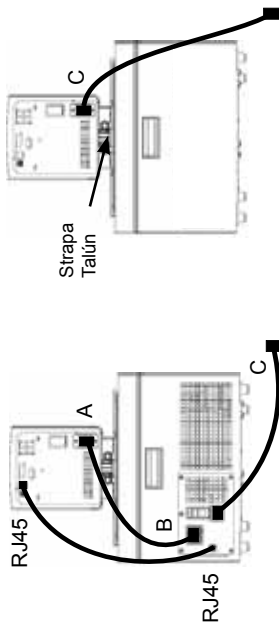



## Osnovne sigurnosne upute Laboratorijska korita

Ako ne razumijete bilo koje od ovih uputa, pogledajte priručnik ili nas kontaktirajte prije nego što nastavite.

**Sigurnost, svi proizvodi:**

 označava neposrednu opasnost koja će, ako se ne izbjegne, uzrokovati smrt ili tešku ozljedu.

 označava moguću opasnu situaciju koja, ako se ne izbjegne, može uzrokovati smrt ili tešku ozljedu.

 označava moguću opasnu situaciju koja, ako se ne izbjegne, može uzrokovati manju ili srednje tešku ozljedu. Također se može koristiti da upozori na nesigurne radnje.

 upozorava korisnika na prisutnost neizoliranog „opasnog napona“ unutar kućišta cirkulatora. Napon je dovoljno velik da predstavlja opasnost od strujnog udara.

 ukazuje na prisutnost vrućih površina.

 ukazuje da je potrebno pročitati priručnik.

 Ova naljepnica označava da se koristi zapaljivo rashladno sredstvo.

Nemojte koristiti korito kao sterilni proizvod ili proizvod povezan na pacijenta. Pored toga, korito nije predviđeno za upotrebu na opasnim lokacijama klase I, II ili III prema definicijama Nacionalnog električnog standarda (engl. National Electrical Code).

Nikad nemojte postavljati korito gdje je prisutna prekomjerna toplina, vlažnost ili nagrizajući materijali. Radni parametri navedeni su u korisničkom priručniku.

Prije pokretanja ostavite hladena korita u uspravnom položaju 24 sata na sobnoj temperaturi (~25 °C). Na ovaj se način osigurava da ulje za podmazivanje istekne nazad u kompresor.

Povežite korito na pravilno uzemljenu utičnicu.

Osigurač koji se nalazi sa stražnje strane korita nije predviđen da se koristi kao uređaj za iskopčavanje.

Koristite cirkulator samo s priloženim kabelom. Ako se kabel za napajanje cirkulatora koristi kao uređaj za iskopčavanje, mora uvijek biti lako dostupan.

Pazite da električni kabeli ne dođu u dodir s vodovodnim priključcima ili cijevima.

Nikad nemojte primjenjivati linijski napon na komunikacijske priključke korita.

Pazite da odabrane cijevi ispunjavaju zahtjeve za maksimalnu temperaturu i tlak.

Pazite da postavite sve električne i, ako postoje, komunikacijske priključke prije pokretanja.

Korištena sredstva za hlađenja teža su od zraka i, ako dođe do curenja, zamijenit će kisik te dovesti do gubitka svijesti. Kontakt sa sredstvom za hlađenje koje curi uzrokuje opekline. Pogledajte natpisnu pločicu cirkulatora za vrstu korištenog sredstva za hlađenje, a zatim potražite dodatne informacije u najnovijem sigurnosno-tehničkom listu za US (engl. Safety Data Sheet; SDS), ranije poznatom kao MSDS, kao i sigurnosno-tehničkom listu za EU.

Provjerite jesu li svi odvodni otvori rezervoara zatvoreni i svi vodovodni priključci pričvršćeni. Također temeljito uklonite sve ostatke prije punjenja.

Da izbjegnute prospanje, postavite spremnike u korito prije punjenja.

Tekućine na bazi ulja se šire prilikom zagrijavanja. Nemojte prepunjavati rezervoar.

Koristite samo odobrene tekućine navedene u priručniku. Korištenje drugih tekućina poništava jamstvo. Nikad nemojte koristiti stopostotni glikol.

Prilikom upotrebe vode preko 80 °C pazljivo pratite razinu tekućine, jer će biti potrebna česta dolijevanja. Također se stvara para.

Smjese voda/glikol zahtijevaju dolijevanje čiste vode, jer će se u suprotnom postotak glikola povećati i dovesti do visoke viskoznosti i slabih performansi.

Prije korištenja bilo koje odobrene tekućine, osim vode, ili prilikom obavljanja postupaka održavanja u kojima će vjerojatno doći do kontakta s tekućinom, pogledajte mjere predostrožnosti prilikom rukovanja u sigurnosno-tehničkom listu proizvođača i EZ sigurnosno-tehničkom listu.

Pazite da tekućina ne može proizvesti nikakve otrovne plinove. Zapaljivi plinovi mogu se nakupiti nad tekućinom tijekom upotrebe.

Prilikom upotrebe etilen glikola i vode redovito provjeravajte koncentraciju tekućine i pH vrijednost. Promjene u koncentraciji i pH vrijednosti mogu utjecati na performanse sustava.

Pazite da prekidna temperaturna točka bude postavljena niže od temperature paljenja za odabranu tekućinu za prijenos topline.

Najviša radna temperatura, prema definicijama standarda EN 61010 (IEC 1010), mora biti ograničena na 25 °C ispod temperature paljenja tekućine korita.

Pazite da tekućina bude na sigurnoj temperaturi (ispod 40 °C) prije rukovanja ili ispuštanja.

Nikad nemojte koristiti oštećenu opremu ili opremu koja propušta, kao ni opremu s oštećenim kabelima.

Nikad nemojte koristiti korito ako u rezervoaru nema tekućine.

Nikad nemojte koristiti korito za dodavanje tekućine u rezervoar sa skinutim pločama.

Nemojte koristiti otapala za čišćenje korita, već koristite meku krpu i vodu.

Ispraznite rezervoar prije prenosa ili pohrane na temperaturama blizu ili ispod točke smrzavanja.

Uvijek isključite korito i iskopčajte napon izvora napajanje iz izvora napajanje prije pomicanja ili obavljanja bilo kakvih postupaka servisiranja ili održavanja. Servisiranje i popravke treba obavljati kvalificirani serviser.

Oprezno prenosite opremu. Naglo drmanje ili ispuštanje opreme može oštetiti njene komponente.

Korisnik je odgovoran za dekontaminaciju ako dođe do prospanja opasnih materijala. Obratite se proizvođaču u vezi s kompatibilnošću sredstava za dekontaminaciju ili čišćenje.

Ako se korito prenosi ili pohranjuje na niskim temperaturama, potrebno ga je isprazniti, a zatim isprati smjesom od 50/50 laboratorijskog glikola/vode.

Stavljanje izvan pogona mora obaviti isključivo kvalificirani trgovac pomoću certificirane opreme. Moraju se slijediti svi važeći propisi.

Obavljanje postupaka ugradnje, korištenja ili održavanja koji nisu opisani u priručniku može dovesti do opasne situacije i poništava jamstvo proizvođača.

Kod korita Sahara i samostalnih potapajućih cirkulatora koristite priloženu maticu i podlošku da pričvrstite sponu za uzemljivanje za vrh metalnog rezervoara.

Nikad nemojte koristiti korito ako je potapajući cirkulator uklonjen.

Nemojte obmuto postavljati potapajući cirkulator; kabel može doći u dodir s tekućinom iz rezervoara.

Prozima akrilna korita i korita od polifenilen oksida se koriste samo s vodom.

Podesite softver korita tako da odgovara korištenoj tekućini.

## Ugradnja cirkulatora korita Arctic, Glacier i Sahara:

Pazite da električni kabeli ne dođu u dodir s vodovodnim priključcima ili cijevima.

Kod hladenih korita postavite priloženi zaštićeni kabel RJ45 između potapajućeg cirkulatora i priključaka za korito RJ45 (sličnih ethernetu). Ovo je obavezno za pravilan rad.

Kod hladenih korita postavite kabel za napajanje od priključka na stražnjoj strani kontrolera, A, do priključka na stražnjoj strani hladnog korita, B. Povežite kabel za napajanje, C, na uzemljenu utičnicu.

Kod hladenih korita nikad nemojte povezivati napojni ulaz, A, na napojni izlaz, C, na uzemljenu utičnicu. Napojni izlaz, B, na bilo što osim potapajućeg cirkulatora.

Kod nehladenih korita povežite kabel za napajanje korita, C, s uzemljenom utičnicom.

Vodovodni priključci za vanjsko cirkuliranje nalaze se sa stražnje strane potapajućeg cirkulatora. ● →

označava povratni protok od vanjskog uređaja. ● → označava izlazni protok ka vanjskom uređaju (strana s koje se vrši snabdijevanje). Priključci imaju vanjski promjer od 16 mm. Skinite matice i ploče da postavite priključke za crijevo od 8 mm ili 12 mm i stezajke koje se isporučuju uz cirkulator.

Kako bi se spriječilo oštećenje vodovoda cirkulatora potrebno je koristiti podešavajući ključ od 19 mm za skidanje/postavljanje priključaka.

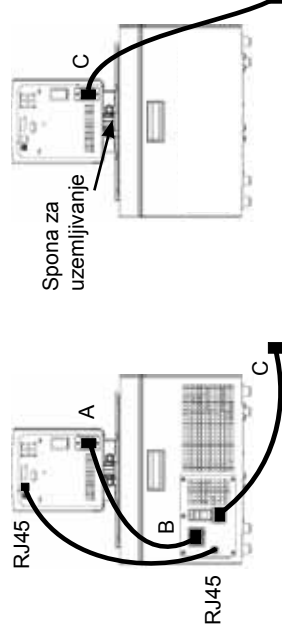

## Alapvető biztonsági utasítások Laboratóriumi fürdők

Ha valamelyik utasítást nem érti, lapozza fel a kézikönyvet, vagy forduljon hozzánk, mielőtt folytatná a munkát.

### Biztonság – összes termék:



Közvetlen veszélyhelyzetet jelez, amely halált vagy súlyos sérülést okoz, ha meg nem előzik.



Potenciálisan veszélyes helyzetet jelez, amely halált vagy súlyos sérülést okoz, ha meg nem előzik.



Potenciálisan veszélyes helyzetet jelez, amely enyhe, vagy közepes sérülést okozhat, ha meg nem előzik. A nem biztonságos eljárásokra is ez a jelzés figyelmeztet.



Veszélyes mértékű, nem szigetelt feszültség jelenlétére figyelmeztet a felhasználót a keringetőszivattyú házában. A feszültség nagysága elég jelentős ahhoz, hogy áramütés veszélyét jelentse.



Forró felületek okozta veszélyre figyelmeztet.



Azt jelzi, hogy el kell olvasni a használati utasítást.



Ez a címke azt jelzi, hogy gyúlékony hűtőközeget használtak.

Ne használja a fürdőt steril vagy beteghez csatlakoztatott eszközként. Továbbá a fürdő nem használható a National Electrical Code szabvány által definiált I., II. vagy III. osztályú veszélyes helyen.

Ne helyezze a fürdőt olyan helyre vagy légkörbe, ahol erős hő, nedvesség vagy korrozív anyagok vannak jelen. Az üzemi paraméterek megtalálhatók a felhasználói kézikönyvben.

A hűtött fürdőket használat előtt 24 órán át tartsa álló helyzetben szobahőmérsékleten (~25 °C). A kenőolaj így vissza tud folyni a kompresszorba.

Csatlakoztassa a fürdőt egy megfelelően földelt csatlakozáaljzathoz.

A fürdő hátulján található áramkörvédő nem használható megszakítóként.

A keringetőszivattyút csak a mellékelt tápkábelrel használja. Ha a keringetőszivattyú tápkábele szolgál megszakítóként, akkor folyamatosan jól hozzáférhetőnek kell lennie.

Biztosítsa, hogy az elektromos vezetékek ne érintkezzenek semmilyen csövel vagy csőcsatlakozással.

Soha ne vezessen hálózati feszültséget a fürdő kommunikációs csatlakozóba.

Olyan csövezeteket használjon, amely megfelel a maximális hőmérséklettel és nyomással kapcsolatos követelményeknek.

Indítás előtt gondoskodjon az összes elektromos – és adott esetben kommunikációs – csatlakoztatásról.

Az alkalmazott hűtőközegek nehezebbek a levegőnél, ezért szivárgás esetén kiszoríthatják az oxigént, ami eszméletvesztést okoz. A szivárgó hűtőközeg a bőrről érintkezve fagyást okoz. A hűtőközeg típusa fel van tüntetve a berendezés adatlábján, további információkat pedig a gyártó legfrissebb amerikai biztonsági adatlapján (SDS, korábbi nevén MSDS) vagy európai biztonsági adatlapján találhat.

Gondoskodjon arról, hogy a tartály valamennyi ürítónyílása zárva legyen, és minden csőcsatlakozás stabil legyen. Feltöltés előtt gondosan távolítsa el minden maradványt.

Töltés előtt a kifolyás megelőzése érdekében helyezze a tartályokat a fürdőbe.

Melegítéskor az olajlapu folyadékok tágulnak. Ne töltse túl a tartályt.

Csak a kézikönyvben szereplő, jóváhagyott folyadékokat használjon. Egyéb folyadékok használata esetén a garancia érvénytelenül válik. Soha ne használjon 100%-os glikolt.

80 °C feletti víz használata esetén gondosan figyelje a folyadékszintet, gyakran lehet szükség utántöltésre. Emellett gőz is keletkezik.

A víz-glikol keverékeket tiszta vízzel kell feltölteni, ellenkező esetben megnövekszik a glikol koncentrációja, nagyobb lesz a viszkozitás, és gyengül a teljesítmény.

Amennyiben nem vízzel van szó, bármilyen jóváhagyott folyadék használata előtt, illetve olyan karbantartás végrehajtásakor, amely várhatóan folyadékkal való érintkezéssel jár, ismerkedjen meg a kezelési óvintézkedésekkel a gyártó által kibocsátott SDS és EK biztonsági adatlappal alapján.

Bizonyosodjon meg arról, hogy a folyadékból nem termelődhet mérgező gáz. A folyadék felett a használat során tűzveszélyes gázok halmozódhatnak fel.

Etilén-glikol és víz használata esetén rendszeres időközönként ellenőrizze a folyadék koncentrációját és pH-értékét. A koncentráció és a pH-érték megváltozása befolyásolhatja a rendszer teljesítményét.

A termikus lekapcsolási pontot az alkalmazott hűtőadó folyadék lobbánáspontjánál kisebb értékre kell állítani.

Az EN 61010 (IEC 1010) meghatározásának megfelelő legmagasabb üzemi hőmérséklet korlátjának 25 °C-kal a fürdőfolyadék lobbánáspontja alatt kell lennie.

A folyadék kezelése vagy leeresztése előtt gondoskodjon arról, hogy az biztonságos hőmérsékletű legyen (40 °C alatt).

Ne üzemeltesse a berendezést, ha az sérült vagy szivárog, illetve ha bármelyik vezetéke sérült.

Ne üzemeltesse a fürdőt anélkül, hogy a tartályban folyadék lenne.

Ha nincs a helyén az összes panel, ne üzemeltesse a fürdőt, és ne töltsön folyadékokat a tartályba.

Ne tisztítsa a fürdőt oldószerrel. Puha rongyot és vizet használjon a tisztításhoz.

Ürítse ki a tartályt, mielőtt a berendezést fagyponthoz szállítaná.

A fűtő mozgatása, illetve szervizelési vagy karbantartási eljárás végrehajtása előtt mindig kapcsolja ki és válassza le az áramforrásról a berendezést. A szervizelést és a javítást bízza képzett szakemberrel.

A fűtő szállításkor legyen óvatos. A zökkenések vagy leejtés kárt tehet a berendezés komponenseiben.

Veszélyes anyag kifolyása esetén a dekontaminálás a felhasználó felelőssége. A dekontaminálást, illetve a tisztítószerek kompatibilitását illetően forduljon a gyártóhoz.

Alacsony hőmérsékleten történő szállításhoz vagy tároláshoz a fűtőt le kell üríteni, majd laboratóriumi minőségű glikol és víz 50-50 százalékos keverékével ki kell öblíteni.

Az üzemmen kívüli helyezést csak szakkereskedő hajthatja végre, minősített berendezés használatával.

Minden érvényben lévő előírást be kell tartani.

A telepítési, üzemeltetési, illetve karbantartási eljárásoknak a kézikönyvben foglaltól eltérő végrehajtása veszélyes helyzetet teremthet, és érvénytelené teszi a gyártó garanciáját.

Sahara fűtő és különálló merülő keringetőszivattyú esetén a mellékelt anya és alátét segítségével rögzítse a testvezeték a fémtartály tetejéhez.

Eltávolított merülő keringetőszivattyúval ne üzemeltesse a fűtőt.

Ne szerelje be a merülő keringetőszivattyút megfordítva, mert a tápkábel hozzáérhet a tartály folyadékához.

Az átlátszó akril- és polipropilén-oxid (PPO) fűtők csak vízzel használhatók.

A fűtő szoftverét állítsa be a használt folyadékknak megfelelően.

## Telepítés Arctic, Glacier és Sahara fűtőkeringetők esetében:



Biztosítsa, hogy az elektromos vezetékek ne kerüljenek érintkezésbe semmilyen csővel vagy csőcsatlakozással.

Hűtőt fűtő esetében telepítse a mellékelt RJ45-ös ármékolt kábelt a merülő keringetőszivattyú és a fűtő RJ45-ös csatlakozói (Ethernethoz hasonló) közé. Erre szükség van a megfelelő működéshez.

Hűtőt fűtő esetében telepítse a tápkábelt a vezérlő hátulján található A csatlakozó és a hűtőt fűtő hátulján található B csatlakozó közé. Csatlakoztassa a fűtő C tápkábelét egy földelt csatlakozóaljzathoz.

Hűtőt fűtő esetében soha ne csatlakoztassa tápkimenethez a vezérlő A tápbemenetét. A B tápkimenetet kizárólag a merülő keringetőszivattyúhoz szabad csatlakoztatni.

Nem hűtőt fűtő esetében csatlakoztassa a fűtő C tápkábelét egy földelt csatlakozóaljzathoz.

A külső keringetés csőcsatlakozásai a merülő keringetőszivattyú hátulján találhatók.  : visszáram a külső alkalmazásból.  : kimeneti áram a külső alkalmazásba. A csatlakozások külső átmérője 16 mm. Távolítsa el hollandi anyákat és a lemezeket, majd telepítse a keringetőszivattyúhoz mellékelt 8 vagy 12 mm-es tömlőcsonkokat és -billincseket.

A keringetőszivattyú csővezetéke sérülésének megelőzése érdekében 19 mm-es racsni kulccsal távolítsa el, illetve telepítse a csatlakozásokat.

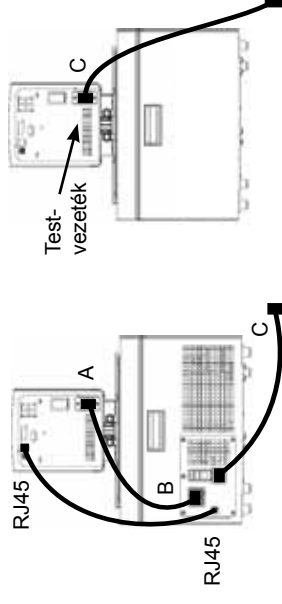



## Pagrindinės saugos instrukcijos Laboratorinės vonelės

Jei kurios nors iš šių instrukcijų yra nesuprantamos, prieš tęsdami skaitykite vadovą arba kreipkitės į mus.

### Sauga, visi gaminiai:

**DANGER** nurodo neišvengiamai pavojingą situaciją, kurios neišvengus, galima mirties arba rimto sužalojimo baigtis.

**WARNING** nurodo galimai pavojingą situaciją, kurios neišvengus, galima mirties arba rimto sužalojimo baigtis.

**CAUTION** nurodo galimai pavojingą situaciją, kurios neišvengus, kyla neimto arba vidutinio sužalojimo tikimybė. Taip pat galima pranešti, kai yra naudojama nesaugiai.

 skirta pranešti naudotojui, kai prie cirkuliatoriaus yra neizoliuota „pavojinga įtampa“. Įtampos dydis yra gana svarbus ir gali sukelti elektros šoko pavojų.

 nurodo esamus karštus paviršius.

 nurodo skaityti vadovą.

 Ši etiketė nurodo, kad naudojamas degus aušalas.

Nenaudokite vonelės kaip steriliaus ar prie paciento prijungto prietaiso. Be to, vonelė nėra skirtas naudoti I, II ir III klasės pavojingose vietose, kaip nurodyta Nacionaliniame elektros kodekse.

Niekada nedėkite vonelės vietoje ar ore, kur yra per didelis karštis, drėgmė ar korozinės medžiagos. Darbinių parametrijų ieškokite naudotojo vadove.

Prieš įjungdami 24 valandoms palikite atšaldytas vonelės vertikalioje padėtyje kambario temperatūroje (~25 °C). Taip suteptimo alyva suteka atgal į kompresorių.

Prijunkite vonelę prie tinkamai įžeminto išvado.

Grandinės saugiklis vonelės užpakalinėje dalyje yra skirtas atjungimui.

Įjunkite cirkuliatorių tik su tiekiamu linijos laidu. Jei cirkuliatoriaus maitinimo laidas yra naudojamas kaip atjungimo prietaisas, jį būtina lengvai pasiekti visuomet.

Užtikrinkite, kad elektros laidai nesiliestų su kanalizacijos jungtimis ar vamzdynu.

Niekada nejunkite linijos įtampos prie bet kurių vonelės komunikacinių jungčių.

Užtikrinkite, kad jūsų pasirinktas vamzdynas atitinka jūsų didžiausios temperatūros ir slėgio reikalavimus. Užtikrinkite, kad visos elektros, ir jei yra, komunikacijos jungtys yra sujungtos prieš paleidžiant.

Naudojami aušalai yra sunkesni nei oras ir, esant nutekėjimui, jie išstums deguonį, dėl ko galima prarasti sąmonę. Prisilietus prie ištekėjusių aušalų, galima nudegti odą. Naudojamo aušalo tipo ir gamintojo naujausios JAV saugumo duomenų išklotinės (SDS), anksčiau žinomos kaip MSDS bei ES saugumo duomenų išklotinės papildomos informacijos ieškokite cirkuliatoriaus techninių duomenų lentelės.

Užtikrinkite, kad visi rezervuaro drenažo prievadai yra uždaryti ir visos kanalizacijos jungtys yra apsaugotos. Taip pat užtikrinkite, kad bet prieš pildant būtų nuvalytos visos nuosėdos.

Vengdami išsiliejimo, prieš pilddami padėkite savo konteinerius į vonelę. Išilę skysčiai allejaus pagrindu plečiasi. Venkite rezervuaro perpildymo.

Naudokite tik vadove išvardintus patvirtintus skysčius. Kitų skysčių panaudojimas panaikina garantiją. Niekada nenaudokite 100 % glikolio.

Naudodami aukštesnės nei 80 °C temperatūros vandenį, atidžiai stebėkite skysčio lygį, reikės dažnai papildyti. Jis taip pat garuoja.

Vandens / glikolio mišiniams reikės papildymo grynu vandeniu, kitaip glikolio koncentracija kils ir didės klampa bei prastės veikimas.

Be vandens, prieš naudodami kitą patvirtintą skystį arba atlikdami priežiūrą, kur galimas kontaktas su skysčiu, tvarkymo atsargumo priemonių ieškokite gaminto SDS ir EB saugos duomenų išklotinė.

Užtikrinkite, kad skystis negarins toksinių dujų. Naudojimo metu virš skysčio gali susikaupti degios dujos. Naudodami etileno glikolį ir vandenį, reguliariai tikrinkite skysčio koncentraciją ir pH. Koncentracijos ir pH pakitimai gali turėti įtakos sistemos veikimui.

Užtikrinkite, kad per didelės temperatūros atkirtimo taškas yra nustatytas žemiau nei pasirinkto karščio perdavimo skysčio degimo taško.

Aukščiausia darbinė temperatūra, kaip apibrėžta EN 61010 (IEC 1010), turi būti ribojama 25 °C žemiau vonelės skysčio degimo taško.

Prieš tvarkydami ar išpildami, užtikrinkite, kad skystis yra saugioje temperatūroje (žemiau 40 °C).

Niekada nenaudokite pažeistos ar pratekančios įrangos arba pažeistų laidų.

Niekada nenaudokite vonelės be skysčio rezervuare.

Niekada nenaudokite vonelės ir nepilkite skysčio į rezervuarą su nuimtais skydeliais.

Nevalykite vonelės tirpikliais, naudokite minkštą medžiagą ir vandenį.

Ištušinkite rezervuarą prieš transportuodami ir / arba sandėliuodami atimimo užšalimui ar žemesnėje temperatūroje.

Visada išjunkite vonelę ir atjunkite maitinimo įtampą nuo jos elektros šaltinio prieš perkeldami ir prieš atlikdami bet kokias aptarnavimo ar priežiūros procedūras. Aptarnavimo ir remonto kreipkitės į kvalifikuotą techniką.

Vonelę transportuokite atsargiai. Staigūs krestelėjimai arba kritimai gali pažeisti jos komponentus.

Naudotojas yra atsakingas už išvalymą, jei išsilieja pavojingos medžiagos. Dėl išvalymo ir / arba valiklių suderinamumo kreipkitės į gamintoją.

Jei vonelė yra transportuojam ir / arba saugoma žemoje temperatūroje, ją reikia išiešti ir praskalauti 50/50 laboratorijoje sumaišytą glikolio / vandens mišinį.

Eksploatacijos nutraukimą turi atlikti tik kvalifikuotas pardavėjas, naudojantis sertifikuotą įrangą. Reikia laikytis visų galiojančių nuostatų.

Kitokių įrengimo, naudojimo ir priežiūros procedūrų nei nurodyta vadove gali sukelti pavojingą situaciją ir anuliuoja gamintojo garantiją.

„Sahara“ vonelėms ir atskiriems panardinamiems cirkulatoriams įžeminimo juostai pritvirtinti prie metalinio bako viršaus naudokite tiekiamą veržlę ir poveržlę.

Niekada nenaudokite vonelių su nuimtu panardinamuoju cirkulatoriumi.

Neuždėkite panardinamojo cirkulatoriaus atvirkščiai, linijos laidas gali prisiliesti prie rezervuaro skysčio.

Permatomos akrilo ar polifenileno oksido (PPO) vonelės yra naudojamos tik su vandeniu.

Reguluokite vonelės programinę įrangą, kad ji atitiktų naudojamą skystį.

## „Arctic“, „Glacier“ ir „Sahara“ vonelių cirkulatorių įrengimas:

Užtikrinkite, kad elektros laidai nesiliestų su kanalizacijos jungtimis ar vamzdžiu.

Atšaldytoms vonelėms įkiškite tiekiamą RJ45 ekranuotą kabelį tarp panardinamojo cirkulatoriaus ir vonelės RJ45 jungčių (panašiai kaip Ethernet). To reikia tinkamam veikimui.

Atšaldytoms vonelėms įstatykite elektros laidą iš jungties valdiklio gale, A, į jungtį atšaldytos vonelės gale, B. Prijunkite vonelės elektros laidą, C, į žemintą elektros išvadą.

Atšaldytoms vonelėms niekada neprijunkite valdiklio elektros įvado, A, prie elektros išvado. Elektros išvado, B, neprijunginėkite prie nieko kito, išskyrus panardinamąjį cirkulatorių.

Neatšaldytoms vonelėms prijunkite vonelės elektros laidą, C, prie žeminto elektros išvado.

Kanalizacijos jungtis išorinei cirkuliacijai yra panardinamojo cirkulatoriaus užpakalinėje dalyje. ➔ ● yra atgalinė išorinio pritaikymo tėkmė. ● ➔ yra išvado į išorinį tiekimą (tiekimo pusę) tėkmė. Jungtys yra 16 mm išor. skersm. Nuimkite sujungimo veržlės ir plokšteles, kad galėtumėte įrengti 8 mm arba 12 mm žarnelės užkarpas bei grybtus, tiekiamus kartu su cirkulatoriumi.

Kad išvengtų cirkulatoriaus kanalizacijos sugadinimo, naudokite 19 mm atraminį raktą jungtims nuimti / uždėti.

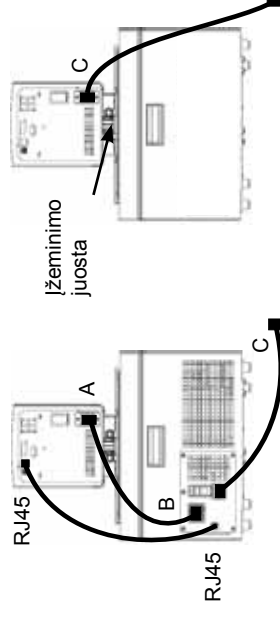





# Būtiskas drošības instrukcijas Laboratorijas vannas

Ja kāda no šīm instrukcijām nav saprotama, pirms turpināt darbu, skatiet rokasgrāmatu vai sazinieties ar mums.

## Drošības apzīmējumi (attiecas uz visiem izstrādājumiem)



Norāda uz nopietnu apdraudējumu, kas var izraisīt nāvi vai nopietnas traumas, ja netiek novērsta.



Norāda uz potenciāli bīstamu situāciju, kas var izraisīt nāvi vai nopietnas traumas, ja netiek novērsta.



Norāda uz potenciāli bīstamu situāciju, kas var izraisīt vieglas vai mērenas traumas, ja netiek novērsta. Šis apzīmējums arī tiek izmantots, lai brīdinātu par nedrošu rīcību.



Brīdina lietotāju par neizolēta bīstama sprieguma klātbūtni cirkulatora korpusā. Spriegums ir pietiekami augsts, lai radītu elektrotrieciena saņemšanas risku.



Norāda uz karstu virsmu klātbūtni.



Norādījums lasīt rokasgrāmatu.



Šī etiķete norāda, ka tiek izmantots uzliesmojošs aukstumnesējs.

Neizmantojiet vannu kā sterilu vai ar pacientu saistītu ierīci. Turklāt vanna nav paredzēta lietošanai I, II vai III klases bīstamās zonās atbilstoši ASV Nacionālās elektrotehnikas standartu sistēmas prasībām.

Vannu nekādā gadījumā nedrīkst novietot vietā vai vidē, kur pastāv pārmērīga karstuma, mitruma vai korozīvu vielu klātbūtne. Eksploataācijas parametrus skatiet lietotāja rokasgrāmatā.

Pirms iedarbināšanas dzesēšanas vannām jāatrodas vertikālā pozīcijā istabas temperatūrā (~25 °C) 24 stundu ilgumā. Tādējādi tiek nodrošināta eļļošanas eļļas atplūde kompresorā.

Pieslēdziet vannu atbilstoši saņemtai kontaktligzdai.

Vannas aizmugurē izvietotā kontūra aizsargierīce nav paredzēta izmantošanai kā atvienošanas ierīce.

Cirkulatora ekspluatācijai izmantojiet tikai komplektā iekļauto barošanas vadu. Ja cirkulatora barošanas vads tiek izmantots kā atvienošanas ierīce, tam jābūt vienmēr pieejamam.

Nodrošiniet, lai elektriskie vadi nesaskartos ar cauruļu savienojumiem un caurulēm.

Nekādā gadījumā nepievienojiet līnijas spriegumu vannas sakaru savienojumiem.

Nodrošiniet, lai izvēlētās caurules atbilstu maksimālās temperatūras un spiediena prasībām.

Nodrošiniet, lai pirms iekārtas iedarbināšanas būtu izveidoti visi elektriskie un, ja nepieciešams, sakaru savienojumi.

Izmantojie aukstumagēnti ir smagāki par gaisu un noplūdes gadījumā izspiedīs skābekli, izraisot samaņas zudumu. Nonākot saskarē ar noplūdušu aukstumagēntu, rodas ādas apdegumi. Izmantojamā aukstumagēnta veidu skatiet uz cirkulatora nominālvērtību plāksnītes, savukārt papildinformāciju skatiet jaunākajā ražotāja nodrošinātajā ASV drošības datu lapā (SDS) (kādreizējā MSDS), kā arī ES drošības datu lapā.

Nodrošiniet, lai visas rezervuāra iztukšošanas pieslēgvietas būtu noslēgtas un visi cauruļu savienojumi būtu droši. Kā arī nodrošiniet, lai pirms uzpildes būtu rūpīgi izvērtīti visi atlikumi.

Lai novērstu izšļakstīšanos, konteinerus pirms uzpildes ievietojiet vannā.

Nekādā gadījumā nedarbiniēt vannu, ja rezervuārā nav šķidruma.

Šķidrums uz eļļas bāzes karstuma ietekmē izplešas. Izvairieties no rezervuāra pārpildīšanas.

Izmantojiet tikai apstiprinātos šķidrumus, kas norādīti rokasgrāmatā. Citi šķidrums lietošanas gadījumā tiek anulēta garantija. Nekādā gadījumā nelietojiet 00% glikolu.

Ja tiek izmantots ūdens ar temperatūru virs 80 °C, rūpīgi pārtrauciet šķidruma līmeni, jo būs nepieciešama regulāra tā papildināšana. Tādējādi arī tiek radīts tvaiks.

Ūdens/glikola maisījumu līmeņa papildināšana jāveic ar tīru ūdeni, jo pretējā gadījumā pieaugs glikola īpatsvars maisījumā, izraisot ļoti augstu viskozitātes līmeni un neapmierinošu veiktspēju.

Ja tiek izmantots jebkāds apstiprināts šķidrums, izņemot ūdeni, vai tiek veikti apkopes darbi, kuru laikā iespējams nonākt saskarē ar šķidrumu, skatiet uz apiešanas ar šo šķidrumu attiecināmos drošības pasākumus ražotāja nodrošinātajās SDS un EK drošības datu lapās.

Nodrošiniet, lai šķidrums neradītu toksiskas gāzes. Šķidrums lietošanas laikā virs tā var veidoties viegli uzliesmojošas gāzes.

Ja tiek izmantots etilēnglikols un ūdens, regulāri pārbaudiet šķidrums koncentrāciju un pH līmeni.

Koncentrācijas un pH līmeņa izmaiņas var ietekmēt sistēmas veiktspēju.

Nodrošiniet, lai iestatītā pārmērīgas temperatūras atslēgšanas punkta vērtība būtu zemāka par izmantojamā siltumpārmese šķidrums uzliesmošanas temperatūru.

Augstākās darba temperatūras ierobežojumam, kā tas definēts standartā EN 61010 (IEC 1010), jābūt 25 °C zem vannas šķidrums uzliesmošanas temperatūras.

Pirms apiešanās ar šķidrumu vai tā iztukšošanas nodrošiniet, lai tā temperatūra būtu droša (zem 40 °C).

Nekādā gadījumā nedarbiniēt aprīkojumu, ja tas ir bojāts vai tam ir sūce, vai arī barošanas vads ir bojāts.

Nekādā gadījumā nedarbiniēt vannu, ja rezervuārā nav šķidrums.

Nekādā gadījumā nedarbiniēt vannu un nepievienojiet šķidrums rezervuārā, ja paneļi ir noņemti.

Vannas tīrīšanai nedrīkst izmantot šķīdinātājus; tīrīšanu var veikt, lietojot mīkstu drāniņu un ūdeni.

Iztukšojiet rezervuāru pirms tā transportēšanas un/vai uzglabāšanas apstākļos, kad temperatūra ir tuvu sasaldēšanas temperatūrai vai zem tās.

Pirms pārvietošanas vai jebkādu apkalpošanas vai apkopes procedūru veikšanas vienmēr izslēdziet vannu un atvienojiet to no elektroapgādes tīkla. Apkalpošanu un remontu drīkst veikt tikai atbilstoši kvalificēti tehniskie speciālisti.

Transportējot vannu, ievērojiet piesardzību. Pēkšņi satricinājumi vai krišana var sabojāt tā sastāvdaļas.

Ja notiek bīstamu materiālu noplūde, lietotājs ir atbildīgs par dekontamināciju. Lai saņemtu informāciju par dekontamināciju un/vai tīrīšanas līdzekļu saderību, vērsieties pie ražotāja.

Ja vannu paredzēts transportēt un/vai uzglabāt zemas temperatūras klātbūtnē, tā ir jāiztukšo un jāizskalo ar lietošanai laboratorijā piemērotu glikola/ūdens maisījumu (50/50).

Izņemšanu no ekspluatācijas drīkst veikt tikai attiecīgi kvalificēts izplatītājs, izmantojot sertificētu aprīkojumu. Ir jāievēro visu piemērojamo likumdošanas aktu prasības.

Ja tiek veiktas uzstādīšanas, ekspluatācijas vai apkopes procedūras, kas atšķiras no šajā rokasgrāmatā aprakstītajām, var rasties bīstamas situācijas un tiek anulēta ražotāja garantija.

Sahara vannām un autonomajiem iegremdēšanas cirkulatoriem ir jāizmanto komplektā iekļautais uzgrieznis un paplāksne, lai piesprīnātu zemējuma lenti metāla tvertnes augšpusē.

Nekādā gadījumā nedarbiniet vannu, ja ir noņemts iegremdēšanas cirkulators.

Iegremdēšanas cirkulatoru nedrīkst uzstādīt otrādi, jo šādā gadījumā barošanas vads var nonākt saskarē ar rezervuāra šķidrumu.

Caurspīdīgās akrila un polifenilēna oksīda (PPO) vannas ir paredzētas izmantošanai tikai ar ūdeni.

Pielāgojiet vannas programmatūru atbilstoši izmantojamajam šķidrumam.

## Arctic, Glacier un Sahar cirkulācijas vannu uzstādīšana

Nodrošiniet, lai elektriskie vadi nesaskartos ar cauruļu savienojumiem un caurulēm.

Dzesēšanas vannām uzstādiet komplektā iekļauto RJ45 ekranēto kabeli starp iegremdēšanas cirkulatoru un vannas RJ45 savienotājiem (Izdzīgi Ethernet savienojumiem). Tas ir nepieciešams, lai nodrošinātu pareizu darbību.

Dzesēšanas vannām uzstādiet barošanas vadu no savienotāja kontrolera aizmugurē (A) uz savienotāju dzesēšanas vannas aizmugurē (B). Pievienojiet vannas barošanas vadu (C) sazemētai kontaktligzdai.

Dzesēšanas vannām nekādā gadījumā nesavienojiet kontrolera barošanas ieeju (A) ar barošanas kontaktligzdu. Barošanas kontaktligzdu (B) drīkst savienot tikai ar iegremdēšanas cirkulatoru.

Vannām bez dzesēšanas savienojiet vannas barošanas vadu (C) ar sazemētu barošanas kontaktligzdu.

Cauruļu savienojumi ārējai cirkulācijai atrodas iegremdēšanas cirkulatora aizmugurē. → ir aplūdes plūsma no ārējās ierīces. ● → ir izplūdes plūsma uz ārējo ierīci (padeves puse). Savienojumi ir 16 mm O.D. Noņemiet savienotājuuzmavas un paplāksnes, lai uzstādītu 8 mm vai 12 mm šūteņu iemavas un apskavas, kas iekļautas komplektā ar cirkulatoru.

Lai neizraisītu cirkulatora cauruļu savienojumu bojājumus, savienojumu demontāžai/uzstādīšanai izmantojiet 19 mm uzmaucamo atslēgu ar fiksatoru.

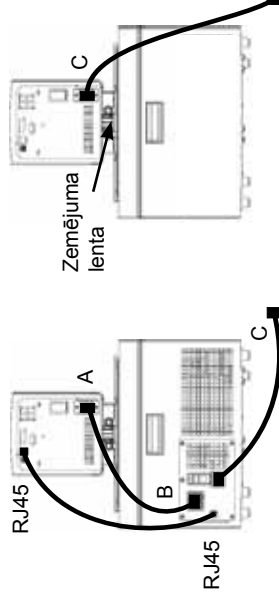

# Istruzzjonijiet Essenzjali tas-Sigurtà Laboratory Baths

Jekk xi waħda minn dawn l-istruzzjonijiet ma tinfi hemx, irreferi għall-manwal jew ikkuntattjana qabel ma tipproċedi.

## Sigurtà: il-prodotti kollha:

**DANGER** jindika sitwazzjoni perikoluża b'mod imminenti, li jekk ma tiġix evitata, se tirriżulta f'mewt jew f'korrimment serju.

**WARNING** jindika sitwazzjoni potenzjalment perikoluża, li jekk ma tiġix evitata, tista' tirriżulta f'mewt jew f'korrimment serju.

**CAUTION** jindika sitwazzjoni potenzjalment perikoluża, li jekk ma tiġix evitata, tista' tirriżulta f'korrimment żgħir jew moderat. Jista' jintuża wkoll biex iwissi kontra prattici li mhumiex siguri.

 intenzjonat biex iwissi lili-utent dwar il-preżenza ta' "vultaġġ perikoluż" mhux insulat fi-enclosure ta-chiller. Il-qawwa tal-vultaġġ hi sinifikanti biżżejjed biex tikkostitwixxi riskju ta' xokk elettriku.

 jindika l-preżenza ta' wuħuh jaharqu.

 jindika biex dak li jkun jaqra l-manwal.

 Din it-tikketta tindika li jintuża refrigerant fjamabbli.

Tużax il-banju bhala tagħmir sterili jew tagħmir li jiġi kkonnettjat mal-pazjent. Barra minn hekk, il-banju mhuiwix maħsub għall-użu f'Posizzjonijiet Perikolużi ta' Klassi I. Il-jew III kif definit min-National Electrical Code. Qatt m'għandek ipoggi l-banju f'post jew atmosfera fejn ikun hemm shana eċċessiva, umdi, jew materjali korrużivi. Irreferi għall-manwal tal-utent għall-parametri tal-operat.

Falli r-refrigerated baths f'pożizzjoni wieqfa fit-temperatura tal-kamra (~25°C) għal 24 siegħa qabel ma tiqgħelhom. Dan jiżgura li ż-żejt tal-lubrikazzjoni jkun mar lura fil-kompressor.

Ikkonnettja l-banju ma' outlet li jkun erjat kif support.

Is-circuit protector li jinsab fuq in-naħa ta' wara tal-banju, mhuiwix intenzjonat biex jagixxi bhala tagħmir ta' skonetttjar.

Faddem is-circulator billi tuża l-line cord fornuta biss. Jekk is-circulator power cord tintuża bhala tagħmir ta' skonetttjar, trid tkun aċċessibbli faċilment il-hin kollu.

Żgura li l-electrical cords ma jkunu jmissu ma' kwalunkwe konnessjonijiet tal-plumbing jew tubing.

Qatt m'għandek tapplika line voltage ma' kwalunkwe waħda mill-konnessjonijiet tal-komunikazzjoni tal-banju.

Aċċerta ruhek li t-tubing li tagħzel ikun jissodisfa r-rekwiżiti tat-temperatura massima u pressjoni massima tiegħek.

Kun żgur li l-konnessjonijiet elettrici kollha u, jekk applikabbli, il-konnessjonijiet tal-komunikazzjoni, ikunu saru qabel ma tiqgħel it-tagħmir.

Ir-refrigerants użati huma itqal mill-arja u, jekk ikun hemm tniixxa, se jissostitwixxu l-ossġnu u jikkawżaw li wieħed jimitief minn sensih. Kuntatt ma' refrigerant li jkun qed inixxi se jikkawża ħnuq tal-ġilda. Irreferi għas-circulator nameplate għat-tip ta' refrigerant użat u mbagħad għal US Safety Data Sheet (SDS) l-aktar riċenti tal-manifattur, li qabel kienet magħrufa bhala MSDS, u l-EU Safety Data Sheet għal informazzjoni addizzjonali.

Aċċerta ruhek li r-reservoir drain ports kollha jkunu magħluqin u l-konnessjonijiet kollha tal-plumbing ikunu siguri. Żgura wkoll li tneħħi bir-reġa kwalunkwe residwu qabel ma timla.

Blex tevita t-tixrid, poġġi l-kontenituri tiegħek fil-banju qabel ma timla.

Qatt m'għandek tħaddem il-banju mingħajr fluwidu fir-reservoir.

Fluvidi bbażati fuq iż-zejt jespandu meta jissafħnu. Evita li timla zżejjed ir-reservoir.

Uża biss il-fluvidi approvati li huma elenkati fil-manwal. Li tuża fluwidu oħrajn, se jikkawża li l-garanzija ma tibqax valida. Qatt m'għandek tuża 100% glycol.

Meta tuża ilma b'temperatura ta' aktar minn 80°C, immonitorja mill-qrib il-livell tal-fluwidu; top-offs frekwenti se jkunu meħtieġa. Johloq ukoll il-fwair.

Taħlittiet ta' ilma/glycol jehieġu top-offs b'ilma pur, inkella, l-percentwali ta' glycol se tizidied u tirriżulta f'viskożità għolja u prestazzjoni batuta.

Minbarra l-ilma, qabel ma tuża kwalunkwe fluwidu approvat, jew meta tagħmel xi manutenzjoni fejn x'aktarx li se jkollok kuntatt mal-fluwidu, irreferi għall-SDS jew I-EC Safety Data Sheet tal-manifattur għall-prekawzjonijiet tal-immaniġġjar.

Kun żgur li l-ebda gassijiet tossiċi ma jiġu oġġenerati mill-fluwidu. Gassijiet li jistgħu jehdu n-nar jistgħu jakkumulaw fuq il-likwidu matul l-użu.

Meta tuża l-ethylene glycol u ilma, iċċekkja l-koncentrazzjoni tal-fluwidu u l-pH fuq bażi regolari. Bidliet fil-koncentrazzjoni u fil-pH jista' jkollhom impatt fuq il-prestazzjoni tas-sistema.

Aċċerta ruhek li l-over temperature cut-off point ikun issettjat iktar baxx mill-fire point għall-heat transfer fluid li jkun intgħazel.

L-oġġha temperatura tal-operat, kif definita mill-EN 61010 (IEC 1010), trid tkun limitata għal 25°C taħt il-fire point tal-fluwidu tal-banju.

Kun żgur li l-fluwidu jkun f'temperatura sigura (inqas minn 40°C) qabel ma timmaniġġjah jew tbatlu.

Qatt m'għandek tħaddem tagħmir bil-hsara jew li jkun qed inixxi, jew li jkollu xi power cords bil-hsara.

Qatt m'għandek tħaddem il-banju mingħajr fluwidu fir-reservoir.

Qatt m'għandek tħaddem il-banju jew iżzid il-fluwidu fir-reservoir bil-panels imneħħija.

Tnaddafx il-banju bis-solventi; uża biċċa drapp ratba u ilma.

Battal ir-reservoir qabel ma jiġi ttrasportat, u/jew jinnaħżen qrib jew taħt temperaturi taħt iż-żero.

Dejjem tiffi l-banju u skonetttja l-provvista tal-vultaġġ minn sors tal-provvista tad-dawl tiegħu qabel ma tċaqliqu jew qabel ma twestaq kwalunkwe proċeduri ta' servicing jew manutenzjoni. Irreferi s-service u t-tiswijiet lili-technician ikkwalfikat.

Itrrasporta l-banju b'attenzjoni. Skossi għall-għarrieda jew li twaqqa' t-tagħmir, jistgħu jaġġmlu hsara lili-komponenti tiegħu.

L-utent hu responsabbli għad-dekontaminazzjoni jekk materjali perikolużi jinxtardu. Ikkonsulta l-manifattur dwar il-kompatibilità tad-dekontaminazzjoni jew ta' sustanzi taħt-ilmid.

Jekk il-banju jkun se jiġi ttrasportat u/jew jinħażen f'temperaturi keshin, jeħtieġ li jibattal u mbagħad jiġlahlah b'taħlita ta' 50/50 laboratory grade glycol/wiema.

Id-dekomijsjonar irid isir biss minn agent ikkwalfikat bi-użu ta' tagħmir iċċertifikat. Ir-regolamenti prevalenti kollha jridu jiġu segwiti.

Il-prestazzjoni tal-proċeduri tal-installazzjoni, operat, jew manutenzjoni, hielief dawk deskritti fil-manwal, jistgħu jirriżultaw f'sitwazzjoni penikoluża, u dan se jhassar il-garanzija tal-manifattur.

Għal Sahara baths, u stand-alone immersion circulators, uża l-iskorfina u l-washer ipprovduti biex twaħħal il-grounding strap man-naħa ta' fuq tat-tank tal-metall.

Qatt m'għandek fhaddem il-banju bi-immersion circulator imnefhi.

Timmuntax l-immersion circulator bil-maqlob, il-line cord lista t'miss mal-fluwidu fir-reservoir.

Transparent Acrylic u Polyphenylene oxide (PPO) Baths jintużaw mal-lima biss.

Aggusta s-software tal-banju biex ikun jaqbel mal-likwidu użat.

## Installazzjoni għal Arctic, Glacier and Sahara Bath Circulators:

Żgura li l-electrical cords ma jkunux imissu ma' kwalunkwe konnessjonijiet tal-plumbing jew tubing.

Għal refrigerated baths, installa l-RJ45 shielded cable ipprovdut bejn l-immersion circulator u l-bath RJ45 connectors (simili għal Ethernet). Dan hu meħtieġ għal operat kif suppost.

Għal refrigerated baths, installa l-power cord mill-connector fuq in-naħa ta' wara tal-controller, A, mal-connector fuq in-naħa ta' wara tar-refrigerated bath, B. Ikkonnettja l-power cord tal-banju, C, ma' grounded power outlet.

Għal refrigerated baths, qatt m'għandek tikkonnettja controller power inlet, A, ma' power outlet. Qatt m'għandek tikkonnettja power outlet, B, ma' kwalunkwe haġa hliet immersion circulator.

Għal non-refrigerated baths, ikkonnettja l-power cord tal-banju, C, ma' grounded power outlet.

Il-konnessjonijiet tal-plumbing għaċ-ċirkolazzjoni esterna jinsabu fuq in-naħa ta' wara tal-immersion circulator. → hu r-return flow għaċ-ċirkolazzjoni esterna. ● hu l-outlet flow għall-applikazzjoni esterna (supply side). Il-konnessjonijiet huma 16 mm O.D. Neffhi l-union nuts u l-plates biex tinstalla l-8 mm jew 12 mm hose barbs u clamps fornuti mas-circulator.

Biex tipprevjeni li tagħmel hsara lill-plumbing tas-circulator, uża 19 mm backing wrench meta tnefhi/tinstalla l-konnessjonijiet.

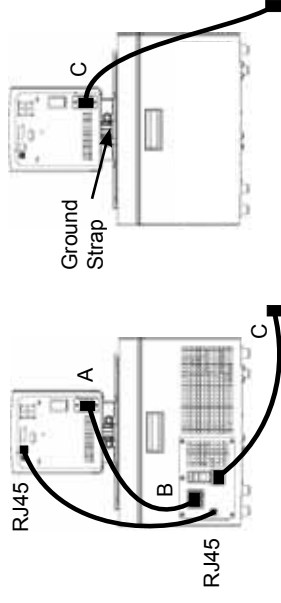

## Ważne instrukcje dotyczące bezpieczeństwa Wanny laboratoryjne

W przypadku niezrozumienia którychkolwiek z niniejszych instrukcji, przed przystąpieniem do dalszych prac należy zapoznać się z instrukcją obsługi lub skontaktować się z nami.

### Bezpieczeństwo, wszystkie produkty:

**DANGER** wskazuje na sytuację bezpośredniego zagrożenia, która bez podjęcia środków zaradczych doprowadzi do śmierci lub poważnych obrażeń ciała.

**WARNING** wskazuje na sytuację potencjalnie niebezpieczną, która bez podjęcia środków zaradczych może doprowadzić do śmierci lub poważnych obrażeń ciała.

**CAUTION** wskazuje na sytuację potencjalnie niebezpieczną, która bez podjęcia środków zaradczych doprowadzi do drobnych lub umiarkowanych obrażeń ciała. Ponadto będzie wykorzystywana do zgłaszania niebezpiecznych zachowań.

 ostrzega użytkownika o niezaizolowanym "niebezpiecznym napięciu" w obrębie obudowy cyrkulatora. Wartość bezwzględna napięcia jest na tyle wysoka, by nieść za sobą ryzyko porażenia prądem elektrycznym.

 ostrzega przed gorącymi powierzchniami.

 nakazuje przeczytać instrukcję obsługi.

 Etykieta ta wskazuje, że stosuje się czynnik chłodniczy łatwopalny.

Nie używać wanny, jako urządzenia sterylnego ani mającego kontakt z pacjentem. Ponadto wanna nie jest przeznaczona do zastosowań w obrębie Lokalizacji Niebezpiecznych, Klasy I, II lub III określonych przez Krajowe Normy Elektryczne.

Nigdy nie umieszczaj wanny w miejscu bądź w atmosferze, gdzie wystawiona będzie na działanie zbyt wysokich temperatur, wilgoci lub materiałów powodujących korozję. Aby zapoznać się z parametrami roboczymi, patrz instrukcja użytkownika.

Przed uruchomieniem wanny chłodnicze pozostawić w pozycji pionowej w temperaturze pokojowej (~25°C) przez okres 24 godzin. Dzięki temu olej smarowy spłynie z powrotem do sprężarki.

Wannę podłączyć do odpowiednio uzziemionego gniazdka.

Ochronnika obwodu znajdującego się w tylnej części wanny nie należy używać jako urządzenia odłączającego.

Cyrkulator należy obsługiwać wyłącznie z wykorzystaniem dostarczonego sznura przyłączeniowego. W przypadku, gdy kabel zasilający cyrkulatora pełni funkcję urządzenia odłączającego, należy zadbać, aby przez cały czas był on łatwo dostępny.

Upewnić się, że żadne z kabli elektrycznych nie stykają się ze złączami lub rurami kanalizacyjnymi.

Nigdy nie stosować napięcia międzyprzewodowego na żadnym ze złączy komunikacyjnych wanny.

Upewnić się czy wybrane przez użytkownika przewody rurowe spełniają wymogi dotyczące maksymalnych wartości temperatur i ciśnienia.

Przed uruchomieniem sprawdzić czy wykonane zostały wszystkie połączenia elektryczne i, o ile ma zastosowanie, połączenia komunikacyjne.

Wykorzystywane czynniki chłodnicze są cięższe od powietrza, dlatego w przypadku nieszczelności zastąpią je, co doprowadzi do utraty przytomności. Kontakt z wyciekającym czynnikiem chłodniczym doprowadzi do poparzeń skóry. Aby uzyskać więcej informacji, patrz tabliczka znamionowa cyrkulatora, na której oznaczono typ wykorzystywanego czynnika chłodniczego, najnowsza karta charakterystyki substancji niebezpiecznej US (SDS) producenta wcześniej znana jako MSDS, a także karta charakterystyki substancji niebezpiecznej EU.

Upewnić się, że wszystkie otwory spustowe zbiornika zostały zamknięte oraz, że wszystkie połączenia kanalizacyjne zostały odpowiednio zabezpieczone. Ponadto przed napełnieniem należy sprawdzić czy dokładnie usunięto wszelkie pozostałości.

Aby uniknąć rozlania, przed napełnieniem pojemniki należy umieścić w wannie.

Płyn na bazie oleju zwiększają swoją objętość pod wpływem ciepła. Unikać przepelnienia zbiornika.

Korzystać wyłącznie z zatwierdzonych płynów wymienionych w instrukcji obsługi. Wykorzystywanie innych płynów skutkować będzie utratą gwarancji. Nigdy nie używać 100% glikolu.

W przypadku wody, której temperatura przekracza 80°C należy uważnie obserwować poziom płynu, ponieważ konieczne będzie częste dopełnianie. Ponadto powoduje tworzenie się pary.

Mieszany wodą/glikolu wymagają częstego uzupełniania czystą wodą. W przeciwnym razie wartość procentowa glikolu wzrośnie, co będzie skutkowało dużą lepkością oraz słabą wydajnością.

W przypadku stosowania zatwierzonego płynu innego niż woda lub w przypadku wykonywania prac konserwacyjnych, gąźle prawdopodobny jest kontakt z płynem, patrz środki ostrożności opisane w SDS oraz karta charakterystyki substancji niebezpiecznej EC.

Upewnić się, że płyn nie będzie generował gazów toksycznych. Podczas pracy, nad płynem mogą zgromadzić się gazy palne.

W przypadku wykorzystywania glikolu etylenowego i wody należy regularnie sprawdzać stężenie płynu oraz pH. Zmiany stężenia i pH mogą wpłynąć na wydajność układu.

Upewnić się, że punkt odcojęcia w przypadku zbyt wysokiej temperatury ma wartość niższą od punktu palenia dla wybranego płynu przewodzącego ciepło.

Najwyższa temperatura robocza określona w EN 61010 (IEC 1010) musi zostać ograniczona do 25°C poniżej punktu palenia płynu wanny.

Przed przystąpieniem do pracy z płynem lub przed spuszczeniem upewnić się, że jego temperatura nie stwarza niebezpieczeństwa (ma wartość 40°C).

Nigdy nie obsługiwać uszkodzonego, nieszczelnego sprzętu oraz, jeśli jego kable zostały uszkodzone.

Nigdy nie dopuszczaj do sytuacji, w której wanna będzie pracować bez płynu w zbiorniku.

Nigdy nie obsługiwać wanny ani nie dodawać płynu do zbiornika, jeśli wcześniej zdjęto panele.

Do czyszczenia wanny nie należy używać rozpuszczalników. Zamiast tego wystarczy miękka szmatka i woda.

Przed przetransportowaniem i/lub zmagazynowaniem zbiornika w temperaturach oscylujących wokół granicy zamarzania, zbiornik należy opróżnić.

Przed przetransportowaniem lub przystąpieniem do jakichkolwiek prac serwisowych czy konserwacyjnych zawsze należy pamiętać o wyłączeniu wanny oraz odłączeniu zasilania elektrycznego. Prace serwisowe oraz naprawy należy zlecić wykwalifikowanemu technikowi.

Podczas transportowania wanny niezbędne jest zachowanie należytej ostrożności. Nagle wstrząsy lub upadek mogą skutkować uszkodzeniem podzespołów.

W przypadku rozlania materiałów niebezpiecznych odpowiedzialność za ich neutralizację spoczywa na użytkowniku. Aby zapoznać się z informacjami dotyczącymi odkażania oraz środków czyszczących, skontaktować się z producentem.

Jeśli wanna ma zostać przetransportowana i/lub zmagazynowana w niskich temperaturach niezbędne jest spuszczenie z niej płynów, a następnie przeplukanie mieszaniną wodą/glikol o czystości laboratoryjnej w proporcjach 50/50.

Wycofanie z eksploatacji może zostać przeprowadzone wyłącznie przez wykwalifikowanego sprzedawcę wykorzystującego sprzęt posiadający niezbędne atesty. Niezbędne jest przestrzeganie wszystkich obowiązujących przepisów.

Wykonywanie czynności montażowych, konserwacyjnych lub obsługi odbiegająca od wytycznych opisanych w instrukcji obsługi może skutkować niebezpiecznymi sytuacjami oraz utratą gwarancji producenta.

W przypadku wanien Sahara oraz wolnostojących cyrkulatorów zanurzeniowych niezbędne jest użycie dostarczonych nakrętek oraz podkładek w celu zamocowania taśmy uziemiającej do górnej części zbiornika metalowego.

Nigdy nie dopuszczać do sytuacji, w której wanna będzie pracować bez cyrkulatora.

Nie montować cyrkulatora zanurzeniowego odwrótnie, ponieważ sznur przyłączeniowy może zetknąć się z płynem zbiornika.

W przypadku wanien, w których wykorzystano przezroczysty akryl oraz polilinen fenylu (PPO) należy stosować wyłącznie wodę.

Skonfigurować oprogramowanie wanny w celu zachowania zgodności z płynem.

## Instalacja cyrkulatorów wanien Arctic, Glacier i Sahara:

Upewnić się, że żadne z kabli elektrycznych nie stykają się ze złączami lub rurami kanalizacyjnymi.

W przypadku wanien chłodniczych, pomiędzy cyrkulatorem zanurzenia a złączami RJ45 (podobne do Ethernet) należy zamontować dostarczony kabel ekranowany RJ45. Jest to wymagane do prawidłowej pracy.

W przypadku wanien chłodniczych kabel zasilający zamontować ze złącza w tylnej części sterownika. A do złącza w tylnej części wanny chłodniczej. B podłączyć do kabla zasilającego wanny. C do uziemionego gniazdka zasilającego.

W przypadku wanien chłodniczych nigdy nie należy podłączać wejścia zasilania sterownika A do gniazda zasilania. Nigdy nie podłączać gniazda zasilania B do żadnego innego urządzenia poza cyrkulatorem zanurzenia.

W przypadku wanien niechłodniczych kabel zasilania C wanny należy podłączyć do uziemionego gniazda zasilania.

Złącza kanalizacyjne zewnętrzne układu cyrkulacyjnego znajdują się w tylnej części cyrkulatora zanurzenia. → jest przepływem powrotnym z obwodu zewnętrznego. ● jest przepływem wylotowym do obwodu zewnętrznego (strona zasilająca). Złącza: 16 mm O.D. Zdjąć nakrętkę łączącą oraz płytki w celu zamontowania dostarczonych wraz z cyrkulatorem końcówek węży i zacisków 8 mm lub 12 mm.

Aby zapobiec uszkodzeniu instalacji wodociągowej cyrkulatora podczas zdejmowania/montowania złączy należy używać 19 mm klucza nakładkowego.

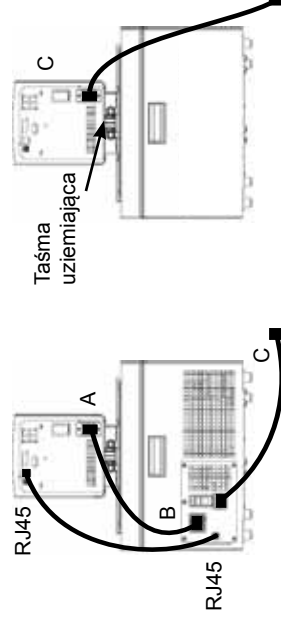



## Instrucțiuni Esențiale de Siguranță Căzi de laborator

Consultați manualul sau contactați-ne înainte de a merge mai departe dacă oricare dintre aceste instrucțiuni sunt pe deplin înțelese.

**Siguranță, toate produsele:**

**⚠ DANGER** indică o situație periculoasă iminentă care, în cazul în care nu se evită, poate cauza moarte sau vătămare corporală gravă.

**⚠ WARNING** indică o situație potențial periculoasă care dacă nu se evită poate cauza moartea sau rănirea gravă.

**⚠ CAUTION** indică o situație potențial periculoasă care dacă nu se evită poate cauza răni minore sau moderate. Se folosește și pentru a atenționa împotriva practicilor periculoase.

 menit să atenționeze utilizatorul cu privire la prezența „voltaajului periculos” neizolat din incinta propagatorului. Magnitudinea voltaajului este destul de mare pentru a prezenta risc de șoc electric.

 indică prezența suprafețelor încinse.

 indică citirea manualului.

 Această etichetă indică utilizarea unui agent frigorific inflamabil sys romanian.

Nu folosiți cada ca dispozitiv steril sau conectat la pacient. În plus, cada nu este concepută pentru a se folosi în Locuri Periculoase din Clasele I, II sau III conform definițiilor Codului Electric Național.

Nu plasați cada niciodată în locuri sau medii unde se află niveluri crescute de căldură, umezeală sau substanțe corozive. Consultați manualul de utilizare pentru parametrii operaționali.

Cazile frigorifice se lasă în poziție verticală la temperatura camerei (~25°C) pentru 24 de ore înainte de a se pomii. Acest lucru asigură scurgerea înapoi în compresor a uleiului de lubrifiere.

Conectați cada o priză împământată corespunzător.

Învelișul protector al circuitului se află pe latura din spate a căzii și nu este conceput spre a se folosi pentru deconectare.

Operați propagatorul folosind numai cablul furnizat. Cablul de alimentare al propagatorului trebuie să fie în permanență ușor accesibil dacă se folosește ca dispozitiv de deconectare.

Cablurile electrice nu trebuie să intre în contact cu țevile sau conexiunile de instalație.

Niciodată să nu aplicați tensiune de linie la conexiunile de comunicare ale căzii.

Asigurați-vă că țevile selectate îndeplinesc cerințele privind temperatura și presiunea maximă.

Asigurați-vă că toate conexiunile electrice și de comunicare (dacă este cazul) se fac înainte de pornire.

Agentei frigorifici folosiți sunt mai grei decât aerul, iar dacă există o scurgere ei vor înlocui oxigenul și vor cauza pierderi de conștiență. Contactul cu scurgerile de agent frigorific poate cauza ardere la nivelul pielii.

Consultați plăcuța de identificare a propagatorului pentru tipul de agent frigorific folosit și apoi cea mai actuală Fișă cu Date de Siguranță SUA(FDS) a producătorului cunoscută drept MSDS și Fișa cu Date de

Siguranță UE pentru informații suplimentare.

Asigurați-vă ca orificiile pentru scurgerea rezervorului sunt închise și toate conexiunile instalației sunt în siguranță. De asemenea, asigurați-vă că înainte de umplere s-au înlăturat toate reziduurile.

Puneți recipientele în cadă înainte de umplere pentru a evita împrăștierea.

Lichidele pe bază de ulei se dilată la căldură. Evitați umplerea în exces a rezervorului.

Folosiți numai lichidele aprobate care sunt enumerate în manual. Folosirea altor lichide anulează garanția. Niciodată nu se folosește 100% glicol.

Când folosiți apă la peste 80°C trebuie să monitorizați cu atenție nivelul de lichid, sunt necesare reumpleri frecvente. De asemenea, se produc aburi.

Amestecurile de apă/glicol necesită umplere cu apă pură astfel se va mări procentajul de glicol, iar acest lucru va rezulta în nivel crescut al văscozității și randament scăzut.

În afară de apă, înainte de folosirea vreunui lichid aprobat sau când se efectuează întreținerea când este probabilă intrarea în contact cu fluidul trebuie să consultați FDS și Fișa cu Date de Siguranță CE pentru măsurile de siguranță privind manevrarea.

Asigurați-vă că fluidul nu produce gaze toxice. Pe parcursul folosirii lichidului se pot acumula gaze inflamabile.

Verificați regulat concentrația lichidului și pH-ul când folosiți etilen glicol. Schimbările concentrației și a pH-ului poate afecta performanța instalației.

Asigurați-vă că punctul de întrerupere a depășirii temperaturii este setat mai jos decât punctul de ardere pentru transferul de căldură al fluidului selectat.

Cea mai ridicată temperatură de funcționare conform EN 61010 (IEC 1010) trebuie să se limiteze la 25°C sub punctul de ardere al lichidului din cadă.

Asigurați-vă că fluidul se află la o temperatură sigură (sub 40°C) înainte de a-l manevra sau scurge.

Niciodată să nu operați echipament care prezintă avarii sau scurgeri sau cabluri avariate.

Cada nu se operează niciodată fără fluid în rezervor.

Cada nu se operează niciodată și nu se adaugă fluid în rezervor dacă panourile sunt îndepărtate.

Nu curățați cada folosind solvenți, folosiți un material moale și apă.

Rezervorul se scurge înainte de a se transporta și/sau depozita la temperaturi aproape sau sub cele de îngheț.

Cada se oprește mereu și se deconectează de la tensiunea de alimentare de la sursa de energie înainte de a se muta sau înainte de efectuare oricăror proceduri de reparație sau întreținere. Reparațiile și întreținerea se efectuează de către tehnicienii calificați.

Cada se transportă cu grijă. Zguduiele sau căderile pot avaria componentele căzii.

Utilizatorul este responsabil de decontaminare dacă se varsă materiale periculoase. Consultați producătorul cu privire la compatibilitatea agenților de decontaminare și de curățare.

Cada trebuie să se scurgă și se clătească cu un amestec de laborator din 50/50 glicol/apă dacă se va transporta și/sau depozita la temperaturi scăzute.

Retragerea din funcționare se efectuează numai de către un furnizor calificat folosind echipament certificat.

Trebuie să se respecte toate prevederile curente.

Performanța instalației, operarea sau procedurile de întreținere pe lângă cele descrise în manual pot să cauzeze situații periculoase sau se anuleze garanția producătorului.

Pentru căzile Sahara și pentru propagatoarele de cufundare de sine stătătoare se folosește piulița și șaiba furnizate pentru a fixa banda de legare pe partea de sus a rezervorului de metal.

Cada nu se operează niciodată dacă propagatorul de cufundare este înăturat.

Nu montați invers propagatorul de cufundare; cablul de alimentare ar putea intra în contact cu lichidul din rezervor.

Acril transparent și oxid de polifenilen. Căzile se folosesc numai cu apă.

Ajustați softul căzii pentru a se potrivi cu lichidul folosit.

## Instalare Propagatoare Arctic, Glacier și Sahara pentru căzi:

Cablurile electrice nu trebuie să intre în contact cu țevile sau conexiunile de instalație.

Pentru căzile frigorifice se instalează cablul protejat RJ45 furnizat între propagatorul de cufundare și conectorii RJ45 pentru cadă (asemenea Ethernet). Necesare pentru operarea corespunzătoare.

Pentru căzile frigorifice se instalează cablul de alimentare de la conectorul de pe latura din spate a controlerului A la conectorul de pe partea laterală a căzii frigorifice B. Cablul de alimentare C al căzii se conectează la priza de alimentare pământată.

Pentru căzile frigorifice boma de intrare pentru controlerul A nu se conectează niciodată la o priză de alimentare. Priza de alimentare B nu se conectează niciodată la propagatorul de cufundare.

Pentru băile nefrigorifice se conectează cablul de alimentare C al căzii la o priză de alimentare împământată.

Conexiunile instalației pentru circulație externă se află pe partea laterală a propagatorului de cufundare.

→ ● este fluxul de întoarcere de la aplicația externă. ● → este fluxul de evacuare pentru aplicația externă (oferită). Conexiunile au 16 mm O.D. Îndepărtați piulițele și plăcile de cuplare pentru a instala cârligele și clemele de 8 și 12 mm livrate alături de propagator.

Pentru a preveni daunele la instalația propagatorului se folosește o contracteie de 19 mm când îndepărtați/instalați conexiunile.

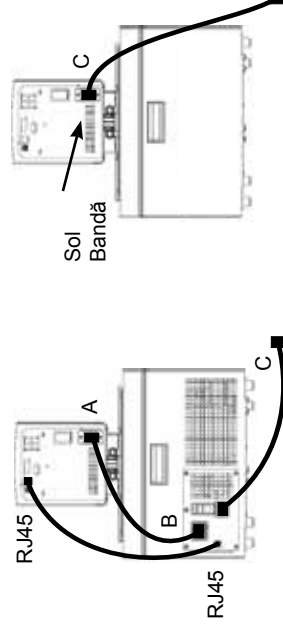

**SK**

## Základné bezpečnostné pokyny Laboratórne kúpele

Ak nerozumiete niektorému z týchto pokynov, pred pokračovaním si prečítajte príručku alebo nás kontaktujte.

### Bezpečnosť, všetky produkty:

 označuje bezprostredne nebezpečnú situáciu, ktorá, ak sa jej nevyhnete, spôsobí usmrtenie alebo vážne poranenie.

 označuje potenciálne nebezpečnú situáciu, ktorá, ak sa jej nevyhnete, môže spôsobiť usmrtenie alebo vážne poranenie.

 označuje potenciálne nebezpečnú situáciu, ktorá, ak sa jej nevyhnete, môže spôsobiť ľahké alebo stredne ťažké poranenie. Používa sa aj ako varovanie pred nebezpečnými postupmi.

 Služí na upozornenie používateľa na prítomnosť neizolovaného „nebezpečného napätia“ pod krytom obehového čerpadla. Napätie je dostatočne vysoké na to, aby predstavovalo riziko úrazu elektrickým prúdom.

 označuje prítomnosť horúcich povrchov.

 označuje nutnosť prečítania príručky.

 Táto etiketa uvádza, že sa používa horľavé chladivo sys slovak.

Kúpeľ nepoužívajte ako sterilné zariadenie alebo ako zariadenie pripojené k pacientovi. Kúpeľ okrem toho nie je určený na použitie v nebezpečných prostrediach triedy I, II alebo III definovaných kódom NEC (National Electrical Code).

Kúpeľ nikdy neumiestňujte na miesto alebo v prostredí, kde je prítomné nadmerné teplo, vlhkosť alebo korózne materiály. Prevádzkové parametre nájdete v návode na použitie.

24 hodín pred spustením nechajte chladené kúpele vo zvislej polohe pri izbovej teplote (~25 °C). Tým sa zaisťí, že mazací olej sa preleje späť do kompresora.

Kúpeľ pripojte k správne uzemnenej zásuvke.

Chránič obvodu sa nachádza na zadnej strane kúpela a nie je určený na prostriedok na odpaňovanie.

Obehové čerpadlo prevádzkujte iba pomocou dodaného kábla. Ak sa napájací kábel obehového čerpadla používa ako zariadenie na odpojenie od elektriny, musí byť po celý čas ľahko prístupný.

Uistite sa, že elektrické káble nie sú v kontakte so žiadanou z vodovodných prípojok a potrubí.

Nikdy nepripájajte sieťové napätie na žiadne z komunikačných pripojení kúpela.

Uistite sa, že vybrané potrubie spĺňa požiadavky na maximálnu teplotu a tlak.

Pred začatím sa uistite, že sú vykonané všetky elektrické a prípadne aj komunikačné pripojenia.

Použitie chladivá sú ťažšie ako vzduch a ak dôjde k úniku, nahradia kyslík a spôsobia stratu vedomia.

Kontakt s unikajúcim chladivom môže spôsobiť popálenie pokožky. Typ použitého chladiva nájdete na typovom štítku obehového čerpadla a ďalšie informácie nájdete v poslednej karte bezpečnostných údajov (KBÚ) pre USA, predtým známej ako MSDS a karte bezpečnostných údajov pre EÚ.

Uistite sa, že sú všetky odtokové otvory zatvorené a že sú všetky potrebné spoje pevné. Zaisťte tiež, aby boli pred plnením všetky zvyšky dôkladne odstránené.

Aby nedošlo k rozliatiu, pred naplnením umiestnite do kúpela nádoby.

Kvapaliny na báze oleja sa pri zohriatí rozťahujú. Zabráňte prepĺneniu nádrže.

Používajte iba schválené kvapaliny uvedené v návode na použitie. Použitie iných kvapalín zruší platnosť záruky. Nikdy nepoužívajte 100 % glykol.

Pri použití vody s teplotou nad 80 °C starostlivo sledujte hladinu kvapaliny, bude potrebné časté dolievanie. Bude sa tiež vytvárať para.

Zmesi vody/glykolu vyžadujú dolievanie čistej vody, v opačnom prípade sa zvýši percentuálny podiel glykolu, čo má za následok vysokú viskozitu a znížený výkon.

Pred použitím akejkolvek inej schválenej kvapaliny ako vody alebo pri vykonávaní údržby, keď je pravdepodobný kontakt s kvapalinou, si prečítajte KBÚ výrobcu a kartu bezpečnostných údajov ES, v ktorej sú uvedené opatrenia pri manipulácii.

Uistite sa, že kvapalina nemôže generovať žiadne toxické plyny. Počas používania sa v kvapaline môžu vytvárať horľavé plyny.

Pri použití etylénglykolu a vody v pravidelných intervaloch kontrolujte koncentráciu kvapaliny a pH. Zmeny koncentrácie a pH môžu ovplyvniť výkon systému.

Uistite sa, že medzný bod nadmernej teploty je nastavený nižšie, ako je bod vzplanutia vybranej teplotosnej kvapaliny.

Najvyššia prevádzková teplota definovaná normou EN 61010 (IEC 1010) musí byť obmedzená na 25 °C pod bodom vzplanutia tekutiny v kúpeľi.

Pred manipuláciou alebo vypúšťaním sa uistite, že kvapalina má bezpečnú teplotu (do 40 °C).

Nikdy neprevádzkujte poškodené alebo netesné zariadenie alebo v prípade akéhokoľvek poškodenia káblov.

Nikdy nepoužívajte kúpeľ, ak v nádržke nie je kvapalina.

Keď sú odstránené panely, nepoužívajte kúpeľ ani nedolievajte kvapalinu do nádržky.

Kúpeľ nečistite pomocou rozpušťadiel, používajte jemnú handričku a vodu.

Pred prepravou a/alebo skladovaním blízko alebo pod bodom mrazu vypustíte nádrž.

Pred presúvaním alebo vykonaním akýchkoľvek servisných postupov alebo údržby vždy vypnite kúpeľ a odpojte napájacie napätie od zdroja elektrickej energie. Servis a opravy prenechajte kvalifikovanému technikovi.

Kúpeľ pripravujte opatrne. Náhle otrasy alebo pády môžu poškodiť jeho komponenty.

V prípade rozliatia nebezpečných materiálov je používateľ zodpovedný za dekontamináciu. Informácie o dekontaminácii alebo kompatibilných čistiacich prostriedkoch vám poskytne výrobca.

Ak má byť kúpeľ prepravovaný alebo skladovaný pri nízkych teplotách, musí byť najskôr vypustený a potom prepláchnutý zmesou vody/glykolu laboratórneho stupňa v pomere 50/50.

Vyradenie z prevádzky môže vykonať len oprávnený predajca pomocou certifikovaného vybavenia. Je nutné dodržiavať všetky platné zákonné ustanovenia.

Vykonanie inštalácie, prevádzky alebo postupov údržby, ktoré nie sú popísané v tomto návode, môže viesť k nebezpečným situáciám a bude viesť k zrušeniu platnosti záruky výrobcu.

V prípade kúpeľov Sahara a samostatne stojacich ponorných obehových čerpadiel použite dodanú maticu a podložku naripevnenie uzemňovacieho popruhu k hornej časti kovovej nádrže.

Nikdy nepoužívajte kúpeľ s odstráneným ponorným obehovým čerpadlom.

Ponorné obehové čerpadlo nemontujte dozadu; sieťový kábel by sa mohol dotknúť nádržky na kvapalinu.

Transparentné akrylové a polyfenylén oxidové (PPO) kúpele sú používané len s vodou.

Nastavte softvér kúpeľa tak, aby sa zhodoval s použitou kvapalinou.

## Inštalácia obehových čerpadiel pre kúpele Arctic, Glacier a Sahara:

Uistite sa, že elektrické káble neprídu do styku so žiadnou z vodovodných prípojok a potrubí.

V prípade chladiacich kúpeľov vložte dodaný štenený kábel RJ45 do konektorov RJ45 (podobné ako ethernetové konektory) na ponornom obehovom čerpadle a na kúpeľi. Tento krok je nevyhnutný pre správne fungovanie.

V prípade chladiacich kúpeľov vložte napájací kábel do konektora na zadnej strane riadiacej jednotky A a do konektora na zadnej strane chladiaceho kúpeľa B. Napájací kábel kúpeľa C pripojte do uzemnenej zásuvky.

V prípade chladiacich kúpeľov nikdy nepripájajte napájací vstup riadiacej jednotky A k elektrickej zásuvke. Nikdy nepripájajte elektrickú zásuvku B k ničomu inému ako k ponornému obehovému čerpadlu.

V prípade nechladiacich kúpeľov pripojte napájací kábel kúpeľa C k uzemnenej zásuvke.

Potrubné prípojky pre externý obeh sú umiestnené na zadnej strane ponorného obehového čerpadla.

→ je spätný tok z externej aplikácie. ● → je výstupný tok do externej aplikácie (na strane prívodu). Prípojky majú vonkajší priemer 16 mm. Odstráňte prevlečné matice a platne na inštaláciu dodaných 8 mm alebo 12 mm hrotov hadíc dodaných s obehovým čerpadlom.

Pri demontáži/montáži pripojení použite 19 mm podporný kľúč, aby nedošlo k poškodeniu potrubia obehového čerpadla.

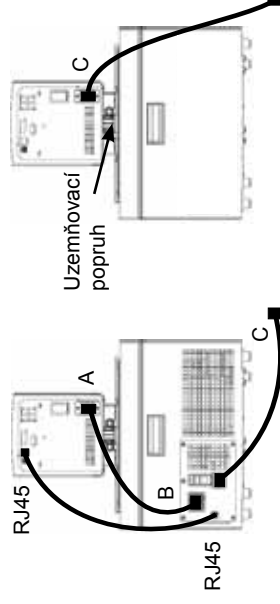

## Osnovna varnostna navodila Laboratorijske kopeli

Če ne razumete kategorikoli navodila, si poglejte navodila za uporabo ali stopite v stik z nami, še preden nadaljujete.

### Varnost - vsi izdelki:

 Opozarja na akutne nevarne okoliščine, ki lahko – če se jim ne izognete – povzročijo resne ali celo smrtne nevarne poškodbe.

 Opozarja na morebitno nevarne okoliščine, ki lahko – če se jim ne izognete – povzročijo resne ali celo smrtne nevarne poškodbe.

 Opozarja na akutne nevarne okoliščine, ki lahko – če se jim ne izognete – povzročijo lažje ali srednje nevarne poškodbe. Uporablja se tudi kot opozorilo proti nevarni praksi.

 opozarja na bližino neizolirane nevarne napetosti v ohišju cirkulatorja. Napetost je dovolj visoka, da lahko povzroči električni šok.

 opozarja na vroče površine.

 opozarja, da je potrebno prebrati navodila.

 Ta oznaka označuje, da se uporablja vnetljivo hladilno sredstvo.

Ne uporabljajte kopeli kot sterilne naprave, ali na prave, povezane z bolnikom. Poleg tega kopel ni načrtovana za uporabo v napravah, ki delujejo v nevarnih okoljih I., II. in III. razreda po določilih Nacionalnega pravilnika za električne naprave.

Nikoli ne namestite kopeli na mesto ali v okoljske pogoje z visoko temperaturo, vlago ali jedkimi snovmi. Delovni parametri so navedeni v navodilih za uporabo.

Hladilne kopeli morajo v pokončnem položaju pri sobni temperaturi (~25 °C) mirovati 24 ur pred začetkom obratovanja. Slednje zagotavlja, da olje za mazanje odteče nazaj v kompresor.

Priključite kopol v pravilno ozemljeno vtičnico.

Zaščita krogotoka, ki je nameščena na zadnjem delu kopeli ni načrtovana kot izklopna naprava.

Naprava lahko deluje le s priloženim napajalnim kablom. Če se napajalni kabel cirkulatorja uporabi tudi za odklop, mora biti vedno lahko dosegljiv.

Zagotovite, da se električni kablji ne dotikajo vodovodnih priključkov ali cevi.

Nikoli ne priključite omrežne napetosti neposredno na katerikoli priključek kopeli.

Poskrbite, da bodo izbrane cevi izpolnjevale zahteve glede temperature in tlaka.

Poskrbite, da bodo pred zagonom vzpostavljene vse električne in, če obstajajo tudi komunikacijske povezave.

Uporabljeni hladilna sredstva so težja od zraka. Če obstajajo netesna mesta, bodo izpodrinila kisik in povzročila izgubo zavesti. Stik z uhajajočim hladilnim sredstvom bo povzročil ozeblino. Dodatne informacije boste našli na cirkulatorjevi ploščici s podatki, na kateri je naveden tip hladilnega sredstva, najnovjšem varnostnem listu za ZDA (SDS), ki je bil prej poznan pod nazivom MSDS in varnostnem listu za EU.

Zagotovite, da bodo zaprta vsa praznilna mesta rezervoarja in da so zavarovani vsi cevni priključki. Prav tako poskrbite, da bodo pred polnjenjem temeljito odstranjene vse usedline.

Da preprečite polivanje, postavite vaše vsebnike v kopol še pred polnjenjem.

Tekočine na osnovi olja se pri segrevanju razširijo. Preprečite, da bi bil rezervoar preveč napolnjen.

Uporabite le odobrene tekočine, navedene v predmetnih navodilih za uporabo. Uporaba drugih tekočin izniči veljavnost garancije. Nikoli ne uporabite 100-odstotnega glikola.

Če uporabljate vodo, segreto na več kot 80 °C pazljivo spremljajte nivo tekočine, saj bo potrebno pogosto dolivanje. Poleg tega nastaja para.

Pri mešanica vode in glikola je potrebno dolivati čisto vodo, saj se v nasprotnem primeru delež glikola poveča, slednje pa povzroči visoko viskoznost in slabo zmogljivost.

Z izjemo vode, morate pred uporabo katerekoli odobrene tekočine ali pred izvajanjem vzdrževalnih del, pri katerih je zelo verjeten stik s tekočino, preveriti proizvajalčev SDS in varnostne liste EU z napotki za ravnanje.

Poskrbite, da tekočina ne tvori strupenih plinov. Med uporabo se lahko nad tekočino nakopičijo vnetljivi plini.

Ko uporabljate etilen glikol in vodo redno preverjajte koncentracijo tekočine in pH. Spreminjanje koncentracije in vrednosti pH lahko vpliva na zmogljivost sistema.

Poskrbite, da je izklopna vrednost za temperaturo nastavljena nižje od plamenišča tekočine, ki se uporablja kot prenosni medij.

Najvišja delovna temperatura, kot je določena v EN 61010 (IEC 1010), mora biti omejena na 25 °C pod plameniščem tekočine v kadi.

Zagotovite, da ima tekočina varno temperaturo (pod 40 °C) pred rokovanjem ali izpustom.

Nikoli ne upravljajte poškodovane ali netesne opreme, ali opreme s poškodovanimi kablji.

Nikoli ne uporabljajte kopeli, če v rezervoarju ni tekočine.

Nikoli ne uporabljajte kopeli ali dodajajte tekočine v rezervoar, če so odstranjeni paneli.

Ne čistite kopeli s topli, uporabite mehko krpo in vodo.

Pred transportom izpraznite rezervoar n/ali shranite pri temperaturi zmrzovanja ali v njeni bližini.

Vedno izklopite kopol in odklopite napajalno napetost preden premikate napravo ali izvajate popravila ali vzdrževalne posege. Servis in popravila lahko izvaja le ustrezno usposobljen tehnik

Predvidno transportirajte kad. Nenadni sunki ali padci lahko poškodujejo njene dele.

Uporabnik je zadolžen za dekontaminacijo, če se polijejo nevarne snovi. Posvetujte se s proizvajalcem glede dekontaminacije in/ali primernih čistil.

Če morate kad transportirati n/ali shraniti pri nizkih temperaturah, jo morate izprazniti in nato izplakniti z mešanico 50/50 glikol/voda laboratorijske kakovosti.

Razgradijo naprave lahko opravi le ustrezno usposobljen zastopnik, ki uporablja odobreno opremo.

Uporabljajte vse veljavne zadevne predpise.

Izvajanje kakršnihkoli postopkov, povezanih z montažo, delovanjem ali vzdrževanjem, ki niso navedeni v teh navodilih, lahko povzroči nevarne okoliščine in izniči veljavnost garancije proizvajalca.

Pri kopolih Sahara in samostojnih potopnih cirkulatorjih uporabite priloženo matico in podložko za pritrditev ozemljitvenega traka na zgornjo stran kovinskega rezervoarja.

Kopol ne sme nikoli obratovati, če je odstranjen potopni cirkulator.

Nikoli ne montirajte cirkulatorja v obrnjenem položaju, saj bi lahko prišel napajalni kabel v stik s tekočino v rezervoarju.

Kopeli iz prozornega akrila in polipropilenskega oksida (PPO) se lahko uporabljajo samo z vodo.

Prilagodite programsko opremo kopeli, da ustreza uporabljeni tekočini.

## Namestitev cirkulatorjev za kopeli Arctic, Glacier in Sahara:

Zagotovite, da se električni kabli ne dotikajo vodovodnih priključkov ali cevi.

Pri hlajenih kopolih namestite priloženi oplaščeni kabel RJ45 med potopni cirkulator in priključke RJ45 na kopeli (podobno kot pri Ethernetu). To je nujno za pravilno delovanje.

Pri hlajenih kopolih namestite napajalni kabel od priključka na zadnji strani regulatorja A do priključka B na zadnji strani hlajene kopeli.

Pri hlajenih kopolih nikoli ne povežite napajalnega dovoda A z omrežno vtičnico. Nikoli ne povežite napajalnega priključka B z ničemer drugim, kot s potopnim cirkulatorjem.

Pri nehlajenih kopolih priključite napajalni kabel kopeli C z ozemljeno omrežno vtičnico.

Priključki za zunanji obtok so na zadnji strani potopnega cirkulatorja. ➔ povratni vod zunanje aplikacije ● ➔ dovod zunanje aplikacije (dovodna stran). Priključki imajo zunanji premer 16 mm.

Odstranite prekrivno matico in plošče ter namestite cevni nastavek 8 mm ali 12 mm ter sponke, dobavljene skupaj s cirkulatorjem.

Zaradi preprečevanja poškodb na krogotoku cirkulatorja, uporabite pri namestitvi/odstranjevanju priključkov dodatni držalni ključ 19 mm.

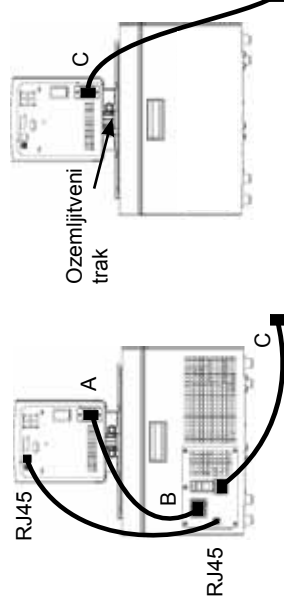





## Osnovna bezbednosna uputstva Laboratorijska korita

Ako ne razumete bilo koja od ovih uputstava, pogledajte priručnik ili nas kontaktirajte pre nego što nastavite.

### Bezbednost, svi proizvođači:

 označava neposrednu opasnost koja, ako se ne izbegne, će da dovede do smrti ili teške povrede.

 označava potencijalno opasnu situaciju koja, ako se ne izbegne, može da dovede do smrti ili teške povrede.

 označava potencijalno opasnu situaciju koja, ako se ne izbegne, može da dovede do lakše ili srednje teške povrede. Takođe može da se koristi da upozori na nesigurne radnje.

 upozorava korisnika na prisustvo neizolovanog „opasnog napona“ unutar kućišta cirkulatora. Napon je dovoljno velik da predstavlja opasnost od strujnog udara.

 ukazuje na prisustvo vrelih površina.

 ukazuje da je potrebno pročitati priručnik.

 Ova naljepnica označava da se koristi zapaljivo rashladno sredstvo.

Nemojte da koristite korito kao sterilni uređaj ili uređaj povezan na pacijenta. Pored toga, korito nije predviđeno za upotrebu na opasnim lokacijama klase I, II ili III prema definicijama Nacionalnog električnog standarda (engl. National Electrical Code).

Nikad nemojte da postavljate korito tamo gde je prisutna prekomerna toplota, vlažnost ili nagrizajući materijali. Redni parametri navedeni su u korisničkom priručniku.

Pre pokretanja ostavite hladna korita u uspravnom položaju 24 sata na sobnoj temperaturi (~25 °C). Na ovaj se način osigurava da ulje za podmazivanje istekne nazad u kompresor.

Povežite korito na pravilno uzemljenu utičnicu.

Osigurač koji se nalazi sa zadnje strane korita nije predviđen da se koristi kao uređaj za iskopčavanje.

Koristite cirkulator samo s priloženim kablom. Ako se kabl za napajanje cirkulatora koristi kao uređaj za iskopčavanje, uvek mora da bude lako dostupan.

Pazite da električni kablovi ne dođu u dodir s vodovodnim priključcima ili cijevima.

Nikad nemojte da primenjujete linijski napon na komunikacijske priključke korita.

Pazite da izabrane cevi ispunjavaju zahteve za maksimalnu temperaturu i pritisak.

Pazite da postavite sve električne i, ako postoje, komunikacijske priključke pre pokretanja.

Korišćena sredstva za hlađenje su teža od vazduha a i, ako dođe do curenja, zamenite kiseonik te dovesti do gubitka svesti. Kontakt sa sredstvom za hlađenje koje curi uzrokuje opekotine. Pogledajte pločicu s podacima cirkulatora za vrstu korišćenog sredstva za hlađenje, a zatim potražite dodatne informacije u najnovijem bezbednosnom listu za SAD (engl. Safety Data Sheet; SDS), ranije poznatom kao MSDS, kao i bezbednosnom listu za EU.

Proverite da li su svi odvodni otvori rezervoara zatvoreni i svi vodovodni priključci pričvršćeni. Takođe temeljito uklonite sve ostatke pre punjenja.

Da ne bi došlo do prosipanja, postavite kontejnere u korito pre punjenja.

Tečnosti na bazi ulja se šire prilikom zagrevanja. Nemojte da prepunjavate rezervoar.

Koristite samo odobrene tečnosti koje su navedene u priručniku. Korišćenje drugih tečnosti poništava garanciju. Nikad nemojte da koristite stoprocentni glikol.

Kada koristite vodu preko 80 °C pažljivo pratite nivo tečnosti, jer će biti potrebna česta dopunjavanja. Takođe se stvara para.

Mešavine voda/glikol zahtevaju dopunjavanje čiste vode, jer će se u suprotnom procenat glikola povećati i dovesti do visoke viskoznosti i slabih performansi.

Prije korišćenja bilo koje odobrene tečnosti, osim vode, ili prilikom obavljanja postupaka održavanja u kojima će verovatno doći do kontakta s tečnošću, pogledajte mere predostrožnosti prilikom rukovanja u bezbednosnom listu proizvođača i EZ bezbednosnom listu.

Pazite da tečnost ne može proizvesti nikakve otrovne gasove. Zapaljivi gasovi mogu da se nakupe nad tečnošću tokom korišćenja.

Prilikom upotrebe etilen glikola i vode redovno proveravajte koncentraciju tečnosti i pH vrednost. Promene u koncentraciji i pH vrijednosti mogu da utiču na performanse sistema.

Pazite da prekidna temperaturna tačka bude postavljena niže od temperature paljenja za odabranu tečnost za prenos toplote.

Najviša radna temperatura, prema definicijama standarda EN 61010 (IEC 1010), mora da bude ograničena na 25 °C ispod temperature paljenja tečnosti korita.

Pazite da tečnost bude na bezbednoj temperaturi (ispod 40 °C) pre rukovanja ili ispuštanja.

Nikad nemojte da koristite oštećenu opremu ili opremu koja propušta, kao ni opremu s oštećenim kablovima.

Nikad nemojte da koristite korito ako u rezervoaru nema tečnosti.

Nikad nemojte da koristite korito za dodavanje tečnosti u rezervoar sa skinutim pločama.

Nemojte da koristite rastvarače za čišćenje korita, već koristite meku krpu i vodu.

Ispraznite rezervoar pre prenosa i/ili čuvanja na temperaturama blizu ili ispod tačke smrzavanja.

Uvijek isključite korito i iskopčajte napon izvora napajanje iz izvora napajanje pre pomeranja ili obavljanja bilo kakvih postupaka servisiranja ili održavanja. Servisiranje i popravke treba da obavlja kvalifikovani servisier.

Oprezno prenosite korito. Naglo drmanje ili ispuštanje opreme može da ošteti njene komponente.

Korisnik je odgovoran za dekontaminaciju ako dođe do prosipanja opasnih materijala. Obratite se proizvođaču u vezi s kompatibilnošću sredstava za dekontaminaciju ili čišćenje.

Ako se korito prenosi i/ili čuva na niskim temperaturama, treba ga isprazniti, a zatim isprati mešavinom od 50/50 laboratorijskog glikola/vode.

Stavljanje izvan pogona mora da obavi isključivo kvalifikovani trgovac pomoću sertifikovane opreme. Mora da se pridržava svih važećih propisa.

Obavljanje postupaka ugradnje, korišćenja ili održavanja koji nisu opisani u priručniku može da dovede do opasne situacije i poništava garanciju proizvođača.

Kod korita Sahara i samostalnih potapajućih cirkulatora koristite priloženu maticu i podlošku da pričvrstite kaiš za uzemljavanje za vrh metalnog rezervoara.

Nikad nemojte da koristite korito ako je potapajući cirkulator skinut.

Nemojte obmuto postavljati potapajući cirkulator; kabl može da dođe u dodir s tečnošću iz rezervoara.

Providna akrilna korita i korita od polifenilena oksida se koriste samo s vodom.

Podesite softver korita tako da odgovara korišćenoj tečnosti.

## Ugradnja cirkulatora korita Arctic, Glacier i Sahara:

Pazite da električni kablovi ne dođu u dodir s vodovodnim priključcima ili cijevima.

Kod hladnih korita postavite priloženi zaštićeni kabl RJ45 između potapajućeg cirkulatora i priključaka za korito RJ45 (sličnih ethernetu). Ovo je obavezno za pravilan rad.

Kod hladnih korita postavite kabl za napajanje od priključka na zadnjoj strani kontrolera, A, do priključka na zadnjoj strani hladnog korita, B. Povežite kabl za napajanje, C, na uzemljenu utičnicu.

Kod hladnih korita nikad nemojte da povezujete napojni ulaz, A, na napojni izlaz, A, na napojni izlaz. Nikad nemojte da povezujete napojni izlaz, B, na bilo šta osim potapajućeg cirkulatora.

Kod nehladenih korita povežite kabl za napajanje korita, C, s uzemljenom utičnicom.

Vodovodni priključci za vanjsko cirkuliranje nalaze se sa zadnje strane potapajućeg cirkulatora. → ●

označava povratni protok od vanjskog uređaja. ● → označava izlazni protok prema vanjskom uređaju

(strana s koje se vrši snabdevanje). Priključci imaju spoljni prečnik od 16 mm. Skinite matice i ploče da

postavite priključke za crevo od 8 mm ili 12 mm i sppme koje se isporučuju uz cirkulator.

Da bi se sprečilo oštećenje vodovoda cirkulatora, mora se koristiti podešavajući klič od 19 mm za skidanje/ postavljanje vanjskih priključaka.

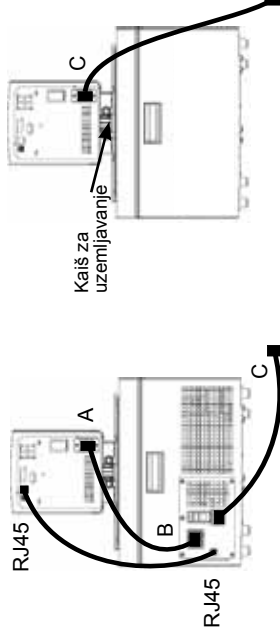

## Viktiga säkerhetsinstruktioner Laboratoriebad

Om någon av dessa anvisningar är svåra att förstå se handboken eller kontakta oss innan du går vidare.

### Säkerhet, alla produkter:

 anger en imminent riskfylld situation som, om den inte undviks, resulterar i allvarliga skador eller dödsfall.

 anger en riskfylld situation som, om den inte undviks, kan resultera i dödsfall eller allvarlig skada.

 anger en riskfylld situation som, om den inte undviks, kan resultera i lättare eller medelsvåra skador. Den ska även användas för att varna om riskfyllda metoder.

 avsedd för att varna användaren om ej isolerad "farlig spänning" inuti cirkulatorns hölje. Spänningen är tillräckligt hög för att utgöra en risk för elchock.

 anger att det finns heta ytor.

 anger att man bör läsa i handboken.

 Denna etikett anger att ett brandfarligt kylmedel används.

Använd inte badet som steril eller ansluten till patient. Badet är heller inte designad för användning i riskfyllda miljöer Klass I, II eller III, enligt definition i Nationella elbestämmelser.

Placera aldrig badet på en plats eller i en miljö med hög värme, luftfuktighet eller med frätande material. Se användarhandboken för driftsparametrar.

Lämna bad i en upprätt position vid rumstemperatur (~25°C) under 24 timmar innan den startas. Detta försäkrar att smörjoljan rinner tillbaka till kompressorn.

Anslut badet till ett korrekt jordat uttag.

Kretsbytare på baksidan av badet är inte avsett för att användas som avstängning.

Använd endast cirkulatorn med den medföljande nätsladden. Om cirkulatorns nätsladd är den elektriska avstängningsanordningen, den måste alltid vara lättillgänglig.

Försäkra att strömsladdarna inte kommer i kontakt med avloppsanslutningarna eller rör.

Applicera aldrig spänning till någon av badets kommunikationsanslutningar.

Försäkra att dina rör uppfyller max kraven för tryck och temperatur.

Försäkra att alla elektriska och ev. kommunikationsanslutningar har slutförts innan uppstart.

Kylmedium som används är tyngre än luft och kommer, om en läcka uppstår, att tränga ut syre vilket orsakar medvetlöshet. Kontakt med läckande kylmedium orsakar brännskador på hud. Se cirkulatorns namnskytt för typ av kylmedium som används och sedan tillverkarens aktuella US Säkerhetsdatablad (SDS), tidigare kallat MSDS, och EU Säkerhetsdatablad för ytterligare information.

Försäkra att behållarens tömningsportar är stängda och att alla avloppsanslutningar är säkrade. Försäkra även att alla rester avlägsnas innan påfyllning.

För att undvika spill ska man placera behållarna i badet innan påfyllning.

Använd aldrig badet utan vätska i behållaren.

Oljebaserade vätskor expanderar vid uppvärmning. Undvik överfyllning av behållaren.

Använd endast godkända vätskor som listas i handboken. Användning av andra vätskor upphäver garantin. Använd aldrig 100 % glykol.

När man använder vatten över 80°C så ska man övervaka vätskenivån noga, regelbunden påfyllning kommer att vara nödvändig. Det skapar även ånga.

Vatten/glykolblandningar kräver påfyllning av rent vatten. I annat fall så kommer glykolhalten att öka vilket resulterar i hög viskositet och dålig prestanda.

Utöver vatten, innan man använder en godkänd vätska, eller vid underhåll där man troligen kommer i kontakt med vätskan, ska man referera till tillverkarens SDS och EU Säkerhetsdatablad för försiktighetsåtgärder vid hantering.

Försäkra att vätskan inte kan generera giftiga gaser. Brandfarliga gaser kan samlas vid användning av vätskan.

När man använder etylenglykol och vatten så ska man regelbundet kontrollera vätskans koncentration och pH-värde. Ändringar i koncentration och pH-värde kan påverka systemets prestanda.

Försäkra avstängningstemperaturen för övertemperatur är lägre än den valda vätskans flampunkt.

Den högsta driftstemperaturen, enligt EN 61010 (IEC 1010), måste vara begränsad till 25°C under flampunkten för badets vätska.

Försäkra att vätskan har en säker temperatur (under 40°C) innan hantering eller tömning.

Använd aldrig skadad eller läckande utrustning, eller med skadade sladdar.

Använd aldrig badet utan vätska i behållaren.

Använd aldrig badet eller lägg till vätska i behållaren med panelerna borttagna.

Rengör inte kylaren med rengöringsmedel. Använd en mjuk trasa och vatten.

Töm behållaren innan transport och/eller förvaring i temperaturer nära eller under fryspunkten.

Stäng alltid av badet och koppla bort strömförsörjningen innan det flyttas eller innan service eller underhållsprocedureer. Överlåt service och reparationer till en behörig tekniker.

Transportera badet varsamt. Plötsliga ryck eller fall kan skada dess komponenter.

Användaren är ansvarig för rengöringen om farliga material spills ut. Konsultera med tillverkaren gällande rengöring och för kompatibilitet med rengöringsmedel.

Om badet ska transporteras och/eller lagras i kalla temperaturer så måste det först tömmas och sköljas med en 50/50-blandning av glykol/vatten.

Urtågning ur drift för endast utföras av behörig återförsäljare med certifierad utrustning. Alla gällande bestämmelser måste följas.

Installations-, drift- eller underhållsprocedureer, förutom de som beskrivs i handboken, kan resultera i riskfyllda situationer och upphäver tillverkarens garanti.

För Sahara-bad, samt fristående immersionscirkulatorer, ska man använda den medföljande toppmuttern och brickan för att fästa jordningsbandet till metalltankens topp.

Använd aldrig badet när immersionscirkulatorn är borttagen.

Montera inte immersionscirkulatorn bakåtvänd; nätsladden kan komma i kontakt med behållarens vätska.

Bad med transparent akryl- och polyfenylenoxid (PPO) används endast med vatten.

Justera badets programvara för kompatibilitet med den valda vätskan.

## Installation för Arctic, Glacier och Sahara Badcirkulatorer:

Försäkra att strömsladdarna inte kommer i kontakt med avloppsanslutningarna eller rör.

För kylda bad så installerar man den medföljande skärmade kabeln RJ45 mellan immersionscirkulatorn och badets RJ45-anslutningar (liknande Ethernet). Detta är nödvändigt för korrekt drift.

För kylda bad så installerar man nätsladden från anslutningen på styrenhetens baksida, A, till anslutningen på baksidan av det kylda badet, B. Anslut badets nätsladd, C, till ett jordat eluttag.

För kylda bad så får man aldrig ansluta styrenhetens Strömkontakt, A, till ett eluttag. Anslut aldrig Strömkontakt, B, till något annat än en immersionscirkulator.

För icke kylda bad, så ansluter man badets nätsladd, C, till ett jordat eluttag.

Avloppsanslutningarna för extern cirkulation sitter på baksidan av immersionscirkulatorn. ● → är returflödet från den externa applikationen. ● → är utloppsflödet till den externa applikationen (matningssida). Anslutningarna är 16 mm O.D. Avlägsna förbandets muttrar och plattor för att installera de 8 mm eller 12 mm slanghullingarna och klämmorna som medföljer cirkulatorn.

För att förebygga skador på cirkulatorns rör så ska man använda en 19 mm nyckel när man tar bort/ installerar anslutningarna.

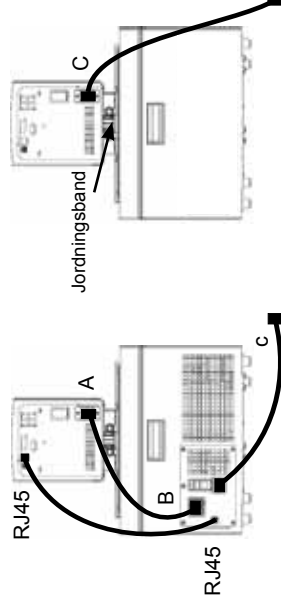

## **Fluorinated Greenhouse Gases**

The following information is included to comply with REGULATION (EU) No 517/2014 OF THE EUROPEAN PARLIAMENT AND OF THE COUNCIL of 16 April 2014 on fluorinated greenhouse gases:

**This product contains fluorinated greenhouse gases in a hermetically sealed system.**

**If a leak in the sealed system is detected, the operator shall repair without undue delay.**

Refer to the F-Gas Declaration of Conformity for additional information.

## **Fluorierte Treibhausgase**

Die folgende Information ist in diesen Unterlagen gemäß der VERORDNUNG (EU) Nr. 517/2014 DES EUROPÄISCHEN PARLAMENTS UND DES RATES vom 16. April 2014 über fluorierte Treibhausgase enthalten.

**Dieses Produkt enthält fluorierte Treibhausgase in einem hermetisch geschlossenen System.**

**Wird ein Leck im geschlossenen System entdeckt, muss der Anwender dieses unverzüglich reparieren.**

## **Gaz à effet de serre fluorés**

Les informations suivantes sont fournies de façon à respecter la RÉGLEMENTATION (UE) N° 517/2014 DU PARLEMENT EUROPÉEN ET DU CONSEIL datée du 16 avril 2014 et portant sur les gaz à effet de serre fluorés :

**Ce produit contient des gaz à effet de serre fluorés intégrés à un système hermétiquement scellé.**

**Toute fuite détectée dans le système scellé doit être réparée immédiatement par l'opérateur.**

## **Fluorerade växthusgaser**

Följande information finns med för att efterleva EUROPAPARLAMENTETS OCH RÅDETS FÖRORDNING (EU) nr. 517/2014 av den 16 april 2014 om fluorerade växthusgaser:

**Den här produkten innehåller fluorerade växthusgaser i ett hermetiskt förseglat system.**

**Om en läcka i det förseglade systemet identifieras, ska operatören reparera det utan dröjsmål.**

## **Gases de efecto invernadero fluorados**

La siguiente información se incluye de acuerdo con la REGULACIÓN (UE) N.º. 517/2014 DEL PARLAMENTO Y EL CONSEJO EUROPEO el 16 de abril de 2014 sobre gases de efecto invernadero fluorados:

**Este producto contiene gases de efecto invernadero en un sistema sellado herméticamente.**

**Si se detecta una fuga en el sistema sellado, el operador la reparará sin ninguna demora indebida.**

## **Fluorovani gasovi sa efektom staklene bašte**

Sledeće informacije su uključene u skladu sa UREDBOM (EU) br. 517/2014 EVROPSKOG PARLAMENTA I SAVETA od 16. aprila 2014. o fluorovanim gasovima sa efektom staklene bašte:

**Ovaj proizvod sadrži fluorovane gasove sa efektom staklene bašte u hermetički zatvorenom sistemu.**

**Ako se otkrije curenje iz zatvorenog sistema, korisnik mora popraviti kvar bez nepotrebnog odlaganja.**

## **Fluorirani toplogredni plini**

Informacije v nadaljevanju so vključene za izpolnitev zahtev iz UREDBE (EU) ŠT. 517/2014 EVROPSKEGA PARLAMENTA IN SVETA z dne 16. aprila 2014 o fluoriranih toplogrednih plinih:

**Ta izdelek vsebuje fluorirane toplogredne pline v hermetično zaprtem sistemu.**

**Če se ugotovi uhajanje plinov iz zaprtega sistema, ga upravljavec brez nepotrebnega odlašanja popravi.**

## **Fluorované skleníkové plyny**

Nasledujúce informácie sú tu uvedené z dôvodu súladu s NARIADENÍM (EÚ) Č. 517/2014 EURÓPSKEHO PARLAMENTU A RADY zo 16. apríla 2014 o fluorovaných skleníkových plynoch:

**Tento produkt obsahuje fluorované skleníkové plyny v hermeticky uzavretom systéme.**

**Ak dôjde v uzavretom systéme k únikom, operátor ho musí bez zbytočného oneskorenia opraviť.**



## **Gazele fluorurate cu efect de ser**

Următoarele informații sunt redactate în conformitate cu REGULAMENTUL (UE) NR. 517/2014 AL PARLAMENTULUI EUROPEAN I AL CONSILIULUI din 16 aprilie 2014 privind gazele fluorurate cu efect de seră:

**Acest produs conține gaze fluorurate cu efect de seră închise într-un sistem ermetic.**

**În cazul în care se detectează o scurgere la sistemul etanșat, operatorul trebuie să efectueze reparațiile necesare fără întârzieri nejustificate.**

## **Gases fluorados com efeito de estuf**

As seguintes informações foram incluídas para efeitos de conformidade com o REGULAMENTO (UE) N.º 517/2014 DO PARLAMENTO E CONSELHO EUROPEUS de 16 de abril de 2014 relativo aos gases fluorados com efeito de estufa:

**Este produto contém gases fluorados com efeito de estufa num sistema hermeticamente fechado.**

**Em caso de deteção de fuga no sistema fechado, o operador deverá repará-la sem atraso injustificado.**

## **Fluorowane gazy cieplarniane**

Poniższa informacja została zamieszczona w celu spełnienia wymagań określonych w ROZPORZĄDZENIU PARLAMENTU EUROPEJSKIEGO I RADY (UE) NR 517/2014 z 16 kwietnia 2014 roku w sprawie fluorowanych gazów cieplarnianych:

**Ten produkt zawiera flurowowane gazy cieplarniane w hermetycznie zamkniętym układzie.**

**W przypadku stwierdzenia wycieku z hermetycznie zamkniętego układu operator ma obowiązek dokonania naprawy urządzenia bez zbędnej zwłoki.**

## **Gefluoreerde broeikasgassen**

De volgende informatie is toegevoegd om te voldoen aan VERORDENING (EU) Nr. 517/2014 VAN HET EUROPEES PARLEMENT EN DE RAAD van 16 april 2014 betreffende gefluoreerde broeikasgassen:

**Dit product bevat gefluoreerde broeikasgassen in een hermetisch afgesloten systeem.**

**Indien er een lek wordt gedetecteerd in het afgesloten systeem, dient de gebruiker deze te repareren zonder onnodige vertraging.**

## **Gassijiet Fluworurati b'Effett ta' Serra**

L-informazzjoni li ġejja hi inluża biex tikkonforma mar-REGOLAMENT (UE) Nru 517/2014 TAL-PARLAMENT EWROPEW U TAL-KUNSILL tas-16 ta' April 2014 dwar gassijiet fluworurati b'effett ta' serra:

**Dan il-prodott fih gassijiet fluworurati b'effett ta' serra f'sistema ssiġillata ermetikament.**

**Jekk tinstab tnixxija fis-sistema ssiġillata, l-operatur għandu jsewwi mingħajr dewmien bla bżonn.**

## **Fluor tas siltumn cefekta g zes**

Turpmāk norādītā informācija ir iekļauta, lai nodrošinātu atbilstību EIROPAS PARLAMENTA UN PADOMES REGULAI (ES) Nr. 517/2014 (2014. gada 16. aprīlis) par fluorētām siltumnīcefekta gāzēm.

**Šis izstrādājums satur fluorētas siltumnīcefekta gāzes hermētiski noslēgtā sistēmā.**

**Ja hermētiski noslēgtajā sistēmā tiek konstatēta noplūde, operators to salabo bez nepamatotas kavēšanās.**

## **Fluorintos šiltnamio efekt sukelian ios dujos**

Toliau pateikta informācija yra įtraukta, kad būtų laikomasi 2014 m. balandžio 16 d. EUROPOS PARLAMENTO IR TARYBOS REGLAMENTO (ES) Nr. 517/2014 dėl fluorintų šiltnamio efekto sukeliančių dujų.

**Hermetiškai sandarioje šio produkto sistemoje yra fluorintų šiltnamio efekto sukeliančių dujų.**

**Jei aptinkamas sandarios sistemos nuotėkis, operatorius nedelsdamas turi jį suremontuoti.**

## **Gas fluorurati a effetto serra**

Si includono le seguenti informazioni in conformità con il REGOLAMENTO (UE) N. 517/2014 DEL PARLAMENTO EUROPEO E DEL CONSIGLIO del 16 aprile 2014 sui gas fluorurati a effetto serra:

**Il presente prodotto contiene gas fluorurati a effetto serra all'interno di un sistema a chiusura ermetica.**

**In caso di perdita del sistema a chiusura ermetica, l'operatore dovrà prontamente provvedere alla riparazione.**

## **Fluortartalmú üvegházhatású gázok**

A következő tájékoztatás az EURÓPAI PARLAMENT ÉS A TANÁCS (EU) 517/2014. SZÁMÚ, 2014. április 16-i, a fluortartalmú üvegházhatású gázokkal kapcsolatos RENDELETÉBEN előírtak teljesítése érdekében került a dokumentumba:

**A termék fluortartalmú üvegházhatású gázokat tartalmaz, hermetikusan zárt rendszerben.**

**Ha a zárt rendszerben szivárgás jelentkezik, az üzemeltető köteles a lehető leghamarabb megszüntetni azt.**

## **Fluorirani stakleni ki plinovi**

Informacije navedene u nastavku u skladu su s UREDBOM (EU) br. 517/2014 EUROPSKOG PARLAMENTA I VIJEĆA od 16. travnja 2014. o fluoriranim stakleničkim plinovima:

**Ovaj proizvod sadrži fluorirane stakleničke plinove u hermetički zatvorenom sustavu.**

**Ako se u hermetički zatvorenom sustavu otkrije propuštanje, operater ga mora popraviti bez nepotrebne odgode.**

## **Gáis Cheaptha Teasa Fhluairínithe**

Áirítear an fhaisnéis a leanas chun RIALACHÁN (AE) Uimh. 517/2014 Ó PHARLAIMINT NA hEORPA AGUS ÓN gCOMHAIRLE an 16 Aibreán 2014 maidir le gáis cheaptha teasa fhluairínithe a chomhlíonadh:

**Cuimsíonn an táirgeadh seo gáis cheaptha teasa fhluairínithe i gcóras atá séalaithe go heirméiteach.**

**Má bhraitear sceitheadh sa chóras séalaithe, déanfaidh an t-oibreoir deisiúchán gan mhoill.**

## **Fluoratut kasvihuonekaasut**

Seuraavat tiedot on lisätty, jotta noudatetaan 16. päivänä huhtikuuta 2014 fluoratuista kasvihuonekaasuista annettua EUROOPAN PARLAMENTIN JA NEUVOSTON ASETUSTA (EU) N:o 517/2014:

**Tämä tuote sisältää fluorattuja kasvihuonekaasuja hermeettisesti tiivistetyssä järjestelmässä.**

**Jos tiivistetyssä järjestelmässä havaitaan vuoto, käyttäjän on korjattava se viipymättä.**

## **Fluoritud kasvuhoo-negaasid**

Alljärgnev teave on lisatud, et järgida EUROOPA PARLAMENDI JA NÕUKOGU MÄÄRUST NR 517/2014 16. aprill 2014 fluoritud kasvuhoo-negaaside kohta.

**See toode sisaldab hermeetiliselt suletud süsteemis fluoritud kasvuhoo-negaase.**

**Lekke tuvastamise korral hermeetiliselt suletud süsteemis peab operaator viivitamatult lekke remontima.**

**μ π**

Οι ακόλουθες πληροφορίες περιλαμβάνονται για λόγους συμμόρφωσης με τον ΚΑΝΟΝΙΣΜΟ (ΕΕ) αριθ. 517/2014 ΤΟΥ ΕΥΡΩΠΑΪΚΟΥ ΚΟΙΝΟΒΟΥΛΙΟΥ ΚΑΙ ΤΟΥ ΣΥΜΒΟΥΛΙΟΥ της 16ης Απριλίου 2014 για τα φθοριούχα αέρια του θερμοκηπίου:

**Το παρόν προϊόν περιέχει φθοριούχα αέρια του θερμοκηπίου σε ερμητικά σφραγισμένο σύστημα.**

**Σε περίπτωση ανίχνευσης διαρροής στο σφραγισμένο σύστημα, ο χειριστής προβαίνει σε επιδιόρθωση χωρίς αδικαιολόγητη καθυστέρηση.**

## **Fluorholdige drivhusgasser**

Nedenstående oplysninger er medtaget som dokumentation for overholdelse af EUROPA-PARLAMENTET OG RÅDETS FORORDNING (EU) nr. 517/2014 af 16. april 2014 om fluorholdige drivhusgasser:

**Dette produkt indeholder fluorholdige drivhusgasser i et hermetisk forsejlet system.**

**Hvis der konstateres en lækage i det forseglede system, skal operatøren hurtigst muligt reparere lækagen.**

## **Fluorované skleníkové plyny**

Následující informace jsou zahrnuty pro dodržení PŘEDPISU (EU) č. 517/2014 EVROPSKÉHO PARLAMENTU A RADY ze dne 16. dubna 2014 o fluorovaných skleníkových plynech:

**Tento výrobek obsahuje fluorované skleníkové plyny v hermeticky utěsněném systému.**

**Pokud je v systému zjištěn únik, provozovatel ho musí okamžitě opravit.**

## **Флуорсъдържащи парникови газове**

Следната информация е включена в съответствие с РЕГЛАМЕНТ (ЕС) № 517/2014 НА ЕВРОПЕЙСКИЯ ПАРЛАМЕНТ И НА СЪВЕТА от 16 април 2014 г. за флуорсъдържащите парникови газове:

**Този продукт съдържа флуорсъдържащи парникови газове в херметично затворена система.**

**Ако в затворената система бъде засечен теч, операторът трябва незабавно да извърши ремонт.**

**Declaration of conformity with Article 14 of Regulation (EU) No 517/2014 of the European Parliament and of the Council**

We, Thermo Fisher Scientific (Asheville) LLC, F-Gas Portal Registration Number 23643, declare under our sole responsibility that when placing on the market pre-charged equipment, which we import to or manufacture in the Union, the hydrofluorocarbons contained in that equipment are accounted for within the quota system referred to in Chapter IV of Regulation (EU) No 517/2014 as:

We hold authorisation(s) issued in accordance with Article 18(2) of Regulation (EU) No 517/2014 and registered in the registry referred to in Article 17 of that Regulation, at the time of release for free circulation to use the quota of a producer or importer of hydrofluorocarbons subject to Article 15 of Regulation (EU) No 517/2014 that cover(s) the quantity of hydrofluorocarbons contained in the equipment.

The hydrofluorocarbons contained in the equipment have been placed on the market in the Union, subsequently exported and charged into the equipment outside the Union, and the undertaking that placed the hydrofluorocarbons on the market made a declaration stating that the quantity of hydrofluorocarbons has been or will be reported as placed on the market in the Union and that it has not been and will not be reported as direct supply for export in the meaning of Article 15(2)(c) of Regulation (EU) No 517/2014 pursuant to Article 19 of Regulation (EU) No 517/2014 and Section 5C of the Annex to Commission Implementing Regulation (EU) No 1191/2014.

January 1, 2017

\_\_\_\_\_  
Date

Mark Pearson, Director Global Regulatory Affairs

\_\_\_\_\_  
[name and position of legal representative]



\_\_\_\_\_  
[signature of legal representative]

Manufacturer:

Thermo Fisher Scientific (Asheville) LLC  
275 Aiken Road  
Asheville, NC 28804  
U.S.A.

EU Only Representative:

Thermo Electron LED GmbH  
Robert-Bosch-Strasse 1  
D-63505 Langenselbold  
Germany  
**VAT ID Number: DE 812 403 137**

## Section 2 General Information

### Description and Intended Use

The Thermo Scientific ADVANCED Series of Heated Immersion Circulators are used with refrigerated and heated baths. All immersion circulators can pump to an external system. All circulators have a digital display and easy-to-use touch pad, five programmable setpoint temperatures, acoustic and optical alarms, and offer adjustable high temperature protection.

The circulator is designed for use in a clean laboratory environment and in accordance with the Letter of Compliance located at the end of this manual.

### ADVANCED Heated Immersion Circulators

	AC150	AC200
<b>Temperature Range</b> °C* °F	Ambient +13 to +150 Ambient +23 to +302	Ambient +13 to +200 Ambient +23 to +392
<b>Temperature Stability</b> °C	±0.01	±0.01
<b>Heater Capacity</b> 230V/115V watts	2000/1200	2000/1200
<b>Circulator Dimensions</b> (H x W x D) mm inches	372 x 165 x 199 14.6 x 6.4 x 7.8	372 x 165 x 199 14.6 x 6.4 x 7.8
<b>Reservoir Depth Requirement</b> mm inches	150 5.9	150 5.9
<b>Fill Level</b> mm (from top of reservoir)	57..22	57..22
<b>Required Reservoir Depth</b> mm	150	150
<b>Net Weight</b> kg/lb	4.2/9.3	4.2/9.3
<b>Pumping Capacity</b> Max flow rate lpm/gpm Max pressure (mbar/psi) Max suction Pump speed steps	20/5.3 475/6.89 330/4.85 3	20/5.3 475/6.89 330/4.85 3
<b>Electrical Requirements</b> (Voltage ±10%)	100 V/50 Hz 100 V/60 Hz or 115 V/60 Hz or 230 V/50..60 Hz	100 V/50 Hz 100 V/60 Hz or 115 V/60 Hz or 230 V/50..60 Hz
<b>Connectivity</b> Remote sensor port USB port Multi function port RS232/RS485/Ethernet/LAN Analog I/O	Yes No No Optional No	Yes Yes Yes Optional Optional

- Performance specifications established in accordance with DIN 12876 (using water at 70°C).
- \* The lowest usable temperature may be 13°C (23°F) warmer than room temperature, lower temperature ranges require supplemental cooling.
- The maximum bath wall thickness for circulators that have a factory installed clamp is 26 mm.
- Thermo Fisher Scientific reserves the right to change specifications without notice.



## ARCTIC Refrigerated/Heated Bath Circulator Specifications

Stainless Steel Refrigerated/Heated Bath Circulators			
	A10	A25	A45HC
<b>AC150 Temperature Range</b> °C °F	-10 to 100 14 to 212	-25 to 150 -13 to 302	
<b>AC200 Temperature Range</b> °C °F	-10 to 100 14 to 212	-25 to 200 -13 to 392	-45 to 200 -49 to 392
<b>Bath Volume</b> liters gallons	4 - 6 1.1 - 1.6	7 - 12 1.8 - 3.2	7 - 12 1.8 - 3.2
<b>Cooling Capacity</b> watts	240	500	900
<b>Refrigerant</b>	R134a	R134a	R290
<b>Overall Dimensions</b> (H x W x D)* mm inches	670 x 220 x 414 26.4 x 8.7 x 16.3	749 x 273 x 483 29.5 x 10.7 x 19.0	787 x 385 x 580 31.0 x 15.2 x 22.8
<b>Work Area Dimensions</b> (D x W x L)* mm inches	150 x 137 x 124 5.9 x 5.4 x 4.9	200 x 173 x 184 8.0 x 6.8 x 7.2	200 x 173 x 184 8.0 x 6.8 x 7.2
<b>Net Weight</b> kg/lb	27.5/60.6	36.1/79.5	52.2/115
<b>Electrical Requirements**</b> (Voltage ±10%)	100 V/50 Hz 100 V/60 Hz or 115 V/60 Hz or 230 V/50 Hz		115 V/60 Hz 230 V/50 Hz

Stainless Steel Refrigerated/Heated Bath Circulators		
	A10B	A25B
<b>AC150 Temperature Range</b> °C °F	-10 to 100 14 to 212	-25 to 150 -13 to 302
<b>AC200 Temperature Range</b> °C °F	-10 to 100 14 to 212	-25 to 200 -13 to 392
<b>Bath Volume</b> liters gallons	17 - 30 4.5 - 7.9	13 - 21 3.4 - 5.5
<b>Cooling Capacity</b> watts	250	500
<b>Refrigerant</b>	R134a	R134a
<b>Overall Dimensions</b> (H x W x D)* mm inches	509 x 429 x 913 20.0 x 16.9 x 35.9	778 x 324 x 541 30.6 x 12.8 x 21.3
<b>Work Area Dimensions</b> (D x W x L)* mm inches	200 x 297 x 365 7.9 x 11.7 x 13.4	233 x 224 x 244 9.2 x 8.8 x 9.6
<b>Net Weight</b> kg/lb	44.5/97.9	42.3/93.1
<b>Electrical Requirements**</b> (Voltage ±10%)	100 V/50 Hz 100 V/60 Hz or 115 V/60 Hz or 230 V/50 Hz	

\*See page 2-5. Add ~26 mm (1 inch) to D for drain fitting.

\*\*See Section 3 for additional information.

- Thermo Fisher Scientific reserves the right to change specifications without notice.

### Cooling Capacity

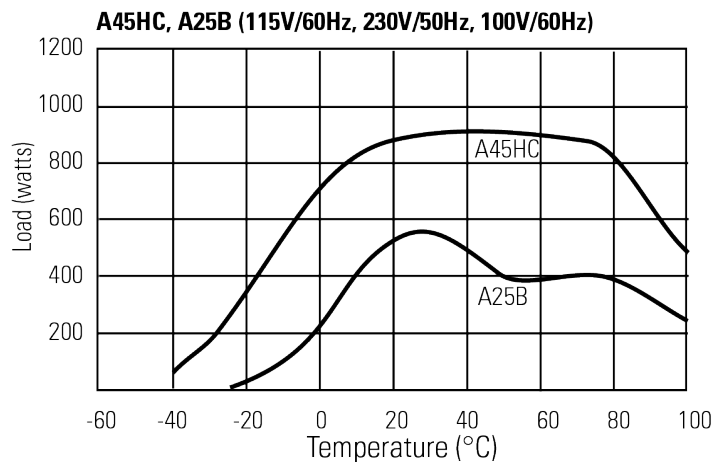
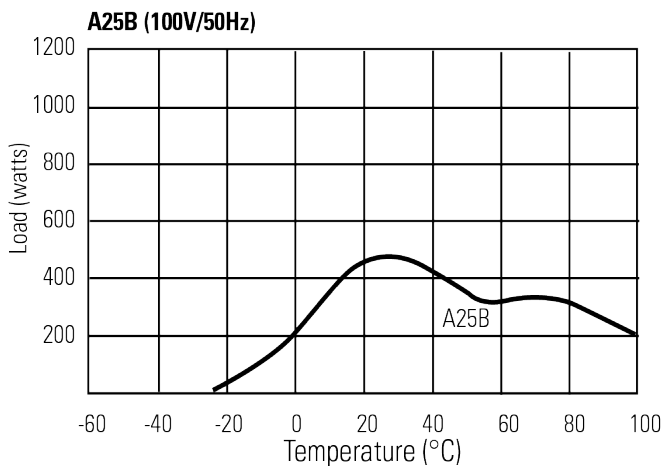
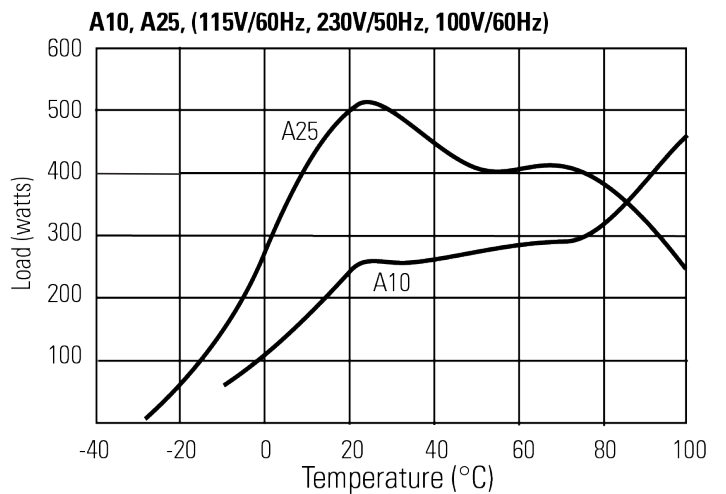
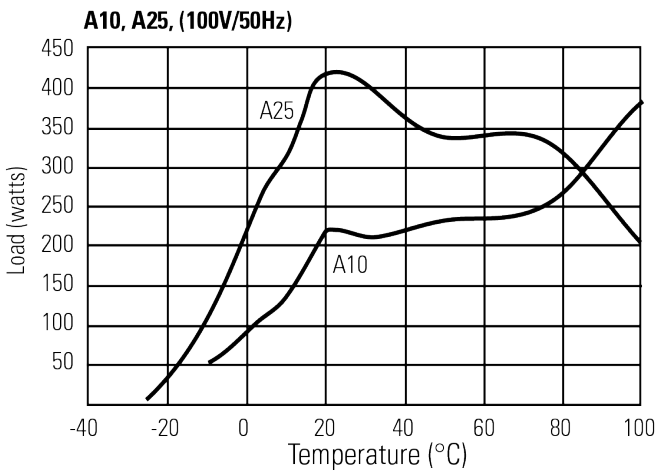
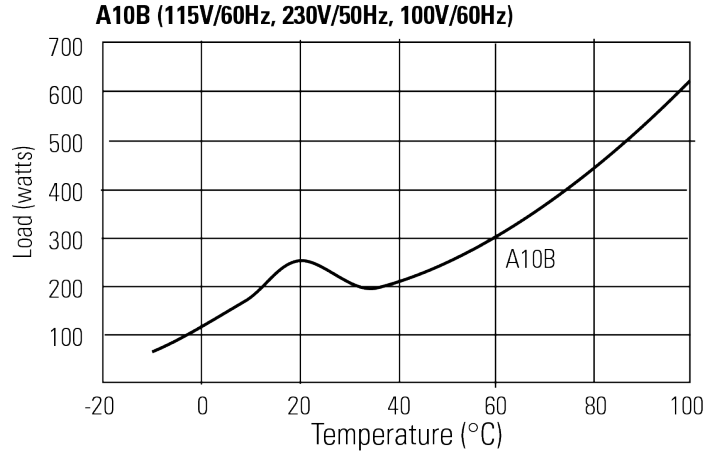
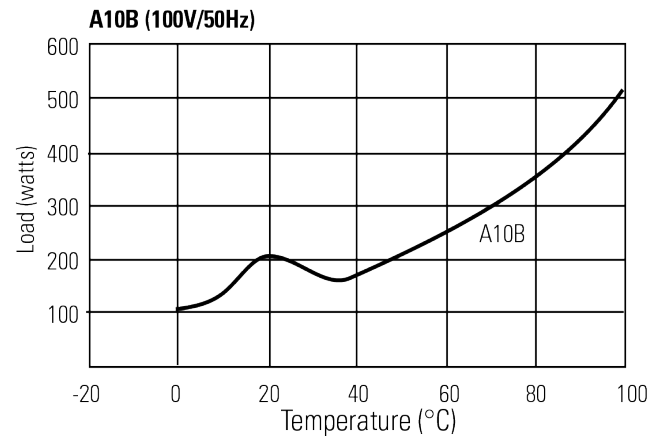

Specifications obtained at sea level using water (above +5°C to +90°C) or a fluid with a specific heat of 2.3 kJ/kg-K or 0.55 Btu/lb-F (less than 5°C) as the recirculating fluid at a +20°C ambient condition, at nominal operating voltage. Other fluids, process temperatures, ambient temperatures, altitude or operating voltage will affect performance. The bath was operating with the lid closed and no heat load lid or any external circulation.

Minimum temperatures are only achieved with the above conditions. If your conditions vary from above, minimum temperature will most likely not be achieved.

Specifications are for reference only and are subject to change.

**Time to Temperature**

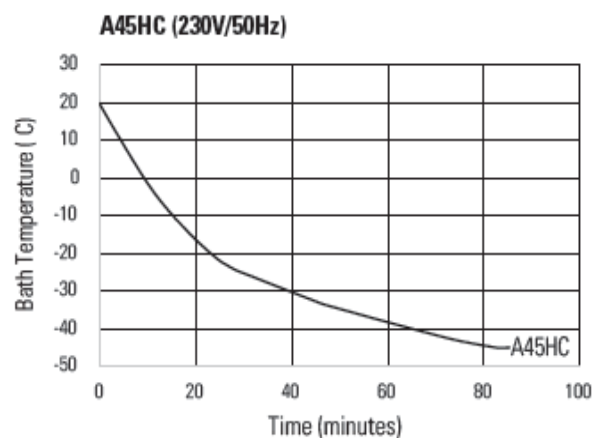
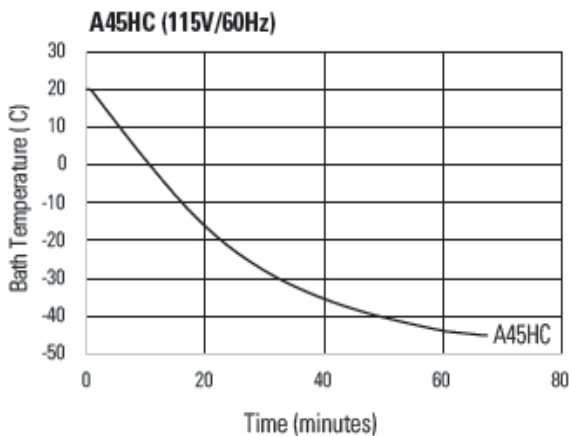
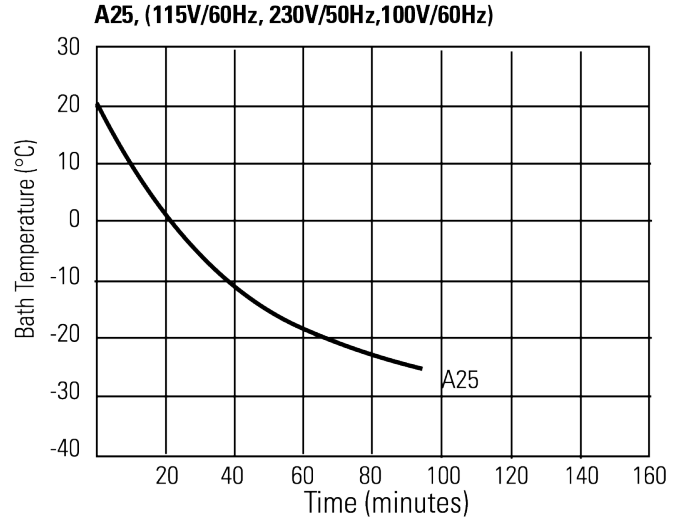
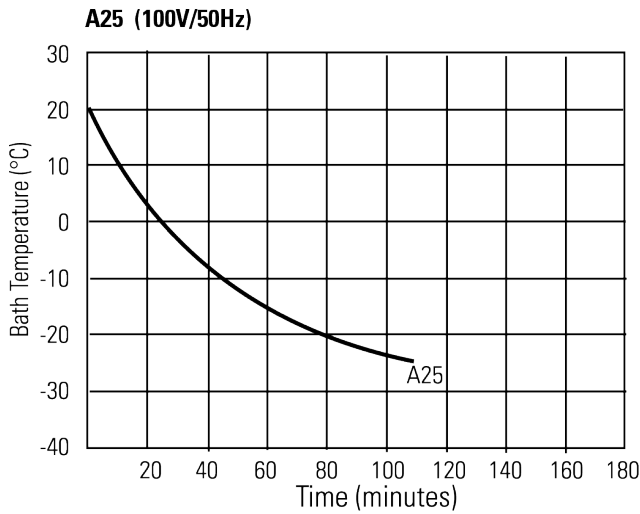
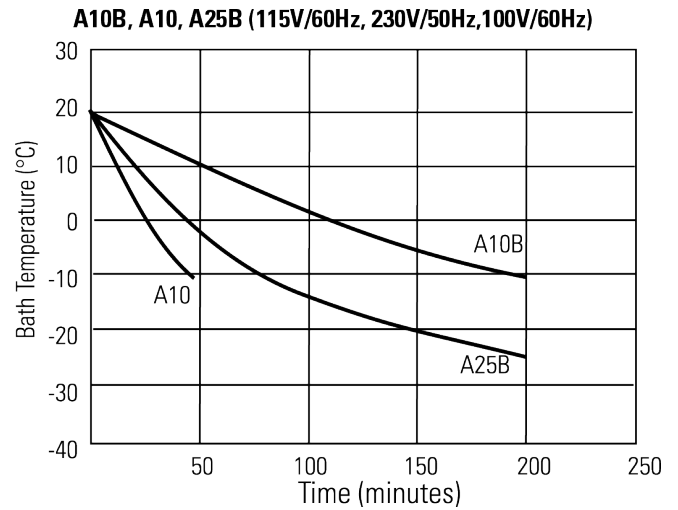
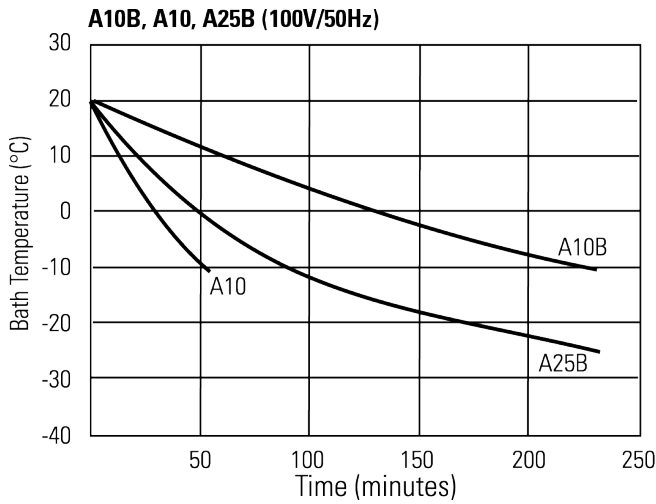

Specifications obtained at sea level using water (above +5°C to +90°C) or a fluid with a specific heat of 2.3 kJ/kg-K or 0.55 Btu/lb-F (less than 5°C) as the recirculating fluid at a +20°C ambient condition, at nominal operating voltage. Other fluids, process temperatures, ambient temperatures, altitude or operating voltage will affect performance. Pump specifications are nominal values of ±10%. Specifications are for reference only and are subject to change.

## SAHARA Heated Bath Circulator Specifications

Stainless Steel Bath Circulators		
	S7	S13
<b>AC150 Temperature Range</b> °C* °F*	Ambient +13 to 150 Ambient +23 to 302	Ambient +13 to 150 Ambient +23 to 302
<b>AC200 Temperature Range</b> °C* °F*	Ambient +13 to 200 Ambient +23 to 392	Ambient +13 to 200 Ambient +23 to 392
<b>Bath Volume</b> liters gallons	4 - 8 1.1 - 2.1	7 - 12 1.8 - 3.2
<b>Overall Dimensions</b> (H x W x D)** mm inches	494 x 235 x 428 19.5 x 9.2 x 16.7	494 x 321 x 428 19.5 x 12.6 x 16.7
<b>Work Area Dimensions</b> (D x W x L)** mm inches	200 x 154 x 112 7.9 x 6.1 x 4.4	200 x 293 x 112 7.9 x 9.4 x 4.4
<b>Net Weight</b> kg/lb	10.6/23.4	12.3/27.0

Stainless Steel Bath Circulators			
	S21	S45	S49
<b>AC150 Temperature Range</b> °C* °F*	Ambient +13 to 150 Ambient +23 to 302	Ambient +13 to 150 Ambient +23 to 302	Ambient +13 to 150 Ambient +23 to 302
<b>AC200 Temperature Range</b> °C* °F*	Ambient +13 to 200 Ambient +23 to 392	Ambient +13 to 150 Ambient +23 to 302	Ambient +13 to 200 Ambient +23 to 392
<b>Bath Volume</b> liters gallons	7 - 19 1.8 - 5.0	30 - 41 7.9 - 10.8	29 - 53 7.7 - 14.0
<b>Overall Dimensions</b> (H x W x D)** mm inches	447 x 381 x 628 17.6 x 15.0 x 24.7	594 x 381 x 628 23.4 x 15.0 x 24.7	494 x 579 x 746 19.5 x 22.8 x 29.4
<b>Work Area Dimensions</b> (D x W x L)** mm inches	150 x 297 x 312 5.9 x 11.7 x 12.3	300 x 298 x 312 11.8 x 11.7 x 12.3	200 x 498 x 430 7.9 x 19.6 x 16.9
<b>Net Weight</b> kg/lb	14.2/31.2	20.3/44.7	24.3/53.4

\*The lowest usable temperature may be 13°C (23°F) warmer than room temperature, lower temperature ranges require supplemental cooling

\*\*See page 2-5. Add ~26 mm (1 inch) to D for drain fitting.

\*\*\*See Section 3 for additional information.

- Thermo Fisher Scientific reserves the right to change specifications without notice.

**Time to Temperature**

**S7, S13 (115V - 1.2kW)**

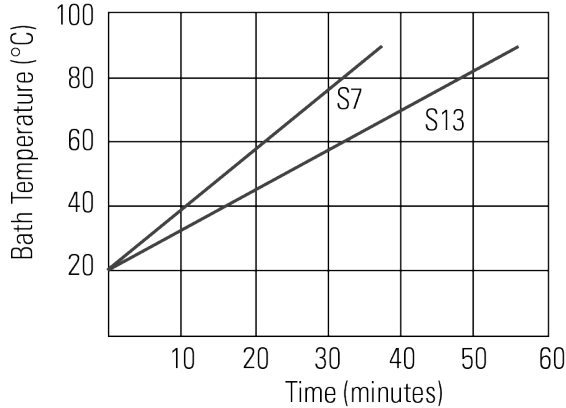

**S7, S13 (230V - 2kW)**

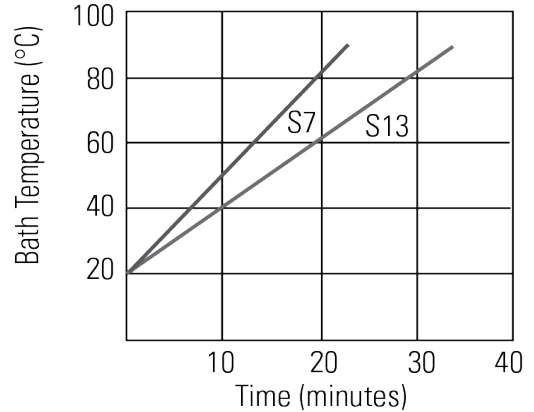

**S21 (115V - 1.2kW)**

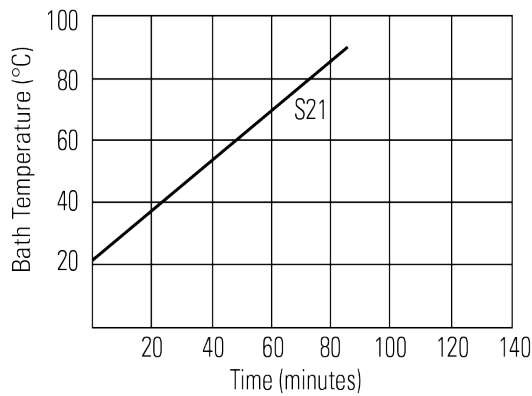

**S21 (230V - 2kW)**

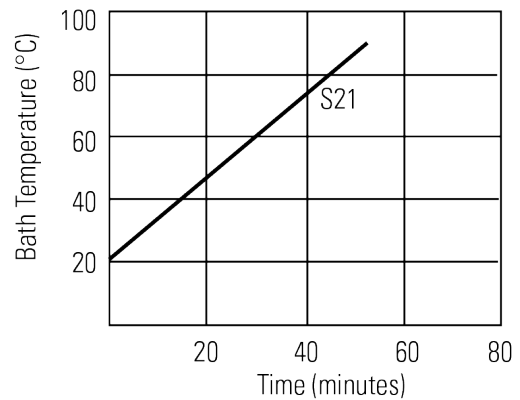

**S45, S49 (115V - 1.2kW)**

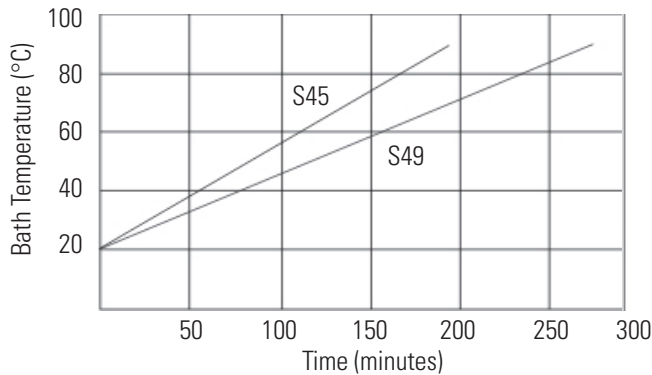

**S45, S49 (230V - 2kW)**

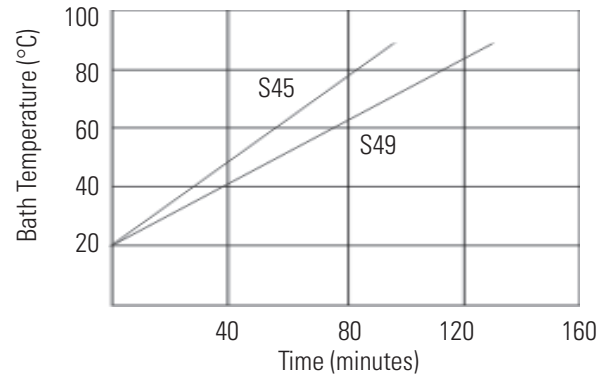

Specifications obtained at sea level using water (above +5°C to +90°C) or a fluid with a specific heat of 2.3 kJ/kg-K or 0.55 Btu/lb-F (less than 5°C) as the recirculating fluid at a +20°C ambient condition, at nominal operating voltage. Other fluids, process temperatures, ambient temperatures, altitude or operating voltage will affect performance. Pump specifications are nominal values of ±10%. Specifications are for reference only and are subject to change. Heat-up rates for the 100V baths will take approximately 25% longer than the 115V.



Water is the only approved fluid for polyphenylene oxide bath circulators. ▲

	Polyphenylene oxide (PPO) Bath Circulators	
	<b>S14P</b>	<b>S21P</b>
<b>Temperature Range</b> °C* °F*	Ambient +13 to 100 Ambient +23 to 212	Ambient +13 to 100 Ambient +23 to 212
<b>Bath Volume</b> liters gallons	8 - 14 2.1 - 3.7	13 - 21 3.4 - 5.5
<b>Overall Dimensions</b> (H x W x D)** mm inches	399 x 358 x 452 15.7 x 14.1 x 17.8	399 x 358 x 642 15.7 x 14.1 x 25.3
<b>Work Area Dimensions</b> (D x W x L)** mm inches	160 x 300 x 163 6.3 x 11.8 x 6.4	160 x 300 x 353 6.3 x 11.8 x 13.9
<b>Net Weight</b> kg/lb	6.3/13.9	6.6/14.5

\*The lowest usable temperature may be 13C (23F) warmer than room temperature, lower temperature ranges require supplemental cooling.

\*\*See page 2-5. Add ~13 mm (1/2 inch) to D for drain fitting.

- Thermo Fisher Scientific reserves the right to change specifications without notice.

## Wetted Materials

### ADVANCED Immersion Circulator

Viton  
EPDM  
Ceramic  
Ultem  
Vectra  
Stainless Steel

### Stainless Steel Baths/Circulators

Stainless Steel 316  
Stainless Steel 304  
EPDM  
Ryton (drain fitting)  
Zotek-N (cover seal)

### Polyphenylene oxide (PPO) Baths/Circulators

Polyphenylenoxid



## Section 3 Installation

### Ambient Conditions

Ambient Temperature Range	5°C to 40°C (41°F to 104°F)
Maximum Relative Humidity	80% for temperatures up to 31°C (88°F)*
Operating Altitude	Sea Level to 2000 meters (6560 feet)
Overvoltage Category	II
Pollution Degree	2
Degree of Protection	IP 20

\*decreasing linearly to 50% relative humidity at 40°C (104°F)

### Immersion Circulator Only

Ensure the label and small piece of Styrofoam securing the float switch are removed before using.

The circulator is designed for continuous operation and for indoor use.



**For stand-alone immersion circulators use the supplied nut and washer to secure the grounding strap to the top of the metal tank. See next page. ▲**



**Never place the circulator in a location where excessive heat, moisture, inadequate ventilation, or corrosive materials are present. ▲**



**Carefully install the circulator to ensure it does not fall into the bath or that its line cord does not make contact with the bath contents. ▲**

For immersion circulators equipped with a bridge:

- The bridge is designed to fit baths that are 400 mm to 800 mm wide.
- Slide the bridge support rods to the desired length and secure them in place with the supplied eight 3 mm Phillips Head screws.
- If possible, secure the bridge to your bath using the two supplied thumb-screws.
- The immersion depth is 75 to 145 mm (~3 to 5 <sup>3</sup>/<sub>4</sub> ").

Your bath container must be sturdy enough to support the weight of the assembly, approximately 3.8 kilograms (8.5 pounds). The circulator is designed for continuous operation and for indoor use only.

## Bath Circulator

Circulators are designed for continuous operation; and for indoor use.

The equipment normally ships with the immersion circulator mounted facing the reservoir. You may change the position  $\pm 90^\circ$  by removing the thumb screws, no tools are required.



**Do not mount the circulator backwards; the line cord could contact the reservoir fluid. ▲**

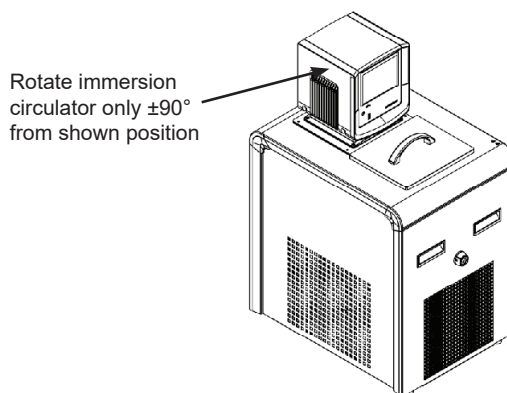

**Never place the circulator in a location where excessive heat, moisture, inadequate ventilation, or corrosive materials are present. ▲**



**Leave refrigerated baths in an upright position at room temperature ( $\sim 25^\circ\text{C}$ ) for 24 hours before starting. This will ensure the lubrication oil has drained back into the compressor. ▲**

## Grounding Strap and Nut



Sahara baths, and stand-alone circulators, require immersion circulator grounding.

**For Sahara baths, and stand-alone immersion circulators, use the supplied nut and washer to secure the grounding strap to the top of the metal tank. ▲**

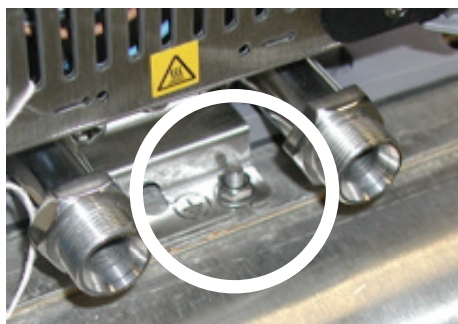

**A45HC units utilize a flammable refrigerant, risk of fire or explosion, do not use sharp objects to clean evaporator coil in the tank. ▲**

## Ventilation

All circulators except A45HC can operate with 0 clearance on two exhaust sides as long as the third exhaust side has unrestricted air flow. A45HC must have at least 25mm [1"] of clearance on both sides to comply with UL leak mitigation safety standards. Blocked ventilation increases the circulator's temperature, reduce its cooling capacity and, on refrigerated baths, eventually lead to premature compressor failure.

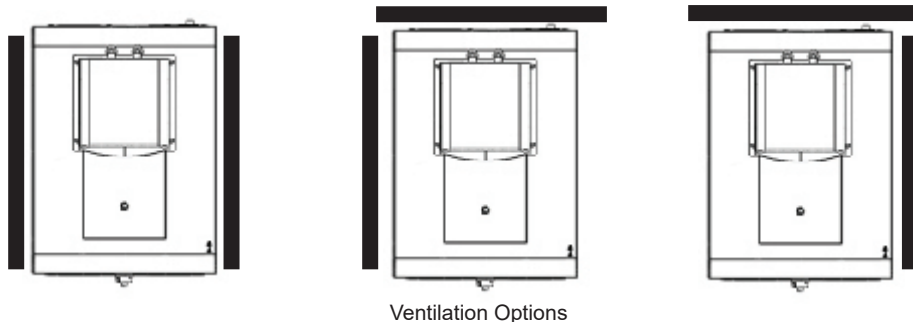

## Electrical Requirements



The circulator's construction provides protection against the risk of electrical shock by grounding appropriate metal parts. The protection will not function unless the power cord is connected to a properly grounded outlet. It is the user's responsibility to assure a proper ground connection is provided. ▲

EN 61000-3-11 Compliance: This equipment complies with EN/IEC 61000-3-11 provided that main power system impedance ( $Z_{max}$ ) is less than or equal to  $0.074\Omega + j0.046\Omega$  [ $0.074\Omega + 146 \mu H$ ] at the interface point between the user's supply connection and the public system. Consult with the local supply authority if necessary for system  $Z_{max}$  determination.



For Sahara baths, and stand-alone immersion circulators, use the supplied nut and washer to secure the grounding strap to the top of the metal tank. See previous page. ▲

The circulator is intended for use on a dedicated outlet. All circulators are equipped with automatic thermally-triggered 20 Amp circuit protector.

The circuit protector is designed to protect the circulator.

**Note** If the circuit protector activates allow the circulators to cool before resetting. Restart the circulator. Contact us if it activates again. ▲



The circulator's power cord is used as the disconnecting device, it must be easily accessible at all times. ▲

Refer to the bath nameplate on the rear, upper-left-hand corner of the bath for specific electrical requirements. Voltage deviations of  $\pm 10\%$  are permissible. The outlet must be rated as suitable for the total power consumption of the circulator, see next page.

**Note:** If a bath and immersion circulator were purchased separately, follow the electrical requirements listed on the bath nameplate. ▲

The following power options are available:

Bath	Volts <sup>1</sup> /Hertz/Phase	Amps <sup>2</sup>	Total Wattage	Plug Type
<b>A10</b>	115/60/1	11.5	1165	N5-15
	100/50-60/1	11.4	1120	N5-15
	230/50/1	10.3	2370	Country Specific
<b>A25</b>	115/60/1	11.7	1185	N5-15
	100/50-60/1	11.5	1135	N5-15
	230/50/1	10.4	2395	Country Specific
<b>A10B</b>	115/60/1	11.5	1165	N5-15
	100/50-60/1	11.4	1120	N5-15
	230/50/1	10.3	2370	Country Specific
<b>A25B</b>	115/60/1	11.7	1185	N5-15
	100/50-60/1	11.5	1135	N5-15
	230/50/1	10.4	2395	Country Specific
<b>A45HC</b>	115/60/1	14.4	1660	N5-20
	230/50/1	11.3	2600	Country Specific
<b>All Heated Baths/Circulators</b>	115/60/1	11.3	1300	N5-15
	100/50-60/1	10.0	1300	N5-15
	230/50/1	9.3	2135	Country Specific

- 1. Volts  $\pm 10\%$
- 2. Maximum amp draw

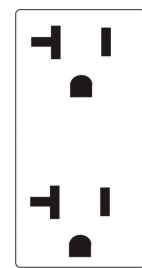

20 Amp Outlet  
(16 Amp)

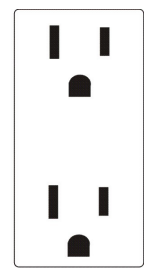

15 Amp Outlet  
(12 Amp)

**For refrigerated baths:**



**Ensure all communication and electrical connections are made prior to starting the circulator. ▲**

- Install the supplied RJ45 shielded cable between the immersion circulator and the bath RJ45 connectors (similar to Ethernet). **This is required for proper operation.**

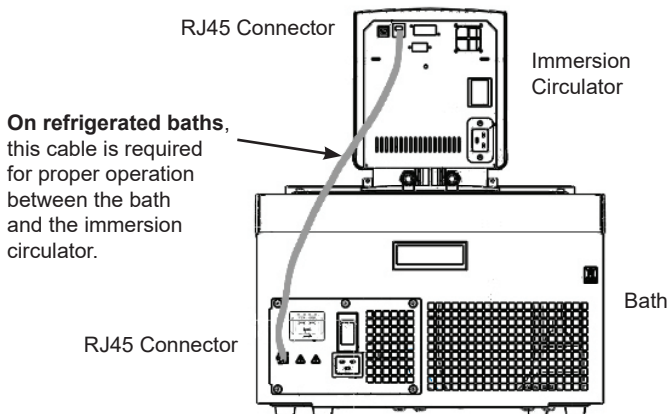

- Install the power cord from the connector on the rear of the controller, A, to the connector on the rear of the refrigerated bath, B.
- Connect the bath's power cord, C, to a grounded power outlet.



**For refrigerated baths, never connect controller power inlet, A, to a power outlet. Never connect power outlet, B, to anything but an immersion circulator. ▲**



**Ensure the cords do not come in contact with any of the plumbing connections or tubing. ▲**

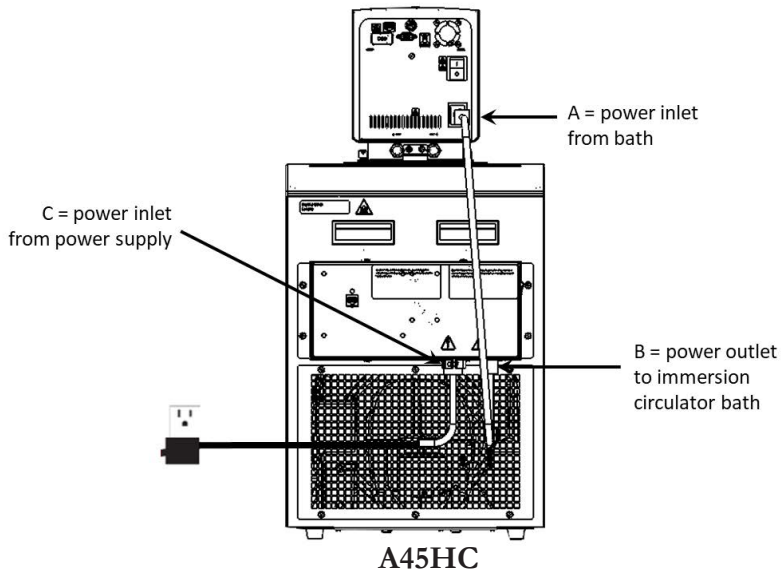

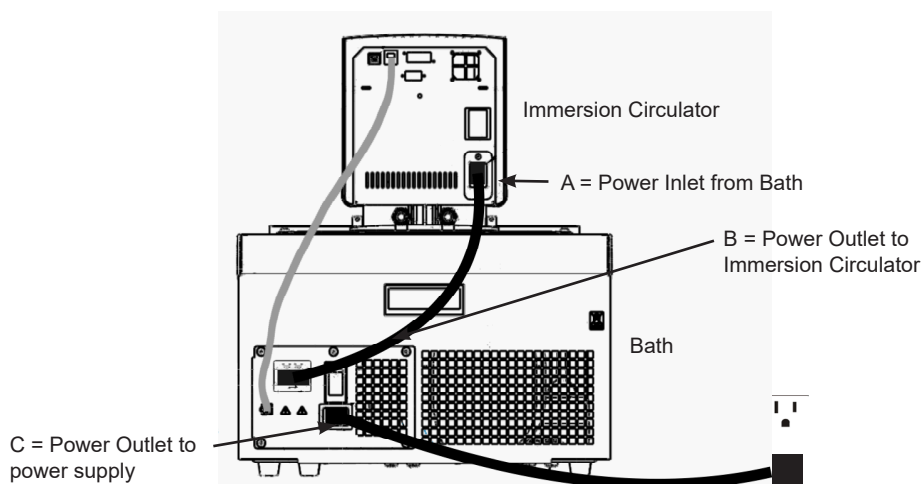

**For non-refrigerated baths:**

- Connect the bath's power cord, C, to a grounded power outlet.



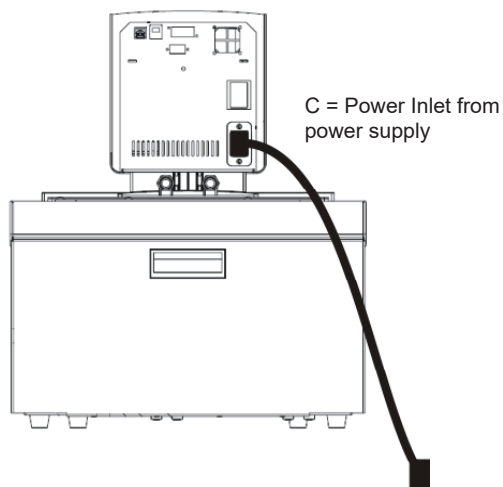

**Ensure the electrical cords do not come in contact with any of the plumbing connections or tubing. ▲**





## External Circulation

The plumbing connections for external circulation are located on the rear of the immersion circulator.  is the return flow from the external application.  is the outlet flow to the external application (supply side). The connections are 16 mm O.D. Remove the union nuts and plates to install the 8 mm or 12 mm hose barbs and clamps supplied with the circulator.

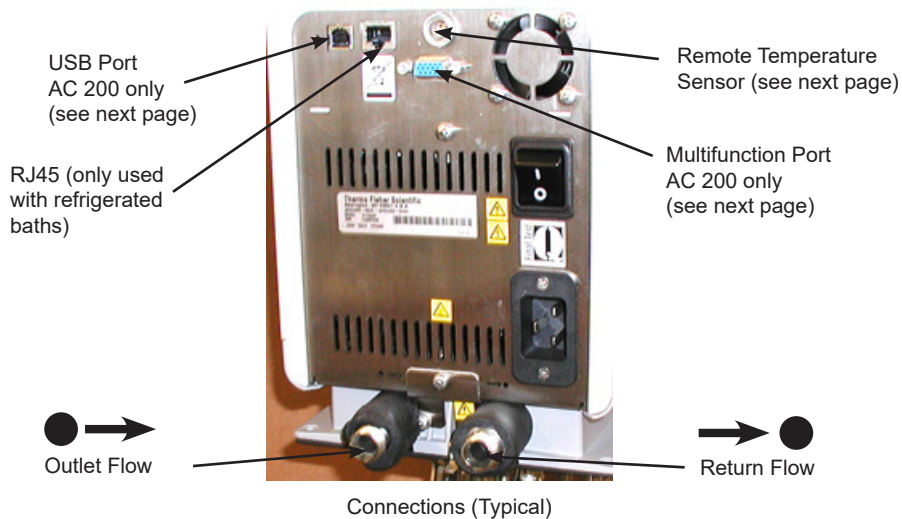

To prevent damage to the circulator's plumbing, use a 19 mm backing wrench when removing/installing the connections. ▲



## Remote Temperature Sensor



The remote temperature sensor on the rear of the immersion circulator requires a 4-pin connector that must mate to a LEMO # ECP.1S.304.CLL. The immersion circulator uses a 3 wire sensor, but a 4 wire sensor can be used (pins 3 and 4 are interconnected in the control head). The pin-out is:

Pin 1 and 2 = Pt100 +      Pin 3 and 4 = Pt100 -

See Section 4 for instructions to enable the remote sensor.

## Multifunction Port



AC 200s have a multifunction port on the rear of the immersion circulator that is used in conjunction with an *optional* accessory box to select and activate additional features. See Section 4 for additional information.

## USB Port

AC 200 only. If your computer does not automatically recognize the USB driver, installation instructions are provided in the Appendix.

## Tubing Requirements



**Ensure none of the tubing comes in contact with the power cord. ▲**

Tubing is normally used to connect the pump to an external application.

**Note** The maximum allowable length of tube depends largely on the size, form and material of the external vessel. The length of tube and its diameter, combined with the circulating capacity, have a large affect on the temperature stability. Whenever possible, use a wider tube diameter and place the application as close as possible to the circulator. ▲



**Extreme operating temperatures will lead to extreme temperatures on the tube surface, this is even more critical with metal nozzles. ▲**

- the required tube material depends on the heat transfer liquid used
- tubes must not be folded or bent
- after prolonged use, tubes may become brittle or they may get very soft, check them on a regular basis and replace if necessary
- secure all tube connections using clamps

When using the internal bath only, the plumbing connections can be closed with the supplied plate and union nuts.

## Tubing

Tubing for Thermo Scientific temperature control systems is optional. Please select the proper tubing from the table shown in Section 5.



**Ensure the tubing you select meets your maximum temperature and pressure requirements. ▲**

### Plastic and rubber tubing

If other plastic and rubber tubes are used, ensure that the tubes selected are fully suitable for the particular application, i.e., that they will not split, crack or become disengaged from their connections.

Connect the tubing using the supplied tube fittings for 8 or 12 mm i.d. They are attached to the plumbing connections with a supplied coupling nut.

We highly recommend using foam rubber insulation on the tubing and the fittings.

### Metal tubing

Thermo Scientific metal tubing (stainless steel insulated) offers a particularly high degree of safety and is suitable for both low and high temperatures/liquids.

The metal tubing is attached directly to the plumbing connections, gaskets are not required.



**Do not subject tubing to mechanical strain and ensure any specified bend radius is not exceeded. ▲**

Tubing is available in lengths of 0.5, 1.0 and 1.5 meters. Couplings for connecting tubes are also available.

The smallest opening inside the metal tubes is 10 mm. The metal tubing is provided with coupling nuts (M16 x 1, DIN 12 879, part 2) at either end.

## Approved Fluids



The user is always responsible for the fluid used. Never use corrosive fluids with this circulator. ▲



Never use 100% glycol. ▲



Handle and dispose of liquids, other than water, in accordance with the fluid manufacturers specification and/or the SDS. ▲



Adjust the circulator's software to the fluid used, see Section 4. ▲



When using water above 80°C closely monitor the fluid level, frequent top-offs will be required. It also creates steam. ▲



Water/glycol mixtures require top-offs with pure water, otherwise the percentage of glycol will increase resulting in high viscosity and poor performance. ▲



Polyphenylene oxide (PPO) Bath Circulators are used with water only. ▲

The fluid information is only a guide since specifications may change.

Thermo Fisher Scientific takes no responsibility for damages caused by the selection of an unapproved bath fluid.

Unapproved bath fluids are fluids which are:

- very highly viscous (much higher than 30 mPas at the respective working temperature)
- have corrosive characteristics or
- tend to break down at high temperatures

For fluid selection consider application requirements, operating temperature range, material compatibility, safety concerns, and environmental issues.

### Chlorine

Short term usage of tap water may not cause any adverse effects on the circulator or your application, but in the long term problems may arise. To help alleviate these problems Thermo Fisher Scientific recommends the use of chlorine.

The duration of time that chlorine remains in solution depends on factors such as water temperature, pH and availability of direct sunlight. We recommend maintaining chlorine levels at proper levels using chlorine test strips, generally 1 to 5 ppm is adequate.

For best results, maintain the pH of the fluid between 6.5 and 7.5. Do not add additional chlorine without first determining the concentration ratio that already exists in the fluid supply. Corrosion and degradation of the circulation components can result from concentration ratios that are too high. Contact our customer support for additional information.

**5°C to 95°C — Distilled Water or Deionized Water** (up to 3 MΩ-cm)

Normal tap water leads to calcareous deposits necessitating frequent circulator decalcification, see table on next page.

Calcium tends to deposit itself on the heating element. The heating capacity is reduced and service life shortened.

**-30°C to 80°C — Water with Glycol**

Below 5°C water has to be mixed with a glycol. The amount of glycol added should cover a temperature range 5°C lower than the operating temperature of the particular application. This prevents the water/glycol from gelling (freezing) near the evaporating coil.

Excess glycol deteriorates the temperature accuracy due to its high viscosity.

**-40°C to 200°C — SIL180:**

SIL180 is suitable for covering nearly the entire range with just one liquid, especially when used with the cooling circulators. See next page for additional information.

Unfortunately SIL180 has a wetting tendency necessitating the occasional cleaning of the bath cover.

**other temperatures:**

Thermo Fisher Scientific offers a range of heat transfer fluids for these temperature control applications.

**SYNTH 60 and SYNTH 260:**

Synthetic thermal liquid with a medium life span (several months) and little smell annoyance. See next page for additional information.

**SIL 100, SIL 180, SIL 300:**

Silicone oil with a very long life span (over 1 year) and negligible smell. See next page for additional information.

Thermo Fisher heat transfer fluids are supplied with an EC Safety Data Sheet.

## Additional Fluid Precautions



Ensure, when selecting the heat transfer fluid, that no toxic gases are generated. Flammable gases can build up over the fluid during usage. ▲



Ensure the over temperature cut-off point is set lower than the fire point for the heat transfer fluid selected. ▲



The highest working temperature as defined by the EN 61010-2-010 must be limited to 25°C below the fire point of the bath fluid. ▲

When working with fluids other than water:

- Do not use any fluid until you have read and understood the label and the Material Safety Data Sheet (SDS).
- Do not blend any fluids.
- Ensure any fluid residue or any other material is thoroughly removed before filling the bath with a different fluid.
- Always wear protective clothing, especially a face shield and gloves.
- Avoid spattering on the circulator's components, always *slowly* add fluid. When adding fluid, point the opening of a container away from yourself.
- Use fume hoods.
- Do not allow any ignition sources in the vicinity.



### Fire point

Flammable thermal liquids can ignite when a specified temperature is surpassed. The bath liquid is limited to a temperature level 25°C below the fire point as defined by the EN 61010-2-010.

### Viscosity

For optimum temperature accuracy, it is important that heat transfer liquids have a low viscosity.

#### Working temperature range

This is the recommended long-term operating range. The maximum viscosity is approximately 5 mPas.

#### Operating temperature range

Long-term operation is recommended only under certain conditions. The viscosity may rise to a maximum of 30 mPas. The pump capacity will not match specifications.

#### Heating-up range

Long-term operation is not recommended, the pump motor's excess temperature protection may switch off the pump.

### Range of Application

	Sil 100	Sil 180	Sil 300	Synth 60	Synth 260
Fire Point °C	>100	>225	>325	70	275
Flash Point °C	57	170	300	59	260
Viscosity at 20°C (mPas)	3	11	200	2	140
Density at 20°C (kg/dm <sup>3</sup> )	0.89	0.93	1.08	0.76	1.03
Specific heat capacity (kJ/Kg*K)	1.67	1.51	1.56	2.10	2.00

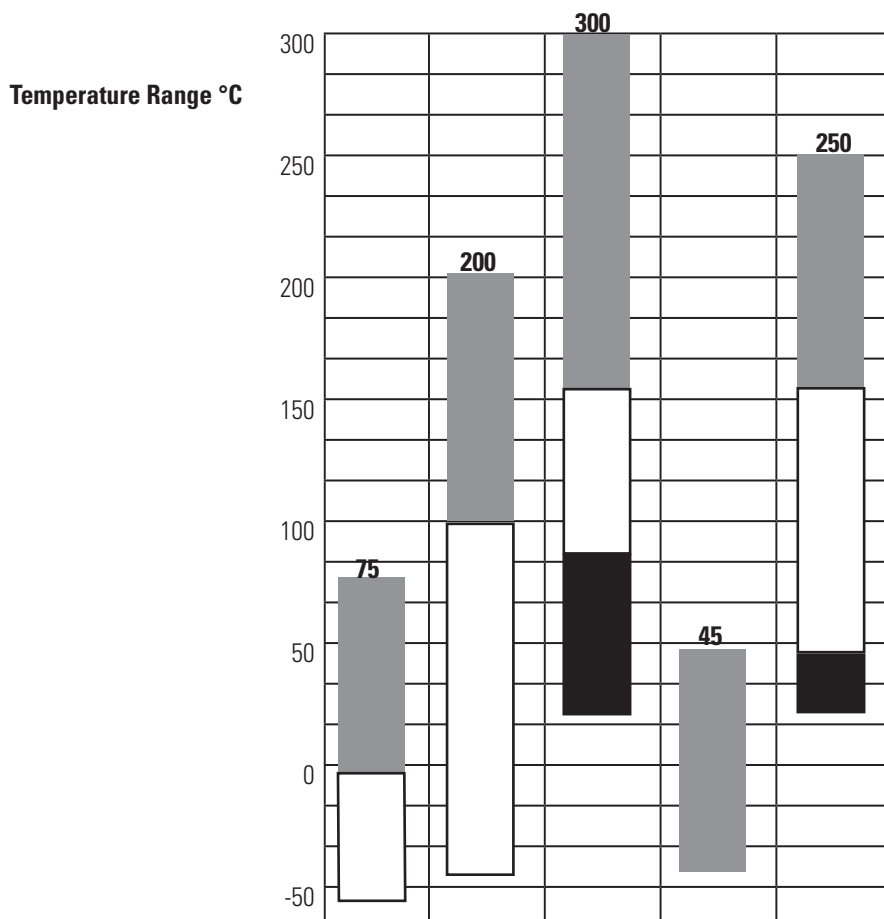

Order Number 10 liter container	999-0202	999-0204	999-0206	999-0210	999-0214
Order Number 5 liter container	999-0201	999-0203	999-0205	999-0209	999-0213
Color	trans-parent, colorless	trans-parent, colorless	trans-parent, colorless	trans-parent, colorless	trans-parent, yellow
Reacts with	Silicone	Silicone	Silicone	Rubber Silicone	Copper Light metals Bronze

EC-Safety Data Sheet will be delivered together with each container of liquid.

## Water Quality and Standards

Process Fluid	Permissible (PPM)	Desirable (PPM)
<b>Microbiologicals</b>		
(algae, bacteria, fungi)	0	0
<b>Inorganic Chemicals</b>		
Calcium	<25	<0.6
Chloride	<25	<10
Copper	<1.3	<1.0
	0.020 ppm if fluid in contact with aluminum	
Iron	<0.3	<0.1
Lead	<0.015	0
Magnesium	<12	<0.1
Manganese	<0.05	<0.03
Nitrates/Nitrites	<10 as N	0
Potassium	<20	<0.3
Silicate	<25	<1.0
Sodium	<20	<0.3
Sulfate	<25	<1
Hardness	<17	<0.05
Total Dissolved Solids	<50	<10
<b>Other Parameters</b>		
pH	6.5-8.5	7-8
Resistivity	0.01*	0.05-0.1*

\* M $\Omega$ -cm (compensated to 25°C)

Unfavorably high total ionized solids (TIS) can accelerate the rate of galvanic corrosion. These contaminants can function as electrolytes which increase the potential for galvanic cell corrosion and lead to localized corrosion such as pitting. Eventually, the pitting will become so extensive that refrigerant will leak into the water reservoir.

As an example, raw water in the United States averages 171 ppm (of NaCl). The recommended level for use in a water system is between 0.5 to 5.0 ppm (of NaCl).

Recommendation: Initially fill the tank with distilled or deionized water. Do not use untreated tap water as the total ionized solids level may be too high. This will reduce the electrolytic potential of the water and prevent or reduce the galvanic corrosion observed.

## Filling Requirements

Ensure the reservoir drain port on the front of the bath is *closed* and that all plumbing connections are secure. Also ensure any residue is thoroughly removed before filling the bath.



**Before using any fluid refer to the manufacturer's SDS and EC Safety Data Sheet for handling precautions. ▲**

To avoid spilling, place your containers into the bath before filling.

With a low level WARNING the circulator continues to run, with a FAULT the circulator shuts down the refrigeration, pump and heater, see Section 7. The low level warning is at approximately 43 mm (1 3/4") below the top, the low level fault is at approximately 57 mm (2 1/4").



**Oil-based fluids expand when heated. Fill the reservoir only to the minimum level. Monitor the fluid level whenever heating the fluid. ▲**

When pumping to an external system, keep extra fluid on hand to maintain the proper level in the circulating lines and the external system.

## Draining



**Before draining any fluid refer to the manufacturer's SDS and EC Safety Data Sheet for handling precautions. ▲**



**Ensure the fluid is at a safe handling temperature, ~40°C. Wear protective clothing and gloves. ▲**

- place a suitable vessel underneath the drain. If desired, attach an 8 mm id tube on the drain.
- *slowly* turn the drain plug until flow is observed.



**Turning the drain cap more than 1 1/2 turns will result in the drain cap and fitting coming off the bath. ▲**

In this case screw the drain fitting back into the bath. Attaching the cap onto the fitting aids in installation. If required, contact us for additional information.

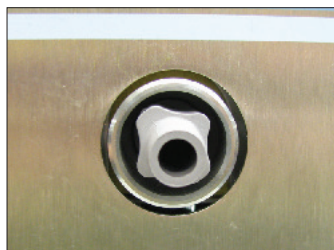

Installed Drain Fitting with Cap Removed



## Section 4 Operation

### ADVANCED Heated Immersion Circulator

The Thermo Scientific ADVANCED Series of Heated Immersion Circulators have a digital display and easy-to-use touch pad, five programmable setpoint temperatures, acoustic and optical alarms. All circulators offer adjustable high temperature protection.

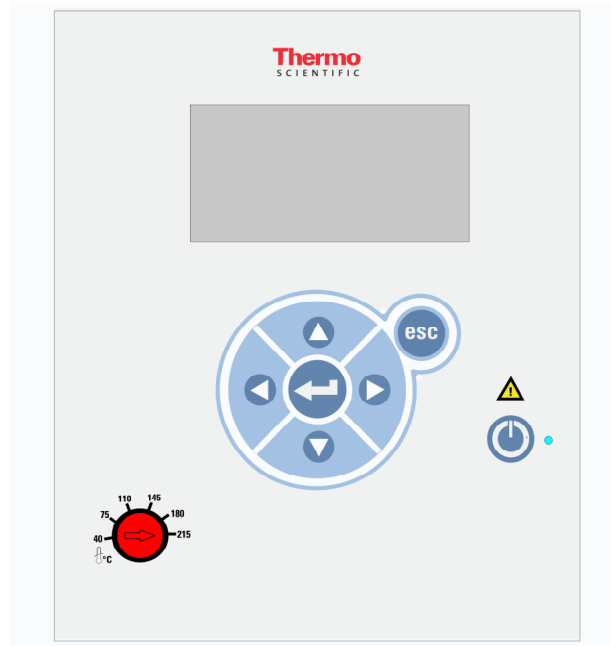

This label indicates read the instruction manual before starting the circulator.



Use this button to place the circulator in and out of standby, see page 4-3 for more details. The blue LED illuminates when standby is enabled.



Use these navigation arrows to move through the circulator displays and to adjust values.



Pressing this button once to make changes on the immersion circulator's display screen. In most cases, pressing it again is required to save the change.



Use this button to cancel any changes and to return the immersion circulator to its previous display. Canceling a change can only be made before the change is saved. In some cases, it is also used to save changes.

**Note** Holding this button for five seconds resets the display contrast to the default level and also brings up the language menu to change, if needed, the displayed language. See **Settings-Display Options** in this Section. ▲

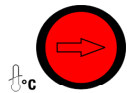

Used for adjusting and resetting the High Temperature Cutout. Details are explained in this Section.

## Setup



Leave refrigerated baths in an upright position at room temperature (~25°C) for 24 hours before starting. This will ensure the lubrication oil has drained back into the compressor. ▲



Before starting, double check all USB (optional), electrical and plumbing connections. ▲

## Start Up

Ensure the HTC is in the full clockwise position.

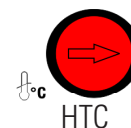

Do not run the circulator until fluid is added to the reservoir. Have extra fluid on hand. If the circulator does not start refer to Section 5 Troubleshooting.

- On refrigerated baths, place the circuit protector located on the rear to the **I** position.
- Place the circuit protector located on the back of the immersion circulator to the **I** position.



After a slight delay the blue LED on the front panel illuminates.

- Press , the Start Display appears and the blue LED goes out.
- Ensure the start symbol has a highlight box around it, if not use the arrow keys to navigate to the symbol.

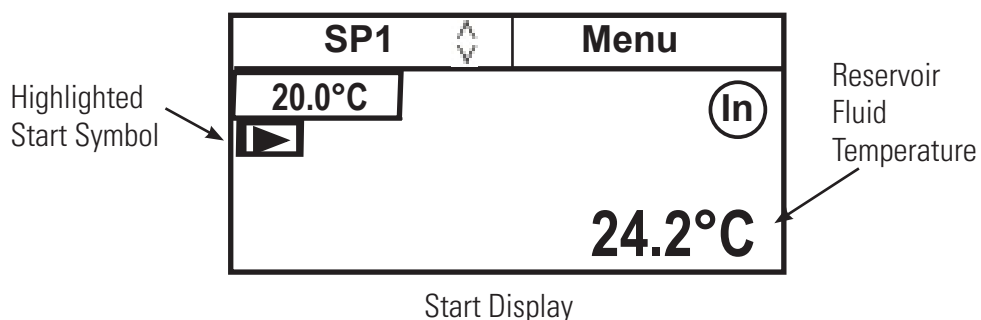

- Press . The circulator starts and the start symbol turns into a stop symbol (a solid black square).



**Note** The pump starts immediately but refrigerated baths take up to 30 seconds before the compressor starts. ▲

**Note** After start up, check all the plumbing connections for leaks. ▲



The **SP1** and **Menu** portions on the top of the display are used to view and/or change the circulator's settings. They are explained in detail later in this Section.

**In** indicates the circulator is using its internal sensor for temperature control. **Ex** indicates the circulator is using an external sensor for temperature control.

## Status Display

If desired, press  to toggle between the Start/Status Displays.

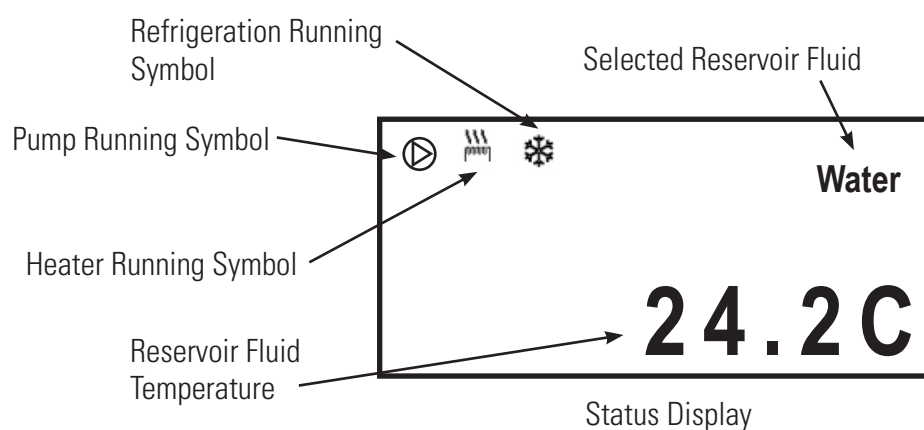



**Note** If no operator inputs are being made, the circulator automatically switches to the Status Display after 60 seconds. If desired, change the time or disable this feature using the **Display Options** Menu. ▲

## Stand By Mode

Press , the display goes blank and the circulator enters the stand by mode. The blue LED illuminates.

## Stopping the Circulator

Ensure the stop symbol is highlighted, if not use the arrow keys to navigate to the symbol.

Press . The circulator stops and the stop symbol turns into a start symbol ().

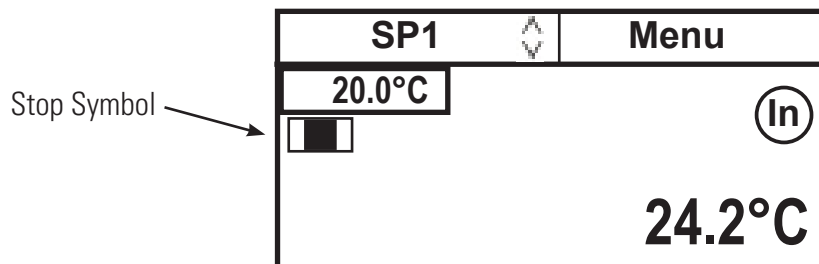

## Power Down

Press , the display goes blank and the circulator enters the stand by mode. The blue LED illuminates.

## Shut Down

Place the circuit protector on the back of the circulator to the  position. The blue LED extinguishes.



On refrigerated baths, place the circuit protector on the rear of the bath to the  position.



Using any other means to shut down a refrigerated bath can reduce the life of the compressor. ▲



Always turn the circulator off and disconnect it from its supply voltage before moving it. ▲



The circuit protector located on the rear of the components is not intended to act as a disconnecting means. ▲

## Restarting

**Note** When quickly restarting, the compressor may take up to 10 minutes before it starts to operate. ▲

## Changing the Setpoint

**Note** You can not adjust the setpoint closer than 0.1°C to either of the fluid's system limits, see Fluids Type in this Section, or beyond the circulator's temperature range. ▲

The setpoint can be changed with the circulator running or not.

The Setpoint is the desired process fluid temperature. The circulator can store up to five setpoints, **SP1** through **SP5**. The procedure for changing stored setpoint values is discussed later in this Section.

Use the navigation arrows and move to the setpoint window and then press  to highlight it and the setpoint value as shown below.

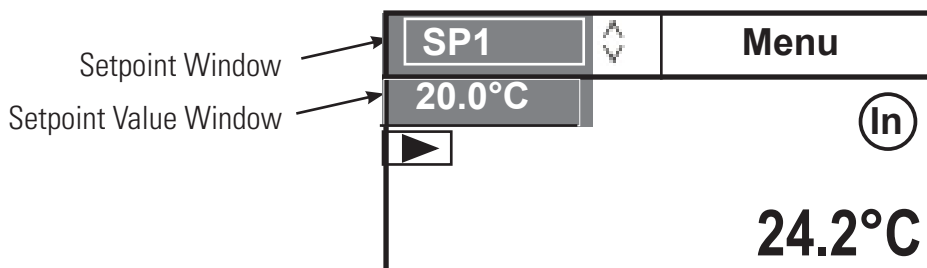

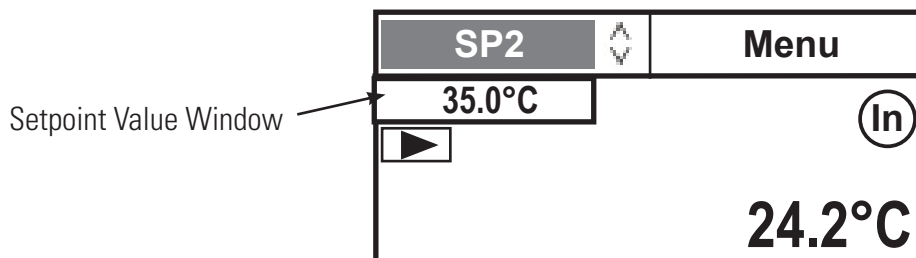

Use the up and down navigation arrows to bring up the desired setpoint, **SP1** through **SP5**, and then press .

The Setpoint Value Window now indicates the corresponding setpoint's stored value.

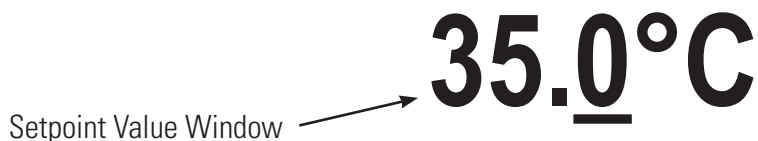

If desired, you can change the displayed setpoint value by using the navigation arrows to highlight the Setpoint Value Window and then pressing . The right-most digit will have a cursor beneath it.



Use the left and right arrows to move the cursor to the desired digit and then use the up and down arrows to change the value. Once all the desired changes are made, press  to save the change.

**Note** Using this procedure also changes the setpoint's stored value. ▲

## Menu Displays

The circulator uses menus to view/change the settings.

**Note** The circulator does not need to be running to view/change these settings. ▲

For all **Menu** displays, once  is pressed to change a display, you can press  to return to the previous screen.

1. Use the arrow buttons to highlight **Menu** and the circulator brings up the Main Menu Display.

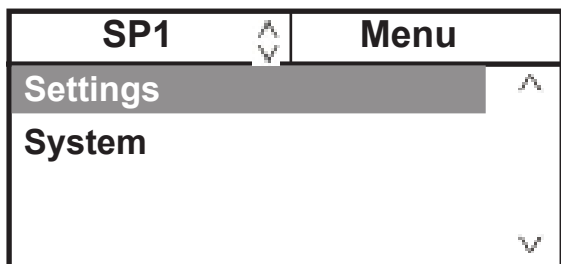

Main Menu Display

2. Use the up and down arrow to highlight the desired setting and then press  to bring up additional submenus.

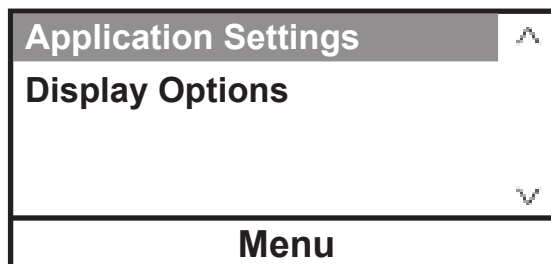

See page 4-8.

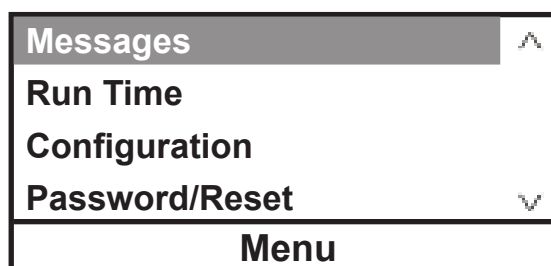
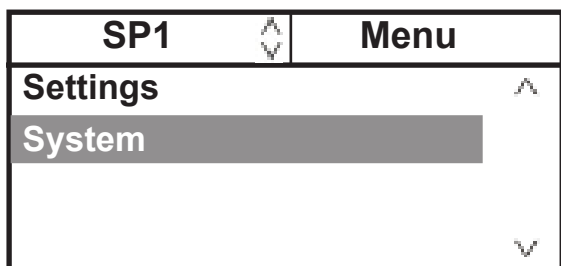

See page 4-17.

## Menu

The **Menu** line, at the bottom of all the submenu displays, is another way to return the circulator back to the Start Display.

1. From any submenu display, use the down arrow button to highlight **Menu**.

2. Press  to return to the Start Display.

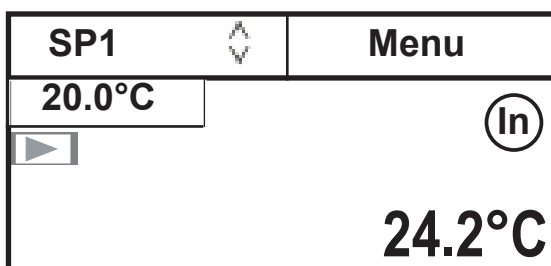
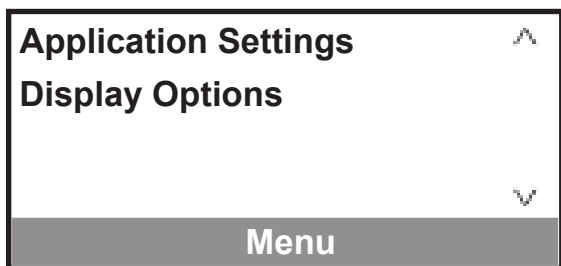

Start Display

Pressing  from the Menu line returns you to the previous screen.

# Menu Tree

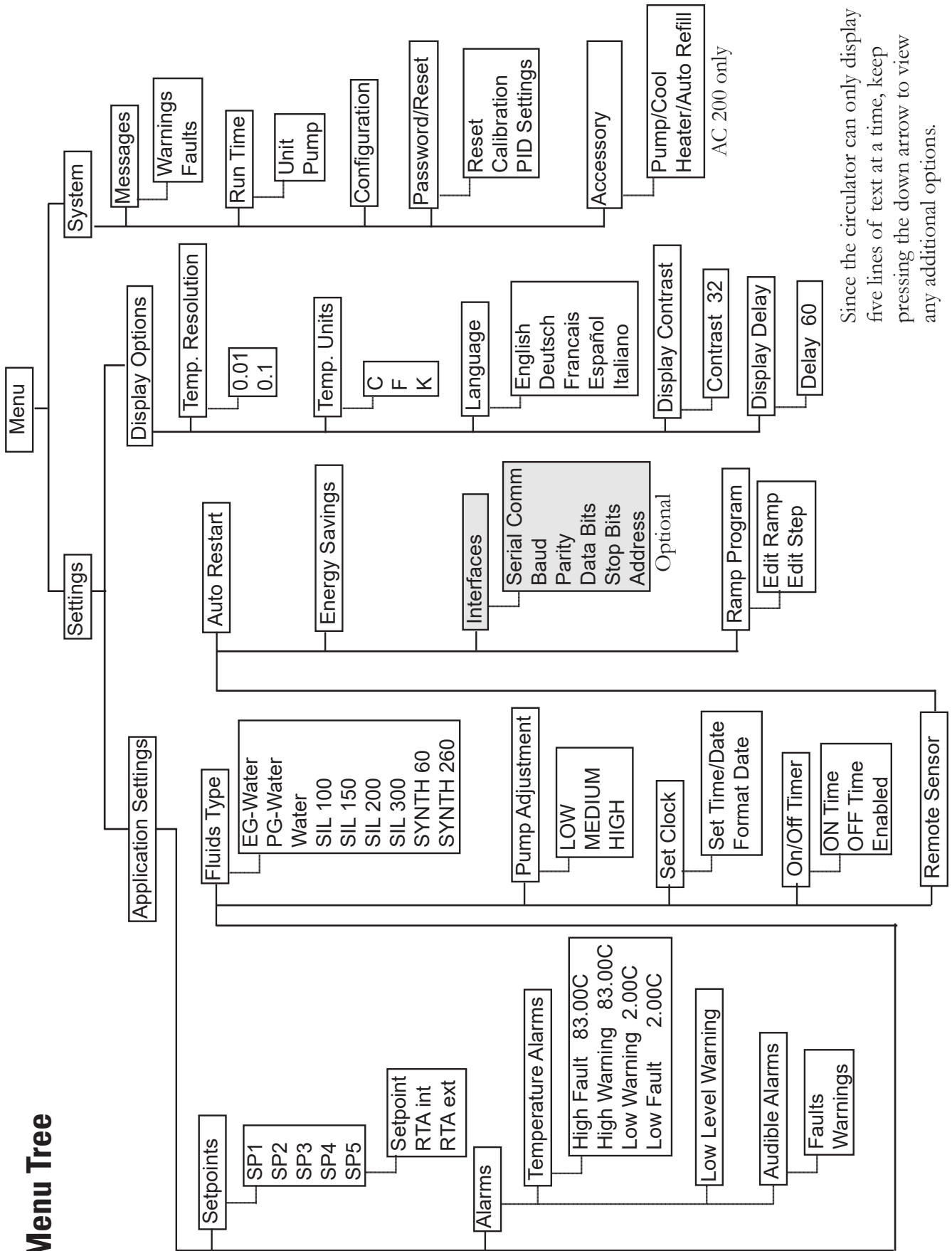

Since the circulator can only display five lines of text at a time, keep pressing the down arrow to view any additional options.

**Settings - Application Settings** is used to view/adjust the circulator's five Setpoints (**SP**) and Real Temperature Adjustments (**RTA**), enable/disable the alarms, change the fluid type, set the pump speed, configure the interface (optional), set the clock, turn the timer on or off, and turn auto restart and energy savings on or off.

1. With **Application Settings** highlighted press  to view:

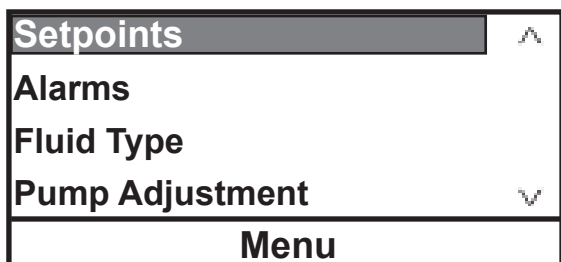

2. Scroll down for additional options.

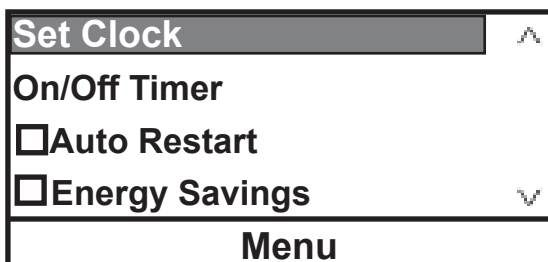

3. With **Setpoints** highlighted, press  to display the list. Use the up/down arrows to highlight the desired **SP**. (Use the down arrow to display **SP5**.)

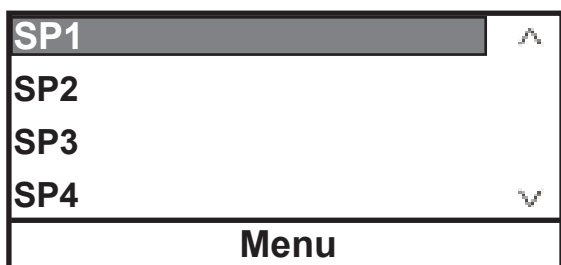

4. Press .

The Setpoint and RTA are changed using the same procedure. With the desired setpoint highlighted press  to display the submenu.





If this temperature on the Start/Status Displays does not accurately reflect the actual temperature in the reservoir, an RTA can be applied. The RTA can be set  $\pm 10^{\circ}\text{C}$  ( $\pm 18^{\circ}\text{F}$ ).

As an example, if the circulator's temperature is stabilized and displaying  $20^{\circ}\text{C}$  but a calibrated reference thermometer reads  $20.5^{\circ}\text{C}$ , set the RTA to  $-0.5^{\circ}\text{C}$ . After you enter a RTA value allow the temperature to stabilize before verifying the temperature in the bath. **Note** If display accuracy is required, we recommend repeating this procedure at various setpoint temperatures and on a regular basis. ▲

**Note** You cannot adjust the setpoint closer than  $0.1^{\circ}\text{C}$  to either of the fluid's system limits, see Fluids Type in this Section. ▲

5. With the desired line highlighted press .

The right-most digit will have a cursor beneath it. Use the left and right arrows to move the cursor to the desired digit and then use the up and down arrows to change the value. Once all the desired changes are made, press  to save the change or  to cancel it.

**35.0°C**

**Alarms** is used to view/adjust the high and low temperature alarm limits, to enable/disable the audible alarms and to configure the low level warning reaction. **Note** The alarm range limits depend on the fluid, circulator and bath used, see next page. ▲

1. With **Alarms** highlighted, press  to display:

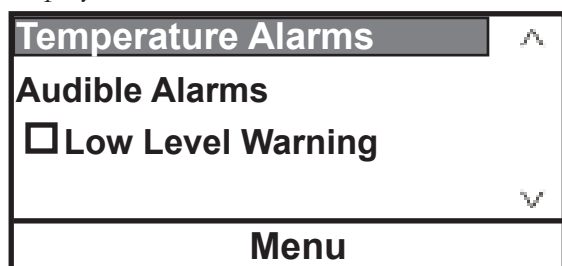

2. With **Temperature Alarms** highlighted, press  to display:

High Fault	83.0°C	▲
High Warn	83.0°C	
Low Warn	2.0°C	
Low Fault	2.0°C	▼
Menu		

3. Highlight the desired limit and press . Follow the same procedure used to change a setpoint.

If the **Fault** temperature is exceeded the circulator shuts down and, if enabled, the audible alarm sounds. If the **Warn** temperature is exceeded the circulator continues to run and, if enabled, the audible alarm sounds. In either case a message is displayed.

**High Fault** cannot be set below **High Warn**.

**High Warn** cannot be set below **Low Warn**.

**Low Fault** cannot be set above **High Warn**.

**Note** When changing the temperature alarms the current setpoint also changes if it falls outside the new limits. ▲

1. With **Audible Alarms** highlighted, press  to display the alarms. The factory presets are off.

Highlight the desired alarm and press  to toggle between enable and disable mode.

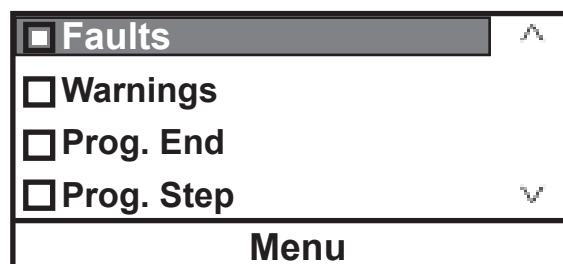

If **Faults** is enabled the alarm sounds when a fault occurs. If **Warnings** is enabled the alarm sounds when a warning occurs.

If **Prog. End** is enabled the circulator beeps twice at the end of each cycle and three times at the end of the program. If **Prog. Step** is enabled the circulator beeps once at the beginning of the program and once at the end of each step. Press  to return to the previous display.

1. With **Low Level** highlighted, press  to toggle the low level warning alarm on/off.

The factory preset is off.

Press  to return to the previous display.

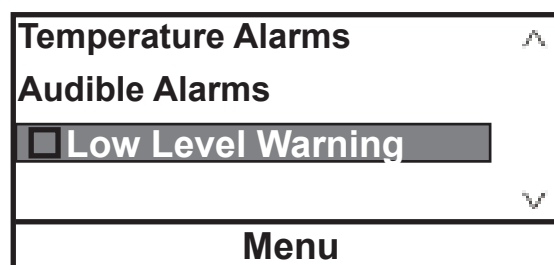

**Note** The low level cutout is always enabled and if activated will generate a fault message. ▲



**Fluids Type** is used to identify the type of fluid used. The circulator uses the fluid type to automatically set certain operating parameters.



**Polyphenylene oxide (PPO) Bath Circulators are used with water only. ▲**

1. With **Fluid Type** highlighted, press to display the list of approved fluids.

Highlight the desired fluid and then press to select it.

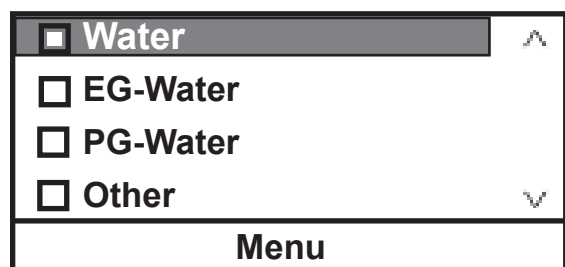

2. With the desired fluid selected press to return to the previous display.

**Note** The circulator's operating range is determined by the currently selected fluid. When a new fluid is selected the circulator, if necessary, automatically adjusts the temperature alarms and/or setpoint. ▲

**Pump Adjustment** is used to review/set the desired pump speed.

1. With **Pump Adjustment** highlighted, press to display the speeds.

Highlight the desired speed and press to select it.

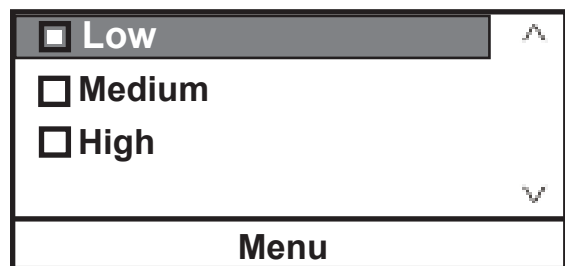

**Fluid temperature alarm limits**  
High °C      Low °C

**AC150 circulators:**

Water	+95	+5
Ethylene Glycol-Water	+100	-30
Propylene Glycol-Water	+100	-20
Other	+150	-40
SIL 100	+75	-40
SIL 180	+150	-40
SIL 200	+150	+20
SIL 300	+150	+80
SYNTH 60	+45	-40
SYNTH 260	+150	+45

**AC200 circulators:**

Water	+95	+5
Ethylene Glycol-Water	+100	-30
Propylene Glycol-Water	+100	-20
Other	+200	-40
SIL 100	+75	-40
SIL 180	+200	-40
SIL 200	+200	20
SIL 300	+200	+80
SYNTH 60	+45	-40
SYNTH 260	+200	+45

**Note** The range is also limited by the bath temperature range, see Section 2. ▲

**Note** When using oil as a reservoir fluid, we recommend running the circulator at 95°C for 15 minutes to remove any moisture in the fluid. ▲

**Set Clock** is used to set the circulator's **Set Time/Date** (hr : min : sec) and date (year - month - day).

**Format Date** is only applied to the date sent out the serial interface **DD/MM/YYYY** or **MM/DD/YYYY**. The date displayed is fixed at year - month - day.

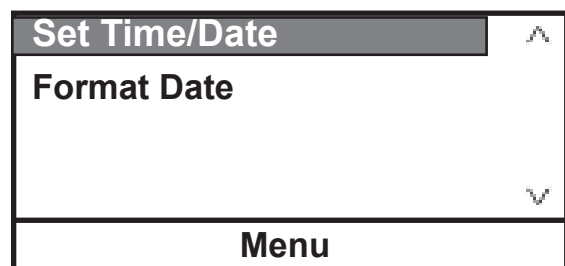

**On/Off Timer** is used to enable and set the circulator's timer.

1. With **On/Off Timer** highlighted, press  to display the on ( I ) and off ( O ) time as well as the enable box.

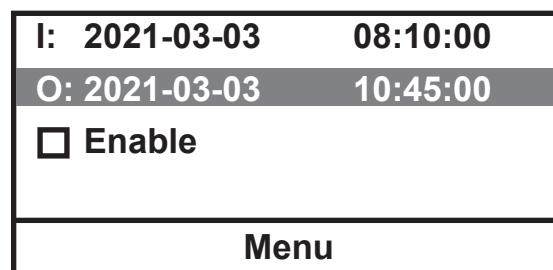

After setting the on and off times highlight **Enable** and press  to activate the timer.

**Remote Sensor** is used to enable the optional remote temperature sensor feature, see Section 3.

1. With optional **Remote Sensor** highlighted, press  to toggle between enable and disable.

**Auto Restart** is used to enable the auto restart feature. When enabled, the immersion circulator automatically restarts after a power failure or power interruption condition is restored. If a ramp was running when power failed, the ramp program resumes where it left off. **Note** Consider any possible risks before enabling this mode of operation. ▲

1. With **Auto Restart** highlighted, press  to toggle between enable and disable.

**Energy Saving** is used to enable the energy savings mode. The Energy Saving mode is primarily designed for applications running under a stable load. Enabling the mode saves energy by reducing the circulator's heater power and cooling requirements. This can result in substantial energy savings over the life of the circulator. The default setting is disable (enable for A45HC refrigerated circulators).

1. With **Energy Saving** highlighted, press  to toggle between enable and disable.

## Edit - Ramp Program (AC 200 only)

**Edit Ramp Program** is used to view/adjust the immersion circulator's program function.

Define your program as a series of setpoints with a known period of time interval between each. Each interval is one step of the program. Pay careful attention to the first part of your program. What conditions must exist at the beginning of your process? For example, at the starting setpoint you may need to program an initial period of constant temperature to allow for thermal stabilization.

**Note** Consider the circulator's limitations when designing programs. Temperature or time parameters which exceed the performance capabilities of the circulator will result in unsatisfactory operation. If reaching the ramp setpoint temperatures is important, you will have to operate the bath between the desired setpoints and note the duration before programming the ramp. ▲

It is possible to create a program calling for very rapid changes in temperature. Although the circulator may not be capable of producing such changes, it may be practical to program such steps as a way to cause the fastest possible temperature change.

The ramp program has an **Assured Soak** feature that can be enabled for each step independently. When enabled this feature pauses the ramp timer until the temperature reaches setpoint,  $\pm$  variance. This assures the temperature reaches setpoint before the ramp program continues to the next step.

1. With **Ramp Program** highlighted press  to display:

<b>Edit Ramp</b>	▲
<b>Edit Step</b>	
	▼
<b>Menu</b>	

2. With **Edit Ramp** highlighted press  to display:

<b>No of Steps</b>	<b>xx</b>	▲
<b>Variance</b>	<b>xxx.xx</b>	
<b>Cycles</b>	<b>xxx</b>	
<b>End State</b>	<b>Shut Down</b>	▼
<b>Menu</b>		

The ramp can have up to 30 **Steps**.

The **Variance** is used to set a temperature range, the program starts when the fluid temperature is within this range. For example, if the desired **Start Temp** is 25°C and the **Variance** is set to +5°C, the program automatically starts when the bath temperature is between 20°C to 30°C.

**Cycles** sets the number of times the entire ramp program is repeated after the last step is completed. For example, selecting 3 **Cycles** runs the entire ramp program a total of 3 times.

**End State** configures the circulator to either **Shut Down** or continue running (**Maintain**) when the program is over.

3. Once the **Edit Ramp** portion is complete press **esc** and then highlight **Edit Step**.

<b>Edit Ramp</b>	^
<b>Edit Step</b>	
	v
<b>Menu</b>	

4. Use **Edit Step** to enter the parameters for each step. The maximum **Duration** for a step is 1000 minutes.

<b>Step #</b>	<b>XX</b>	^
<b>Start Temp</b>	<b>xxx.xx</b>	
<b>Stop Temp</b>	<b>xxx.xx</b>	
<b>Duration (min)</b>	<b>xxxxx</b>	v
<b>Menu</b>		

Other than step one, by default the circulator automatically sets the **Start Temp** with the **Stop Temp** from the previous step. This value cannot be changed.

5. Scroll down to view the **Assured Soak** feature. Press **←** to enable/disable.

<b>Start Temp</b>	<b>xxx.xx</b>	^
<b>Stop Temp</b>	<b>xxx.xx</b>	
<b>Duration (min)</b>	<b>xxxxx</b>	
<input type="checkbox"/> <b>Assured Soak</b>		v
<b>Menu</b>		

6. After all the desired steps are built, keep pressing **esc** until the Start Display appears.





<b>SP1</b>	Menu
<b>20.00°C</b>	(In)
	<b>24.29 °C</b>

You can enable an alarm to sound when each step and/or the program is complete, see **Settings - Basic Settings** in this section.

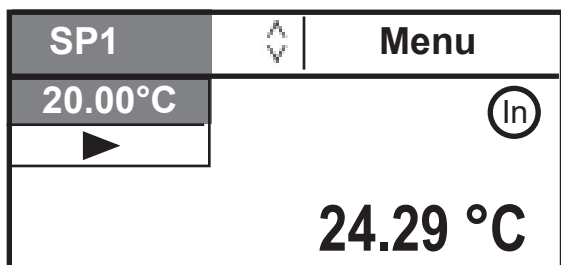
## Running a Ramp Program

1. Use the arrow keys to highlight **SP** window and press .



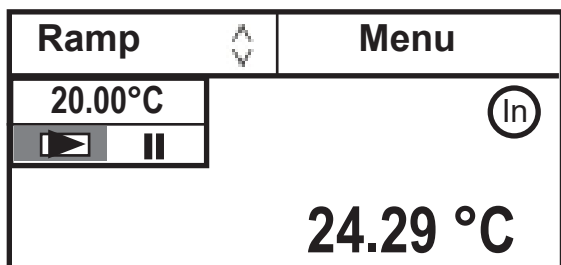

3. Press  and the circulator displays the start  and pause/resume  program symbols. Highlight the start symbol .



 Start program

 Stop program and shut down circulator



 Pause program, press  to restart



Current Cycle: Current Step:  
Total Program Time Remaining (Minutes)

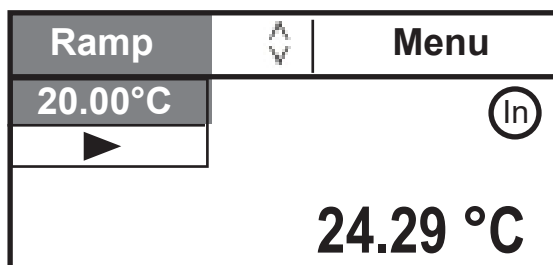

2. Press the up or down arrow until the window displays **Ramp**.



4. With the start symbol highlighted, press  to start the program. The start symbol changes into a highlighted stop program symbol .

**Note** With the stop symbol  highlighted, pressing  shuts down the circulator. ▲

The program does not start until the process fluid temperature is at the **Step 1 Start Temp** ± the **Variance**.

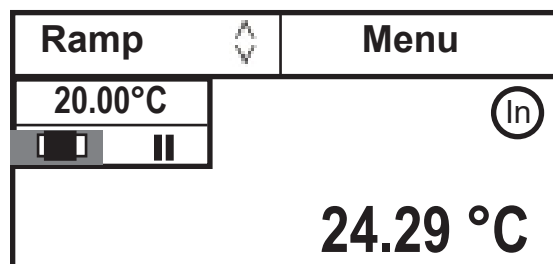

Switching to the Status Display while a ramp program is running shows the status and program time remaining. **Note** If assured soak is enabled the time stops counting down at the end of the step until the desired temperature ± variance is reached. ▲

If a program is not running, highlighting **Ramp** with the circulator running causes the bath temperature to go to the ramp **Start Temp**. The temperature remains there until the ramp is started.

5. To pause the program at the current temperature, highlight the pause program symbol **||** and press .

To restart the program press  again.

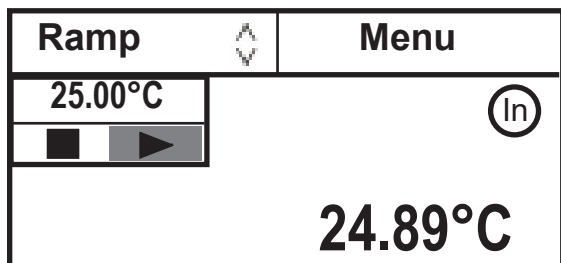

6. When the program is complete the circulator either **Shuts Down** or **Maintains** the last setpoint.

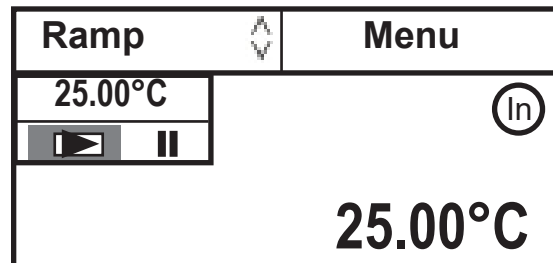

When  is pressed after the ramp program is complete the refrigeration, pump and circulator shut off.

**Interfaces** is used to enable/configure the optional serial communications feature.

1. With **Interfaces** highlighted, press  to display the list of parameters.

Highlight the desired parameter and press  to view/change the available options.

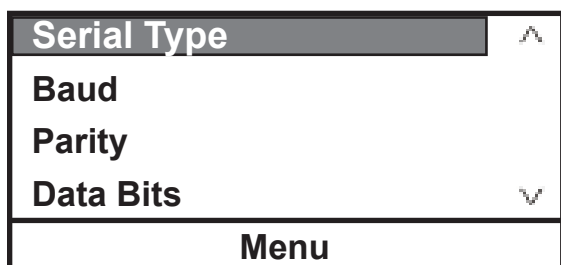

#### Available options:

**Serial Type** Off, RS232, RS485 or Analog IO

**Baud** 38400, 19200, 9600, 4800, 2400, 1200, 600 or 300

**Parity** None, Odd or Even

**Data Bits** 8 only

**Stop Bits** 1 or 2

**Address** (Displayed for RS485 only)

Supported protocols: AC, Standard, NC, Namur

See the Appendix for additional information.

**Note** Keypad operation is still available with serial communications enabled. ▲

**Settings - Display Options** is used to view/adjust the circulator's Temperature Units, the Temperature Resolution, the displayed Language, the Display Contrast and the Display Delay.

1. With **Temp. Unit** highlighted press . Use the up/down arrows to highlight the desired temperature scale.

Press .

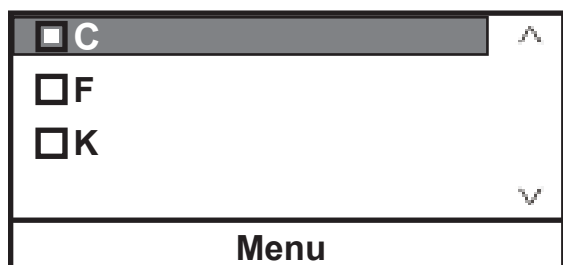

2. With **Temp. Resolution** highlighted press .

Use the up/down arrows to highlight the desired resolution. Press .

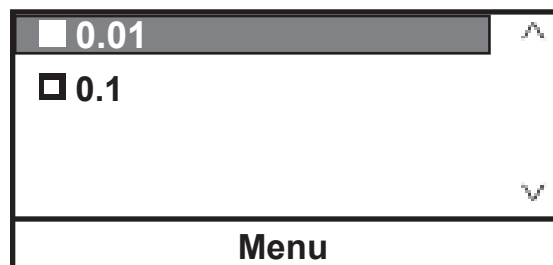

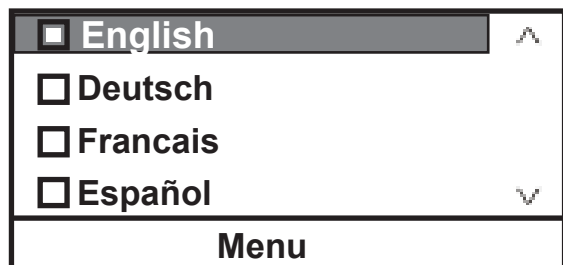

3. With **Language** highlighted press . Use the up/down arrows to highlight the desired language. (Scroll down for additional languages.)

Press .



4. With **Display Contrast** highlighted press .

Press  again and use the up/down arrows keys to change the contrast. With the desired contrast showing, press  again.

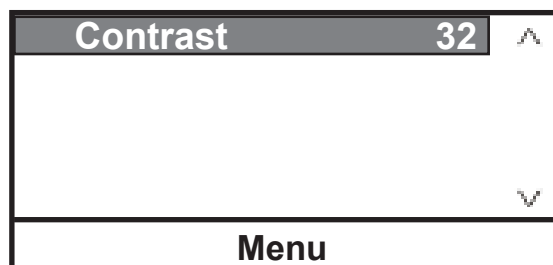

**Note** Holding  for five seconds resets the display contrast to the default level and also brings up the language menu to change, if needed, the displayed language. ▲

5. With **Display Delay** highlighted press  to enable/disable it.

Use the up/down arrows to highlight the time and press  again.

Use the up/down arrows to change the value. Once the desired delay is displayed press .

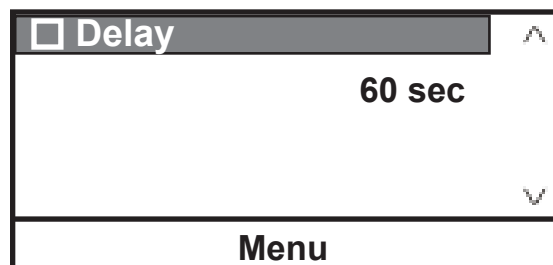

With **Display Delay** enabled and the Start Display showing, if no arrows are pressed the Start Display changes to the Status Display after the delay expires, see pages 4-2 and 4-3.



**System Messages** is used to view any Warning or Fault messages.

1. With **Messages** highlighted, press  to display the options.

<b>Warnings</b>	^
<b>Faults</b>	
	v
<b>Menu</b>	

**System Run Time** is used to view the circulator (**Unit**) and pump operating hours.

1. With **Run Time** highlighted, press  to display the times.

<b>Unit</b>	<b>xxx hours</b>	^
<b>Pump</b>	<b>xxx hours</b>	
		v
<b>Menu</b>		

**System Configuration** is used to view the circulator's configuration.

1. With **Configuration** highlighted, press  to display the settings.

<b>Head</b>	<b>AC200</b>
<b>FW</b>	<b>XXXXXXXX.XX</b>
<b>Checksum</b>	<b>XXXX</b>
<b>Bath</b>	<b>A10; 115V</b>
<b>FW</b>	<b>XXXXXXXX.XX</b>
<b>Menu</b>	

Without a bath connected the display is:

<b>Head</b>	<b>AC200</b>
<b>FW</b>	<b>XXXXXXXX.XX</b>
<b>Checksum</b>	<b>XXXX</b>
<b>Bath</b>	<b>None</b>
<b>FW</b>	<b>XXXXXXXX.XX</b>
<b>Menu</b>	

With an invalid bath connected the display is:

<b>Head</b>	<b>AC200</b>
<b>FW</b>	<b>XXXXXXXX.XX</b>
<b>Checksum</b>	<b>XXXX</b>
<b>Bath</b>	<b>Invd xx</b>
<b>FW</b>	<b>XXXXXXXX.XX</b>
<b>Menu</b>	

**System - Password/Reset** is used only by a qualified technician. Changing the password enables circulator reset options, the temperature sensor calibration procedure and displays PID values.

1. With **Password/Reset** highlighted, press  to display:

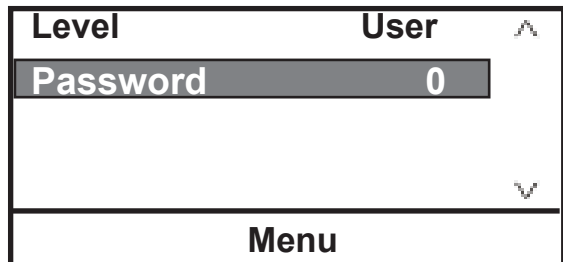

2. Press  and change the number to **1**.

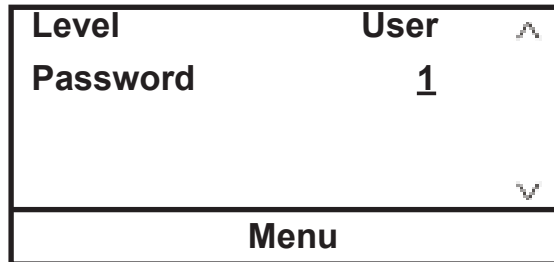

3. Press  to display:

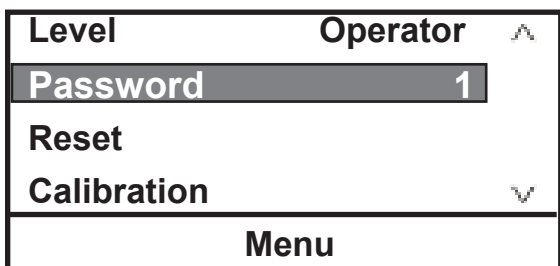

4. If desired, highlight **Reset** and press  to display:

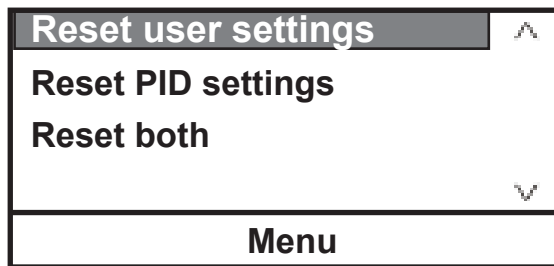

**Note** The circulator resets to the **User** mode when it is turned off. The circulator also resets to the **User** mode when the Start/Status Display is displayed continuously for 10 minutes. ▲

Highlight the desired reset option and press .

A confirmation message will appear, press .

The circulator will enter the stand by mode.

5. With **Calibration** highlighted, press  to calibrate the internal temperature sensor. The procedure is covered on the next page.

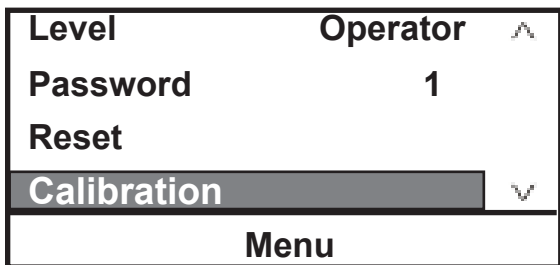

6. Scroll down to display **PID Tuning**, see page 4-20.

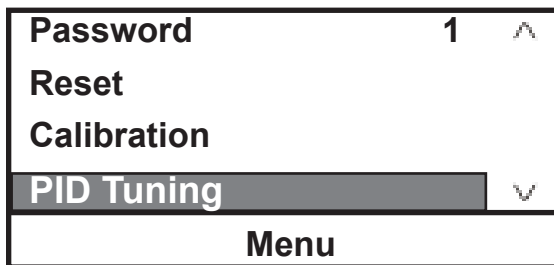

**Note** Ensure the RTA is set to 0 before doing a calibration. ▲

1. To calibrate the temperature sensor highlight **Calibration** and press  to display:

Internal RTD	▲
External RTD	
	▼
Menu	

2. With the desired sensor highlighted, press  to display:

Calibrate	▲
Restore User Cal	
Save User Cal	
Restore Factory Cal	▼
Menu	

3. Press  to display:

Internal RTD	xx.x	▲
High	xx.x	
Low	xx.x	
Calibrate	SP	xx.x ▼
Menu		

4. Highlight the **SP** temperature box and enter either the desired high end or low end setpoint value and press .

Internal RTD	xx.x	▲
High	xx.x	
Low	xx.x	
Calibrate	SP	xx.x ▼
Menu		

5. Depending on which end you are calibrating highlight **High** or **Low**. Once the **Internal RTD** temperature stabilizes for several minutes enter the temperature displayed on your reference thermometer and press .

6. Highlight **Calibrate** and then press  to complete the high end procedure.

Internal RTD	xx.x	▲
High	xx.x	
Low	xx.x	
Calibrate	SP	xx.x ▼
Menu		

Internal RTD	xx.x	▲
High	xx.x	
Low	xx.x	
Calibrate	SP	xx.x ▼
Menu		

7. Repeat for the low end setpoint.

Internal RTD	xx.x	▲
High	xx.x	
Low	xx.x	
Calibrate	SP	xx.x ▼
Menu		

Once complete you can store the calibration into memory by selecting **Save User Cal** and pressing .

You can later restore the same calibration by highlighting **Restore User Cal** and pressing .

Another option is to restore the factory calibration values by highlighting **Restore Factory Cal** and pressing .

1. With **PID Tuning** highlighted, press  to display:

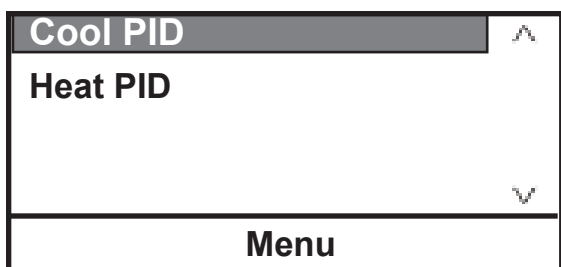

2. Highlight the desired PID and press  to display:

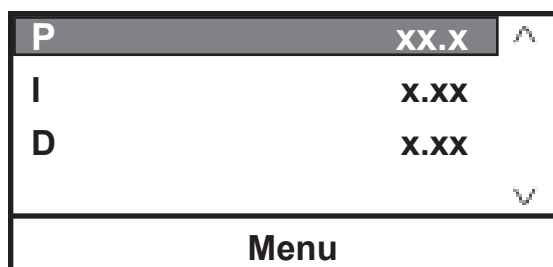

3. If required, press  to change the value.

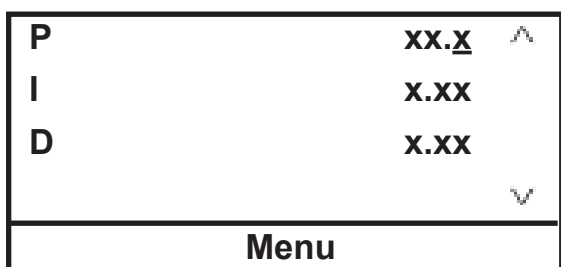

Factory preset values are:

P = 00.6

I = 0.60

D = 0.00

**System - Accessory (AC200 only) Boost Heater** (pins 5 and 10) is on when enabled and the setpoint is  $>2^{\circ}\text{C}$  above the bath temperature. Boost heater is normally off when the bath temperature is within  $2^{\circ}\text{C}$  of setpoint.

**Boost Pump** (pins 4 and 14) is on whenever the option is enabled.

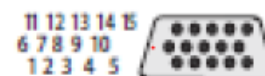

Multifunction Port in Out

The **Solenoid Valve** and **Auto Refill** are used in conjunction with an *optional* accessory box to select and activate additional features. The box connects to the multifunction port on the rear of the immersion circulator. **Solenoid Valve** for cooling coils (pins 4 and 14) is on when the bath temperature is  $>2^{\circ}\text{C}$  above setpoint or when the heater power drops to 0%. The solenoid is off when the heater power exceeds 80%. **Auto Refill** (pins 5 and 10) is on when the fluid level drops below 47 mm ( $\sim 1\ 7/8$ " ) from the top and is off when the fluid level is at 27 mm ( $\sim 1$ " ) from the top.

1. With **Accessory** highlighted, press  to display:

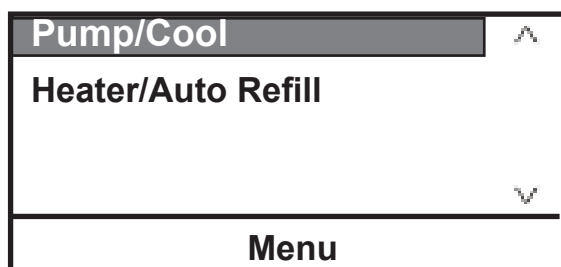

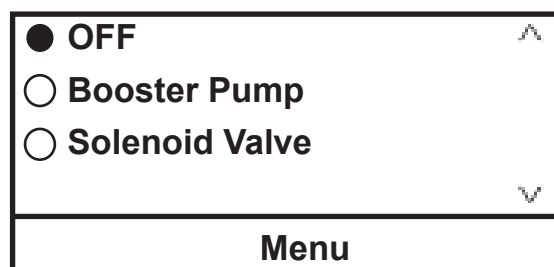

2. With **Pump/Cool** highlighted press  to display:

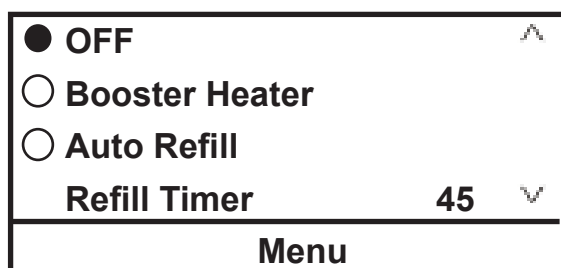

Highlight the desired accessory, press  to enable/disable.

3. With **Heater/Auto Refill** highlighted press  to display:



Highlight the desired accessory, press  to enable/disable.

**Refill Timer** is the length of time the auto refill operates if the normal reservoir level is not reached. The range is adjustable from 5 to 600 seconds.

## High Temperature Cutout

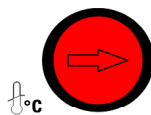

HTC (Temperature range varies with type of immersion circulator.)

To protect your application, the adjustable High Temperature Cutout (HTC) ensures the heater does not exceed temperatures that can cause serious damage. A temperature sensor is located in the reservoir. A HTC fault occurs when the temperature of the sensor exceeds the set temperature limit.

In the event of a fault the circulator shuts down and displays a fault message, see Section 7. The cause of the fault must be identified and corrected before the circulator can be restarted. A low reservoir fluid level is a primary reason for the HTC to trip.

The HTC is factory preset fully clockwise to the highest possible setting. To set the cutout start the circulator and adjust the setpoint a few degrees higher than the highest desired fluid temperature. Allow the circulator to stabilize at the temperature setpoint. Using a small diameter (less than 1/8") plastic/metal rod, turn the arrow counterclockwise until the circulator shuts down and the fault message appears. Press  to clear the message.

**Note** If using plastic rod ensure the fluid temperature is low enough to prevent possibly melting the plastic. ▲

Before you can restart the circulator it has to cool down a few degrees. To restart the circulator press the black reset ring surrounding the red dial - and then press  again. If Auto Restart is enabled the circulator restarts, if disabled use the Start Up procedure.

**Note:** We recommend periodically rechecking operation or if the circulator is moved. ▲

## Decommissioning/ Disposal

Decommissioning prepares equipment for safe and secure transportation.



**Laboratory Grade Ethylene glycol (EG) is poisonous and flammable. Before disposing refer to the manufacturer's most current SDS for handling precautions. ▲**



**Decommissioning must be performed only by qualified dealer using certified equipment. All prevailing regulations must be followed. ▲**

A45HC units utilize flammable refrigerant (R290), risk of fire or explosion. Dispose of properly in accordance with federal or local regulations.

Consider decommissioning the circulator when:

- It fails to maintain desired specifications
- It no longer meets safety standards
- It is beyond repair for its age and worth

Refrigerant (R134A) and oil (POE or Ester) used in all other refrigerated baths must be recovered from equipment before disposal.

**Note** Keep in mind any impact your application may have had on the circulator. ▲

Direct questions about chiller decommissioning or disposal to our Sales, Service and Customer Support.



**Handling and disposal should be done in accordance with the manufacturer's specification and/or the SDS for the material used. ▲**

## Storage



**If the circulator is to be transported and/or stored in cold temperatures it needs to be drained and then flushed with a 50/50 laboratory grade glycol/water mixture. ▲**

The circulator can be stored for up to 90 days inside the temperature range of -25°C to +60°C (-13°F to +140°F).

If necessary, when removing the circulator from storage allow it time to warm up and dry out in order to prevent any condensation issues.





## Section 5 Accessories

### Lifting Platform Installation



#### Tools required:

- Torx Head screwdriver
- M15 or adjustable wrench

#### Procedure:

Always turn off the circulator and disconnect the power cord from the power source before installing the platform. ▲

1. Undo the four thumbscrews securing the immersion circulator to the bridge and remove it.
2. Undo the four Torx head screws securing the bridge to the bath and remove the bridge.
3. Secure the stacks to the platform. **Note** the long end of the stack is installed into the hole on the platform as shown. ▲
4. Insert the sockets into the holes on the top of the bridge. Secure the sockets to the bridge using a M15 nut on the bottom of each socket.
5. Slide the stacks up and through the sockets on the bridge.
6. Install a male knurled nut into each socket and install a female knurled nut to the top of the stack.
7. Place the assembly in the bath and secure it to the circulator using the four Torx head screws.
8. Place the immersion circulator on the bridge and secure it using the four thumbscrews, hand tight.
9. Place the lifting platform to the desired position and lock it by using the male knurled nuts.

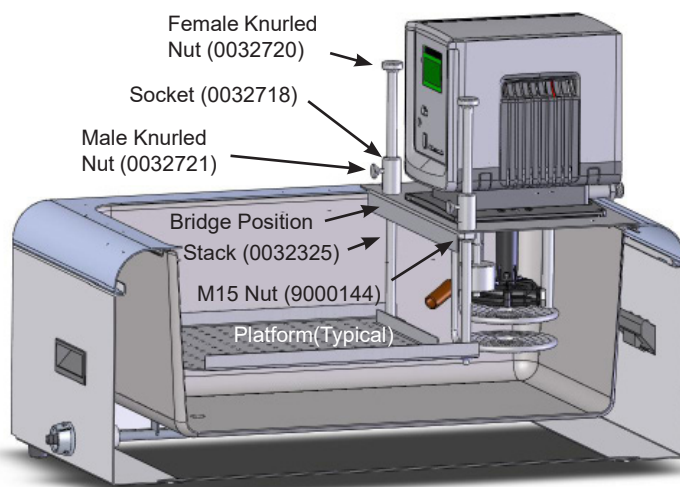

## Immersion Cooler Bridge Installation



### Tools required:

- Phillips Head screwdriver

### Procedure:

Always turn off the circulator and disconnect the power cord from the power source before installing the bridge. ▲

1. Undo the four thumbscrews securing the immersion circulator to the top panel and remove the immersion circulator.
2. Undo the four Phillips Head screws securing the top panel to the bath and remove it.
3. Turn the old panel over and note the placement of its three gaskets. Using the old panel as a template, install the three supplied gaskets in the same position on the new panel. **Note** Place the panels on a soft clean cloth, their stainless steel surfaces are susceptible to scratching. ▲
4. Place the immersion cooler bridge on the bath and secure it to the circulator using the four Phillips Head screws.
5. Place the immersion circulator on the top panel and secure it using the four thumbscrews, hand tight.
6. Remove the two screws securing the "dummy" panel to the immersion cooler bridge.
7. Insert the immersion circulator head through the hole.
8. Secure the head to the top panel using the two supplied panels.

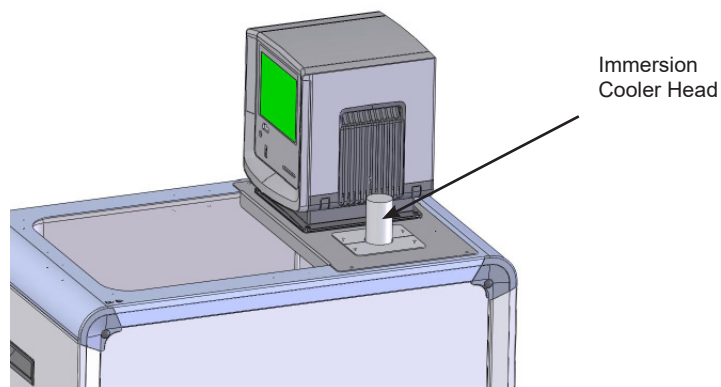

## Rack Assembly Instructions

### Tools required:

- Phillips Head screwdriver

### Procedure:

All four support parts are identical, the lower-support is the upper-support rotated 180°.

1. If required, align the top and bottom rack supports to the desired height. Install the rack supports to the base rack using the supplied screws.
2. Install any additional racks, supplied separately, at the desired height.
3. Install optional plastic inserts into the holes as needed.

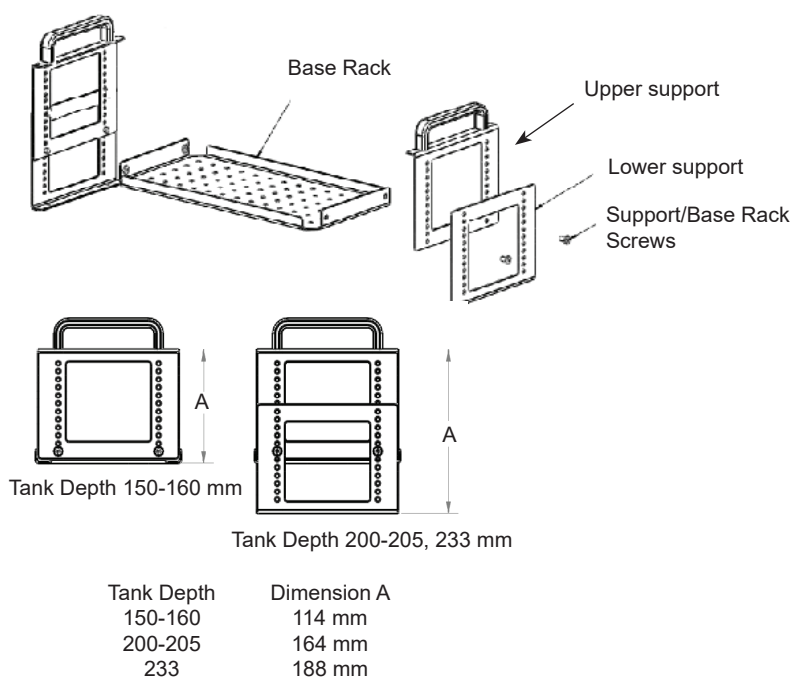

### Optional Stainless Steel Insert Racks:

**A10B, S49, S14P, S21P (283 x 145 mm)**

**A25B, A45HC, S21 (160 x 145 mm)**

**S13 (160 x 100 mm)**

- 10 mm test tube holes
- 16 mm test tube holes
- 25 mm test tube holes
- No holes

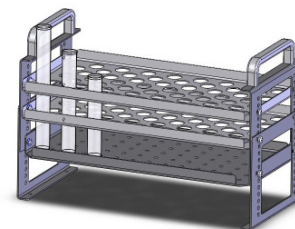

# Serial Communications Adapter



Tools required:

- None

Procedure:

Turn off the circulator before installing the adapter. ▲

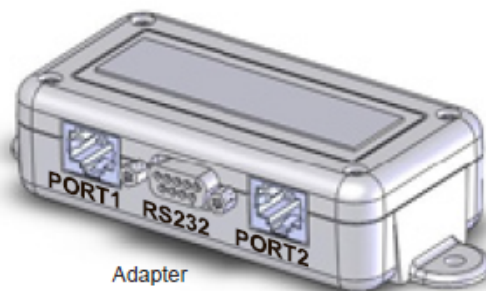

Adapter



Pin #	Function
1	No connection
2	TX
3	RX
4	No connection
5	GND = Signal ground
6 - 9	No connection



Pin #	Function
1-7	No connection
8	T+
9	T-

TX = Transmitted data from circulator  
 RX = Received data to circulator.

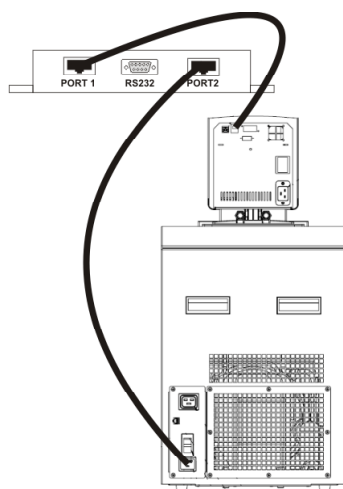

1. If the circulator already has a communication cable installed, remove the cable from the rear of the immersion circulator and plug that cable into PORT 2 on the adapter.
2. Plug the supplied cable into PORT 1 on the adapter and the other end into the immersion circulator. Regardless of the configuration, the supplied cable *always* goes from the immersion circulator to PORT 1.
3. Plug your 9-pin serial communications cable into the communication port on the adapter and then the other end into your computer. Cables are available from Thermo Fisher.
4. If desired, use the supplied Velcro<sup>®</sup> tape to attach the adapter to a convenient location on the circulator.

# MultiFunction Port Standard I/O DB-15HD (AC 200 only)



## Alarm Output Pins 13(+) and 3 (-) Open Collector Output

This output turns on (conducts) when there is an alarm. Any alarm that turns off the circulator will also set this output. An alarm message is displayed. (Maximum current on the output cannot exceed 25mA and 24 VDC.) A resistor must be supplied to limit the current, see samples below.

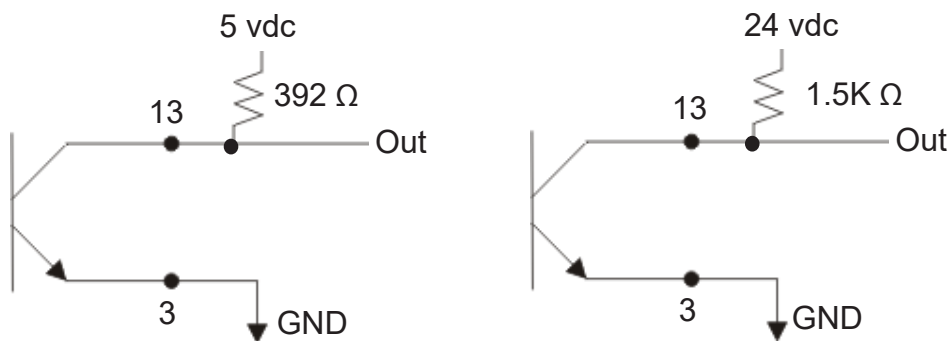

## External Alarm Input Pins 12(+) and 2 (-)

To enable this input, apply 10 - 20 mA to pins 12 and 2. This input turns off the circulator. The alarm continues to sound until the input is removed. See samples below.

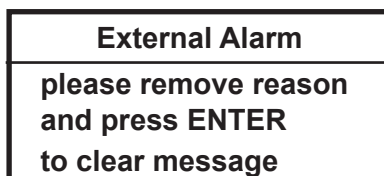

## External On/Off Input Pins 11(+) and 1 (-)

To enable this input, apply customer supplied 10 - 20 mA to bath pins 11 and 1. This input turns the circulator on and off. A message is displayed when the input turns off. The circulator logic is reversed for this input: conducting = circulator off, not conducting = circulator on. See samples below.

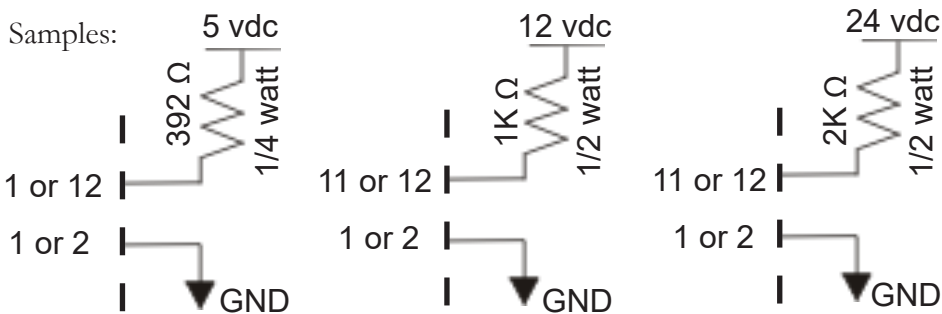
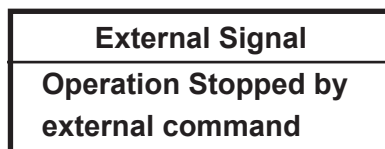

ON STATE Current = 10 - 20 mA

## Tubing

Description	Order-No.
Insulated metal tubes made from stainless steel with M 16 x 1 unions on both ends. -90 to +105 °C temperature range	
100 cm (39") long	333-0578
150 cm (59") long	333-0579
coupling	001-2560
Insulated metal tubing made from stainless steel with M 16 x 1 unions on both ends. -50 to +300 °C temperature range	
50 cm (20") long	333-0292
100 cm (39") long	333-0293
150 cm (59") long	333-0294
tube coupling	001-2560
PVC tubing (water only)	
8 mm i.d. (available per meter)	082-0745
12 mm i.d. (available per meter)	082-0304
Viton tubing -60 to +200 °C temperature range	
8 mm i.d. (available per meter)	082-1214
12 mm i.d. (available per meter)	082-1215
Silicone tubing -30 to +220 °C temperature range (not to be used with any silicone oil, i.e., SIL or Synth 60)	
8 mm i.d. (available per meter)	082-0663
12 mm i.d. (available per meter)	082-0664
Perbunan tubing -40 to +100 °C temperature range	
8 mm i.d. (available per meter)	082-0172
12 mm i.d. (available per meter)	082-0173
Foam rubber insulation for PVC, Viton, Silicone and Perbunan tubes	
8 mm i.d. (available per meter)	806-0373
12 mm i.d. (available per meter)	806-0374
Fittings for plastic tubing	
8 mm i.d.	001-1209
12 mm i.d.	001-1210
Coupling nut	001-0797



## Section 6 Preventive Maintenance



Disconnect the power cord prior to performing any maintenance. ▲

Handle the circulator with care. Sudden jolts or drops can damage its components. ▲

### Cleaning

After time, the circulator's stainless steel surfaces may show spots and become tarnished. Normal stainless steel cleaners can be used.

Clean the bath vessel and built-in components at least every time the reservoir fluid is changed. Use water and a soft cloth.



Do not use scouring powder. ▲

A45HC units utilize a flammable refrigerant (R290), risk of fire or explosion, do not use sharp objects to clean evaporator coil in the tank. The inside of the bath must be kept clean in order to ensure a long service life. Quickly remove substances containing acidic or alkaline substances and metal shavings as they could harm the surfaces causing corrosion. If corrosion (e.g., small rust marks) occurs in spite of this, cleaning with stainless steel caustic agents has proved to be suitable. Apply these substances according to the manufacturer's recommendations.



### Condenser Fins

Do not use any substances which contain solvents. ▲

In order to maintain the cooling capacity of a refrigerated bath, clean the fins two to four times per year, depending on the operating environment.

Switch off the circulator and unplug the power cord.

For ARCTIC A45HC

- 1 Remove the condenser panel.
- 2 Clean fins with brush or similar tool.
- 3 Replace the panel.

For all other refrigerated baths:

Clean the fins with compressed air.

For extreme soiling a qualified technician will need to remove the cooling compressor casing.

### Tubing

Inspect and tighten the tubing and clamps daily.

## Grounding Strap and Nut



Sahara baths, and stand-alone circulators, require immersion circulator grounding.

If the circulator is removed for any reason you must ensure the nut and washer secures to the grounding strap located on the rear of the tank top when the circulator is reinstalled. ▲

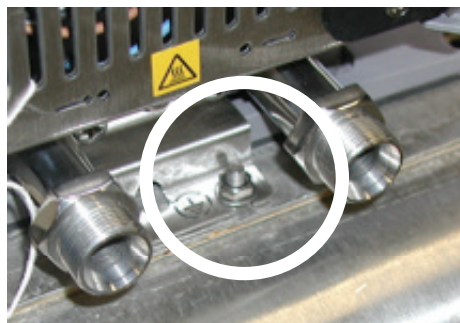

## Testing the Safety Features

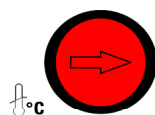

The safety features for high temperature protection and low liquid level protection must be checked at regular intervals. The frequency depends on the circulator's designated application and the heat transfer fluid used.

### High temperature protection

Using a small diameter (less than 1/8") plastic/metal rod, turn the arrow to the desired temperature.

**Note** If using plastic rod ensure the fluid temperature is low enough to prevent possibly melting the plastic. ▲

Set a cut-off temperature lower than the desired setpoint temperature. Switch on the circulator and ensure it shuts down at the set cut-off temperature.

After the circulator cools down, clear the HTC error message by pressing the black ring surrounding the red dial - and then press . If Auto Restart is enabled the circulator restarts, if disabled use the Start Up procedure.

If the circulator did not shut down have it checked by a qualified technician.

Reset the safety to the desired temperature.

### Low liquid level protection

With the circulator on, use a screwdriver and slowly push down on each level sensor, one at a time, until an error message appears. See Section 7 for details on error messages.

If not, have the circulator checked by a qualified technician.

## Error Displays

## Section 7 Troubleshooting

The circulator can display error messages and, if enabled, sound an alarm. Error messages are cleared by pressing the enter key (↵). Restart the circulator once the cause of the error message is identified and corrected. If the cause was not corrected the error code will reappear, contact our Sales, Service and Customer Support. If **Auto start** is enabled the circulator will restart, if disabled use the Start Up procedure.

**FAULT:**  
**High Temperature**  
**PRESS ENTER**  
**to clear message**









Error Display (Typical)

### Fault Displays

The heating element, pump and, if applicable, refrigeration shut down with a fault. A fault also sounds the alarm, if enabled.

Message	Cause	Actions
<b>Bath not found</b>	<ul style="list-style-type: none"> <li>a loss of communication between refrigerated bath and circulator</li> </ul>	<ul style="list-style-type: none"> <li>clear message by pressing the enter key (↵)</li> <li>check cable connections on the rear of the bath and circulator</li> </ul>
<b>High Fixed Temp.</b>	<ul style="list-style-type: none"> <li>circulator's nonadjustable high temperature protection limit exceeded</li> </ul>	<ul style="list-style-type: none"> <li>clear message by pressing the enter key (↵)</li> <li>check fluid selection</li> <li>check environmental conditions</li> </ul>
<b>High Temperature Refrigeration</b>	<ul style="list-style-type: none"> <li>high refrigeration temperature</li> </ul>	<ul style="list-style-type: none"> <li>clear message by pressing the enter key (↵)</li> <li>check voltage supply</li> <li>the refrigeration may need servicing, contact us</li> </ul>
<b>HPC High Press. Cutout</b>	<ul style="list-style-type: none"> <li>the high refrigeration pressure cutout activated</li> </ul>	<ul style="list-style-type: none"> <li>clear message by pressing the enter key (↵)</li> <li>check for obstructions to air flow</li> <li>the refrigeration may need servicing, contact us</li> </ul>

Message	Cause	Actions
<b>HTC-LLC</b>	<ul style="list-style-type: none"> <li>if the fluid level is greater than approximately 57 mm (2 1/4") below the reservoir top it is a low level fault.</li> <li>if not, high temperature protection limit exceeded</li> </ul>	<ul style="list-style-type: none"> <li>clear message by pressing the enter key (↵)</li> <li>if required, check for leaks and fill fluid to proper level</li> <li>on smaller baths, 2 - 4 liters, if the fluid is near the minimum level reducing the pump speed may eliminate nuisance messages.</li> <li>if fluid is not the issue, allow circulator to cool down to at least 10°C below the HTC setting</li> <li>turn the red knob on the HTC fully clockwise</li> <li>press the HTC's black reset ring </li> <li>press the enter key (↵) again</li> <li>reset HTC to desired setting, see Section 4</li> <li>if message reappears recycle power to circulator and repeat the procedure</li> <li>increasing the pump speed to maximum when using fluids with viscosity greater than 50Cst may eliminate nuisance messages</li> </ul>
<b>High Level</b>	<ul style="list-style-type: none"> <li>reservoir fluid level too high for safe operation</li> </ul>	<ul style="list-style-type: none"> <li>clear message by pressing the enter key (↵)</li> <li>check fluid level, drain excess fluid if required</li> <li>verify optional auto refill operation</li> </ul>
<b>LLC Low Level Cutout</b>	<ul style="list-style-type: none"> <li>reservoir fluid level too low for safe operation</li> </ul>	<ul style="list-style-type: none"> <li>clear message by pressing the enter key (↵)</li> <li>check fluid level</li> <li>check for leaks</li> </ul>
<b>Low Fixed Temp.</b>	<ul style="list-style-type: none"> <li>circulator's nonadjustable low temperature protection limit exceeded</li> </ul>	<ul style="list-style-type: none"> <li>clear message by pressing the enter key (↵)</li> <li>check fluid selection</li> </ul>

Message	Cause	Actions
<b>Low Temperature</b>	<ul style="list-style-type: none"> <li>adjustable high temperature protection limit exceeded</li> </ul>	<ul style="list-style-type: none"> <li>clear message by pressing the enter key (  )</li> <li>check limit setting</li> <li>check fluid selection</li> </ul>
<b>Motor Fault</b>	<ul style="list-style-type: none"> <li>pump is not turning due to possible motor overload</li> </ul>	<ul style="list-style-type: none"> <li>clear message by pressing the enter key (  )</li> <li>it can take over 10 minutes for the motor temperature to get low enough before the circulator can be restarted</li> <li>if the motor does not start, cycle the power</li> <li>if multiple attempts do not clear the issue the motor probably needs to be replaced, contact us</li> </ul>
<b>MOL Motor Overload</b>	<ul style="list-style-type: none"> <li>high motor overload temperature</li> </ul>	<ul style="list-style-type: none"> <li>clear message by pressing the enter key (  )</li> <li>allow circulator to cool down</li> </ul>
<b>Open RTD1 Internal</b>	<ul style="list-style-type: none"> <li>open internal temperature sensor</li> </ul>	<ul style="list-style-type: none"> <li>clear message by pressing the enter key (  )</li> <li>contact us</li> </ul>
<b>Open RTD2 External</b>	<ul style="list-style-type: none"> <li>open external temperature sensor</li> </ul>	<ul style="list-style-type: none"> <li>clear message by pressing the enter key (  )</li> <li>contact us</li> </ul>
<b>Refill Error</b>	<ul style="list-style-type: none"> <li>Reservoir did not fill within the user specified auto refill time</li> </ul>	<ul style="list-style-type: none"> <li>clear message by pressing the enter key (  )</li> <li>check water source is turned on</li> <li>check multifunction port connection</li> <li>check time specified</li> <li>check for leaks</li> </ul>
<b>Shorted RTD1 Internal</b>	<ul style="list-style-type: none"> <li>shorted internal temperature sensor</li> </ul>	<ul style="list-style-type: none"> <li>clear message by pressing the enter key (  )</li> <li>contact us</li> </ul>
<b>Shorted RTD2 External</b>	<ul style="list-style-type: none"> <li>shorted external temperature sensor</li> </ul>	<ul style="list-style-type: none"> <li>clear message by pressing the enter key (  )</li> <li>contact us</li> </ul>

### Warning Displays

The circulator will continue to run with a warning. A warning also sounds the alarm, if enabled.

Message	Cause	Actions
<b>Bad Calibration</b>	<ul style="list-style-type: none"> <li>bad temperature probe calibration</li> </ul>	<ul style="list-style-type: none"> <li>clear message by pressing the enter key (↵)</li> <li>redo calibration</li> </ul>
<b>High Temperature</b>	<ul style="list-style-type: none"> <li>adjustable high temperature protection limit exceeded</li> </ul>	<ul style="list-style-type: none"> <li>clear message by pressing the enter key (↵)</li> <li>check limit setting</li> <li>check fluid selection</li> </ul>
<b>Low Level</b>	<ul style="list-style-type: none"> <li>reservoir fluid level too low for safe operation</li> </ul>	<ul style="list-style-type: none"> <li>clear message by pressing the enter key (↵)</li> <li>check fluid level</li> <li>on smaller baths, 2 - 4 liters, if the fluid is near the minimum level reducing the pump speed may eliminate nuisance messages.</li> </ul>
<b>Low Temperature</b>	<ul style="list-style-type: none"> <li>adjustable low temperature protection limit exceeded</li> </ul>	<ul style="list-style-type: none"> <li>clear message by pressing the enter key (↵)</li> <li>check limit setting</li> <li>check fluid selection</li> </ul>

## Checklist

### Circulator will not start

Check the display for error codes, see Error Codes in this section.

Ensure the circuit protector(s) is in the on ( I ) position.

Make sure supply voltage is connected and matches the circulator's nameplate rating  $\pm 10\%$ .

### No display

Recycle the circuit protector on the rear of the circulator.

### Display reads 239°C

External temperature probe selected but no probe attached to circulator.

Attach external probe or select internal temperature sensor.

### Circulator will not circulate process fluid

Check the reservoir level. Fill, if necessary.

Check the application for restrictions in the cooling lines.

The pump motor overloaded. The pump's internal overtemperature overcurrent device will shut off the pump causing the flow to stop. This can be caused by low fluid, debris in system, operating circulator in a high ambient temperature condition or excessively confined space. Allow time for the motor to cool down.

Ensure supply voltage matches the circulator's nameplate rating  $\pm 10\%$ .

### Inadequate temperature control

Verify the setpoint.

For refrigerated baths, ensure the condenser is free of dust and debris.

Check the fluid concentration.

Ensure circulator installation complies with the site requirements in Section 3.

Ensure supply voltage matches the nameplate rating  $\pm 10\%$ .

If the temperature continues to rise, ensure your application's heat load does not exceed the rated specifications.

Enter the controller menu and ensure the ENERGY SAVER mode is on in order for the system to maintain a stable temperature.

Check for high thermal gradients (e.g., the application load is being turned on and off or rapidly changing).



### **Inadequate pump pressure**

Ensure any user installed in-line valves are in the desired position.

Ensure the circulator's process fluid outlet is connected to the application's fluid inlet and not the outlet, see Section 3.

Ensure all connections are secure and that the proper sealant/lubricant for the fitting material is used.

Keep the distance between the circulator and the application as short as possible.

Ensure tubing is straight and without bends. If diameter reductions are required, make them at the inlet and outlet of your application, not at the circulator.

### **Circulator shuts down**

Ensure  button wasn't accidentally pressed.

Ensure the circuit protector(s) is in the on (I) position.

Check the display for error codes.

Make sure supply voltage is connected and matches the nameplate rating  $\pm 10\%$ .

Restart the circulator.

### **USB Driver Not Recognized**

If your operating system does not automatically recognize the optional driver log on to:

<http://www.ftdichip.com/FTDrivers.htm>

for instructions.

Please contact Thermo Fisher Scientific Sales Service and Customer Support if you need any additional information, see inside cover for contact instructions.

# Appendix AC Serial Communications Protocol

Serial communication is accomplished either through the optional 9-pin Serial Communications Box or through the USB port on the immersion circulator. If your operating system does not automatically recognize the optional driver log on to: <http://www.ftdichip.com/FTDrivers.htm> for instructions.

**Note** This appendix assumes you have a basic understanding of communications protocols. Information on the NC, STANDARD and NAMUR protocols is available upon request.

**Note** Keypad operation is still available with serial communications enabled.

**Note** NC protocol is required to use RS485 device addressing.

All commands must be entered in the exact format shown in the tables on the following pages. The tables show all commands available, their format and responses. Controller responses are either the requested data or an error message. The controller response must be received before the host sends the next command.

The host sends a command embedded in a single communications packet, then waits for the controller's response. If the command is not understood, the controller responds with an error command. Otherwise, the controller responds with the requested data.

Commands are not case sensitive. Upper or lower case letters may be used. Commands are listed in the Commands Table, error responses are given in the Errors Table, and symbols are shown in the Key Table.

Key	
Symbol	Meaning
[B]	A binary value 0 or 1 (0 = Off, FALSE or Disable(d); 1 = On, TRUE or Enable(d)).
[CR]	Carriage return – used as the termination character.
[U]	Text representing the units associated with a value.
[V]	A value that can be requested in a read command or sent as part of a set command.
[V <sub>MAX</sub> ]	Maximum allowed value. Part of error message when set value is too high.
[V <sub>MIN</sub> ]	Minimum allowed value. Part of error message when set value is too low.

Value: Read commands return analog [V] or bit [B] values or settings, while set commands send analog or bit settings. Read commands return values in the same displayed precision. Set command messages missing the space character between the command and the setting will be rejected, as the user's intent is unclear.

Units: A read command returning an analog [V] value or setting, will include the units [U] associated with that value or setting. A set command sending an analog value will not include the units. The units returned by the complementary read command are assumed.

Termination character: A carriage return [CR] is used to terminate command and response messages. (Typically the "Enter" key on the keyboard.)

**Note** The inter-character timeout (time between transmitted characters) is set to 30 seconds. Exceeding the timeout will clear the receiver buffer and require the message to be retransmitted.

**Note** Special characters (backspace, delete, insert, etc.) are not recognized and generate error responses.

<b>Commands Table</b>			
Commands All messages from master and slave are terminated with a carriage return [CR]			
Command Description	Master Sends	Sample Slave Response (echo off)	Alternate units
Read Temperature Internal	RT	[V]C	F K
Read Temperature 2 External (optional)	RT2	[V]C	F K
Read Displayed Setpoint	RS	[V]C	F K
Read Internal RTA1 – Internal RTA5	RIRTA1 – 5	[V]C	F K
Read External RTA1 – External RTA5	RERTA1 - 5	[V]C	F K
Read Setpoint X (X = 1 to 5)	RSX	[V]C	F K
Read High Temperature Fault	RHTF	[V]C	F K
Read High Temperature Warn	RHTW	[V]C	F K
Read Low Temperature Fault	RLTF	[V]C	F K
Read Low Temperature Warn	RLTW	[V]C	F K
Read Proportional Heat Band Setting	RPH	[V]%	
Read Proportional Cool Band Setting	RPC	[V]%	
Read Integral Heat Band Setting	RIH	[V]Repeats per minute	
Read Integral Cool Band Setting	RIC	[V]Repeats per minute	
Read Derivative Heat Band Setting	RDH	[V]Minutes	
Read Derivative Cool Band Setting	RDC	[V]Minutes	
Read Temperature Precision	RTP	[V]	
Read Temperature Units	RTU	[V] C,F,K	
Read Unit On	RO	[B]	
Read External Probe Enabled (optional)	RE	[B]	
Read Auto Restart Enabled	RAR	[B]	
Read Energy Saving Mode	REN	[B]	
Read Time	RCK	hh:mm:ss	
Read Date	RDT	mm/dd/yyyy or dd/mm/yyyy	
Read Date Format	RDF	mm/dd/yyyy or dd/mm/yyyy	
Read Ramp Status (optional)	RRS	Stopped, Running, Paused	
Read Firmware Version	RVER	[V]	
Read Firmware Checksum	RSUM	[V]	
Read Unit Fault Status	RUFS	[V1, V2 , V3, V4, V5] See page A-5	
Read Ramp Program (optional)	RRP	[V1, V2 , V3, V4, V5] See SRP on page A-4	

Commands      All messages from master and slave are terminated with a carriage return [CR]		
Command Description	Master Sends	Sample Slave Response
Set Displayed Setpoint	SS [V]	OK
Set Internal RTA1 – Internal RTA5	SIRTA1 – SIRTA5 [V]	OK
Set External RTA1 – External RTA5	SERTA1 – SERTA5 [V]	OK
Set Setpoint X (X = 1 to 5)	SSX [V]	OK
Set High Temperature Fault	SHTF [V]	OK
Set High Temperature Warning	SHTW [V]	OK
Set Low Temperature Fault	SLTF [V]	OK
Set Low Temperature Warning	SLTW [V]	OK
Set Proportional Heat Band Setting	SPH [V]	OK
Set Proportional Cool Band Setting	SPC [V]	OK
Set Integral Heat Band Setting	SIH [V]	OK
Set Integral Cool Band Setting	SIC [V]	OK
Set Derivative Heat Band Setting	SDH [V]	OK
Set Derivative Cool Band Setting	SDC [V]	OK
Set Temperature Resolution	STR [V]	OK
Set Temperature Units	STU [V] C,F,K	OK
Set Unit On Status	SO [B]	OK
Set External Probe On Status (optional)	SE [B]	OK
Set Auto Restart Enabled	SAR [B]	OK
Set Energy Saving Mode	SEN [V]	OK
Set Pump Speed	SPS [V] L,M,H	OK
Set Ramp Number (optional)	SRN [V]	OK

Commands All messages from master and slave are terminated with a carriage return [CR]		
Command Description	Master Sends	Sample Slave Response
Set Ramp Program this will load defaults for all steps declared by V1	SRP [v1,v2,v3,v4,v5] V1 #of steps V2 variance V3 cycles V4 start temp V5 end state S=stop M=maintain	OK Note: If unit allows more than one ramp the ramp number must first be set.
Set Ramp Step	SRS[v1,v2,v3, v4] V1 step # V2 end temp V3 duration V4 assured soak	OK Note: If unit allows more than one ramp the ramp number must first be set and SRP defined. (0,1)
Set Ramp On Status	SRO [V] S,E,P Start, End, Pause/resume	OK Note: (P) pause toggles Pause/resume

Error Table	
Errors	
Error Description	Slave Responds
Not defined, not implemented or incorrectly formatted	? Unsupported command
Extra characters...	? Format error
Set value too high	? Maximum allowed is [V <sub>MAX</sub> ]
Set value too low	? Minimum allowed is [V <sub>MIN</sub> ]
Argument to binary set command not 0 or 1	? Value must be 0 or 1
Set command attempted while in read only mode	? Mode is read only
Set command failed (e.g. SO 1 with low level)	? Failed

## RUFS Read Unit Fault Status

This command returns 5 values. These are decimal representations of hexadecimal values. Each individual bit of the value represents a different warning, fault or status.

decimal	hex	B7	B6	B5	B4	B3	B2	B1	B0
1	1	0	0	0	0	0	0	0	1
2	2	0	0	0	0	0	0	1	0
4	4	0	0	0	0	0	1	0	0
8	8	0	0	0	0	1	0	0	0
16	10	0	0	0	1	0	0	0	0
32	20	0	0	1	0	0	0	0	0
64	40	0	1	0	0	0	0	0	0
128	80	1	0	0	0	0	0	0	0

Value	Description of bits	Value	Description of bits
V1	B0 – B5 unused B6 rtd1 shorted B7 rtd1 open	V2	B0 HTC fault B1 high RA temperature fault B2 – B7 unused
V3	B0 low level warn B1 low temperature warn B2 high temperature warn B3 low level fault B4 low temperature fault B5 high temperature fault B6 low temperature fixed fault B7 high temperature fixed fault	V4	B0 PWM heat duty cycle > 0 B1 compressor on/off B2 pump on status B3 circulator on status B4 circulator stopping B5 circulator fault status B6 unused B7 beeper on status
V5	B0 pump speed fault B1 MOL fault B2 HPC fault B3 cool icon on steady (circulator is cooling at max capacity) B4 cool icon flashing (circulator is cooling) B5 heat icon on steady B6 heat icon flashing B7 external sensor controlling		

Refer to Key table on page 1 for explanation of symbols and their meanings.

Examples:

Read Temperature:

Host

R	T		<b>CR</b>
Command		[CR]	

Controller:

2	0	.	0	C	<b>CR</b>
[V]			[U]	[CR]	

Set Setpoint:

Host

S	S		2	0	<b>CR</b>
Command			[V]	[CR]	

Controller:

O	K	<b>CR</b>
Command Accepted		[CR]

Read Temperature 2:

Host:	R	T	2	<b>CR</b>	
Controller:	2	0	.	0	C [CR]

Set Setpoint to -22°C when minimum allowed is -20°C: Minimum allowed is  $[V_{MIN}]$

Host:	S	S		-	2	2	<b>CR</b>															
Controller:	?		M	i	n	i	m	u	m	a	l	l	o	w	e	d	i	s	-	2	0	<b>CR</b>



# Warranty

Thermo Fisher Scientific warrants for 36 months from date of shipment the Thermo Scientific ADVANCED series of Immersion Circulators, ARCTIC refrigerated bath circulators, and SAHARA heated bath circulators according to the following terms.

Any part of the unit manufactured or supplied by Thermo Fisher Scientific and found in the reasonable judgment of Thermo Fisher to be defective in material or workmanship will be repaired at an authorized Thermo Fisher Repair Depot without charge for parts or labor. The unit, including any defective part must be returned to an authorized Thermo Fisher Repair Depot within the warranty period. The expense of returning the unit to the authorized Thermo Fisher Repair Depot for warranty service will be paid for by the buyer. Our responsibility in respect to warranty claims is limited to performing the required repairs or replacements, and no claim of breach of warranty shall be cause for cancellation or rescission of the contract of sales of any unit. With respect to units that qualify for field service repairs, Thermo Fisher Scientific's responsibility is limited to the component parts necessary for the repair and the labor that is required on site to perform the repair. Any travel labor or mileage charges are the financial responsibility of the buyer.

The buyer shall be responsible for any evaluation or warranty service call (including labor charges) if no defects are found with the Thermo Scientific product.

This warranty does not cover any unit that has been subject to misuse, neglect, or accident. This warranty does not apply to any damage to the unit that is the result of improper installation or maintenance, or to any unit that has been operated or maintained in any way contrary to the operating or maintenance instructions specified in this Instruction and Operation Manual. This warranty does not cover any unit that has been altered or modified so as to change its intended use.

In addition, this warranty does not extend to repairs made by the use of parts, accessories, or fluids which are either incompatible with the unit or adversely affect its operation, performance, or durability.

Thermo Fisher Scientific reserves the right to change or improve the design of any unit without assuming any obligation to modify any unit previously manufactured.

THE FOREGOING EXPRESS WARRANTY IS IN LIEU OF ALL OTHER WARRANTIES, EXPRESSED OR IMPLIED, INCLUDING BUT NOT LIMITED TO WARRANTIES OR MERCHANTABILITY AND FITNESS FOR A PARTICULAR PURPOSE.

OUR OBLIGATION UNDER THIS WARRANTY IS STRICTLY AND EXCLUSIVELY LIMITED TO THE REPAIR OR REPLACEMENT OF DEFECTIVE COMPONENT PARTS AND Thermo Fisher Scientific DOES NOT ASSUME OR AUTHORIZE ANYONE TO ASSUME FOR IT ANY OTHER OBLIGATION.

Thermo Fisher Scientific ASSUMES NO RESPONSIBILITY FOR INCIDENTAL, CONSEQUENTIAL, OR OTHER DAMAGES INCLUDING, BUT NOT LIMITED TO LOSS OR DAMAGE TO PROPERTY, LOSS OF PROFITS OR REVENUE, LOSS OF THE UNIT, LOSS OF TIME, OR INCONVENIENCE.

This warranty applies to units sold in the United States. Any units sold elsewhere are warranted by the affiliated marketing company of Thermo Fisher Scientific. This warranty and all matters arising pursuant to it shall be governed by the law of the State of New Hampshire, United States. All legal actions brought in relation hereto shall be filed in the appropriate state or federal courts in New Hampshire, unless waived by Thermo Fisher Scientific.

Thermo Fisher Scientific  
168 Third Avenue  
Waltham, Massachusetts 02451  
United States

[www.thermofisher.com](http://www.thermofisher.com)