

**Thermo Scientific  
Laboratory  
Temperature  
Control Products**

Manual Part Number U01134  
Rev. 05/29/2015

**STANDARD Series Heated  
Immersion Circulators**

SC100      SC150      SC150L



**ARCTIC Series  
Refrigerated/Heated  
Bath Circulators**

A5B            A28F            A24B  
A10B          A40             A25  
A25B          A10             A28

**SAHARA Series Heated  
Bath Circulators**

S3             S5T             S6P  
S7             S12T            S14P  
S13            S19T            S21P  
S15  
S21  
S30  
S45  
S49

**Multilingual Quick  
Start Guides**

**Installation**

**Operation**

**Basic Maintenance**



**Thermo Scientific  
Laboratory  
Temperature  
Control Products**

Manual Part Number U01134  
Rev. 05/29/2015

**STANDARD Series Heated  
Immersion Circulators**

SC100      SC150      SC150L



**ARCTIC Series  
Refrigerated/Heated  
Bath Circulators**

A5B            A28F            A24B  
A10B          A40            A25  
A25B          A10            A28

**SAHARA Series Heated  
Bath Circulators**

S3            S5T            S6P  
S7            S12T          S14P  
S13          S19T          S21P  
S15  
S21  
S30  
S45  
S49

**Multilingual Quick  
Start Guides**

**Installation**

**Operation**

**Basic Maintenance**

## Thermo Fisher Scientific

25 Nimble Hill Road  
Newington, NH 03801  
Tel : (800) 258-0830 or  
(603) 436-9444  
Fax : (603) 436-8411  
[www.thermoscientific.com/tc](http://www.thermoscientific.com/tc)

## Sales, Service, and Customer Support

25 Nimble Hill Road  
Newington, NH 03801  
Tel: (800) 258-0830  
Sales: 8:00 am to 5:00 pm  
Service and Support: 8:00 am to 6:00 pm Monday  
through Friday (Eastern Time)  
Fax: (603) 436-8411  
[service.tc.us@thermofisher.com](mailto:service.tc.us@thermofisher.com)

Dieselstrasse 4  
D-76227 Karlsruhe, Germany  
Tel : +49 (0) 721 4094 444  
Fax : +49 (0) 721 4094 300  
[info.tc.de@thermofisher.com](mailto:info.tc.de@thermofisher.com)

Building 6, No. 27  
Xin Jinqiao Rd., Shanghai 201206  
Tel : +86(21) 68654588  
Fax : +86(21) 64457830  
[info.china@thermofisher.com](mailto:info.china@thermofisher.com)

### Statement of Copyright

Copyright © 2015 Thermo Fisher Scientific. All rights reserved.

This manual is copyrighted by Thermo Fisher Scientific.

Users are forbidden to reproduce, republish, redistribute, or resell any materials from this manual in either machine-readable form or any other form.

# Table of Contents

## Quick Starts

<b>Preface</b>	<b>i</b>
Compliance .....	i
After-Sale Support .....	i
Unpacking .....	ii
Feedback.....	ii
<b>Section 1 Safety</b>	<b>1-1</b>
Safety Warnings.....	1-1
<b>Section 2 General Information</b>	<b>2-1</b>
Description .....	2-1
Immersion Circulator Specifications.....	2-1
Bath/Circulator Specifications.....	2-3
Wetted Materials.....	2-8
<b>Section 3 Installation</b>	<b>3-1</b>
Ambient Conditions .....	3-1
Immersion Circulator Only .....	3-1
Bath Circulator .....	3-2
Ventilation .....	3-3
Electrical Requirements .....	3-3
External Circulation .....	3-7
USB Port .....	3-8
Tubing.....	3-7
Approved Fluids.....	3-10
Additional Fluid Precautions .....	3-12
Filling Requirements .....	3-15
Draining.....	3-15
<b>Section 4 Operation</b>	<b>4-1</b>
STANDARD Immersion Circulator.....	4-1
Setup .....	4-2
Start Up .....	4-2
Status Display .....	4-3
Stand By Mode.....	4-3
Stopping the Circulator.....	4-3
Power Down.....	4-4
Shut Down.....	4-4
Restarting .....	4-4
Changing the Setpoint.....	4-5

	Menu Displays.....	4-6
	Menu .....	4-6
	Menu Tree .....	4-7
	Settings .....	4-8
	System.....	4-13
	High Temperature Cutout .....	4-17
	Decommissioning/Disposal.....	4-18
	Storage.....	4-18
<b>Section 5</b>	<b>Accessories .....</b>	<b>5-1</b>
	Lifting Platform Installation.....	5-1
	Immersion Cooler Bridge Installation.....	5-2
	Rack Assembly Instructions.....	5-3
	Serial Communication Adapter.....	5-4
	Tubing.....	5-5
<b>Section 6</b>	<b>Preventive Maintenance.....</b>	<b>6-1</b>
	Cleaning .....	6-1
	Condenser Fins .....	6-1
	Grounding Strap and Nut .....	6-2
	Testing the Safety Features .....	6-2
<b>Section 7</b>	<b>Troubleshooting.....</b>	<b>7-1</b>
	Error Displays .....	7-1
<b>Appendix</b>	<b>Serial Communications.....</b>	<b>A-1</b>

**Declaration of Conformity**

**RoHS Directive**

**Warranty**

**⚠️ This quick start guide is intended for initial start up only. For all other procedures you must refer to the manual. Also, if any of these steps are not clear download the manual before proceeding.**

**Safety:**

- The bath is designed for indoor use only. Never place the bath in a location where excessive heat, moisture, inadequate ventilation, or corrosive materials are present.
- Connect the bath to a properly grounded outlet.
- Never operate the equipment with a damaged line cord.
- The refrigerants are heavier than air and will replace the oxygen causing loss of consciousness. Contact with leaking refrigerant will cause skin burns. Refer to the bath's nameplate and the manufacturer's most current MSDS for handling precautions and disposal.
- Move the bath with care, sudden jolts or drops can damage its components. Always turn the equipment off and disconnect it from its supply voltage before moving it.
- Never operate damaged or leaking equipment.
- Never operate the equipment without fluid in the bath's reservoir.

**What you need to get started:**

- An adjustable wrench
- Appropriate hose or plumbing
- Appropriate size hose clamps

The circuit protection is designed to protect the circulator. The circulator's line cord is designed to act as a disconnecting device, position the circulator so it is not difficult to access the cord.

Refer to the bath nameplate on the rear of the bath for specific electrical requirements. Voltage deviations of  $\pm 10\%$  are permissible. The outlet must be rated as suitable for total power consumption.

• **Ensure the cords do not come in contact with any of the plumbing connections or tubing.**

**1A. For refrigerated baths** make all supplied communication and electrical connections prior to starting.

- **Never connect controller power inlet, B, to a power outlet. Never connect power outlet, C, to anything but the circulator.**

Install the supplied communications cable, **A**, between the circulator and the bath RJ45 connectors.

Install the power cord from the connector, **B**, to the connector on the bath, **C**. Connect the bath's power cord, **D**, to a grounded power outlet, **E**.

**1B. For non-refrigerated baths** the power supply, **B**, goes directly to a grounded power outlet, **E**.

**2. Plumbing connections for external circulation** are on the rear of the circulator.

→ ● is the return flow from the external application. ● → is the outlet flow to the external application. The connections are 16 mm O.D.

If desired, remove the union nuts and plates to install the supplied 8 or 12 mm hose barb and clamps.

- To prevent damage to the circulator's plumbing, use a 19 mm backing wrench when removing/installing the external connections.

For maximum pressure to the external application cap the pump nozzle with the supplied fitting.

Ensure the drain port on the front of the bath is closed and that all plumbing connections are secure.

To avoid spilling, place any application containers into the bath before filling. Fill the bath work area from 2.0 cm (3/4") to 5.0 cm (2") below the top.

- Avoid overfilling, oil-based fluids expand when heated.

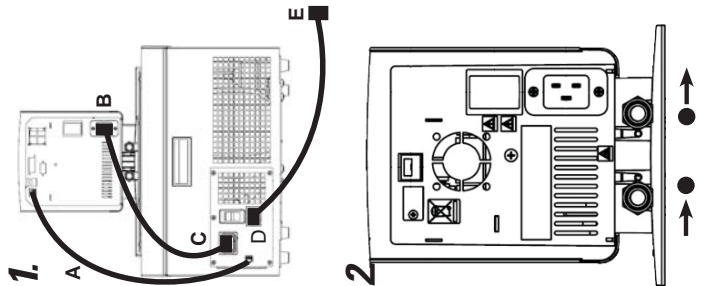

- Ensure none of the tubing comes in contact with the power cord.
- Extreme operating temperatures will lead to extreme temperatures on the tube surface, this is even more critical with metal nozzles.
- Ensure the tubing you select meets your maximum temperature and pressure requirements.
- Do not subject tubing to mechanical strain and ensure any specified bend radius is not exceeded.
- Always turn off the circulator and disconnect the power cord from the power source before installing the optional platform or bridge.
- Limit all acrylic bath's maximum high temperature setting to the temperature indicated on the label on the front of the bath, 80 °C.
- Use only the approved fluids shown in Table 1. Before using any fluid where contact with the fluid is likely, refer to the manufacturer's MSDS for handling precautions and disposal. Also, refer to the MSDS for venting requirements.

**Table 1. Approved Fluids:**

All circulators:	Filtered /single distilled water (pH 7-8)
Deionized water (1-3 MΩ-cm, compensated)	Distilled water with Nalco biocide and inhibitor
Distilled water with chlorine (5 ppm)	Distilled water with chlorine (5 ppm)
0 to 75% Laboratory Grade Glycol/Water	SC.150, SC.150L only:
SIL 100	SYNTH 60
SIL 180	SYNTH 260
	SIL. 300

- When using water above 80°C monitor the fluid level, frequent top-offs will be required. It also creates steam.
- Water/glycol mixtures require top-offs with pure water, otherwise the percentage of glycol will increase resulting in high viscosity and poor performance.



- Leave refrigerated baths in an upright position at -25°C for 24 hours before starting.

Using a flathead screwdriver, ensure the HTC is in the full clockwise position.

Do not start the circulator until fluid is added to the bath reservoir. Have extra fluid on hand.

For refrigerated baths, place its circuit protector located on the rear of the bath to the | position.

For all circulators, place the circuit protector located on the rear to the | position. The blue LED on the front panel illuminates.

3. Press , the Start Display appears. Ensure the start symbol is highlighted, if not use the arrow keys to navigate to the symbol.

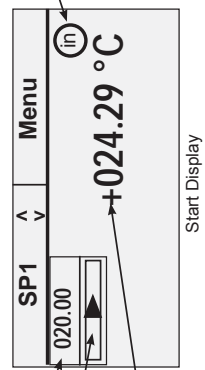

Press . The circulator starts and the start symbol turns into a stop symbol . The pump starts immediately but the compressor takes 30 seconds.

4. If desired, press to bring up the Status Display. Press to toggle between the Start/Status Displays.

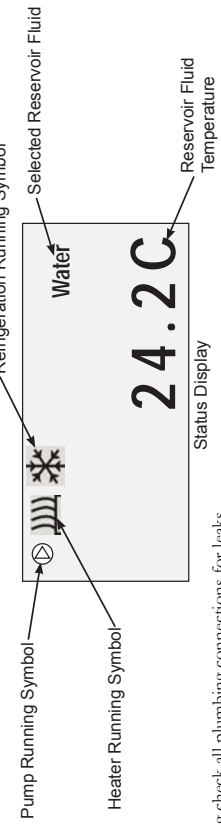

After starting check all plumbing connections for leaks. Adjust the High Temperature Cutout (HTC) safety device, refer to the manual.

**A** Diese Kurzanleitung ist nur für die erste Inbetriebnahme vorgesehen. Für alle anderen Verfahren müssen Sie im Handbuch nachsehen. Auch wenn irgendwelche Schritte unverstandlich sind, laden Sie das Handbuch herunter, bevor Sie fortfahren.

- Sicherheit:**
- Das Bad darf nur in geschlossenen Rumen betrieben werden. Stellen Sie das Bad niemals an Orten auf, an denen es ubermaiger Hitze, Feuchtigkeit, unzureichender Beluftung oder korrosiven Stoffen ausgesetzt ist.
  - Schlieen Sie das Bad an eine ordnungsgema geerdete Steckdose an.
  - Betreiben Sie das Gerat niemals mit einem beschadigten Stromkabel.
  - Da die verwendeten Kuhlmittel schwerer als Luft sind und den Sauerstoff verdrangen, kann es zu Bewusstlosigkeit kommen. Der Kontakt mit ausleitendem Kuhlmittel kann Hautverbrunnen verursachen. Informationen zu Vorsichtsmanahmen fur Umgang und Entsorgung finden Sie auf dem Typenschild des Bads sowie im aktuellen Sicherheitsdatenblatt (SDB) des Herstellers.
  - Bewegen Sie das Bad vorsichtig; plotzliche Erschutterungen oder Sturze konnen die Bauteile beschadigen. Schalten Sie das Gerat immer ab und trennen Sie es von der Versorgungsspannung, bevor Sie es bewegen.
  - Betreiben Sie niemals beschadigte oder undichte Ausrustung.
  - Betreiben Sie das Gerat niemals, solange sich keine Flussigkeit im Behalter des Bads befindet.

- Sie benotigen fur die Inbetriebnahme:**
- Einen verstellbaren Schraubenschlussel
  - Passende Schlauche bzw. Leitungen
  - Schlauchklemmen in geeigneter Groe

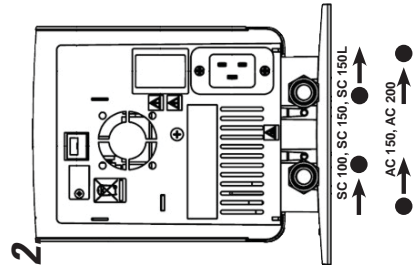
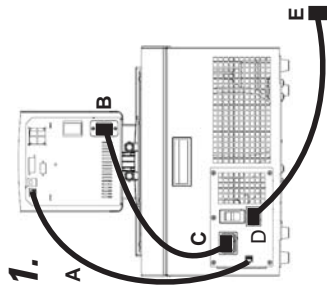

Der Stromkreischutz ist fur den Schutz des Thermostats ausgelegt. Das Stromkabel des Thermostats ist als Trennvorrichtung vorgesehen; positionieren Sie das Thermostat so, dass das Kabel gut zuganglich ist.

Die spezifischen elektrischen Anforderungen finden Sie auf dem Bad-Typenschild an der Ruckseite des Bads. Es sind Spannungsschwankungen von  $\pm 10\%$  zulassig. Die Steckdose muss als geeignet fur den Gesamtenergieverbrauch eingestuft sein.

- **Achten Sie darauf, dass die Kabel nicht mit einem der Wasseranschlusse oder den Schlauchen in Kontakt geraten.**

- 1A. Bei Kuhlbadern** mussen alle vorgesehenen Kommunikations- und Stromverbindungen vor dem Start hergestellt werden.
- **Der Stromeingang des Reglers (B) darf niemals an einen Stromausgang angeschlossen werden. Schlieen Sie den Stromausgang (C) ausschlielich an den Thermostat an.** Schlieen Sie das mitgelieferte Kommunikationskabel (A) an den RJ45-Anschlussen des Thermostats und des Bads an.
  - Schlieen Sie das Stromkabel vom Anschluss (B) an den Anschluss des Bads (C) an.
  - Schlieen Sie das Stromkabel des Bads (D) an eine geerdete Steckdose (E) an.
- 1B. Bei nicht gekuhlten Badern** verlauft die Stromversorgung (B) direkt zu einer geerdeten Steckdose (E).

- 2.** Die Wasseranschlusse fur die externe Umwalzung befinden sich an der Ruckseite des Thermostats.
- $\rightarrow$  ist der Ruckfluss von der externen Anwendung.  $\bullet$  ist der Zufluss zur externen Anwendung. Der Auendurchmesser der Anschlusse betragt 16 mm. Entfernen Sie bei Bedarf die Uberwurfmuttern und Platten, um die mitgelieferten 8 mm- bzw. 12 mm-Schlauchhulln und -klemmen zu montieren.
  - **Um Beschadigungen der Thermostatanschlusse zu vermeiden, verwenden Sie beim Entfernen/Installieren der externen Anschlusse einen 19 mm-Gabelschlussel.** Verschlieen Sie bei SC100/ SC150/ SC150L-Thermostaten die Pumpenduse mit dem mitgelieferten Anschlussstuck, um den maximalen Druck fur die externe Anwendung nicht zu uberschreiten.
- Achten Sie darauf, dass der Ablaufhahn an der Vorderseite des Bads geschlossen ist und alle Wasseranschlusse fest sitzen.
- Um ein Uberlaufen zu vermeiden, stellen Sie alle Anwendungsbehalter vor dem Befullen in das Bad.
- Befullen Sie das Bad so, dass ein Arbeitsbereich von 2,0 cm bis 5,0 cm von der Oberkante erhalten bleibt.
- **Vermeiden Sie ein Uberfullen, da Flussigkeiten auf Obasis sich unter Erwarmung ausdehnen.**

**Tabelle 1. Genehmigte Flussigkeiten:**

Alle Thermostate:  
 Filtriertes/einfach destilliertes Wasser (pH 7 bis 8)  
 Deionisiertes Wasser (1 bis 3 MO-cm, kompensiert)  
 Destilliertes Wasser mit Nalco Biozid und Inhibitor  
 Destilliertes Wasser mit Chlor (5 ppm)  
 Glykol-/Wasser-Gemische von 0 bis 75 % in Laborqualitat  
 Nur SC 150, SC 150L, AC 150 und AC 200:  
 SIL 100 SYNTH 60  
 SIL 180 SYNTH 260  
 SIL 300

• Wenn Sie Wasser mit einer Temperatur von uber 80 °C verwenden, uberwachen Sie den Fullstand, da ein haufiges Auffullen erforderlich sein wird. Auerdem kommt es zur Dampfbildung.

• Wasser/Glykol-Gemische mussen mit reinem Wasser nachgefullt werden, da ansonsten der Glykolananteil ansteigt, was eine hohe Viskositat und eine schlechte Leistung zur Folge hat.

- **Kuhlbader mussen vor Inbetriebnahme 24 Stunden bei ca. 25 °C aufrecht stehen.**

Starten Sie das Thermostat erst, nachdem Sie die Badflussigkeit dem Behalter hinzugegeben haben. Halten Sie zusatzliche Flussigkeit griffbereit.

Stellen Sie bei Kuhlbadern den Stromkreischutz an der Ruckseite des Bads auf die Position I. Stellen Sie bei allen Thermostaten den Stromkreischutz an der Ruckseite auf die Position I. Die blaue LED auf dem vorderen Bedienfeld beginnt zu leuchten.

**3.** Drucken Sie auf  $\uparrow$ , und die Startanzeige wird angezeigt. Stellen Sie sicher, dass das Start-Symbol  $\blacktriangle$  hervorgehoben ist. Sollte dem nicht so sein, verwenden Sie die Pfeiltasten, um zu dem Symbol zu navigieren.

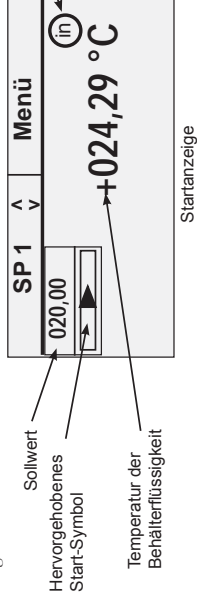

Drucken Sie auf  $\leftarrow$ . Das Thermostat wird gestartet, und das Start-Symbol verwandelt sich in das Stopp-Symbol  $\blacksquare$ . Die Pumpe wird sofort gestartet; der Kompressor erst nach 30 Sekunden.

**4.** Drucken Sie ggf. auf  $\rightarrow$ , um die Statusanzeige einzublenden. Drucken Sie auf  $\rightarrow$ , um zwischen der Start- und der Statusanzeige umzuschalten.

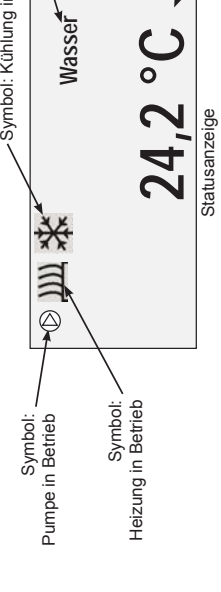

Uberprufen Sie nach dem Starten alle Wasseranschlusse auf undichte Stellen. Stellen Sie den Ubertemperaturschutz (HTC) ein; siehe Handbuch. Drucken und halten Sie  $\rightarrow$  funf Sekunden lang, um in das Sprachauswahlmenu zu gelangen.



**A Ce guide de démarrage rapide est destiné à la mise en marche initiale uniquement. Pour toute autre procédure, merci de vous référer au manuel. De plus, si l'une de ses étapes ne vous paraît pas claire, télécharger le manuel avant de commencer.**

**Sécurité :**

- Les baigns ont été conçus pour fonctionner exclusivement à l'intérieur. Ne jamais exposer le bain à une chaleur ou une humidité excessive, à une ventilation inadéquate ou à des matières corrosives.
- Brancher le bain à une prise correctement reliée à la terre.
- Ne jamais faire fonctionner un appareil dont le cordon d'alimentation est endommagé.
- Les réfrigérants sont plus lourds que l'air et peuvent remplacer l'oxygène, provoquant ainsi une perte de connaissance. Tout contact avec des réfrigérants qui fument peut provoquer des brûlures cutanées. Pour plus d'informations concernant les précautions d'utilisation et de mise au rebut, se reporter à la plaque signalétique du bain et à la Fiche de données de sécurité (MSDS) du fabricant la plus récente.
- Déplacer le bain avec soin, les secousses soudaines et les chutes pouvant endommager ses composants. A chaque déplacement de l'équipement, toujours le mettre hors tension et le débrancher de son alimentation.
- Ne jamais utiliser jamais un équipement endommagé ou qui présente des fuites.

**Matériel nécessaire pour commencer :**

- Clé à molette
- Tuyau et accessoires de plomberie appropriés
- Colliers de serrage de dimension appropriée

**1.** Le dispositif de protection du circuit est conçu pour protéger le circulateur. Le cordon d'alimentation du circulateur est conçu pour servir de dispositif de déconnexion. Placer ainsi le circulateur de sorte à pouvoir accéder facilement au cordon.

La plaque signalétique située à l'arrière du bain en indique les caractéristiques électriques spécifiques. Les écarts de tension admissibles sont de  $\pm 10\%$ . La prise doit prendre en charge la puissance totale de l'appareil.

• S'assurer que les câbles n'entrent pas en contact avec les raccords électriques des tuyaux ou la tuyauterie.

**1A. Bains réfrigérés :** effectuer tous les raccords électriques et de communication avant le démarrage du système.

• Ne jamais raccorder la prise d'alimentation du contrôleur (B) à une prise de courant. Toujours, et uniquement, raccorder la prise de courant (C) à un circulateur.

Installer le câble de communication fourni (A) entre le circulateur et les connecteurs RJ45 du bain.

Raccorder le cordon d'alimentation du connecteur (B) au connecteur du bain (C). Brancher le cordon d'alimentation du bain (D) sur une prise de courant avec mise à la terre (E).

**1B. Bains non réfrigérés :** l'alimentation électrique (B) doit être reliée directement à une prise de courant avec mise à la terre (E).

**2.** Les raccords du circuit externe se trouvent à l'arrière du circulateur.

→ ● correspond au flux de retour de l'application externe. ● → correspond au flux de sortie vers l'application externe. Les raccords ont un diamètre extérieur de 16 mm.

Au besoin, retirer les écrous-raccords et les plaques afin d'installer les raccords cannelés et les colliers de serrage de 8 mm ou 12 mm fournis.

• Afin d'éviter d'endommager la tuyauterie du circulateur, utiliser une clé de maintien de 19 mm pour retirer/installer les connexions externes.

Sur le couvercle des circulateurs STANDARD, la base de la pompe et les accessoires fournis garantissent une pression maximale vers l'application externe.

S'assurer que l'orifice de vidange, situé à l'avant du bain est fermé et que tous les raccords de tuyauterie sont sécurisés (verrouillés et étanchés).

Pour éviter les débordements, placer les contenants de l'application dans le bain avant de remplir ce dernier.

Remplir la zone de travail du bain entre 2,0 et 5,0 cm en dessous du bord supérieur.

• Éviter de trop remplir le bain, les liquides à base d'huile augmentant de volume avec la chaleur.

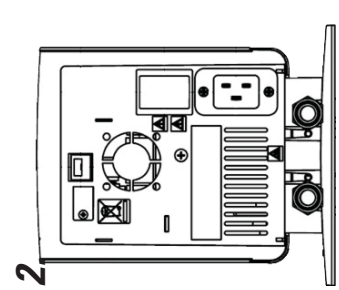
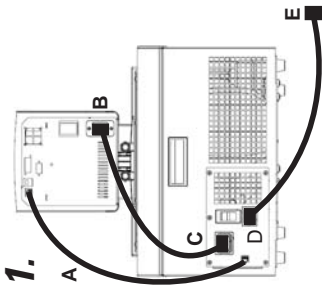

**Tableau 1. Liquides approuvés :**

Tous les circulateurs :

- Eau filtrée/mono-distillée (pH 7-8)
- Eau désionisée (1 à 3 MQ-cm, compensée)
- Eau distillée avec brocide Nalco et ses inhibiteurs
- Eau distillée avec chlore (5 ppm)
- Glycol de qualité laboratoire/ eau 0 à 75 %

SC 150, SC 150 L, AC 150 et AC 200 uniquement :

- SIL 100 SYNTH 60
- SIL 180 SYNTH 260
- SIL 300

• Lorsque la température de l'eau est supérieure à 80°C, surveiller le niveau des liquides. Il devra être régulièrement complété. De la vapeur d'eau est également générée.

• Les mélanges d'eau et de glycol doivent être réglés et complétés par de l'eau pure. Si tel n'est pas le cas, le pourcentage de glycol augmente, ce qui accroît la viscosité du mélange et diminue ses performances.

• Laisser les bains réfrigérés à la verticale et à environ 25°C pendant 24 heures avant toute mise en marche.

Ne pas démarrer le circulateur tant que le réservoir du bain ne contient pas de liquide. Conserver une quantité de liquide supplémentaire à proximité.

Bains réfrigérés : placer le dispositif de protection du circuit situé à l'arrière du bain sur la position I.

Tous les circulateurs : placer le dispositif de protection du circuit situé à l'arrière sur la position I. La LED bleue située sur le panneau avant s'allume.

**3.** Appuyer sur **ESC** pour afficher l'écran de démarrage. Vérifier que le symbole de démarrage **ESC** est en surbrillance. Si tel n'est pas le cas, le sélectionner à l'aide des touches fléchées.

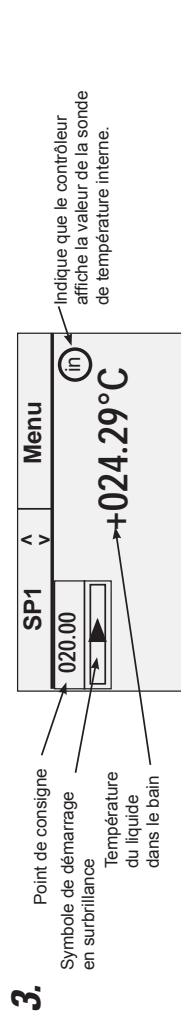

Appuyer sur **ESC**. Le circulateur démarre et le symbole de démarrage se transforme en symbole d'arrêt **ESC**. La pompe démarre immédiatement tandis que le compresseur démarre au bout de 30 secondes.

**4.** Au besoin, appuyer sur **ESC** pour appeler l'écran d'état. Appuyer sur **ESC** pour basculer entre l'écran de démarrage et l'écran d'état.

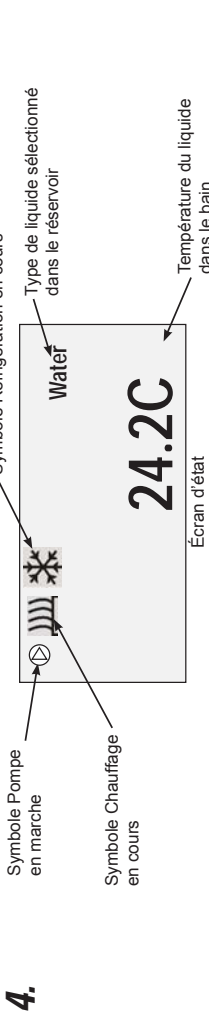

Après le démarrage, vérifier tous les raccords de tuyauterie à la recherche d'éventuelles fuites. Régler le dispositif de sécurité du point de coupure haute température (HTC). Se reporter au manuel d'utilisation.

**Esta guía de puesta en marcha rápida se ha elaborado únicamente para el arranque inicial. Para obtener información sobre otros procedimientos, debe consultar el manual. Asimismo, en caso de que tuviera dudas sobre alguno de estos pasos, descargue el manual antes de continuar.**

**Seguridad:**

- El baño está destinado exclusivamente para uso en interiores. No lo coloque nunca en lugares con calor o humedad excesivos o ventilación inadecuada, ni en presencia de materiales corrosivos.
- Conecte el baño a una toma de tierra adecuada.
- En caso de que el cable de alimentación esté dañado, no utilice el equipo.
- Los refrigerantes son más pesados que el aire, por lo que sustituirán al oxígeno y provocarán la pérdida del conocimiento. En caso de que entre en contacto con el refrigerante procedente de fugas, se producirán quemaduras en la piel. Consulte la placa identificativa del baño y la hoja de datos de seguridad de materiales (MSDS) más actual del fabricante para obtener información sobre la eliminación y las precauciones de manipulación.
- Mueva el baño con cuidado, ya que los saltos repentinos pueden dañar los componentes. Apague siempre el equipo y desconecte de la tensión eléctrica antes de moverlo.
- Nunca ponga en funcionamiento un equipo que esté dañado o que presente fugas.
- No utilice el equipo hasta que haya añadido el líquido al depósito de baño.

**Tabla 1. Líquidos aprobados:**

Todos los circuladores:  
 Agua filtrada/destilada (pH 7 - 8)  
 Agua desionizada (1-3 MΩ-cm, compensada)  
 Agua destilada con inhibidor y biocida Nalco  
 Agua destilada con cloro (5 ppm)  
 Agua/glicol para laboratorio al 0 - 75 %

SC 150, SC 150L, AC 150 y AC 200 únicamente:  
 SIL 100 SYNTH 60  
 SIL 180 SYNTH 260  
 SIL 300

• Al utilizar agua por encima de 80 °C para monitorizar el nivel de líquido, será necesario rellenar el líquido con frecuencia. Además, también se origina vapor.

• En las mezclas de agua/glicol, es necesario rellenar con agua pura; de lo contrario, aumentará el porcentaje de glicol y se producirá un aumento de la viscosidad y una disminución del rendimiento.

**Materiales necesarios:**

- Manguera o elementos de fontanería apropiados
- Abrazaderas de manguera de tamaño adecuado

La protección del circuito está diseñada para proteger el circulador. El cable de alimentación del circulador está diseñado para actuar como dispositivo de desconexión; coloque el circulador de forma que permita acceder al cable con facilidad.

Consulte los requisitos eléctricos concretos que aparecen en la placa con el nombre del baño, situada en la parte trasera. Se permite una desviación de tensión de  $\pm 10\%$ . La toma de corriente debe admitir el consumo de energía total.

• Asegúrese de que los cables no entren en contacto con los tubos ni con las conexiones de fontanería.

**1. Para baños refrigerados:** establezca todas las conexiones eléctricas y de comunicación suministradas antes de comenzar.

• Nunca conecte la entrada de alimentación del controlador, **B**, a una toma de corriente. Nunca conecte la toma de alimentación, **C**, a ningún otro aparato que no sea un circulador.

Instale el cable de comunicaciones suministrado, **A**, entre el circulador y los conectores RJ45 del baño.

Instale el cable de alimentación del conector, **B**, al conector del baño, **C**. Conecte el cable de alimentación del baño, **D**, a una toma de corriente con derivación a tierra, **E**.

**1B. Para baños no refrigerados:** la fuente de alimentación, **B**, se conecta directamente a una toma de corriente con derivación a tierra, **E**.

2. Las conexiones de fontanería para la circulación externa se encuentran en la parte trasera del circulador.

→ representa el flujo de retorno procedente de la aplicación externa.  
 ● representa el flujo de salida hacia la aplicación externa. Las conexiones tienen un diámetro externo de 16 mm.

Si lo desea, retire las placas y tuercas para instalar las abrazaderas y conexiones dentadas de 8 o 12 mm que se suministran.

• Para evitar que se produzcan daños en la fontanería del circulador, utilice una llave inglesa fija de 19 mm para retirar o instalar las conexiones externas.

En circuladores SC100, SC150, SC150L, tape la boquilla de la bomba con el accesorio suministrado para obtener la máxima presión en la aplicación externa.

Asegúrese de que el orificio de desagüe, situado en la parte delantera del baño, esté cerrado y de que todas las conexiones de fontanería estén bien apretadas.

Para evitar salpicaduras, introduzca los recipientes de la aplicación en el baño antes de llenarlo.

Llene el área de trabajo del baño dejando entre 2,0 cm (0,75 pulg.) y 5,0 cm (2 pulg.) por debajo del tope.

• No llene el baño en exceso; los líquidos a base de aceite se expanden con el calor.

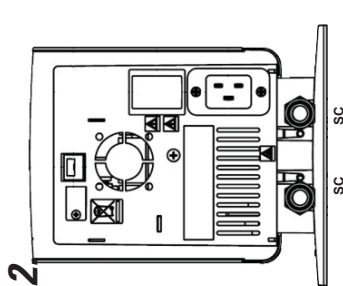
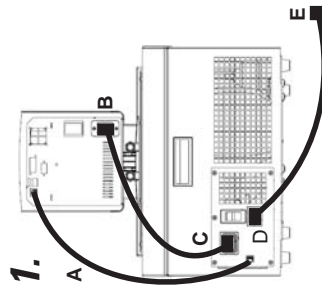

3. Pulse **ESC** y aparecerá la pantalla de inicio. Asegúrese de que el símbolo de inicio **▶** aparece resaltado; en caso contrario, utilice las teclas de flecha para desplazarse hasta el símbolo.

**3.** Valor de referencia: 020.00  
 Símbolo de inicio resaltado  
 Temperatura del líquido del depósito: +024.29 °C

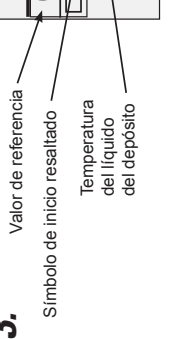

Pulse **ESC**. El circulador arrancará y el símbolo de inicio se convertirá en un símbolo de parada **■**. La bomba se inicia automáticamente, pero el compresor tarda 30 segundos.

4. Si lo desea, pulse **ESC** para que aparezca la pantalla de estado. Pulse **ESC** para alternar entre las pantallas de inicio y estado.

**4.** Símbolo de funcionamiento de la bomba  
 Símbolo de funcionamiento del calentador

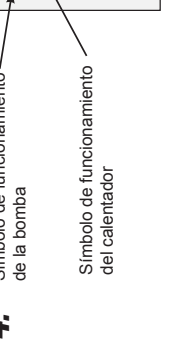

Una vez puesta en marcha la unidad, revise todas las conexiones de fontanería para detectar posibles fugas. Ajuste el corte de temperatura alta (HTC) del dispositivo de seguridad; consulte el manual.

**A** La presente guida rapida è destinata a fornire indicazioni riguardanti esclusivamente la messa in servizio. Per qualsiasi altra procedura fare riferimento al manuale. Qualora in questa guida rapida siano presenti passaggi poco chiari, scaricare il manuale prima di procedere.

- Sicurezza:**
- Il bagno è destinato esclusivamente all'utilizzo in ambienti chiusi. Non posizionare mai il bagno in un luogo eccessivamente caldo o nel quale siano presenti umidità, ventilazione inadeguata o materiali corrosivi.
  - Collegare il bagno ad una presa dotata di messa a terra.
  - Non azionare mai l'apparecchio in presenza di un cavo di alimentazione danneggiato.
  - I refrigeranti sono più pesanti dell'aria e sostituiscono l'ossigeno causando perdita di coscienza. Il contatto con eventuali perdite di refrigerante può causare ustioni cutanee. Fare riferimento alla targhetta e all'ultima scheda di sicurezza sui materiali (MSDS) fornite dal produttore per le indicazioni su gestione e smaltimento.
  - Spostare il bagno con cautela; sobbalzi improvvisi o cadute possono danneggiare i componenti. Spegnerne sempre l'apparecchio e scollegare il cavo di alimentazione prima di spostarlo.
  - Non azionare mai apparecchi danneggiati o che presentino perdite.
  - Non azionare mai l'apparecchio senza aver inserito il liquido nel serbatoio del bagno.

**Tabella 1. Liquidi approvati:**

Per tutti i circolatori:  
 Acqua filtrata/a singola distillazione (pH 7-8)  
 Acqua deionizzata (1-3.MΩ-cm, compensata)  
 Acqua distillata con biocida e inibitore Nalco  
 Acqua distillata con cloro (5 ppm)  
 Soluzione di glicole e acqua a grado di laboratorio da 0 a 75%

Solo per SC 150, SC 150L, AC 150 e AC 200:  
 SIL 100 SYNTH 60  
 SIL 180 SYNTH 260  
 SIL 300

- Monitorare il livello del liquido quando si utilizza acqua oltre gli 80 °C, potrebbero essere necessari rabbocchi frequenti. Viene inoltre generato vapore.
- Le miscele di acqua/glicole richiedono rabbocchi con acqua pura; in caso contrario, la percentuale di glicole aumenta determinando un incremento della viscosità a discapito del rendimento.

**Elementi necessari per iniziare:**

- Una chiave inglese
- Tubature adeguate
- Fascette per tubi di dimensioni adeguate

La protezione di circuito serve a proteggere il circolatore. Il cavo di alimentazione del circolatore è progettato per funzionare quale dispositivo di interruzione; posizionare il circolatore in modo tale che il cavo possa essere raggiunto con facilità.

Fare riferimento alla targhetta del bagno posta sul retro del bagno stesso per i requisiti elettrici. Sono ammesse deviazioni di tensione di  $\pm 10\%$ . La presa deve essere ritenuta idonea per il consumo di energia totale.

- Assicurarsi che i cavi non entrino in contatto con i collegamenti dei tubi o con i tubi stessi.
- 1A. Per i bagni refrigerati** eseguire tutti i collegamenti elettrici e di comunicazione presentati prima di iniziare.
- 1B. Per i bagni non refrigerati** il cavo di alimentazione, **B**, deve essere collegato direttamente a una presa di corrente dotata di messa a terra, **E**.
- Installare il cavo di comunicazione fornito, **A**, tra il circolatore e i connettori RJ45 del bagno.
- Installare il cavo di alimentazione del connettore, **B**, al connettore posto sul bagno, **C**. Collegare il cavo di alimentazione del bagno, **D**, a una presa di corrente dotata di messa a terra, **E**.

**2.** I collegamenti dei tubi per la circolazione esterna si trovano sul lato posteriore del circolatore.

→ indica il flusso di ritorno dall'applicazione esterna. ● → indica il flusso di uscita verso l'applicazione esterna. I connettori hanno un diametro esterno di 16 mm.

Se lo si desidera, rimuovere i dadi e le piastre di raccordo e installare le fascette e i raccordi da 8 o da 12 mm forniti.

**• Onde evitare danni alle tubature del circolatore, usare una controchiave da 19 mm per la rimozione/installazione dei collegamenti esterni.**

Sui circolatori SC 100, SC 150 SC150L, chiudere l'ugello della pompa con l'accessorio fornito per ottenere la massima pressione verso l'applicazione esterna.

Assicurarsi che la portella di scarico posta sul lato anteriore del bagno sia chiusa e che tutti i collegamenti dei tubi siano fissati.

Onde evitare riversamenti, posizionare tutti i contenitori nel bagno prima di procedere al riempimento.

Riemplire l'area di lavoro del bagno fino a 2,0 cm (3/4") — 5,0 cm (2") al di sotto dell'orlo.

- Non riempire eccessivamente; i liquidi a base oleosa si espandono quando riscaldati.

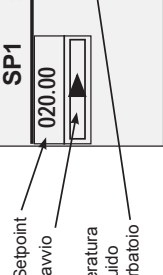

**3.** Premere **↻**; viene visualizzato il Display avvio. Assicurarsi che il simbolo di avvio **▶** sia evidenziato; in caso contrario usare i tasti di direzione per spostarsi sul simbolo.

Indica che il controller sta visualizzando il valore della sonda di temperatura interna.

Premere **↻**. Il circolatore si avvia e il simbolo di avvio si trasforma in un simbolo di interruzione **■**. La pompa si avvia immediatamente, mentre per il compressore sono necessari 30 secondi.

**4.** Se lo si desidera, premere **↻** per visualizzare il Display stato. Premere **↻** per alternare il Display avvio/stato.

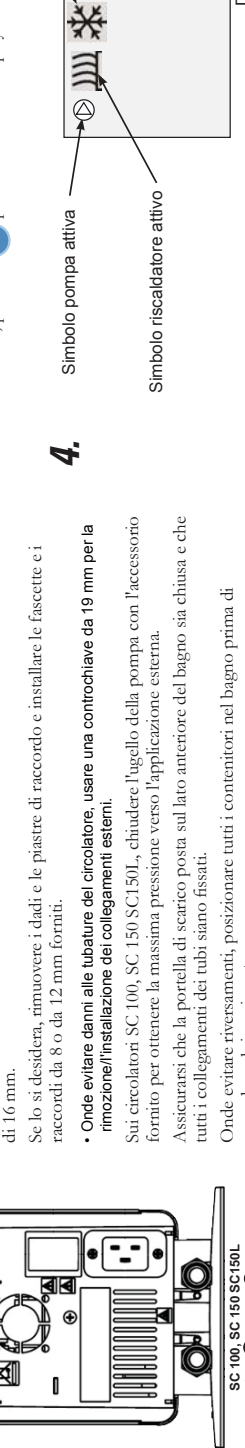

Display avvio

Display stato

Temperatura del liquido nel serbatoio

Serbatoio liquido selezionato

Water

Simbolo pompa attiva

Simbolo riscaldatore attivo

Simbolo refrigerazione in corso

Dopo l'avvio, controllare tutti i collegamenti dei tubi per escludere eventuali perdite. Regolare il dispositivo di sicurezza HTC (High Temperature Cutout); fare riferimento al manuale.



## STANDARD/ADVANCED snelstartgids

### Veiligheidsmaatregelen:

- De unit is alleen ontworpen voor gebruik binnenshuis.
- Plaats een unit nooit op een plek met overmatige warmte, vocht, onvoldoende ventilatie of corrosieve materialen.
- Gebruik nooit ontvlambare of corrosieve vloeistoffen met deze unit.
- Verzeker u ervan dat u een slang kiest die voldoet aan de vereisten voor wat betreft maximumtemperatuur en druk.
- Raadpleeg voordat u vloeistoffen gebruikt of onderhoud uitvoert op plekken waar waarschijnlijk contact is met vloeistof, de veiligheidsbladen van de fabrikant voor voorzorgsmaatregelen.

### Dit heeft u nodig om te kunnen beginnen:

- Een verstelbare steeksleutel
- Een geschikte slang of leiding
- Klemmen van de juiste grootte of type aansluiting

## 1 Elektrische/communicatie-aansluitingen

De unit is bestemd voor gebruik op een speciale uitlaat. Alle circulatiepompen zijn uitgerust met automatische thermisch getriggerte 20 Amp circuitbeveiliging.

De circuitbeveiliging is ontworpen om de circulatiepomp te beschermen, en is niet bedoeld ter vervanging van de beveiliging van afkaccircuits. Het is de verantwoordelijkheid van de gebruiker om te zorgen voor een stroomonderbreker. Stel de circulatiepomp zo op, dat het niet moeilijk is om de stroomonderbreker te bedienen.

Raadpleeg het naamplaatje van het bad op de achterste, bovenste linkerhoek van het bad voor de specifieke elektrische vereisten. Spanningsvariaties van  $\pm 10\%$  zijn toegestaan. Het nominale vermogen van het stopcontact moet geschikt zijn voor het totale stroomverbruik van de unit.

**Voor koelbaden:**  
ervoor zorgen dat alle communicatieverbindingen en elektrische aansluitingen tot stand zijn gebracht alvorens de unit te starten.

- De meegeleverde RJ45 afgeschermde kabel tussen de thermostaat kop en de RJ45 connectors van het bad installeren (als Ethernet). **Dit is nodig om een goede werking te verzekeren.**
- Bevestig de stroomkabel van de connector op de achterkant van de thermostaat kop, A, met de connector op de achterkant van het koelbad, B.
- Verbind de stroomkabel van het bad, C, met een geaard stopcontact.

**Voor koelbaden nooit de stroomingang van de controller, A, met een stopcontact verbinden. De stroomuitgang, B, nooit met iets anders dan met een thermostaat kop verbinden.**  
Ervoor zorgen dat de elektriciteitsnoeren niet in aanraking komen met de leidingaansluitingen of de slangen.

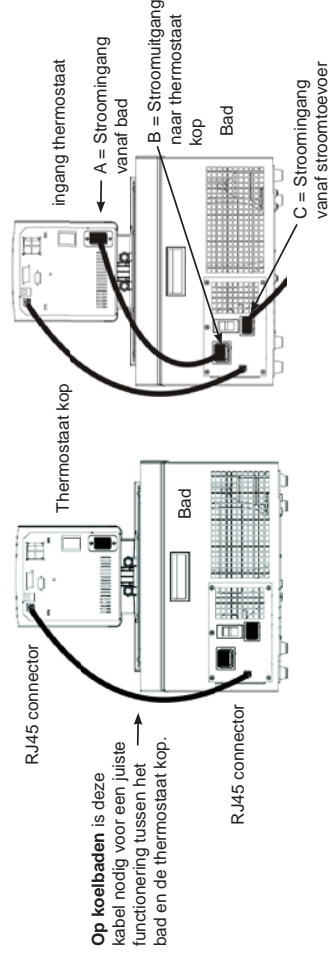

**Op koelbaden is deze kabel nodig voor een juiste functionering tussen het bad en de thermostaat kop.**

## 2 Aansluitingen en externe doorstroming

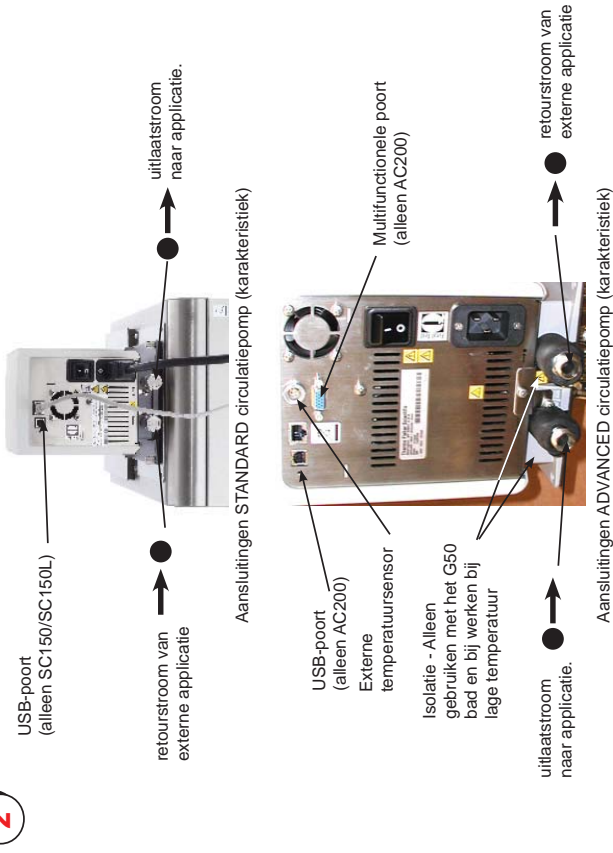

De slang wordt normaal gebruikt om de pomp te verbinden met een externe applicatie.

De leidingaansluitingen voor externe circulatie zitten op de achterkant van de circulatiepomp. Verwijder de moeren en afschermingen om bij de unit geleverde slangadapters en klemmen van de 8 mm of 12 mm slang te installeren.

**Om beschadigingen aan de slangadapters en de moeren tijdens het bevestigen of verwijderen te voorkomen, gebruik een steeksleutel nummer 19.**

**OPMERKING** Op STANDARD circulatiepompen de spuitmond van de pomp afsluiten met de bijgeleverde fitting voor maximumdruk naar de externe applicatie, zie de handleiding.

U ervan verzekeren dat het ventiel van de uitlaat van het reservoir op de voorkant van de unit *gesloten* is en dat alle leidingaansluitingen stevig vastzitten.

Om morsen te voorkomen, de vloeistofhouders van uw applicatie in het bad plaatsen voordat u gaat vullen.

Vul de opening van het bad van 2,0 cm (3/4") tot 5,0 cm (2") onder de bovenkant, zie de volgende pagina voor geschikte vloeistof.

**Niet teveel vullen, vloeistoffen op oliebasis zetten uit wanneer ze verwarmd worden.**

Wanneer er naar een extern systeem gepompt wordt, extra vloeistof bij de hand houden om het juiste peil in de circulatieleidingen en het externe systeem te handhaven. Bij het verwarmen van de vloeistof, het vloeistofpeil bewaken.

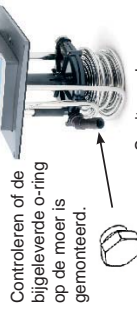

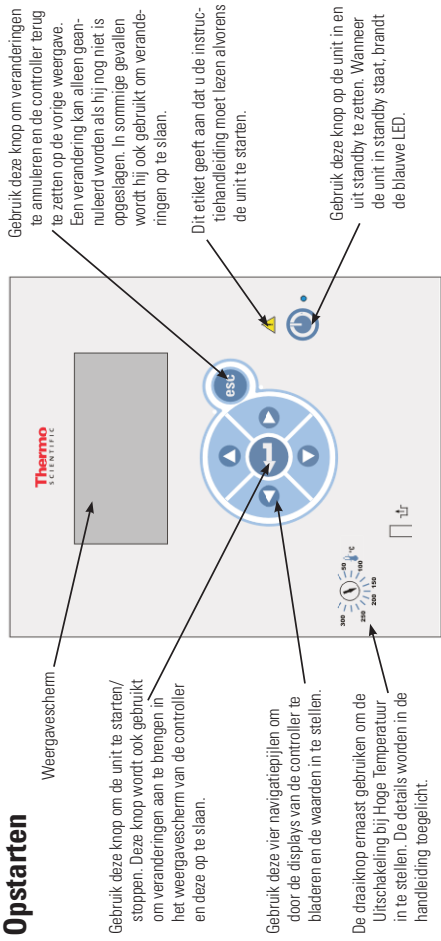

## Opstarten



**U moet koelunits 24 uur lang rechtop bij kamertemperatuur (-25 °C) laten staan alvorens ze op te starten. Op die manier kan de smeeroil teruglopen in de compressor.**

**Alvorens de unit te starten, een grondige test van alle USB-aansluitingen (optioneel), elektrische aansluitingen en leidingaansluitingen doen.**

De unit niet laten werken voordat hij met vloeistof is gevuld. Extra vloeistof bij de hand houden. Als de unit niet start, de handleiding raadplegen.

- Op koelbaden, de circuitbeveiliging op de achterkant van het bad in stand **I** zetten.
- Voor alle units, de circuitbeveiliging op de achterkant van de thermostaat kop in stand **I** zetten, de blauwe LED op het voorpaneel gaat branden
- Druk op , het Start-display verschijnt.
- Controleer of er een kader rond het stopsymbool staat, als dit niet zo is, de pijltoetsen gebruiken om naar het symbool te navigeren.
- Druk op . De unit zal starten en het startsymbool zal in een stopsymbool veranderen (  ). De pomp zal onmiddellijk starten, maar het duurt 30 seconden voor de compressor start.

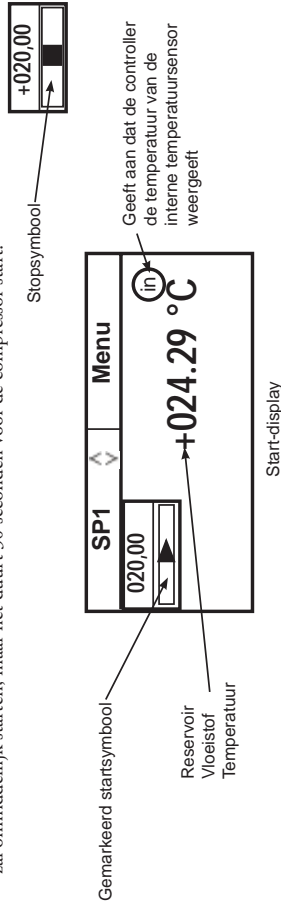

De secties **SP1** en **Menu** boven in het display worden gebruikt om de instellingen van de controller te bekijken en/of te veranderen. Ze worden in de handleiding gedetailleerd toegelicht.

Druk, indien gewenst, op  om de Status-displays op te roepen.

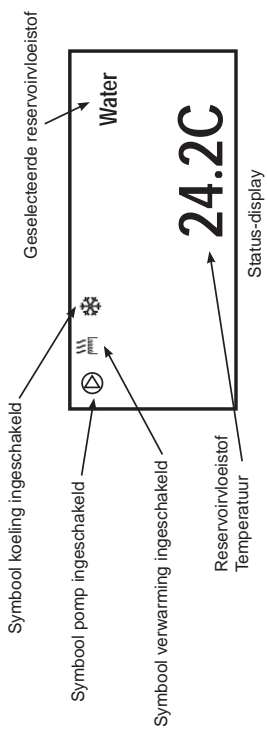

Druk, indien gewenst, op  om tussen de Start/Status-displays om te schakelen.

## Uitschakelen

Controleren of er een kader rond het stopsymbool staat, als dit niet zo is, de pijltoetsen gebruiken om naar het symbool te navigeren.

Druk op . De unit zal stoppen en het stopsymbool zal in een startsymbool veranderen (  ).

Druk op . Het scherm van de thermostaat wordt leeg en de blauwe LED licht op.

De circuitbeveiliging op de achterkant van de thermostaat kop in stand **O** zetten. De blauwe LED zal uitgaan.

Op koelunits, de circuitbeveiliging op de achterkant van het bad in stand **O** zetten.

### Acceptabele vloeistoffen:

**Alleen SC 100, SC 150 en SC 150L units**

**Systeemlimieten toegestane vloeistoffen:**

Vloeistof	Hoog °C	Laag °C
Water	+100	+5
Glycol-Water	+100	-30
Overige	+100	-30

**Alleen SC 150 en SC 150L units:**

SIL 100	+75	-28
SIL 180	+150	-28
SIL 300	+150	+80
SYNTH 60	+45	-10
SYNTH 2(0	+150	+8

### Toegestane vloeistoffen:

**Alleen AC 200/AC 150 units**

**Systeemlimieten toegestane vloeistoffen:**

Vloeistof	Hoog °C	Laag °C
Water	+100/+100	+5/+5
Glycol-Water	+100/+100	-30/-30
SIL 100	+75/+75	-75/-25
SIL 180	+200/+150	-40/-25
SIL 300	+200/+150	+80/+80
SYNTH 60	+45/+45	-50/-25
SYNTH 2("	+200/+150	+8/+8
ATMXXV	+200/+150	+8/+8

Na de start moet u alle externe leidingaansluitingen controleren op lekken.

## ⚠ Bu hızlı başlangıç kılavuzu yalnızca ilk çalışma prosedürüne yöneliktir. Diğer tüm prosedürler için kılavuza bakın. Ayrıca, burada yer alan adlarla ilgili emin olmadığınız noktalar varsa devam etmeden önce kılavuzu indirin.

### Güvenlik:

- Banyo yalnızca kapalı mekanda kullanıma yöneliktir. Banyoyu hiçbir zaman aşırı sıcak, nemli, yeterli havalandırması olmayan veya aşındırıcı maddelerin bulunduğu bir ortama yerleştirmeyin.
- Banyoyu uygun şekilde topraklanmış bir prize bağlayın.
- Güç kablosu hasarlı ekipmanı asla çalıştırmayın.
- Soğutucu akışkanlar havadan ağır olduklarından ortamdaki oksijenin yerine geçerek bilinç kaybına yol açabilir. Sızan soğutucu akışkanlarla temas edildimi ciltte yanıklara yol açar. Kullanımla ilgili önlemler ve ürünün atılması hakkında bilgi için banyonun ad plakasına ve üreticinin en güncel Malzeme Güvenlik Bilgi Formuna (MSDS) bakın.
- Banyoyu taşırken dikkatli olun; ani sarsıntılar veya ürünün düşürülmesi bileşenlere zarar verebilir. Ekipmanı taşımadan önce mutlaka kapalı konuma getirin ve şebeke bağlantısını kesin.
- Hasarlı veya sızıntı yapan ekipmanı asla çalıştırmayın.
- Banyonun haznesinde sıvı yokken ekipmanı asla çalıştırmayın.

### Başlangıç için gerekli malzemeler:

- İngiliz anahatı
- Uygun hortum veya boru
- Uygun boyda hortum kelepçeleri

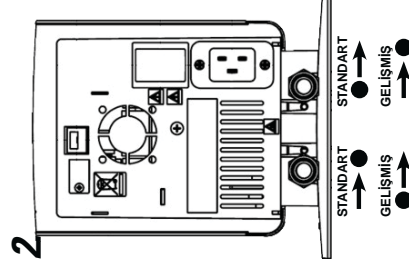
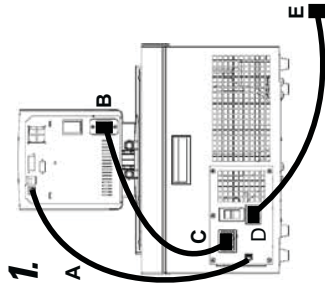

- Hortumlardan hiçbirinin güç kablosuyla temas etmediğinden emin olun.
- Aşırı çalışma sıcaklıkları tüp yüzeyinin aşırı ısınmasına yol açacaktır; bu durum, metal nozüller kullanıldığında daha da ciddi bir hal alır.
- Seçtiğiniz hortumların maksimum sıcaklık ve basınç gereksinimlerinizi karşıladığından emin olun.
- Hortumları mekanik gerilime maruz bırakmayın ve belirtilen bükme yarıçaplarının aşmadığından emin olun.
- İsteğe bağlı platformu veya köprüyü kurmadan önce mutlaka sirkülatörü kapatın ve güç kablosunun güç kaynağı bağlantısını kesin.
- Akrilik banyonun maksimum üst sıcaklık eyaarını, banyonun ön tarafındaki etikette belirtilen sıcaklık değeri olan 80°C ile sınırladın.
- Yalnızca Tablo 1'de gösterilen onaylı sıvıları kullanın. Sıvıyla teması gerçekleştirileceği yerlerde herhangi bir sıvı kullanmadan önce kullanımla ilgili önlemler ve ürünün atılması hakkında bilgi için üreticinin MSDS belgesine bakın. Havalandırma gereksinimleri için de MSDS belgesine bakın.

- Daha fazla miktarda sıvı doldurmayın; yağ bazı sıvılar ısındığından genişler.
- Daha fazla miktarda sıvı doldurmayın; yağ bazı sıvılar ısındığından genişler.

- Soğutmalı banyoları, çalıştırmadan önce ~25°C'de dik konumda 24 saat süreyle beklemeye bırakın.

Banyo haznesine sıvı eklenmeden sirkülatörü çalıştırmayın. Hazırda fazladan sıvı bulundurun.

Soğutmalı banyolar için banyonun arka tarafında bulunan devre koruyucusunu I konumuna getirin.

Tüm sirkülatörler için arka tarafa bulunan devre koruyucusunu I konumuna getirin. Ön paneldeki mavi LED yanar.

## 3

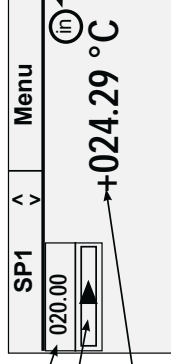

- düğmesine basın, Başlangıç Ekranı görüntülenir.

Başlat simgesinin (▶) vurgulandığından emin olun; simge vurgulanıyorsa ok tuşlarını kullanarak simgeye gidin.

düğmesine basın. Sirkülatör çalışır ve başlat simgesi durdur simgesine (■) döner. Pompa derhal çalışır, fakat kompresörün çalışması 30 saniye kadar sürer.

İsterseniz (ESC) düğmesine basarak Durum Ekranını görüntüleyebilirsiniz. Başlangıç/Durum Ekranları arasında geçiş yapmak için (ESC) düğmesine basın.

## 4

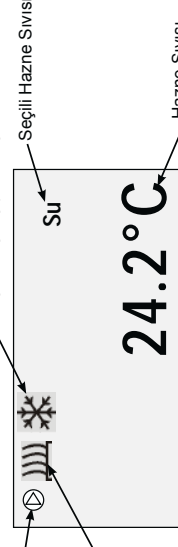

Ürünü çalıştırdıktan sonra sızıntı olup olmadığını belirlemek için tüm boru bağlantılarını kontrol edin.

Yüksek Sıcaklık Kapatma (HTC) güvenlik cihazını ayarlayın; kılavuza bakın.

Devre koruması, sirkülatörün korunması için tasarlanmıştır. Sirkülatörün hat kablosu, bağlantı kesme aracı olarak kullanılmak üzere tasarlanmıştır; sirkülatörü kabloya rahatsızlık erişilebilecek bir şekilde konumlandırın.

Spesifik elektrik gereksinimleri için banyonun arka tarafındaki ad plakasına bakın. ± %10'luk gerilim sapmalarına izin verilir. Priz, toplam güç tüketimine uygun değerde olmalıdır.

Kabloların boru bağlantılarıyla veya hortumlarla temas etmediğinden emin olun.

Soğutmalı banyolar için ürünü çalıştırmadan önce ürünü birlikte verilen tüm iletim ve elektrik bağlantılarını yapın.

- Kontrolör güç girişini (B) asla bir prize bağlamayın. Güç çıkışı (C) asla sirkülatör dışına bir yere bağlamayın.

Ürünü birlikte verilen iletim kablosunu (A) kullanarak sirkülatör ile banyo RJ45 konektörlerini birbirine bağlayın.

Güç kablosunu kullanarak konektörü (B), banyo üzerindeki konektöre (C) bağlayın. Banyonun güç kablosunu (D) topraklı bir prize (E) bağlayın.

- Soğutmasız banyolar için güç kaynağı (B) doğrudan topraklı bir prize (E) bağlan.

2. Harici sirkülasyon için boru bağlantıları sirkülatörün arka tarafında bulunmaktadır.

→ ● harici uygulamadan gelen dönüş akışdır: ● → harici uygulamaya çıkan çıkış akışdır. Bağlantılar 16 mm'lik bir dış çapa sahiptir.

İsteğe bağlı olarak, rakotdan ve plakadan sökerek ürünü birlikte verilen 8 veya 12 mm'lik hortum uçlarını ve kelepçelerini takabilirsiniz.

- Sirkülatör borularının zarar görmesini önlemek için harici bağlantıları sökerek/takarken deslek anahtar olarak bir 19 mm anahtar kullanın.

STANDART sirkülatörlerde harici uygulamaya maksimum basıncın sağlanması için ürünü birlikte verilen bağlantı parçasını pompa nozülüne takın.

Banyonun ön tarafındaki tahliye portunun kapalı olduğundan ve tüm boru bağlantılarının sabitlendiğinden emin olun.

Dökümleri önlemek için dolmuştur yapmadan önce tüm uygulama kaplarını banyonun içine yerleştirin.

Banyo çalışma alanını en üst kısımdan 2,0 cm (3/4") ile 5,0 cm (2") pay bırakarak doldurun.

Tablo 1. Onaylı Sıvılar:

- Tüm sirkülatörler: Filtrelenmiş/bir kez damıtılmış su (pH 7-8)
- Deiyonize su (1-3 MΩ-cm, dengelenmiş)
- Nalco biyosit ve inhibitör eklenmiş damıtılmış su
- Klor eklenmiş damıtılmış su (5 ppm)
- %40 İla 75 Laboratuvar Sıfır Glikol/Su
- Yalnızca SC-150, SC-150L, AC-150 ve AC-200: SIL-100 SYNTH 60
- SIL-180 SYNTH 260
- SIL-300

• 80°C'nin üzerinde su kullanırken sıvı seviyesini izleyin; sık sık ekleme yapması gerekecektir. Ayrıca buhar da oluşacaktır.

• Su/glikol karışımları saf su ile ekleme yapılmasını gerektirir; aksi halde glikol yüzdesi artarak yüksek viskoziteye ve düşük performansına neden olur.



**A** Den här snabbstartguiden är endast avsedd att användas vid den första starten. För övriga procedurer ska du läsa handboken. Om du är osäker på något av nedanstående steg ska du också ladda ned och läsa handboken innan du fortsätter.

**Säkerhet:**

- Badet är endast avsett för inomhusbruk. Placera aldrig badet på ett ställe som är onormalt varmt, fuktigt eller deligt ventilerat, eller där frätande material förekommer.
- Anslut badet till ett jordat eluttag.
- Använd aldrig utrustningen om nåttsladden är skadad.
- Kylmediet är tyngre än luft och kommer att tränga undan syret, vilket leder till medvetlöshet. Ett läckande kylmedie utsäker brännskador om det kommer i kontakt med huden. Läs märkplåten på badet och senaste MSDS:n från tillverkaren om hanteringsrutiner och kassering.
- Var försiktig när du flyttar badet. Plötsliga stötar eller fall kan skada dess komponenter. Stäng alltid av utrustningen och dra ut nåttsladden innan du flyttar den.
- Använd aldrig utrustning som är skadad eller läcker.
- Använd aldrig utrustningen om badets vätskebehållare är tom.
- Säkerställ att inga slangar kommer i kontakt med nåttsladden.

**Du behöver följande för att komma igång:**

- en skiftnyckel
- lämpliga slangar eller rör
- slangklämmor av lämplig storlek.

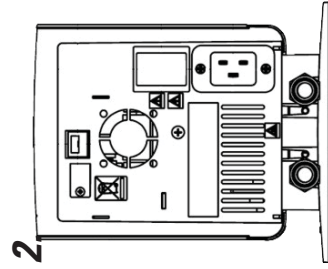
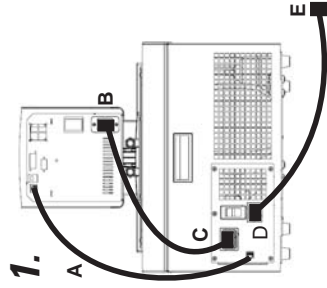

- Extrema drifttemperaturer leder till extrema temperaturer vid slangytan. Detta blir ännu mer kritiskt med metallmunstycken.
- Kontrollera att den slang du har valt uppfyller kraven för maxtemperatur och maxtryck.
- Utsätt inte slangarna för mekaniskt slitage och kontrollera att eventuella böjningsradier som angetts inte överskrids.
- Stäng alltid av cirkulatoren och dra ut nåttsladden från strömkällan innan du installerar den plattformen (tillval) eller bryggan (tillval).
- Begränsa den högsta temperaturinställningen för akrylbad till den temperatur som anges på etiketten på badets framsida: 80 °C.
- Använd endast de godkända vätskor som visas i tabell 1. Innan du använder någon vätska som kan tänkas komma i kontakt med huden ska du läsa MSDS:n från tillverkaren om hanteringsrutiner och kassering. Läs även i MSDS:n om ventilationskrav.

Kretskyddet är utformat för att skydda cirkulatoren. Nätsladden till cirkulatoren är utformat för att fungera som en fränkopplingsenhet. Placera cirkulatoren så att du enkelt kommer åt nätsladden.

Läs märkplåten på badets baksida för särskilda elektriska krav. Spänningsavvikelser på ± 10 % är tillåtna. Eluttaget måste vara klassat som lämpligt för den totala strömförbrukningen.

- Säkerställ att inte sladdarna kommer i kontakt med något av de anslutna rören eller någon av de anslutna slangarna.

**1A. För kylbad ska alla kommunikationsanslutningar och elektriska anslutningar göras före start.**

- Anslut aldrig styrenhetens strömningång (B) till ett eluttag. Strömningången C får endast anslutas till cirkulatoren.
- Anslut den medföljande kommunikationskabeln (A) mellan cirkulatoren och badets RJ45-anslutning.

Anslut strömsladden från anslutningen B till anslutningen C på badet.

Anslut badets strömsladd (D) till ett jordat eluttag (E).

**1B. För icke-kylbad går strömsladden (B) direkt till ett jordat eluttag (E).**

2. Röranslutningar för extern cirkulation sitter på baksidan av cirkulatoren.

- ● är återflödet från den externa enheten. ● → är utflödet till den externa enheten. Ytterdiametern för anslutningarna är 16 mm.

Om du vill kan du ta bort anslutningsmutterarna och tillhörande bricker och installera de medföljande slangplåttarna och slangklämmorna för 8 eller 12 mm.

- För att undvika skador på cirkulatorns rör ska en säkerhetsnyckel på 19 mm användas när de externa anslutningarna tas bort eller installeras.

På STANDARD-cirkulatorer ska den medföljande kopplingen fästas på pumpmunstycket för högsta möjliga tryck till den externa enheten. Kontrollera att dräneringsporten på badets framsida är stängd och att alla röranslutningar är säkra.

Placera eventuella enhetsbehållare i badet före fyllning för att undvika spill.

Fyll badets arbetsområde från 2,0 till 5,0 cm under den övre kanten.

- Undvik överfyllning; oljebaserade vätskor expanderar när de värms upp.
- Låt kylbad stå i upprätt läge i ~25 °C i 24 timmar före start.

**Tabell 1. Godkända vätskor:**

- Alla cirkulatorer:  
 Filtretrat/enkeldestillerat vatten (pH 7–8)  
 Avjoniserat vatten (1–3 MΩ-cm, kompenserat)  
 Destillerat vatten med Nalco-biocid/-hämmare  
 Destillerat vatten med klor (5 ppm)  
 0–75 % laboratorietklassad glykol/vatten  
 Endast SC 150, SC 150L, AC 150 och AC 200:  
 SIL 100  
 SYNTH 60  
 SIL 180  
 SYNTH 260  
 SIL 300

- Om vatten med en temperatur över 80 °C används till att övervaka vätskenivån kräver det regelbundna påfyllningar. Det bildas även ånga.
- Vatten/glykolblandningar måste fyllas på med rent vatten annars ökar procenthalten glykol, vilket leder till hög viskositet och försämrade prestanda.

Starta inte cirkulatoren förrän vätska har fyllts på i badets behållare. Se till att ha extra vätska till hands.

På kylbad ska kretskyddet på baksidan av badet ställas i läget I.

På alla cirkulatorer ska kretskyddet på baksidan ställas i läget I. Den blå lysdioden på frontpanelen tänds.

**3. Tryck på så visas startdisplaysiden.**

Kontrollera att startsymbolen lysor. Om den inte gör det använder du pilangenterna till att navigera till symbolen.

**3.**

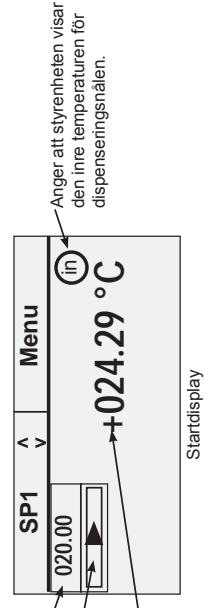

Tryck på . Cirkulatorn startar och startsymbolen ändras till en stoppsymbol . Pumpen startar direkt, men för kompressorn tar det 30 sekunder.

4. Om du vill kan du trycka på för att visa statusdisplaysiden. Tryck på för att växla mellan start- och statusdisplaysiden.

**4.**

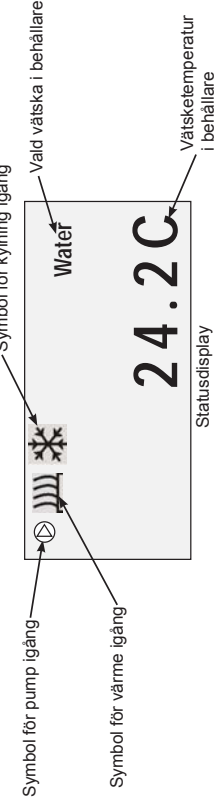

Efter start ska alla röranslutningar kontrolleras så att de inte läcker.

Justera säkerhetsniten för avstängning vid höga temperaturer (High Temperature Cutout, HTC) enligt anvisningarna i handboken.





# Preface

## Compliance

Refer to the Declaration of Conformity in the back of this manual.

## After-sale Support

Thermo Fisher Scientific is committed to customer service both during and after the sale. If you have questions concerning operation, or questions concerning spare parts or Service Contracts, call our Sales, Service and Customer Support phone number, see this manual's inside cover for contact information.

Before calling, please obtain the serial number printed on the **system nameplates** on the rear of the circulators.

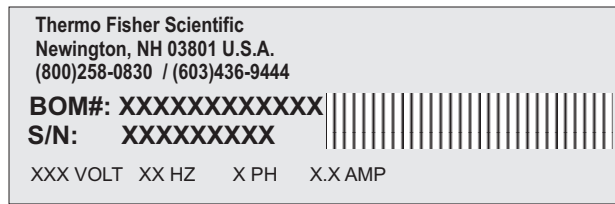

Sample Nameplate

### Nameplate

Refer to nameplate when calling for after-sale support

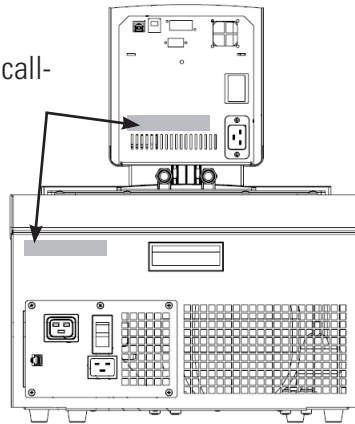

Nameplates (Typical Locations)

## Unpacking

Retain all cartons and packing material until the circulators are operated and found to be in good condition. If the circulators shows external or internal damage contact the transportation company and file a damage claim. Under ICC regulations, this is your responsibility.

If a 150/150L immersion circulator was purchased without a bath, carefully remove the label and small piece of Styrofoam securing the float switch before using.



**Leave refrigerated baths in an upright position for 24 hours before starting. This will ensure the lubrication oil has drained back into the compressor. ▲**

## Feedback

We appreciate any feedback you can give us on this manual. Please e-mail us at [tcmanuals@thermofisher.com](mailto:tcmanuals@thermofisher.com). Be sure to include the manual part number and the revision date listed on the front cover.

# Section 1 Safety

## Safety Warnings

Make sure you read and understand all instructions and safety precautions listed in this manual before installing or operating your circulator. If you have any questions concerning the operation of your circulator or the information in this manual, please contact us. See inside cover for contact information.



**DANGER** indicates an imminently hazardous situation which, if not avoided, *will* result in death or serious injury.



**WARNING** indicates a potentially hazardous situation which, if not avoided, *could* result in death or serious injury.



**CAUTION** indicates a potentially hazardous situation which, if not avoided, may result in minor or moderate injury. It also alerts against unsafe practices.



The lightning flash with arrow symbol, within an equilateral triangle, is intended to alert the user to the presence of non-insulated "dangerous voltage" within the circulator's enclosure. The voltage magnitude is significant enough to constitute a risk of electrical shock.



This label indicates the presence of hot surfaces.



This label indicates read the manual.

**Observe all warning labels. ▲**

**Never remove warning labels. ▲**

**Leave refrigerated baths in an upright position at room temperature (~25°C) for 24 hours before starting. This ensures the lubrication oil drains back into the compressor. ▲**

**The circulator's construction provides protection against the risk of electrical shock by grounding appropriate metal parts. The protection will not function unless the power cord is connected to a properly grounded outlet. It is the user's responsibility to assure a proper ground connection is provided. ▲**

**The circuit protector located on the rear of the circulator is not intended to act as a disconnecting means. ▲**

**Operate the circulator using only the supplied line cord. If the circulator's power cord is used as the disconnecting device, it must be easily accessible at all times. ▲**

**Never operate the bath with the immersion circulator removed. ▲**

Do not mount the immersion circulator backwards; the line cord could contact the reservoir fluid. Ensure the electrical cords do not contact any of the plumbing connections or tubing. ▲

Never place the circulator in a location or atmosphere where excessive heat, moisture, or corrosive materials are present. ▲

Ensure the tubing you select meets your maximum temperature and pressure requirements. ▲

Ensure all communication and electrical connections are made prior to starting the circulator. ▲

Many refrigerants which may be undetectable by human senses are heavier than air and replaces the oxygen in an enclosed area causing loss of consciousness. Refer to the circulator's nameplate and the manufacturer's most current MSDS for additional information. ▲

Never operate the circulator without fluid in the reservoir. ▲

Use only the approved fluids listed in this manual. Using other fluids voids the warranty. ▲

Transparent Acrylic Bath and Polyphenylene oxide (PPO) Bath Circulators are used with water only. ▲

Other than water, before using any approved fluid, or when performing maintenance where contact with the fluid is likely, refer to the manufacturer's MSDS and EC Safety Data sheet for handling precautions. ▲

Ensure, that no toxic gases can be generated by the fluid. Flammable gases can build up over the fluid during usage. ▲

When using ethylene glycol and water, check the fluid concentration and pH on a regular basis. Changes in concentration and pH can impact system performance. ▲

Ensure the fluid is at a safe temperature (~40°C) before handling or draining. ▲

Never operate damaged or leaking equipment, or with any damaged cords. ▲

Never operate the circulator or add fluid to the reservoir with panels removed. ▲

Do not clean the circulator with solvents, only use a soft cloth and water. ▲

Drain the reservoir before it is transported, and/or stored in, near or below freezing temperatures.

Always turn the circulator off and disconnect the supply voltage from its power source before moving or before performing any service or maintenance procedures. ▲

Transport the circulator with care. Sudden jolts or drops can damage its components. ▲

Refer service and repairs to a qualified technician. ▲

The user is responsible for decontamination if hazardous materials are spilled. Consult the manufacturer regarding decontamination and or cleaning agents compatibility. ▲

Performance of installation, operation, or maintenance procedures other than those described in this manual may result in a hazardous situation and voids the manufacturer's warranty. ▲

## Section 2 General Information

### Description

The Thermo Scientific STANDARD Series of Heated Immersion Circulators are used with refrigerated and heated baths. All circulators can pump to an external system. All controllers have a digital display and easy-to-use touch pad, five programmable setpoint temperatures, acoustic and optical alarms. SC150s and SC150Ls offer adjustable high temperature protection.

The SC100 is designed to be used only with water or glycol-water. The SC150 and SC150L have an independent low liquid level protection, and a design that allows use of different heat transfer liquids, see Section 3.

### STANDARD Heated Immersion Circulator

	SC100	SC150	SC150L
<b>Temperature Range</b> °C °F	Ambient +13 to +100 Ambient +23 to +212	Ambient +13 to +150 Ambient +23 to +302	Ambient +13 to +150 Ambient +23 to +302
<b>Temperature Stability</b> °C	±0.02	±0.02	±0.02
<b>Heater Capacity</b> 230V/115V	2000/1200 Watts	2000/1200 Watts	2000/1200 Watts
<b>Immersion Depth</b> mm inches	75 to 145 3.0 to 5.7	75 to 145 3.0 to 5.7	75 to 190 3.0 to 7.5
<b>Circulator Dimensions</b> (H x W x D) mm inches	336 x 138 x 199 13.2 x 5.4 x 7.8	336 x 138 x 199 13.2 x 5.4 x 7.8	384 x 138 x 199 15.1 x 5.4 x 7.8
<b>Net Weight</b> kg lb	3.3 7.3	3.3 7.3	3.3 7.3
<b>Pumping Capacity</b>			
<b>Electrical Requirements</b> (Voltage ±10%)	100 V/50 Hz 100 V/60 Hz or 115 V/60 Hz or 230 V/50 Hz		
<b>USB Interface</b>	No	Yes	Yes

- Performance specifications established in accordance with DIN 12 876 (using water at 70°C).
- Lower temperature ranges available with supplemental cooling.
- The maximum wall thickness for circulators that have a factory installed clamp is 26 mm.
- Thermo Fisher Scientific reserves the right to change specifications without notice.

## ARCTIC Refrigerated/Heated Bath Circulator Specifications

Stainless Steel Refrigerated/Heated Bath Circulators					
	A10	A25	A28	A28F	A40
<b>SC100 Temperature Range</b> °C °F	-10 to 100 14 to 212	-25 to 100 -13 to 212	-28 to 100 -18 to 212	-28 to 100 -18 to 212	-10 to 100 14 to 212
<b>SC150/150L Temperature Range</b> °C °F	-10 to 100 14 to 212	-25 to 150 -13 to 302	-28 to 150 -18 to 302	-28 to 150 -18 to 302	-28 to 150 -18 to 302
<b>Bath Volume</b> liters gallons	4 - 6 1.1 - 1.6	7 - 12 1.8 - 3.2	6 - 10 1.6 - 2.6	6 - 10 1.6 - 2.6	7 - 12 1.8 - 3.2
<b>Cooling Capacity</b> watts	240	500	320	320	900
<b>Refrigerant</b>	R134a	R134a	R134a	R134a	R404
<b>Overall Dimensions</b> (H x W x D)* mm inches	631 x 220 x 414 24.9 x 8.7 x 16.3	711 x 273 x 483 28.0 x 10.7 x 19.0	711 x 273 x 483 28.0 x 10.7 x 19.0	520 x 514 x 426 20.5 x 20.2 x 16.8	749 x 385 x 519 29.5 x 15.2 x 20.4
<b>Work Area Dimensions</b> (D x W x L) mm inches	150 x 137 x 124 5.9 x 5.4 x 4.9	200 x 173 x 184 8.0 x 6.8 x 7.2	200 x 173 x 129 8.0 x 6.8 x 5.1	200 x 173 x 129 8.0 x 6.8 x 5.1	200 x 173 x 184 8.0 x 6.8 x 7.2
<b>Net Weight</b> kg/lb	27.5/60.6	36.1/79.5	36.0/79.1	35.6/78.3	55.2/121.5
<b>Electrical Requirements**</b> (Voltage ±10%)	100 V/50 Hz 100 V/60 Hz or 115 V/60 Hz or 230 V/50 Hz				

Stainless Steel Refrigerated/Heated Bath Circulators				
	A5B	A10B	A24B	A25B
<b>SC100 Temperature Range</b> °C °F	-5 to 100 23 to 212	-10 to 100 14 to 212	-24 to 100 -11 to 212	-25 to 100 -13 to 212
<b>SC150/150L Temperature Range</b> °C °F	-5 to 100 23 to 212	-10 to 100 14 to 212	-24 to 150 -11 to 302	-25 to 150 -13 to 302
<b>Bath Volume</b> liters gallons	12 - 21 3.2 - 5.5	17 - 30 4.5 - 7.9	16 - 27 4.2 - 7.1	13 - 21 3.4 - 5.5
<b>Cooling Capacity</b> watts	200	250	900	500
<b>Refrigerant</b>	R134a	R134a	R404	R134a
<b>Overall Dimensions</b> (H x W x D)* mm inches	471 x 429 x 738 18.5 x 16.9 x 29.1	471 x 429 x 913 18.5 x 16.9 x 35.9	574 x 765 x 610 22.6 x 30.1 x 24.0	740 x 324 x 541 29.1 x 12.8 x 21.3
<b>Work Area Dimensions</b> (D x W x L) mm inches	200 x 297 x 190 7.9 x 11.7 x 7.5	200 x 297 x 365 7.9 x 11.7 x 13.4	200 x 297 x 313 7.9 x 11.7 x 12.3	233 x 224 x 244 9.2 x 8.8 x 9.6
<b>Net Weight</b> kg/lb	40.0/88.9	44.5/97.9	58.6/128.9	42.3/93.1
<b>Electrical Requirements**</b> (Voltage ±10%)	100 V/50 Hz 100 V/60 Hz or 115 V/60 Hz or 230 V/50 Hz			

\*Add ~26 mm (1 inch) to D for drain fitting.

\*\*See Section 3 for additional information.

- Thermo Fisher Scientific reserves the right to change specifications without notice.

## Cooling Capacity

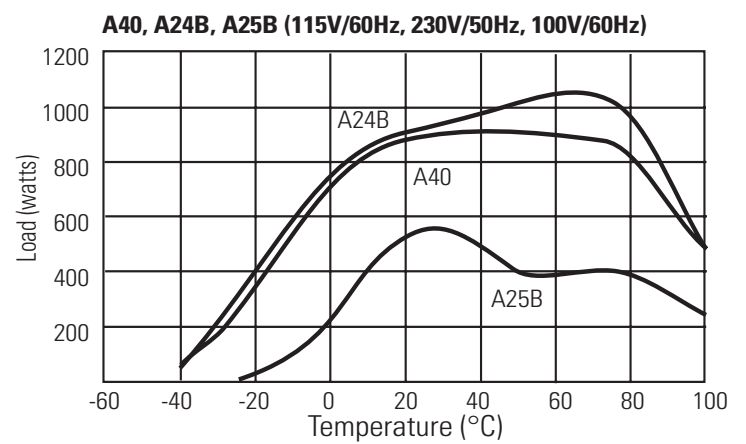
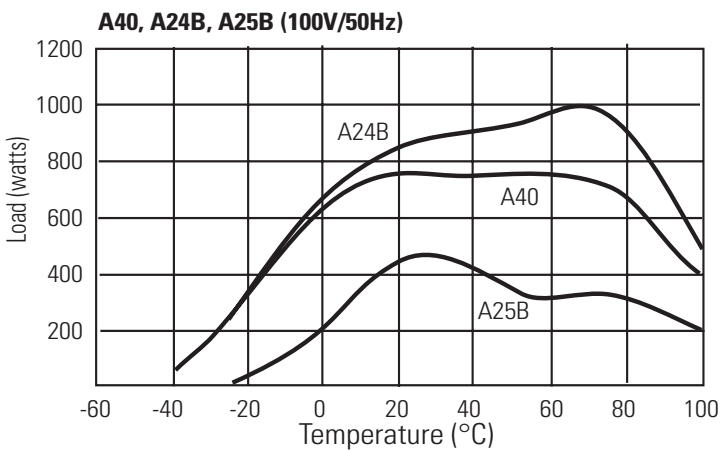
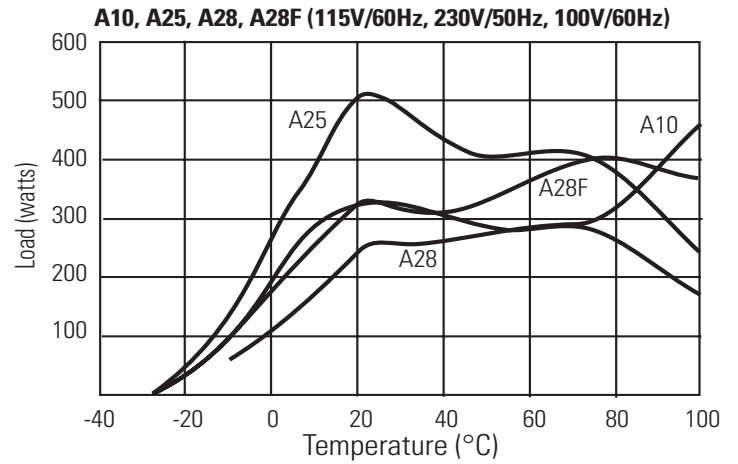
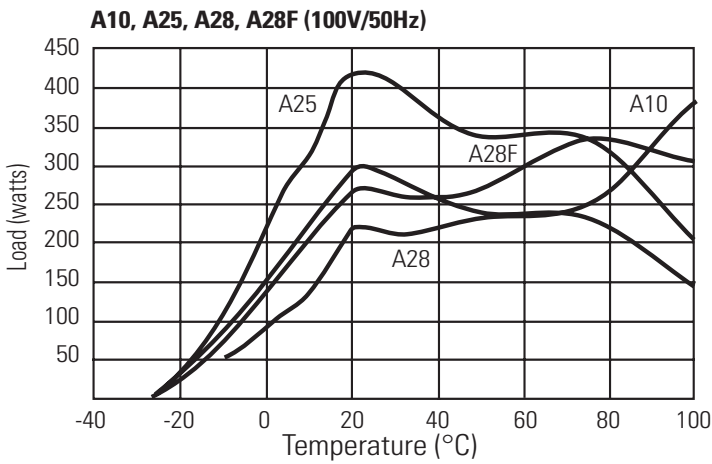
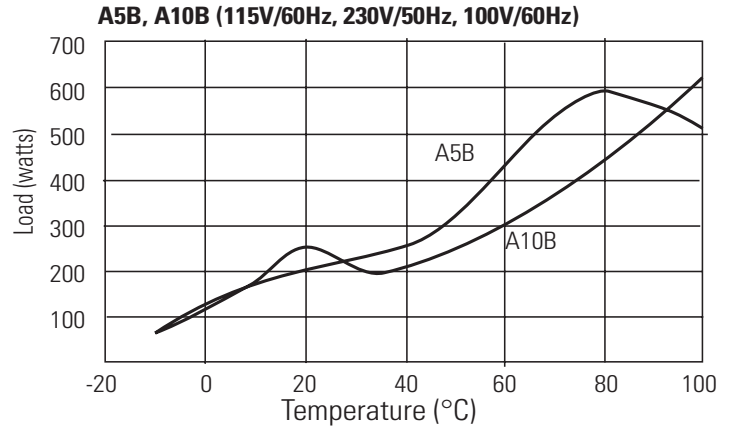
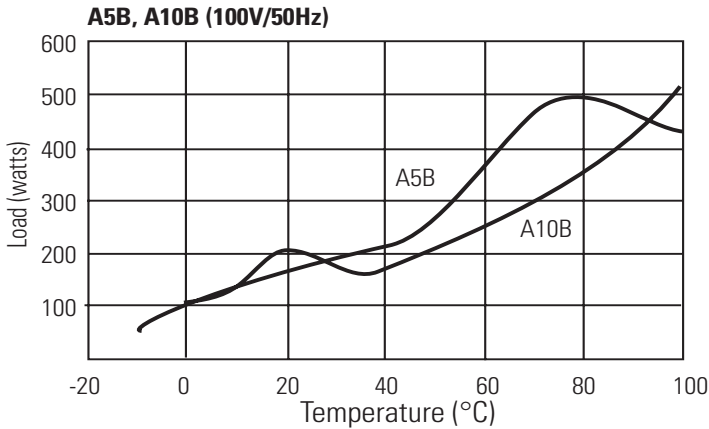

Specifications obtained at sea level using water (above +5°C to +90°C) or a fluid with a specific heat of 2.3 kJ/kg-K or 0.55 Btu/lb-F (less than 5°C) as the recirculating fluid at a +20°C ambient condition, at nominal operating voltage. Other fluids, process temperatures, ambient temperatures, altitude or operating voltage will affect performance. Pump specifications are nominal values of ±10%. Specifications are for reference only and are subject to change. Heat-up rates for the 100V baths will take approximately 25% longer than the 115V.

**Time to Temperature**

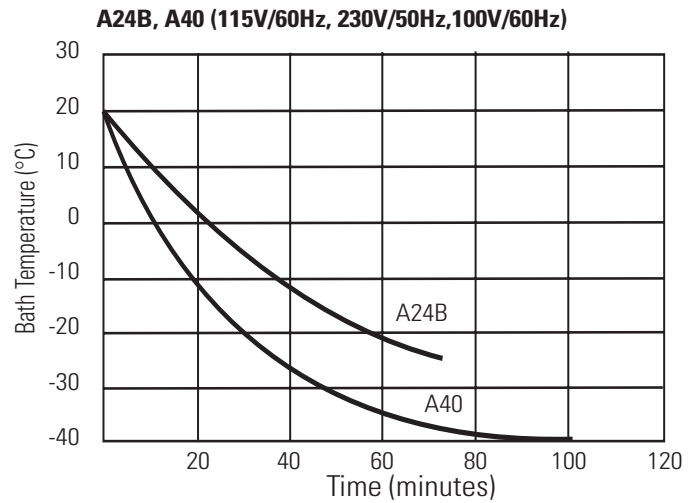
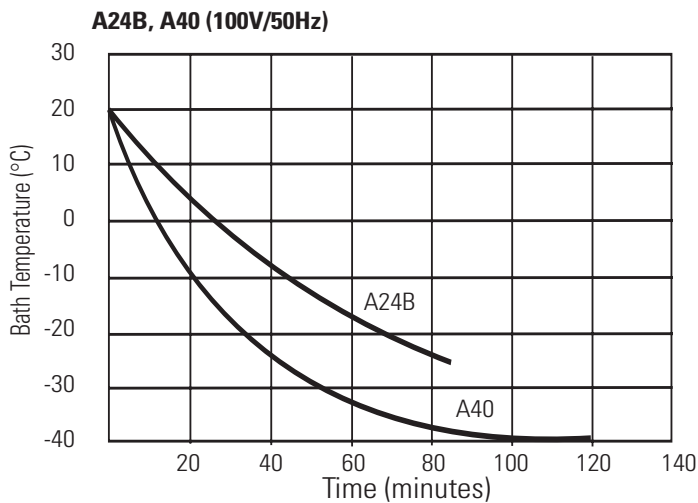
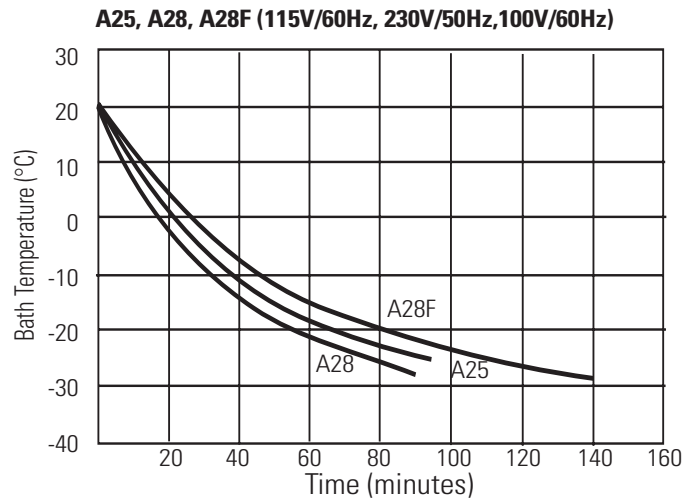
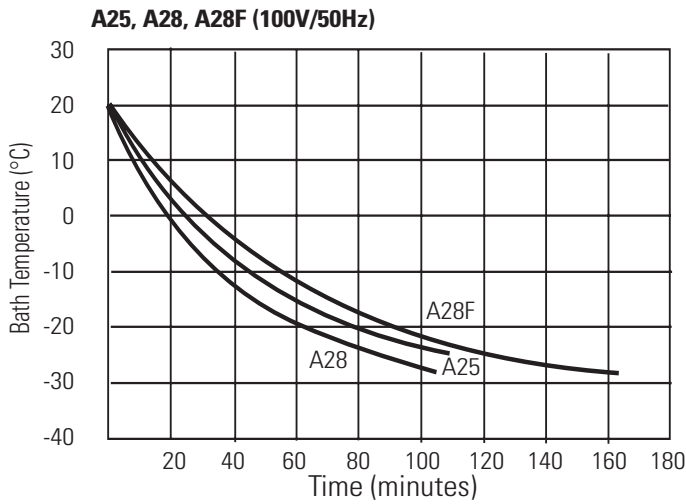
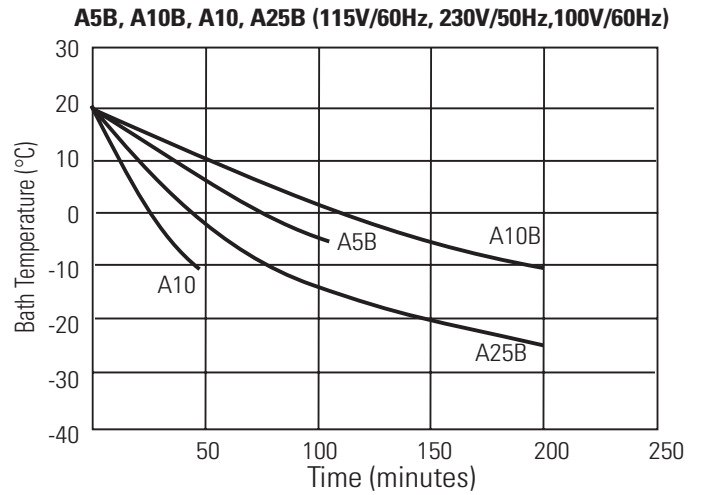
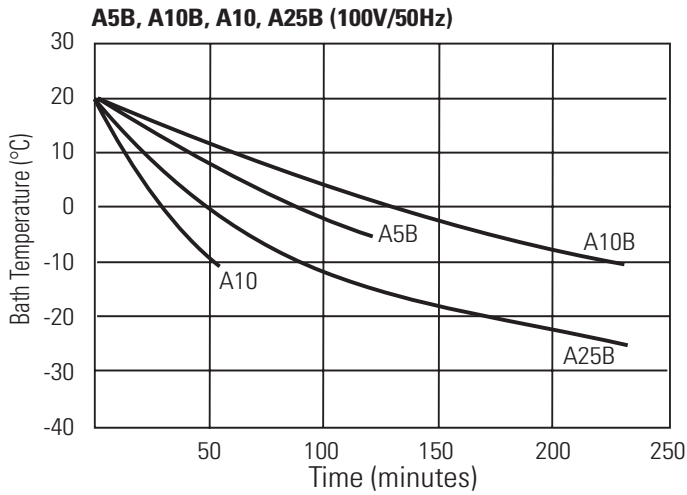

Specifications obtained at sea level using water (above +5°C to +90°C) or a fluid with a specific heat of 2.3 kJ/kg-K or 0.55 Btu/lb-F (less than 5°C) as the recirculating fluid at a +20°C ambient condition, at nominal operating voltage. Other fluids, process temperatures, ambient temperatures, altitude or operating voltage will affect performance. Pump specifications are nominal values of ±10%. Specifications are for reference only and are subject to change. Heat-up rates for the 100V baths will take approximately 25% longer than the 115V.



## SAHARA Heated Bath Circulator Specifications

Stainless Steel Bath Circulators				
	S3	S7	S13	S15
<b>SC100 Temperature Range</b> °C* °F*	Ambient +13 to 100 Ambient +23 to 212	Ambient +13 to 100 Ambient +23 to 212	Ambient +13 to 100 Ambient +23 to 212	Ambient +13 to 100 Ambient +23 to 212
<b>SC150/150L Temperature Range</b> °C* °F*	Ambient +13 to 150 Ambient +23 to 302	Ambient +13 to 150 Ambient +23 to 302	Ambient +13 to 150 Ambient +23 to 302	Ambient +13 to 150 Ambient +23 to 302
<b>Bath Volume</b> liters gallons	2 - 6 0.6 - 1.6	4 - 8 1.1 - 2.1	7 - 12 1.8 - 3.2	7 - 17 1.8 - 4.5
<b>Overall Dimensions**</b> (H x W x D) mm inches	406 x 235 x 428 16.0 x 9.2 x 16.7	456 x 235 x 428 18.0 x 9.2 x 16.7	456 x 321 x 428 18.0 x 12.6 x 16.7	456 x 381 x 457 18.0 x 15.0 x 18.0
<b>Work Area Dimensions</b> (D x W x L) mm inches	150 x 154 x 112 5.9 x 6.1 x 4.4	200 x 154 x 112 7.9 x 6.1 x 4.4	200 x 293 x 112 7.9 x 9.4 x 4.4	200 x 300 x 141 7.9 x 11.8 x 5.5
<b>Net Weight</b> kg/lb	9.8/21.5	10.6/23.4	12.3/27.0	13.7/30.1

Stainless Steel Bath Circulators				
	S21	S30	S45	S49
<b>SC100 Temperature Range</b> °C* °F*	Ambient +13 to 100 Ambient +23 to 212	Ambient +13 to 100 Ambient +23 to 212	Ambient +13 to 100 Ambient +23 to 212	Ambient +13 to 100 Ambient +23 to 212
<b>SC150/150L Temperature Range</b> °C* °F*	Ambient +13 to 150 Ambient +23 to 302	Ambient +13 to 150 Ambient +23 to 302	Ambient +13 to 150 Ambient +23 to 302	Ambient +13 to 150 Ambient +23 to 302
<b>Bath Volume</b> liters gallons	7 - 19 1.8 - 5.0	14 - 26 3.7 - 6.9	30 - 41 7.9 - 10.8	29 - 53 7.7 - 14.0
<b>Overall Dimensions**</b> (H x W x D) mm inches	409 x 381 x 628 16.1 x 15.0 x 24.7	456 x 381 x 628 18.0 x 15.0 x 24.7	556 x 381 x 628 21.9 x 15.0 x 24.7	456 x 579 x 746 18.0 x 22.8 x 29.4
<b>Work Area Dimensions</b> (D x W x L) mm inches	150 x 297 x 312 5.9 x 11.7 x 12.3	200 x 297 x 312 7.9 x 11.7 x 12.3	300 x 298 x 312 11.8 x 11.7 x 12.3	200 x 498 x 430 7.9 x 19.6 x 16.9
<b>Net Weight</b> kg/lb	14.2/31.2	16.5/36.2	20.3/44.7	24.3/53.4

\*Lower temperature range requires supplemental cooling.

\*\*Add ~26 mm (1 inch) to D for drain fitting.

\*\*\*See Section 3 for additional information.

- Thermo Fisher Scientific reserves the right to change specifications without notice.

**Time to Temperature**

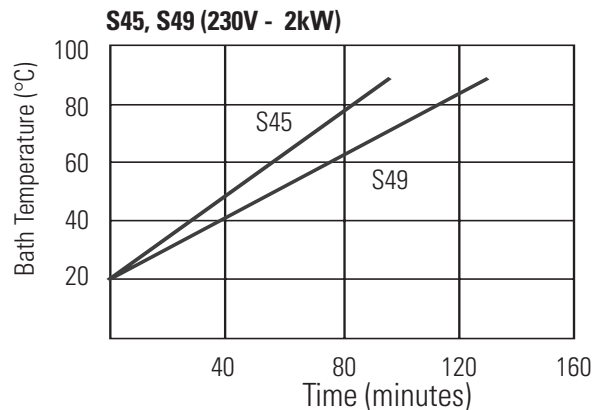
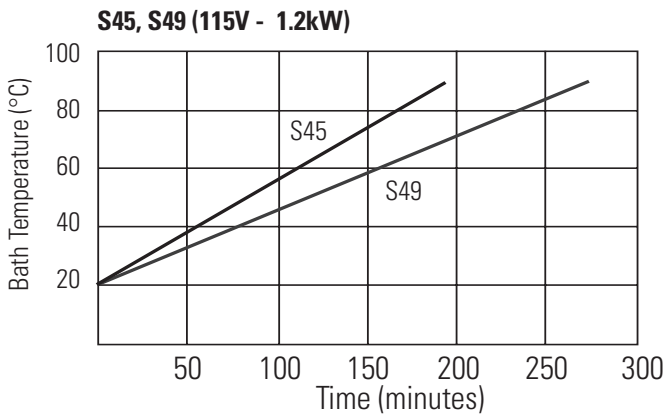
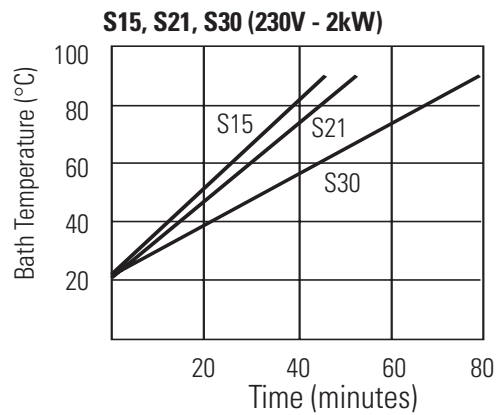
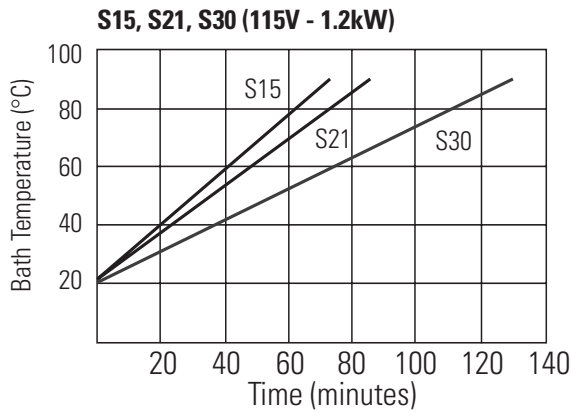
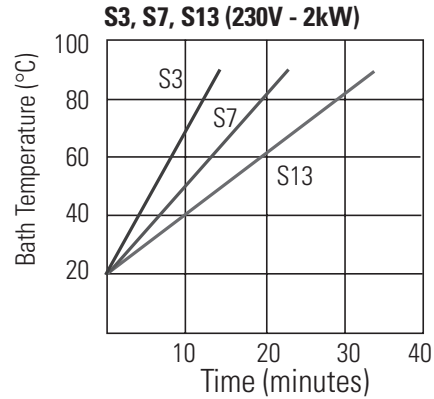
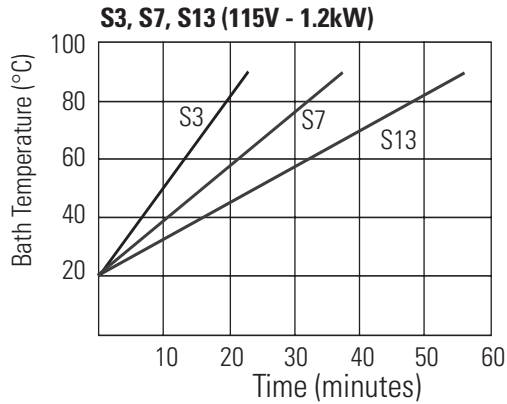

Specifications obtained at sea level using water (above +5°C to +90°C) or a fluid with a specific heat of 2.3 kJ/kg-K or 0.55 Btu/lb-F (less than 5°C) as the recirculating fluid at a +20°C ambient condition, at nominal operating voltage. Other fluids, process temperatures, ambient temperatures, altitude or operating voltage will affect performance. Pump specifications are nominal values of ±10%. Specifications are for reference only and are subject to change. Heat-up rates for the 100V baths will take approximately 25% longer than the 115V.



Transparent Acrylic Bath and Polyphenylene oxide (PPO) Bath Circulators are used with water only. ▲

Transparent Acrylic Bath Circulators			
	S6T	S12T	S19T
<b>Temperature Range</b> °C* °F*	Ambient +13 to 80 Ambient +23 to 176	Ambient +13 to 80 Ambient +23 to 176	Ambient +13 to 80 Ambient +23 to 176
<b>Bath Volume</b> liters gallons	4 - 6 1 - 1.6	8 - 12 2.1 - 3.2	12 - 19 3.2 - 5.0
<b>Overall Dimensions**</b> (H x W x D) mm inches	354 x 177 x 406 14.0 x 7.0 x 16.0	354 x 340 x 348** 14.0 x 13.4 x 13.7**	354 x 340 x 526** 14.0 x 13.4 x 20.7**
<b>Work Area Dimensions</b> (D x W x L) mm inches	150 x 138 x 223 5.9 x 5.4 x 8.8	150 x 302 x 149 5.9 x 11.9 x 5.9	150 x 302 x 327 5.9 x 11.9 x 12.9
<b>Net Weight</b> kg lb	6.7 14.8	8.2 18.1	9.7 21.4

Polyphenylene Oxide (PPO) Bath Circulators			
	S5P	S14P	S21P
<b>Temperature Range</b> °C* °F*	Ambient +13 to 100 Ambient +23 to 212	Ambient +13 to 100 Ambient +23 to 212	Ambient +13 to 100 Ambient +23 to 212
<b>Bath Volume</b> liters gallons	3 - 5 0.8 - 1.3	8 - 14 2.1 - 3.7	13 - 21 3.4 - 5.5
<b>Overall Dimensions</b> (H x W x D) mm inches	360 x 190 x 388 14.2 x 7.5 x 15.3	361 x 358 x 452 14.2 x 14.1 x 17.8	361 x 358 x 642 14.2 x 14.1 x 25.3
<b>Work Area Dimensions</b> (D x W x L) mm inches	160 x 132 x 132 6.3 x 5.2 x 5.2	160 x 300 x 163 6.3 x 11.8 x 6.4	160 x 300 x 353 6.3 x 11.8 x 13.9
<b>Net Weight</b> kg lb	5.1 11.2	6.3 13.9	6.6 14.5

\*Lower temperature ranges available with supplemental cooling.

\*\*Add ~13 mm (1/2 inch) to D for drain fitting.

- Thermo Fisher Scientific reserves the right to change specifications without notice.

**Wetted Materials**

**STANDARD Immersion Circulator**

Viton  
EPDM  
Ryton  
Ultem  
Vectra  
Stainless Steel

**Stainless Steel Baths/Circulators**

Stainless Steel 316  
Stainless Steel 304  
EPDM (drain fitting)  
Ryton  
Zotek-N (cover seal)

**Transparent Acrylic Baths/Circulators**

Poly-acryl

**Polyphenylene oxide (PPO) Baths/Circulators**

Polyphenylenoxid

## Section 3 Installation

### Ambient Conditions

Ambient Temperature Range	5°C to 40°C (41°F to 104°F)
Maximum Relative Humidity	80% at 31°C (88°F)
Operating Altitude	Sea Level to 2000 meters (6560 feet)
Overvoltage Category	II
Pollution Degree	2
Degree of Protection	IP 20

---

### Immersion Circulator Only



The immersion circulator is designed for continuous operation and for indoor use.

Never place the immersion circulator in a location where excessive heat, moisture, inadequate ventilation, or corrosive materials are present. ▲



Carefully install the immersion circulator to ensure it does not fall into the container or that its line cord does not make contact with the container contents.

For immersion circulators equipped with a clamp:

- Attach and secure the clamp to your container.
- The maximum wall thickness is 25 mm (~1").
- The immersion depth is 75 to 145 mm (~3 to 5 <sup>3</sup>/<sub>4</sub> ").
- Your container must be sturdy enough to support the weight of the assembly, approximately 3.8 kilograms (8.5 pounds).

## Bath Circulator

The circulator is designed for continuous operation and for indoor use.

The equipment normally ships with circulator mounted facing the reservoir. You may change the position  $\pm 90^\circ$  by removing thumb screws, no tools are required.



**Do not mount it backwards; the line cord could contact the reservoir fluid. ▲**

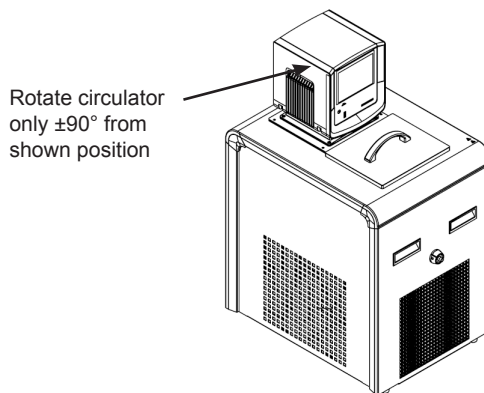

The nozzle at the end of the pump can be repositioned for maximum flow in the bath. When repositioning the circulator ensure the nozzle is not directed towards a bath wall. There is a second opening on the pump that is capped, do not remove this cap.



**Never place the circulator in a location where excessive heat, moisture, inadequate ventilation, or corrosive materials are present. ▲**



**Leave refrigerated baths in an upright position at room temperature ( $\sim 25^\circ\text{C}$ ) for 24 hours before starting. This will ensure the lubrication oil has drained back into the compressor. ▲**

## Ventilation

The circulator can operate with 0 clearance on two exhaust sides as long as the third exhaust side has unrestricted air flow. Blocked ventilation will increase the circulator's temperature, reduce its cooling capacity and, on refrigerated baths, eventually lead to premature compressor failure.

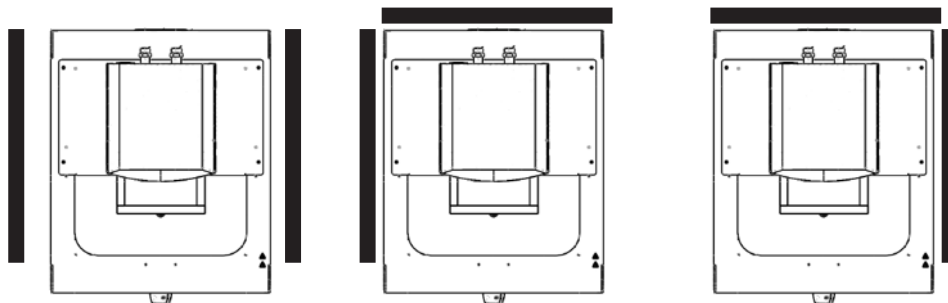

Ventilation Options

## Electrical Requirements



The circulator's construction provides protection against the risk of electrical shock by grounding appropriate metal parts. The protection will not function unless the power cord is connected to a properly grounded outlet. It is the user's responsibility to assure a proper ground connection is provided. ▲

The circulator is intended for use on a dedicated outlet. All circulator are equipped with automatic thermally-triggered 20 Amp circuit protector.

The circuit protector is designed to protect the circulator.

**Note** If the circuit protector activates allow the circulator to cool before resetting. Restart the circulator. Contact us if it activates again. ▲



The circulator's power cord is used as the disconnecting device, it must be easily accessible at all times. ▲



Operate the circulator using only the supplied line cords, never operate equipment with damaged cords. ▲

Refer to the bath nameplate on the rear, upper-left-hand corner of the bath for specific electrical requirements. Voltage deviations of  $\pm 10\%$  are permissible. The outlet must be rated as suitable for the total power consumption of the circulator, see next page.

**Note** If a bath and immersion circulator were purchased separately, follow the electrical requirements listed on the bath nameplate. ▲

The following power options are available:

Bath	Volts <sup>1</sup> /Hertz/Phase	Amps <sup>2</sup>	Total Wattage	Plug Type
<b>A10</b>	115/60/1	11.5	1165	N5-15
	100/50-60/1	11.4	1120	N5-15
	230/50/1	10.3	2370	Country Specific
<b>A28/A25</b>	115/60/1	11.7	1185	N5-15
	100/50-60/1	11.5	1135	N5-15
	230/50/1	10.4	2395	Country Specific
<b>A5B/A10B</b>	115/60/1	11.5	1165	N5-15
	100/50-60/1	11.4	1120	N5-15
	230/50/1	10.3	2370	Country Specific
<b>A25B</b>	115/60/1	11.7	1185	N5-15
	100/50-60/1	11.5	1135	N5-15
	230/50/1	10.4	2395	Country Specific
<b>A28F</b>	115/60/1	11.5	1165	N5-15
	100/50-60/1	11.4	1120	N5-15
	230/50/1	10.3	2370	Country Specific
<b>A40/A24B</b>	115/60/1	14.4	1660	N5-20
	100/50-60/1	15.3	1525	N5-20
	230/50/1	11.3	2600	Country Specific
<b>All Heated Baths/Circulators</b>	115/60/1	11.3	1300	N5-15
	100/50-60/1	10.0	1300	N5-15
	230/50/1	9.3	2135	Country Specific

- 1. Volts ± 10%
- 2. Maximum amp draw

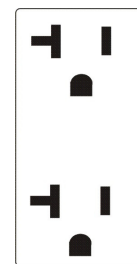

20 Amp Outlet  
(16 Amp)

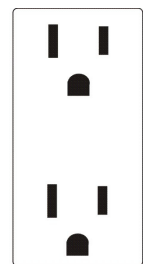

15 Amp Outlet  
(12 Amp)



**For refrigerated baths:**



Ensure all communication and electrical connections are made prior to starting the circulator. ▲

- Install the supplied RJ45 shielded cable between the immersion circulator and the bath RJ45 connectors (similar to Ethernet). **This is required for proper operation.**

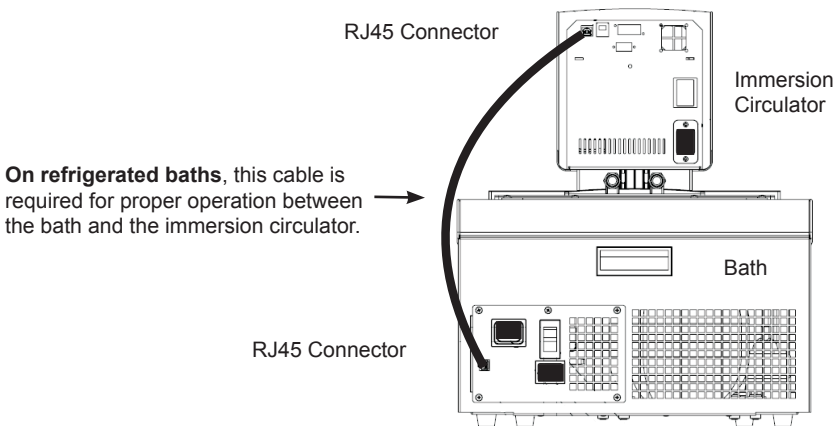

- Install the power cord from the connector on the rear of the circulator, A, to the connector on the rear of the refrigerated bath, B.
- Connect the bath's power cord, C, to a grounded power outlet.



For refrigerated baths, never connect controller power inlet, A, to a power outlet. Never connect power outlet, B, to anything but an immersion circulator. ▲



Ensure the electrical cords do not come in contact with any of the plumbing connections or tubing. ▲

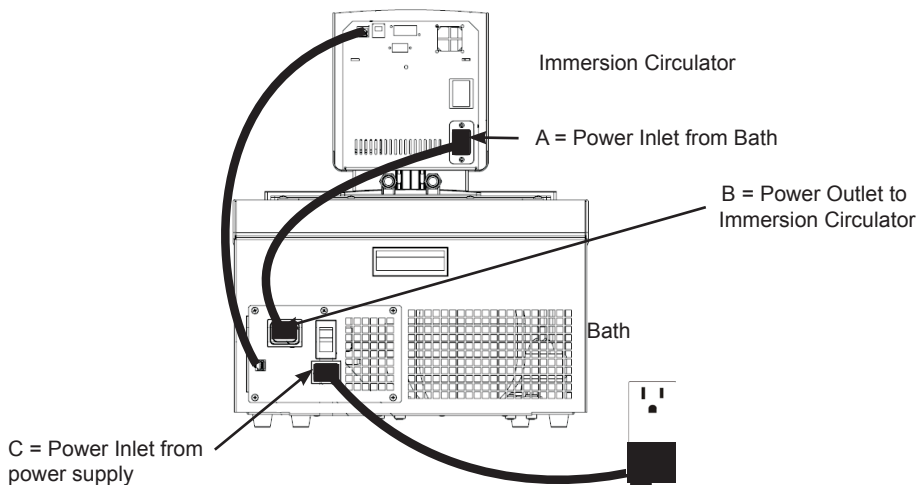

**For non-refrigerated baths:**



- Connect the bath's power cord, C, to a grounded power outlet.

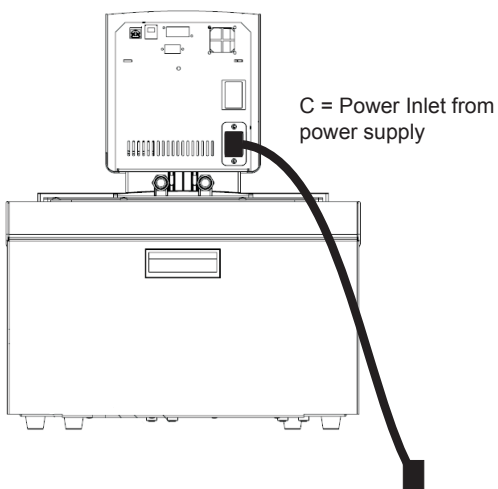

**Ensure the electrical cords do not come in contact with any of the plumbing connections or tubing. ▲**



## External Circulation

The plumbing connections for external circulation are located on the rear of the circulator.  is the return flow from the external application.  is the outlet flow to the external application (supply side). The connections are 16 mm O.D. Remove the union nuts and plates to install the 8 mm or 12 mm hose barbs and clamps supplied with the circulator.

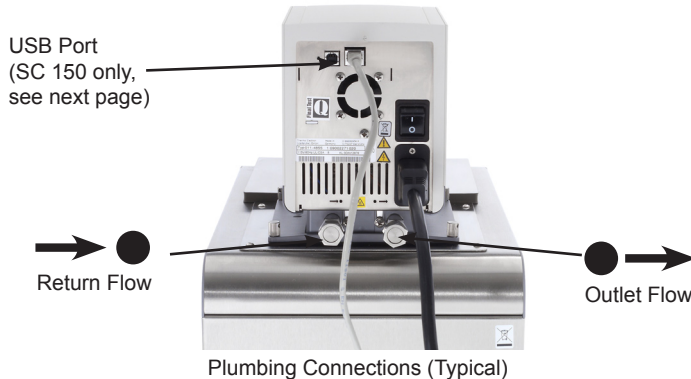

**Note** Cap the pump nozzle with the supplied fitting for maximum pressure to the external application, it may be necessary to remove the circulator from the bath to access the nozzle. ▲

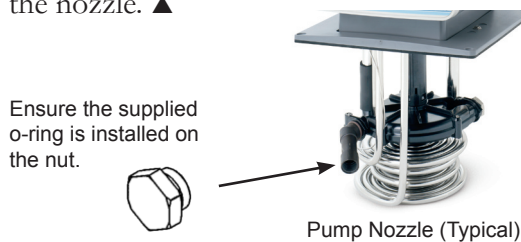

**Note** There is a second opening on the pump that is capped, do not remove this cap or fluid will overflow the reservoir. ▲

When using the internal bath only, the plumbing connections can be closed with the supplied plate and union nuts.



**To prevent damage to the circulator's plumbing, use a 19 mm backing wrench when removing/installing the external connections. ▲**



## USB Port (SC 150 only)

## Tubing Requirements



If your computer does not automatically recognize the USB driver, installation instructions are provided in the Appendix.

Tubing is normally used to connect the pump to an external application.

**Ensure none of the tubing comes in contact with the power cord. ▲**

**Note** The maximum allowable length of tube depends largely on the size, form and material of the external reservoir. The length of tube and its diameter, combined with the circulating capacity, have a large affect on the temperature stability. Whenever possible, use a wider tube diameter and place the application as close as possible to the circulator. ▲



**Extreme operating temperatures will lead to extreme temperatures on the tube surface, this is even more critical with metal nozzles. ▲**

- the required tube material depends on the heat transfer liquid used
- tubes must not be folded or bent
- after prolonged use, tubes may become brittle or they may get very soft, check them on a regular basis and replace if necessary
- secure all tube connections using clamps

## Tubing

Tubing for Thermo Scientific temperature control systems is optional. Tubing is available in lengths of 0.5, 1.0 and 1.5 meters. Couplings for connecting tubes are also available. The smallest opening inside the metal tubes is 10 mm. The metal tubing is provided with coupling nuts (M16 x 1, DIN 12 879, part 2) at either end.

Please select the proper tubing from the table shown in Section 5.



**Ensure the tubing you select will meet your maximum temperature and pressure requirements. ▲**

### Plastic and rubber tubing

If other plastic and rubber tubes are used, ensure that the tubes selected are fully suitable for the particular application, i.e., that they will not split, crack or become disengaged from their connections.

Connect the tubing using the supplied tube fittings for 8 or 12 mm i.d. They are attached to the plumbing connections with a supplied coupling nut.

We highly recommend using foam rubber insulation on the tubing and the fittings.

### Metal tubing

Thermo Scientific metal tubing (stainless steel insulated) offers a particularly high degree of safety and is suitable for both low and high temperatures/liquids.

The metal tubing is attached directly to the plumbing connections, gaskets are not required.



**Do not subject tubing to mechanical strain and ensure any specified bend radius is not exceeded. ▲**

## Approved Fluids



Only use the approved fluids listed below. ▲

All immersion circulators:

Water

Ethylene Glycol-Water

Propylene Glycol-Water

SC 150 and SC 150L immersion circulators only:

SIL 100

SIL 180

SIL 300

SYNTH 60

SYNTH 260

Thermo Fisher Scientific takes no responsibility for damages caused by the selection of an unapproved bath fluid.



Other than water, handle and dispose of approved liquids in accordance with the fluid manufacturer's specification and/or the fluid's MSDS. ▲



To set the fluid temperature alarms, use the circulator's menu selection to identify the fluid, see Section 4. ▲



When using water above 80°C closely monitor the fluid level, frequent top-offs will be required. It will also create steam. ▲



Water/glycol mixtures require top-offs with pure water, otherwise the percentage of glycol will increase resulting in high viscosity and poor performance. ▲



Transparent Acrylic Bath and Polyphenylene oxide (PPO) Bath Circulators are used with water only. ▲

### Fire point

Flammable thermal liquids can ignite when a specified temperature is surpassed. The fluid is limited to a temperature level 25°C below the fire point as defined by the EN 61010.

### Viscosity

For optimum temperature accuracy, it is important that heat transfer liquids have a low viscosity.

#### ■ Working temperature range

This is the recommended long-term operating range. The maximum viscosity is approximately 5 mPas.

#### □ Operating temperature range

Long-term operation is recommended only under certain conditions. The viscosity may rise to a maximum of 30 mPas. The pump capacity will not match specifications.

#### ■ Heating-up range

Long-term operation is not recommended, the pump motor's excess temperature protection may switch off the pump.

Range of Application	Sil 100	Sil 180	Sil 300	Synth 60	Synth 260
Fire Point °C	>100	>225	>325	70	275
Flash Point °C	57	170	300	59	260
Viscosity at 20°C (mPas)	3	11	200	2	140
Density at 20°C (kg/dm <sup>3</sup> )	0.89	0.93	1.08	0.76	1.03
Specific heat capacity (kJ/Kg*K)	1.67	1.51	1.56	2.10	2.00

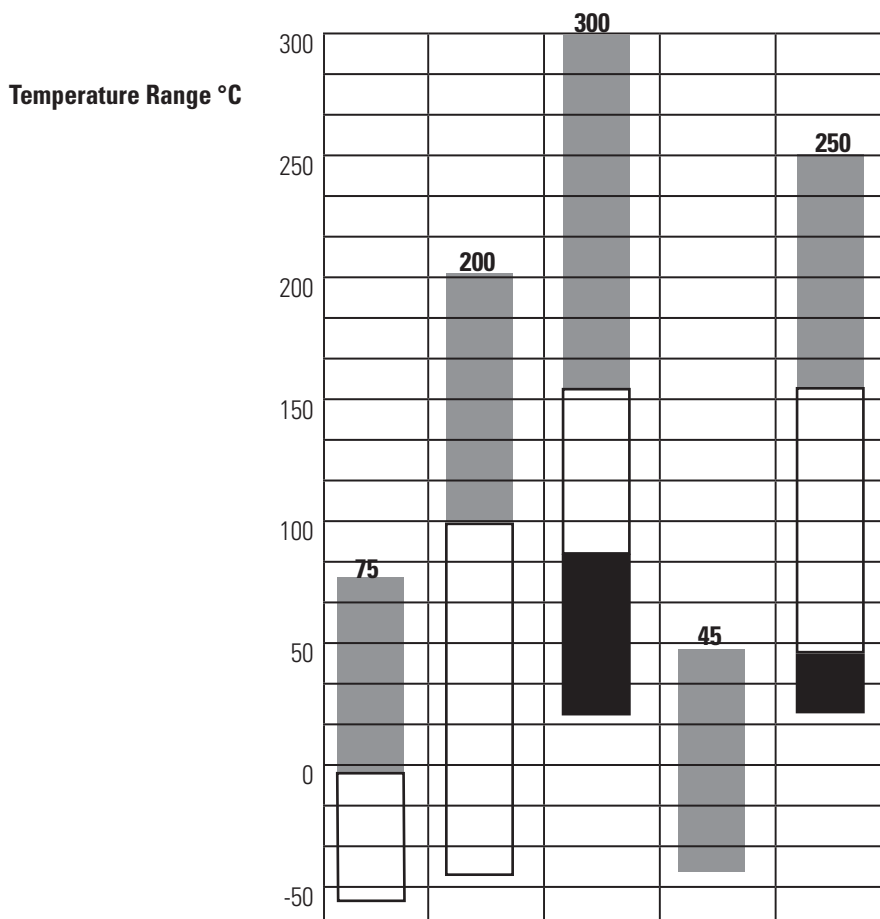

Order Number 10 liter container	999-0202	999-0204	999-0206	999-0210	999-0214
Order Number 5 liter container	999-0201	999-0203	999-0205	999-0209	999-0213
Color	trans- parent, colorless	trans- parent, colorless	trans- parent, colorless	trans- parent, colorless	trans- parent, yellow
Reacts with	Silicone	Silicone	Silicone	Rubber Silicone	Copper Light metals Bronze

EC-Safety Data Sheets will be delivered together with each container of liquid.

### **Chlorine**

Short term usage of tap water may not cause any adverse effects on the circulator or your application, but in the long term problems may arise. To help alleviate these problems Thermo Fisher Scientific recommends the use of chlorine.

The duration of time that chlorine remains in solution depends on factors such as water temperature, pH and availability of direct sunlight. We recommend maintaining chlorine levels at proper levels using chlorine test strips, generally 1 to 5 ppm is adequate.

For best results, the pH of the fluid should be maintained between 6.5 and 7.5. Additional chlorine should not be added without first determining the concentration ratio that already exists in the fluid supply. Corrosion and degradation of the circulation components can result from concentration ratios that are too high. Contact our customer support for additional information.

### **5°C to 95°C — Distilled Water or Deionized Water (up to 3 MΩ-cm)**

Normal tap water leads to calcareous deposits necessitating frequent circulator decalcification, see table on page 3-14.

Calcium tends to deposit itself on the heating element. The heating capacity is reduced and service life shortened.

### **-30°C to 80°C — Water with Glycol**

Below 5°C water has to be mixed with a glycol. The amount of glycol added should cover a temperature range 5°C lower than the operating temperature of the particular application. This will prevent the water/glycol from gelling (freezing) near the evaporating coil.

Excess glycol deteriorates the temperature accuracy due to its high viscosity.

### **-40°C to 200°C — SIL180 (SC 150 and SC 150L circulators only)**

SIL180 is suitable for covering nearly the entire range with just one liquid, especially when used with the cooling units.

Unfortunately SIL180 has a wetting tendency necessitating the occasional cleaning of the bath cover.

### **other temperatures (SC 150 and SC 150L circulators only)**

Thermo Fisher Scientific offers a range of heat transfer fluids for these temperature control applications.

### **SYNTH 60 and SYNTH 260: (SC 150 and SC 150L circulators only)**

Synthetic thermal liquid with a medium life span (several months) and little smell annoyance.



**SIL 100, SIL 180, SIL 300: (SC 150 and SC 150L circulators only)**

Silicone oil with a very long life span ( over 1 year) and negligible smell.

Thermo Fisher heat transfer fluids are supplied with an EC Safety Data Sheet.



**Ensure, when selecting the heat transfer fluid, that no toxic gases can be generated. Inflammable gases can build up over the fluid during usage. ▲**



**Ensure the over temperature cut-off point is set lower than the fire point for the heat transfer fluid selected. ▲**



**The highest working temperature, as defined by the EN 61010 (IEC 1010), must be limited to 25°C below the fire point of the fluid. ▲**

## **Additional Fluid Precautions**

When working with fluids other than water:

- Do not use any approved fluid until you have read and understood the label and the Material Safety Data Sheet (MSDS).
- Ensure any fluid residue or any other material is thoroughly removed before filling the bath with a different fluid.
- Always wear protective clothing, especially a face shield and gloves.
- Avoid spattering on any of the circulator's components, always *slowly* add fluid. When adding, point the opening of a container away from yourself.
- Use fume hoods.
- Do not allow any ignition sources in the vicinity.

## Water Quality and Standards

Process Fluid	Permissible (PPM)	Desirable (PPM)
<b>Microbiologicals</b>		
(algae, bacteria, fungi)	0	0
<b>Inorganic Chemicals</b>		
Calcium	<25	<0.6
Chloride	<25	<10
Copper	<1.3	<1.0
Iron	0.020 ppm if fluid in contact with aluminum <0.3	<0.1
Lead	<0.015	0
Magnesium	<12	<0.1
Manganese	<0.05	<0.03
Nitrates\Nitrites	<10 as N	0
Potassium	<20	<0.3
Silicate	<25	<1.0
Sodium	<20	<0.3
Sulfate	<25	<1
Hardness	<17	<0.05
Total Dissolved Solids	<50	<10
<b>Other Parameters</b>		
pH	6.5-8.5	7-8
Resistivity	0.01*	0.05-0.1*

\* MΩ-cm (compensated to 25°C)

Unfavorably high total ionized solids (TIS) can accelerate the rate of galvanic corrosion. These contaminants can function as electrolytes which increase the potential for galvanic cell corrosion and lead to localized corrosion such as pitting. Eventually, the pitting will become so extensive that refrigerant will leak into the water reservoir.

As an example, raw water in the United States averages 171 ppm (of NaCl). The recommended level for use in a water system is between 0.5 to 5.0 ppm (of NaCl).

Recommendation: Initially fill the reservoir with distilled or deionized water. Do not use untreated tap water as the total ionized solids level may be too high. This will reduce the electrolytic potential of the water and prevent or reduce the galvanic corrosion observed.

## Filling Requirements

Ensure the reservoir drain port on the front of the bath is *closed* and that all plumbing connections are secure. Also ensure any residue is thoroughly removed before filling the reservoir.



**Before using any fluid refer to the manufacturer's MSDS and EC safety data sheets for handling precautions. ▲**

To avoid spilling, place your containers into the reservoir before filling.

With a low level WARNING the circulator continues to run, with a FAULT the circulator will shut the refrigeration, pump and heater will shut down, see Section 7. The low level warning for the SC 150 is at approximately 47 mm (1 7/8") below the top, the low level fault is at approximately 60mm (2 3/8"). The SC150L is 45 mm (1 3/4") lower for both levels.



**Avoid overfilling, oil-based fluids expand when heated. ▲**

When pumping to an external system, keep extra fluid on hand to maintain the proper level in the circulating lines and the external system.

**Note** Monitor the fluid level whenever heating the fluid. ▲

## Draining



**Before draining any fluid refer to the manufacturer's MSDS and EC safety data sheets for handling precautions. ▲**



**Ensure the fluid is at a safe handling temperature, ~55°C. Wear protective clothing and gloves. ▲**

- place a suitable container underneath the drain. If desired, attach an 8 mm id tube on the drain.
- *slowly* turn the drain plug until flow is observed.



**Turning the drain cap more than 1 1/2 turns will result in the drain cap and fitting coming off. ▲**

In this case, the drain fitting can be screwed back on. Attaching the cap onto the fitting will aid in installation. If required, contact us for additional information.

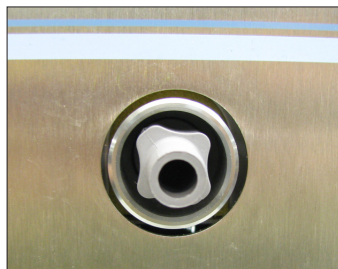

Installed Drain Fitting with Cap Removed



## Section 4 Operation

### STANDARD Immersion Circulator

The Thermo Scientific STANDARD Series of immersion circulators have a digital display and easy-to-use touch pad, five programmable setpoint temperatures, acoustic and optical alarms. Circulators offer adjustable high temperature protection.

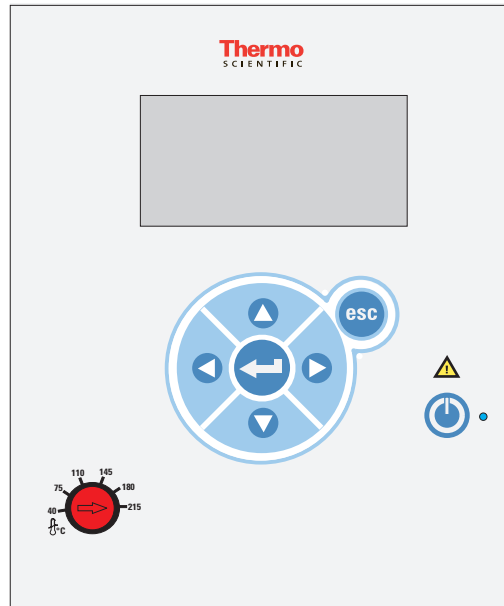

This label indicates read the instruction manual before starting the circulator.



Use this button to place the circulator in and out of stand by, see page 4-3 for more details. The blue LED illuminates when stand by is enabled.



Use these navigation arrows to move through the circulator displays and to adjust values.



Pressing this button once to make changes on the immersion circulator's display screen. In most cases, pressing it again is required to save the change.



Use this button to cancel any changes and to return the circulator to its previous display. Canceling a change can only be made before the change is saved. In some cases, it is also used to save changes.

**Note** Holding this button for five seconds resets the display contrast to the default level and also brings up the language menu to change, if needed, the displayed language. See **Settings-Display Options** in this Section. ▲



Used for adjusting and resetting the High Temperature Cutout. Details are explained in this Section.

## Setup



Leave refrigerated baths in an upright position at room temperature (~25°C) for 24 hours before starting. This ensures the lubrication oil has drained back into the compressor. ▲

Before starting, double check all the USB (optional), electrical and plumbing connections. ▲

## Start Up

Do not run the circulator until fluid is added to the reservoir. Have extra fluid on hand. If the circulator does not start refer to Section 5 Troubleshooting.

- For refrigerated baths, place the circuit protector located on the rear of the bath to the **I** position.
- Place the circuit protector located on the back of the immersion circulator to the **I** position.



After a slight delay the blue LED on the front panel illuminates.

- Press , the Start Display appears. The blue LED goes out.
- Ensure the start symbol has a highlight box around it, if not use the arrow keys to navigate to the symbol.

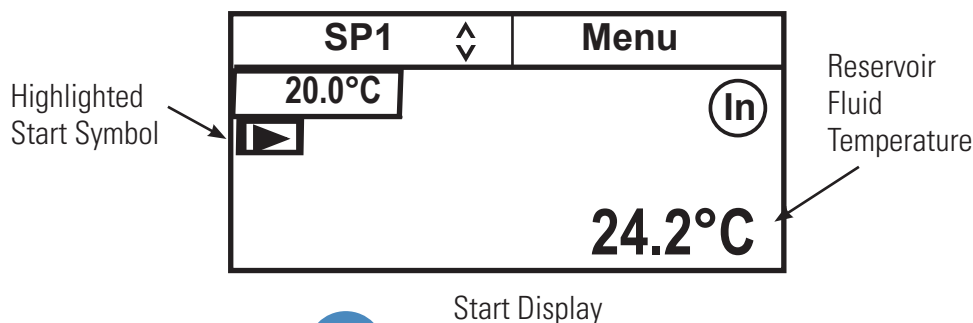

- Press . The circulator starts and the start symbol turns into a stop symbol (■).



**Note** The pump starts immediately but refrigerated baths take up to 30 seconds before the compressor starts. ▲

**Note** After start up, check all the plumbing connections for leaks. ▲

The **SP1** and **Menu** portions on the top of the display are used to view and/or change the circulator's settings. They are explained in detail later in this Section.

 indicates the circulator is using its internal sensor for temperature control.

## Status Display

If desired, press  to toggle between the Start/Status Displays.

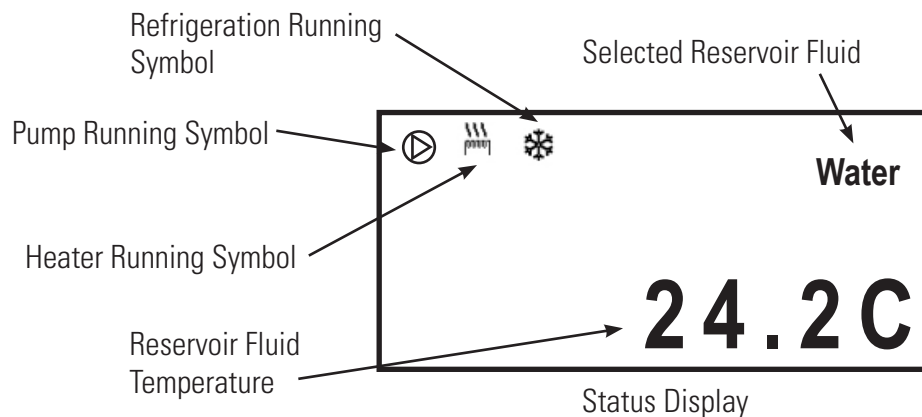



**Note** After 60 seconds, if no operator inputs are made the circulator automatically switches to the Status Display. If desired, change the time or disable this feature using the **Display Options** Menu. ▲

## Stand By Mode

Press , the circulator display goes blank and enters the stand by mode. The blue LED on the front panel illuminates.

## Stopping the Circulator

Ensure the stop symbol is highlighted, if not use the arrow keys to navigate to the symbol.

Press . The circulator stops and the stop symbol turns into a start symbol ().

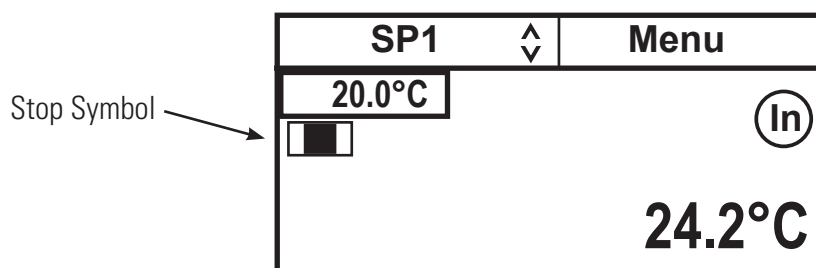





## Power Down

Press  , the circulator display goes blank and enters the stand by mode.

## Shut Down

Place the circuit protector on the back of the circulator to the  position. The blue LED will extinguish.

On refrigerated baths, place the circuit protector on the rear of the bath to the  position.



Using any other means to shut down a refrigerated bath can reduce the life of the compressor. ▲



Always turn the circulator off and disconnect it from its supply voltage before moving it. ▲



The circuit protector located on the rear of the components is not intended to act as a disconnecting means. ▲

## Restarting

**Note** When quickly restarting, the compressor may take up to 10 minutes before it starts to operate. ▲

## Changing the Setpoint

**Note** You can not adjust the setpoint closer than 0.1°C to either of the fluid's system limits, see Fluids Type in this Section, or beyond the bath's temperature range. ▲

The setpoint can be changed with the circulator running or not.

The Setpoint is the desired fluid temperature. The circulator can store up to five setpoints, **SP1** through **SP5**. The procedure for changing stored setpoint values is discussed later in this Section.

Use the navigation arrows and move to the setpoint window and then press  to highlight it and the setpoint value as shown below.

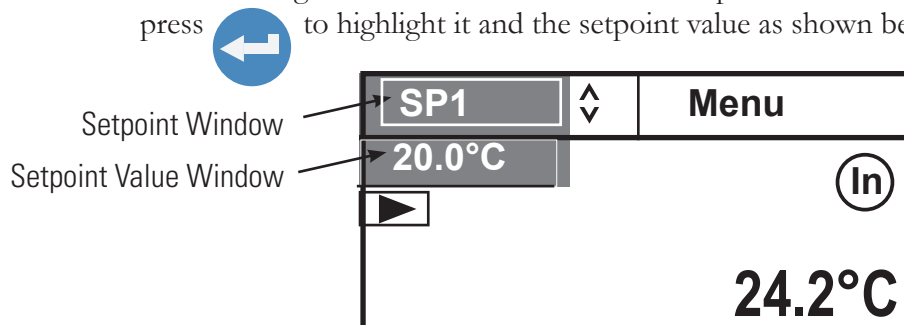

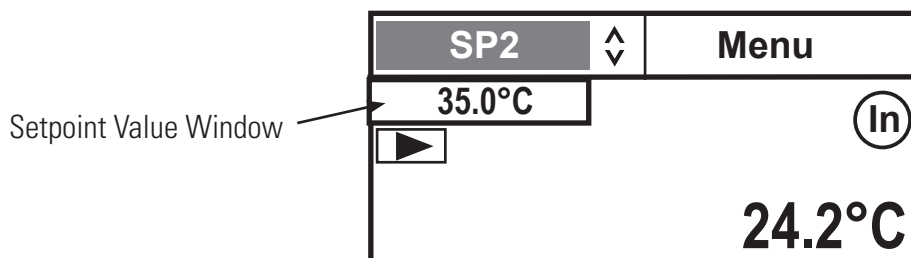

Use the up and down navigation arrows to bring up the desired setpoint, **SP1** through **SP5**, and then press .

The Setpoint Value Window now indicates the corresponding setpoint's stored value.

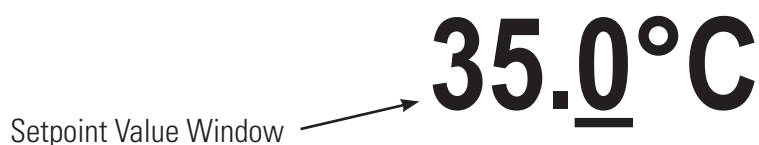

If desired, you can change the displayed setpoint value by using the navigation arrows to highlight the Setpoint Value Window and then pressing . The right-most digit will have a cursor beneath it.





Use the left and right arrows to move the cursor to the desired digit and then use the up and down arrows to change the value. Once all the desired changes are made, press  to save the change.

**Note** Using this procedure also changes the setpoint's stored value. ▲

## Menu Displays

The circulator uses menus to view/change its settings.

**Note** The circulator does not need to be running to view/change these settings. ▲

For all **Menu** displays, once  is pressed to change a display, you can press  to return to the previous screen.

1. Use the arrow buttons to highlight **Menu** and the circulator brings up the Main Menu Display.

SP1	▲ ▼	Menu
Settings		▲
System		▼

Main Menu Display

2. Use the up and down arrow to highlight the desired setting and then press  to bring up additional submenus.

Application Settings	▲
Display Options	
Menu	▼

See page 4-8.

SP1	▲ ▼	Menu
Settings		▲
System		▼

Messages	▲
Run Time	
Configuration	
Password/Reset	▼
Menu	

See page 4-13.

## Menu

The **Menu** line, at the bottom of all the submenu displays, is another way to return the circulator back to the Start Display.

1. From any submenu display, use the down arrow button to highlight **Menu**.

2. Press  to return to the Start Display.

Application Settings	▲
Display Options	
Menu	▼

SP1	▲ ▼	Menu
20.0°C		In
▶		24.2°C

Pressing  from the Menu line returns you to the previous screen. ▲

# Menu Tree

Since the circulator can only display five lines of text at a time, keep pressing the down arrow to view any additional options.

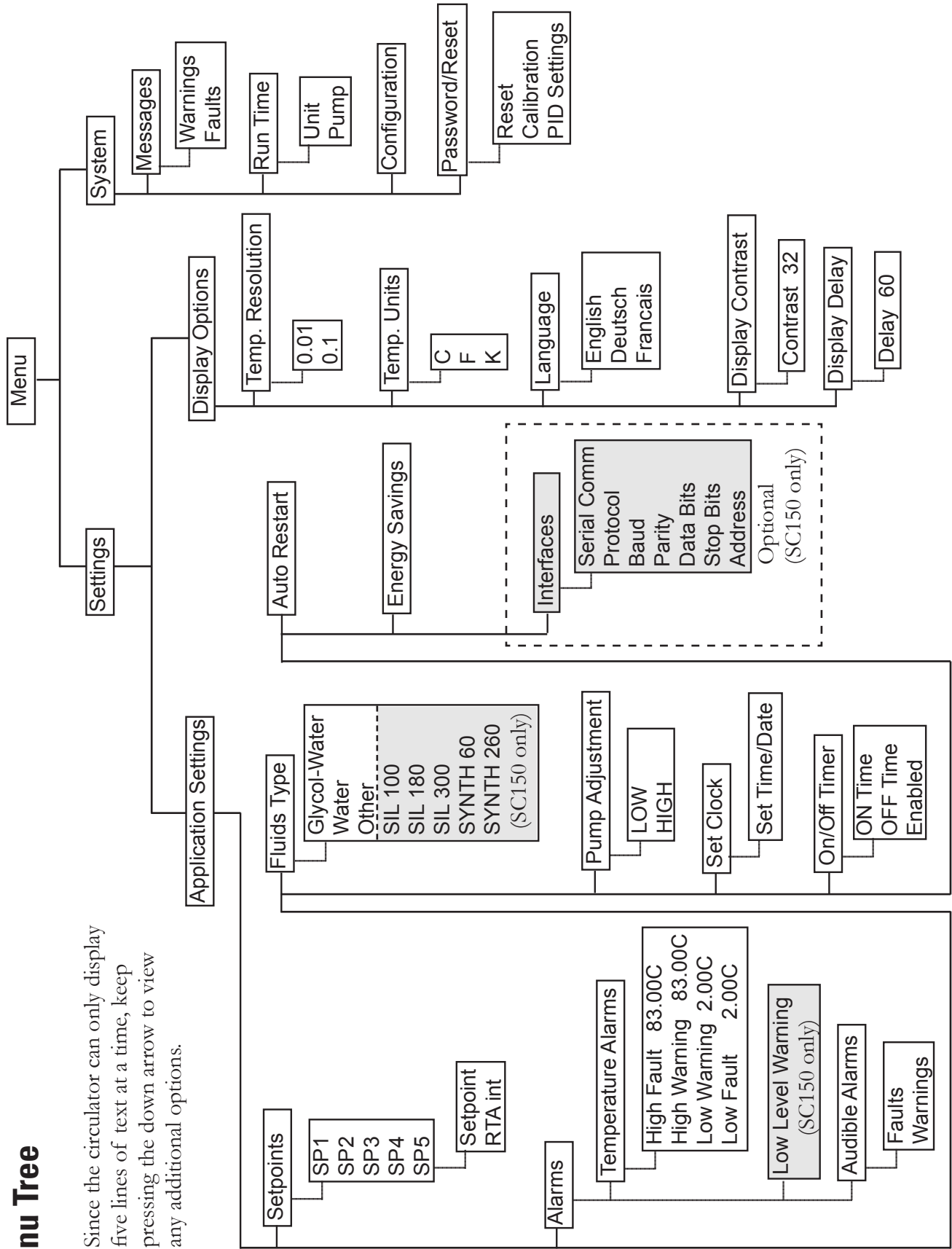

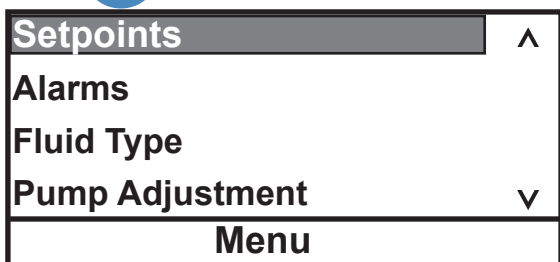

**Settings - Application Settings** is used to view/adjust the circulator's five Setpoints (**SP**) and Real Temperature Adjustments (**RTA**), enable/disable the alarms, change the fluid type, set the pump speed, configure the interface (optional), set the clock, turn the timer on or off, and turn auto restart and energy savings on or off.

1. With **Application Settings** highlighted press  to view:

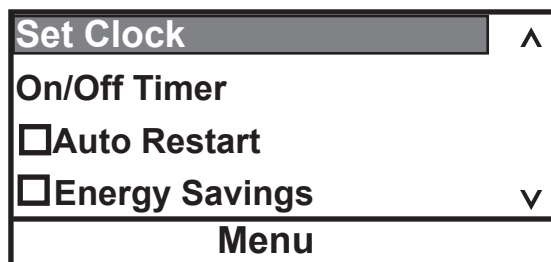

2. Scroll down for additional options:



3. With **Setpoints** highlighted, press  to display the list. Use the up/down arrows to highlight the desired **SP**. **Note** Use the down arrow to display **SP5**. ▲

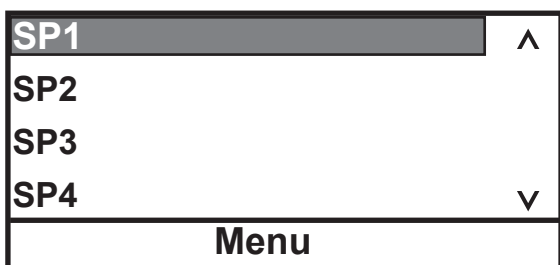

4. Press .

The **SP** and **RTA** are changed using the same procedure. With the desired setpoint highlighted press  to display the submenu.

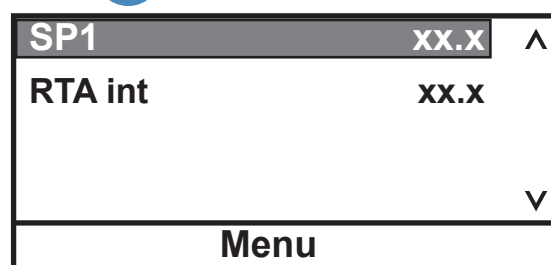



If this temperature on the Start/Status Displays does not accurately reflect the actual temperature in the reservoir, an RTA can be applied. The RTA can be set  $\pm 10^{\circ}\text{C}$  ( $\pm 18^{\circ}\text{F}$ ).

As an example, if the circulator's temperature is stabilized and displaying  $20^{\circ}\text{C}$  but a calibrated reference thermometer reads  $20.5^{\circ}\text{C}$ , set the RTA to  $-0.5^{\circ}\text{C}$ . After you enter a RTA value allow the circulator to stabilize before verifying the bath fluid temperature. **Note** If display accuracy is required, we recommend repeating this procedure at various setpoint temperatures and on a regular basis. ▲

**Note** You cannot adjust the setpoint closer than  $0.1^{\circ}\text{C}$  to either of the fluid's system limits, see Fluids Type in this Section. ▲

5. With the desired line highlighted press .

The right-most digit will have a cursor beneath it. Use the left and right arrows to move the cursor to the desired digit and then use the up and down arrows to change the value. Once all the desired changes are made, press  to save the change or  to cancel it.

**35.0°C**

**Alarms** is used to view/adjust the high and low temperature alarm limits, to enable/disable the audible alarms and to configure the low level warning reaction (SC150/SC150L only). **Note** The alarm range limits depend on the fluid, circulator and bath used, see next page. ▲

1. With **Alarms** highlighted, press  to display:

<b>Temperature Alarms</b>	^
<b>Audible Alarms</b>	
<input type="checkbox"/> <b>Low Level Warning</b>	
	v
<b>Menu</b>	

2. With **Temperature Alarms** highlighted, press  to display:

<b>High Fault</b>	<b>83.0°C</b>	^
<b>High Warn</b>	<b>83.0°C</b>	
<b>Low Warn</b>	<b>2.0°C</b>	
<b>Low Fault</b>	<b>2.0°C</b>	v
<b>Menu</b>		

3. Highlight the desired limit and press . Follow the same procedure used to change a setpoint. If the Fault temperature is exceeded the circulator shuts down and, if enabled, the audible alarm sounds. If the Warn temperature is exceeded the circulator continues to run and, if enabled, the audible alarm sounds. In both cases a message is displayed.

**High Fault** cannot be set below **High Warn**.  
**High Warn** cannot be set below **Low Warn**.  
**Low Fault** cannot be set above **High Warn**.

Press  to return to the previous display.

**Note** Changing the temperature alarms also changes the current setpoint, if it falls outside the new limits. ▲

1. With **Audible Alarms** highlighted, press  to display the alarms.

Highlight the desired alarm and press  to toggle between enable and disable mode.

<input checked="" type="checkbox"/> <b>Faults</b>	^
<input type="checkbox"/> <b>Warnings</b>	
	v
<b>Menu</b>	

Press  to return to the previous display.

1. With **Low Level** highlighted, press  to toggle the low level warning alarm on/off:

<b>Temperature Alarms</b>	^
<b>Audible Alarms</b>	
<input checked="" type="checkbox"/> <b>Low Level Warning</b>	
	v
<b>Menu</b>	

(SC150/SC150L only)

Press  to return to the previous display.

**Fluids Type** is used to identify the type of fluid used. The circulator uses the fluid type to automatically set certain operating parameters.



**Transparent Acrylic Bath and Polyphenylene oxide (PPO) Bath Circulators are used with water only. ▲**

1. With **Fluid Type** highlighted, press  to display the list of approved fluids.

Highlight the desired fluid and then press  to select it.

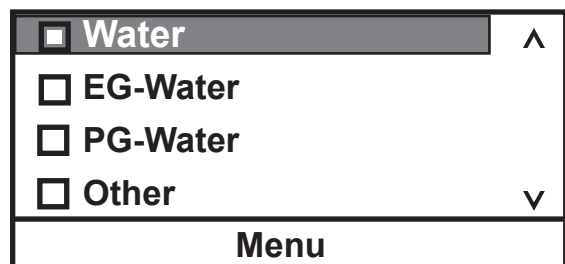

2. With the desired fluid selected press  to return to the previous display.

**Note** The circulator's operating range is determined by the currently selected fluid. When a new fluid is selected the circulator, if necessary, automatically adjusts the temperature alarms and/or setpoint. ▲

**Pump Adjustment** is used to review/set the desired pump speed.

1. With **Pump Adjustment** highlighted, press  to display the speeds.

Highlight the desired speed and press  to select it.

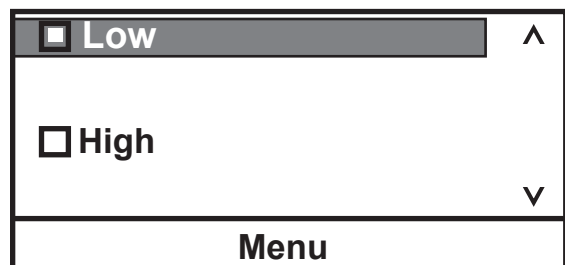

Fluid temperature alarm limits		
	High °C	Low °C
<b>SC 100 immersion circulators:</b>		
Water	+100	+5
Ethylene Glycol-Water	+100	-30
Propylene Glycol-Water	+100	-30
Other	+100	-30
<hr/>		
<b>SC 150 and SC 150L immersion circulators:</b>		
Water	+100	+5
Ethylene Glycol-Water	+100	-30
Propylene Glycol-Water	+100	-30
Other	+100	-30
SIL 100	+75	-28
SIL 180	+150	-28
SIL 300	+150	+80
SYNTH 60	+45	-10
SYNTH 260	+150	+45

**Note** The range is also limited by the bath temperature range, see Section 2. ▲

**Set Clock** is used to set the circulator's **Set Time/Date** (hr : min : sec) and date (year - month - day).

<b>Set Time/Date</b>	^
	v
<b>Menu</b>	

**On/Off Timer** is used to enable and set the circulator's timer.

1. With **On/Off Timer** highlighted, press  to display the on (I) and off (O) time as well as the enable box.

<b>I: 2013-01-16</b>	<b>08:10:00</b>
<b>O: 2013-01-16</b>	<b>10:45:00</b>
<input type="checkbox"/> <b>Enable</b>	
<b>Menu</b>	

After setting the on and off times highlight **Enable** and press  to activate the timer.

**Auto Restart** is used to enable the auto restart feature. When enabled, the immersion circulator automatically restarts after a power failure or power interruption condition is restored. **NOTE** Consider any possible risks before enabling this mode of operation. ▲

1. With **Auto Restart** highlighted, press  to toggle between enable and disable.

**Energy Saving** is used to enable the energy savings mode. The Energy Saving mode is primarily designed for applications running under a stable load. Enabling the mode saves energy by reducing the circulator's heater power and cooling requirements. This can result in substantial energy savings over the life of the circulator. The default setting is disable (enable for A40 refrigerated circulators).

1. With **Energy Saving** highlighted, press  to toggle between enable and disable.

**Interfaces** is used to enable/configure the optional serial communications (SC150/SC150L only).

1. With **Interfaces** highlighted, press  to display the list of parameters.

Highlight the desired parameter and press  to view the available options.

<b>Serial Type</b>	^
<b>Baud</b>	
<b>Parity</b>	
<b>Data Bits</b>	v
<b>Menu</b>	

#### Available options:

<b>Serial Type</b>	Off, RS232, RS485 or Analog IO
<b>Baud</b>	38400, 19200, 9600, 4800, 2400, 1200, 600 or 300
<b>Parity</b>	None, Odd or Even
<b>Data Bits</b>	8 only
<b>Stop Bits</b>	1 or 2
<b>Address</b>	(Displayed with RS485 only)

Supported protocols: AC, Standard, NC, Namur

See the Appendix for additional information.

**Note** Keypad operation is still available with serial communications enabled. ▲





**Settings - Display Options** is used to view/adjust the circulator's Temperature Units, the Temperature Resolution, the displayed Language, the Display Contrast and the Display Delay.

1. With **Temp. Unit** highlighted press .  
Use the up/down arrows to highlight the desired temperature scale.

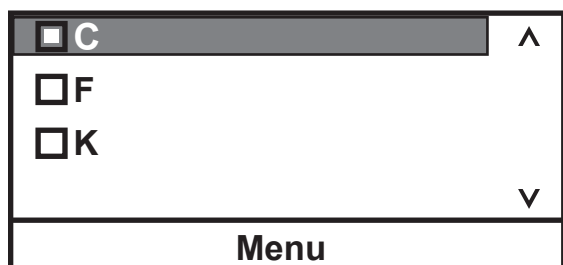
Press .



2. With **Temp. Resolution** highlighted press .

Use the up/down arrows to highlight the desired resolution. Press .

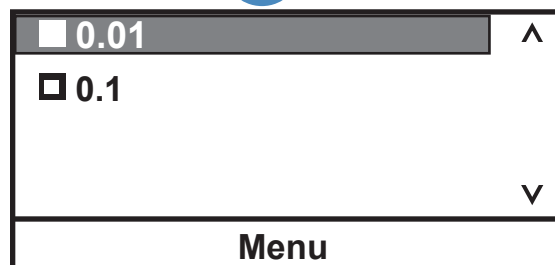

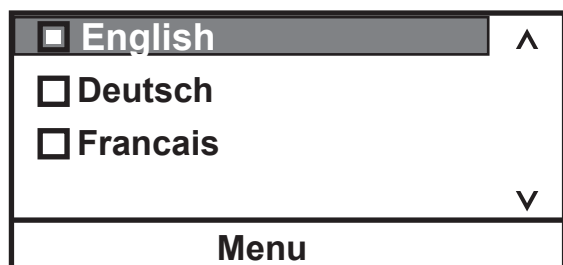

3. With **Language** highlighted press .

Press .



4. With **Display Contrast** highlighted press .

Press  again and use the up/down arrows keys to change the contrast. With the desired contrast showing, press  again.

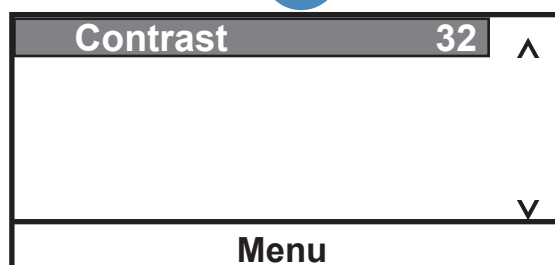

**Note** Holding  for five seconds resets the display contrast to the default level and also brings up the language menu to change, if needed, the displayed language. ▲

5. With **Display Delay** highlighted press  to enable/disable it.

Use the up/down arrows to highlight the time and press  again.

Use the up/down arrows to change the value. Once the desired delay is displayed press .

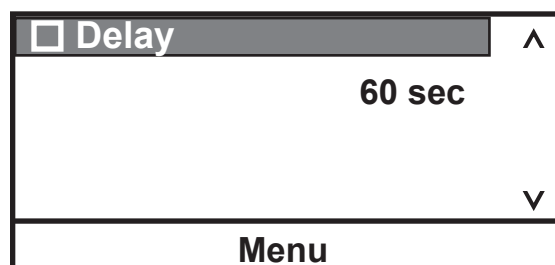

With **Display Delay** enabled and the Start Display showing, if no arrows are pressed the Start Display will change to the Status Display after the delay expires, see pages 4-2 and 4-3.

**System Messages** is used to view any Warning or Fault messages.

1. With **Messages** highlighted, press  to display the options.

<b>Warnings</b>	^
<b>Faults</b>	
	v
<b>Menu</b>	

**System Run Time** is used to view the circulator (**Unit**) and pump operating hours.

1. With **Run Time** highlighted, press  to display the times.

<b>Unit</b>	<b>xxx hours</b>	^
<b>Pump</b>	<b>xxx hours</b>	
		v
<b>Menu</b>		

**System Configuration** is used to view the circulator's configuration.

1. With **Configuration** highlighted, press  to display the settings.

<b>Head</b>	<b>SC150</b>
<b>FW</b>	<b>XXXXXXXX.XX</b>
<b>Checksum</b>	<b>XXXX</b>
<b>Bath</b>	<b>R20; 115V</b>
<b>FW</b>	<b>XXXXXXXX.XX</b>
<b>Menu</b>	

Without a bath connected the display is:

<b>Head</b>	<b>SC150</b>
<b>FW</b>	<b>XXXXXXXX.XX</b>
<b>Checksum</b>	<b>XXXX</b>
<b>Bath</b>	<b>None</b>
<b>FW</b>	<b>XXXXXXXX.XX</b>
<b>Menu</b>	

With an invalid bath connected the display is:

<b>Head</b>	<b>SC150</b>
<b>FW</b>	<b>XXXXXXXX.XX</b>
<b>Checksum</b>	<b>XXXX</b>
<b>Bath</b>	<b>Invd xx</b>
<b>FW</b>	<b>XXXXXXXX.XX</b>
<b>Menu</b>	

**System - Password/Reset** is used only by a qualified technician. Changing the password enables circulator reset options, the temperature sensor calibration procedure and displays PID values.

1. With **Password/Reset** highlighted, press  to display:

Level	User	^
Password	0	
		v
Menu		

2. Press  and change the number to **1**.

Level	User	^
Password	1	
		v
Menu		

3. Press  to display:

Level	Operator	^
Password	1	
Reset		
Calibration		v
Menu		

4. If desired, highlight **Reset** and press  to display:

Reset user settings	^
Reset PID settings	
Reset both	
	v
Menu	

**Note** The circulator resets to the **User** mode when it is turned off. The circulator also resets to the **User** mode when the Start/Status Display is displayed continuously for 10 minutes. ▲

Highlight the desired reset option and press .

A confirmation message will appear, press  again.

The circulator will enter the stand by mode.

5. With **Calibration** highlighted, press  to calibrate the internal temperature sensor. The procedure is covered on the next page,:

6. Scroll down to display **PID Tuning**, see page 4-16.

Level	Operator	^
Password	1	
Reset		
Calibration		v
Menu		

Password	1	^
Reset		
Calibration		
PID Tuning		v
Menu		

**Note** Ensure the RTA is set to 0 before doing a calibration. ▲

1. To calibrate the temperature sensor highlight **Calibration** and press  to display:

Internal RTD	▲
	▼
Menu	

2. Press  to display:

Calibrate	▲
Restore User Cal	
Save User Cal	
Restore Factory Cal	▼
Menu	

3. Press  to display:

Internal RTD	xx.x	▲
High	xx.x	
Low	xx.x	
Calibrate	SP	xx.x ▼
Menu		

4. Highlight the **SP** temperature box and enter either the desired high end or low end setpoint value and press .

Internal RTD	xx.x	▲
High	xx.x	
Low	xx.x	
Calibrate	SP	xx.x ▼
Menu		

5. Depending on which end you are calibrating highlight **High** or **Low**. Once the **Internal RTD** temperature stabilizes enter the temperature displayed on your reference thermometer and press .

Internal RTD	xx.x	▲
High	xx.x	
Low	xx.x	
Calibrate	SP	xx.x ▼
Menu		

6. Highlight **Calibrate** and then press  to complete the high end procedure.

Internal RTD	xx.x	▲
High	xx.x	
Low	xx.x	
Calibrate	SP	xx.x ▼
Menu		

7. Repeat for the low end setpoint.

Internal RTD	xx.x	▲
High	xx.x	
Low	xx.x	
Calibrate	SP	xx.x ▼
Menu		

Once complete you can store the calibration into memory by selecting **Save User Cal** and pressing .

You can later restore the same calibration by highlighting **Restore User Cal** and pressing





Another option is to restore the factory calibration values by highlighting **Restore Factory Cal** and pressing .

1. With **PID Tuning** highlighted, press  to display:

<b>Cool PID</b>	^
<b>Heat PID</b>	
	v
<b>Menu</b>	

2. Highlight the desired PID and press  to display:

<b>P</b>	<b>XX.X</b>	^
<b>I</b>	<b>x.xx</b>	
<b>D</b>	<b>x.xx</b>	
		v
<b>Menu</b>		

3. If required, press  to change the value. Once the desired value is displayed press  again to save it.

<b>P</b>	<b>XX.X</b>	^
<b>I</b>	<b>x.xx</b>	
<b>D</b>	<b>x.xx</b>	
		v
<b>Menu</b>		

Factory values are:

P = 00.6  
 I = 0.60  
 D = 0.00

## High Temperature Cutout

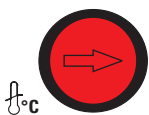

HTC (Temperature range varies with type of immersion circulator.)

To protect your application, the adjustable High Temperature Cutout (HTC) ensures the heater does not exceed temperatures that can cause serious damage. A temperature sensor is located in the reservoir. A HTC fault occurs when the temperature of the sensor exceeds the set temperature limit.

In the event of a fault the circulator shuts down and displays a fault message, see Section 7. The cause of the fault must be identified and corrected before the circulator can be restarted. A low reservoir fluid level is a primary reason for the HTC to trip.

The HTC is factory preset fully clockwise to the highest possible setting. To set the cutout start the circulator and adjust the setpoint a few degrees higher than the highest desired fluid temperature. Allow the circulator to stabilize at the temperature setpoint. Then, using a flathead screwdriver, slowly turn the red dial counterclockwise until the circulator shuts down and the fault message appears. Press  to clear the message.

Before you can restart the circulator it has to cool down a few degrees. To restart the circulator press the black reset ring surrounding the red dial - and then press  again. If Auto Restart is enabled the circulator restarts, if disabled use the Start Up procedure.

**Note:** We recommend periodically rechecking operation or if the circulator is moved. ▲

## Decommissioning/ Disposal



Decommissioning prepares equipment for safe and secure transportation.

**Laboratory Grade Ethylene glycol (EG) is poisonous and flammable. Before disposing refer to the manufacturer's most current MSDS for handling precautions. ▲**



**Decommissioning must be performed only by qualified dealer using certified equipment. All prevailing regulations must be followed. ▲**

Consider decommissioning the circulator when:

- It fails to maintain desired specifications
- It no longer meets safety standards
- It is beyond repair for its age and worth

Refrigerant (R134A) and oil (POE or Ester) must be recovered from equipment before disposal.

**Note** Keep in mind any impact your application may have had on the circulator. ▲

Direct questions about chiller decommissioning or disposal to our Sales, Service and Customer Support.



**Handling and disposal should be done in accordance with the manufacturers specification and/or the MSDS for the material used. ▲**

## Storage



**If the circulator is to be transported and/or stored in cold temperatures it needs to be drained and then flushed with a 50/50 laboratory grade glycol/water mixture. ▲**

The circulator can be stored for up to 90 days inside the temperature range of -25°C to +60°C (-13°F to +140°F).

If necessary, when removing the circulator from storage allow it time to warm up and dry out in order to prevent any condensation issues.

## Section 5 Accessories

### Lifting Platform Installation



#### Tools required:

- Torx Head screwdriver
- M15 or adjustable wrench

#### Procedure:

Always turn off the circulator and disconnect the power cord from the power source before installing the platform. ▲

1. Undo the four thumbscrews securing the immersion circulator to the bridge and remove it.
2. Undo the four Torx head screws securing the bridge to the bath and remove the bridge.
3. Secure the stacks to the platform. **Note** the long end of the stack is installed into the hole on the platform as shown. ▲
4. Insert the sockets into the holes on the top of the bridge. Secure the sockets to the bridge using a M15 nut on the bottom of each socket.
5. Slide the stacks up and through the sockets on the bridge.
6. Install a male knurled nut into each socket and install a female knurled nut to the top of the stack.
7. Place the assembly in the bath and secure it to the circulator using the four Torx head screws.
8. Place the immersion circulator on the bridge and secure it using the four thumbscrews, hand tight.
9. Place the lifting platform to the desired position and lock it by using the male knurled nuts.

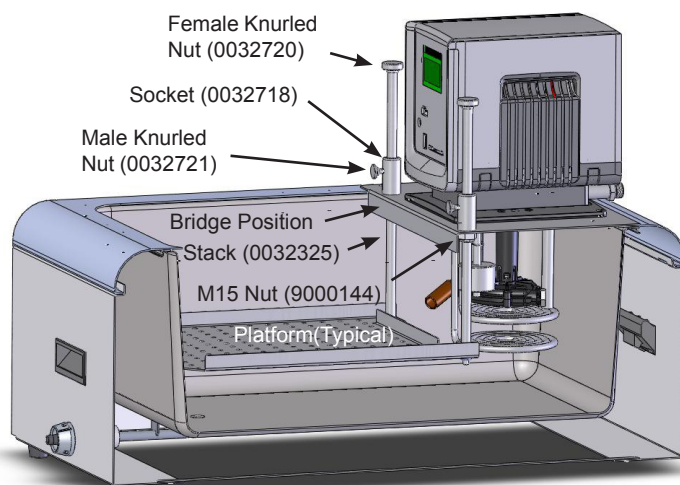



## Immersion Cooler Bridge Installation



### Tools required:

- Phillips Head screwdriver

### Procedure:

Always turn off the circulator and disconnect the power cord from the power source before installing the bridge. ▲

1. Undo the four thumbscrews securing the immersion circulator to the top panel and remove it.
2. Undo the four Phillips Head screws securing the top panel to the bath and remove it.
3. Turn the old panel over and note the placement of its three gaskets. Using the old panel as a template, install the three supplied gaskets in the same position on the new panel. **Note** Place the panels on a soft clean cloth, their stainless steel surfaces are susceptible to scratching. ▲
4. Place the immersion cooler bridge on the bath and secure it using the four Phillips Head screws.
5. Place the immersion circulator on the top panel and secure it using the four thumbscrews, hand tight.
6. Remove the two screws securing the "dummy" panel to the immersion cooler bridge.
7. Insert the immersion circulator head through the hole.
8. Secure the head to the top panel using the two supplied panels.

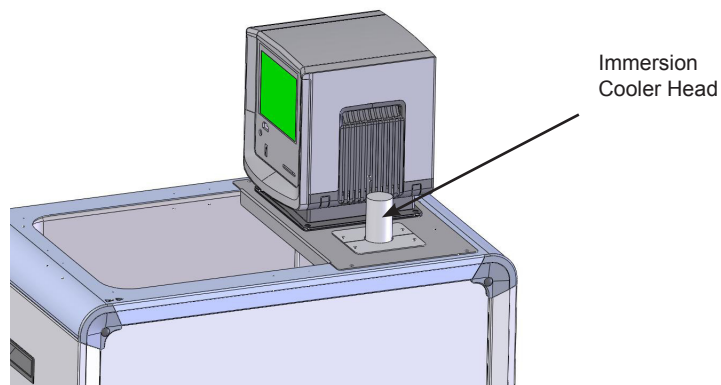

## Rack Assembly Instructions

Used with part numbers:  
1600002, 1600026, 1600079

### Tools required:

- Phillips screwdriver

### Procedure:

**Note** all four support parts are identical, the lower-support is the upper-support rotated 180°.

1. If required, align the top and bottom rack supports to the desired height. **Note** Install the rack supports to the base rack using only the supplied M4 x 8MM stainless steel screws.

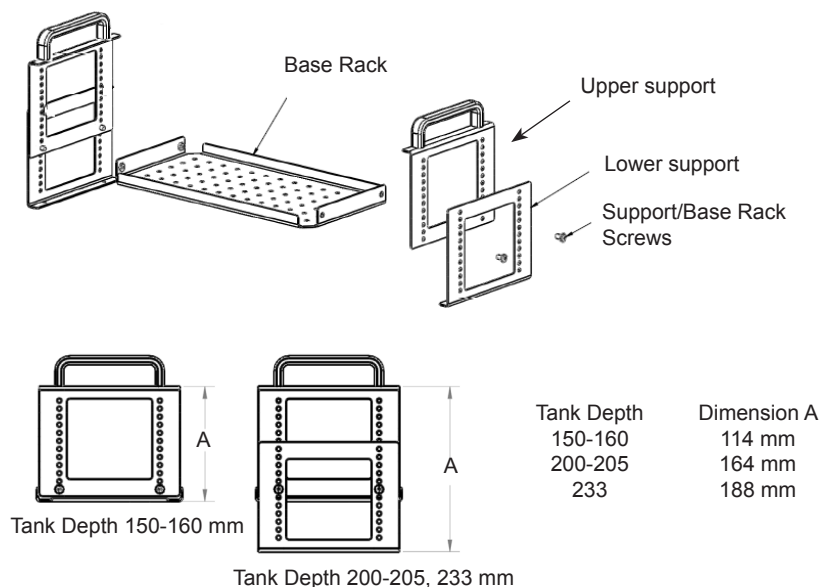

### Insert part numbers:

1600003 to 1600006

1600080 to 1600083

1600084 to 1600087

1600066 and 1600067

2. Once the base rack is attached to the supports, install any optional inserts at the desired heights. Use only the supplied M4 x 8MM stainless steel screws.

### Optional Stainless Steel Inserts:

A5B, A10B, A24B, S49, S19T, S14P, S21P (283 x 145 mm)

A25B, A40, S21, S30 (160 x 145 mm)

S13, S12T (160 x 100 mm)

- 10 mm test tube holes
- 16 mm test tube holes
- 25 mm test tube holes
- No holes

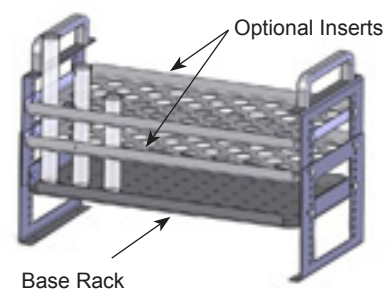

# Serial Communications Adapter



Tools required:

- None

Procedure:

Turn off the circulator before installing the adapter. ▲

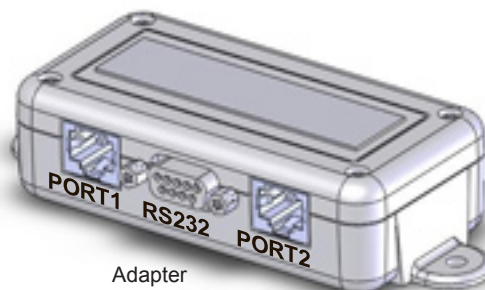

Adapter



Pin #	Function
1	No connection
2	TX
3	RX
4	No connection
5	GND = Signal ground
6 - 9	No connection



Pin #	Function
1-7	No connection
8	T+
9	T-

TX = Transmitted data from circulator  
 RX = Received data to circulator.

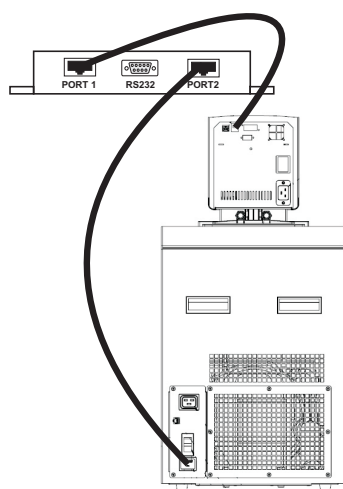

1. If the circulator already has a communication cable installed, remove the cable from the rear of the immersion circulator and plug that cable into PORT 2 on the adapter.
2. Plug the supplied cable into PORT 1 on the adapter and the other end into the immersion circulator. Regardless of the configuration, the supplied cable *always* goes from the immersion circulator to PORT 1.
3. Plug your 9-pin serial communications cable into the communication port on the adapter and then the other end into your computer. Cables are available from Thermo Fisher.
4. If desired, use the supplied Velcro<sup>®</sup> tape to attach the adapter to a convenient location on the circulator.

## Tubing

Description	Order-No.
Insulated metal tubes made from stainless steel with M 16 x 1 unions on both ends. -90 to +105 °C temperature range	
100 cm (39") long	333-0578
150 cm (59") long	333-0579
coupling	001-2560
Insulated metal tubing made from stainless steel with M 16 x 1 unions on both ends. -50 to +300 °C temperature range	
50 cm (20") long	333-0292
100 cm (39") long	333-0293
150 cm (59") long	333-0294
tube coupling	001-2560
PVC tubing (water only)	
8 mm i.d. (available per meter)	082-0745
12 mm i.d. (available per meter)	082-0304
Viton tubing -60 to +200 °C temperature range	
8 mm i.d. (available per meter)	082-1214
12 mm i.d. (available per meter)	082-1215
Silicone tubing -30 to +220 °C temperature range (not to be used with any silicone oil, i.e., SIL or Synth 60)	
8 mm i.d. (available per meter)	082-0663
12 mm i.d. (available per meter)	082-0664
Perbunan tubing -40 to +100 °C temperature range	
8 mm i.d. (available per meter)	082-0172
12 mm i.d. (available per meter)	082-0173
Foam rubber insulation for PVC, Viton, Silicone and Perbunan tubes	
8 mm i.d. (available per meter)	806-0373
12 mm i.d. (available per meter)	806-0374
Fittings for plastic tubing	
8 mm i.d.	001-1209
12 mm i.d.	001-1210
Coupling nut	001-0797



## Section 6 Preventive Maintenance



Disconnect the power cord prior to performing any maintenance. ▲

Handle the circulator with care. Sudden jolts or drops can damage its components. ▲

### Cleaning

After time, the circulator's stainless steel surfaces may show spots and become tarnished. Clean the reservoir and built-in components at least every time the reservoir fluid is changed. Only use water and a soft cloth.



Do not use scouring powder. ▲

The inside of the bath must be kept clean in order to ensure a long service life. Quickly remove substances containing acidic or alkaline substances and metal shavings as they could harm the surfaces causing corrosion. If corrosion (e.g., small rust marks) occurs in spite of this, cleaning with stainless steel caustic agents has proved to be suitable. Apply these substances according to the manufacturer's recommendations.



Do not use any substances which contain solvents. ▲

### Condenser Fins

For refrigerated baths, in order to maintain the cooling capacity of the circulator, clean the fins two to four times per year, depending on the operating environment.

Switch off the circulator and unplug the power cord.

For ARCTIC A40

- 1 Remove the condenser panel.
- 2 Clean fins with brush or similar tool.
- 3 Replace the panel.

For all other refrigerated baths:  
Clean the fins with compressed air.

For extreme soiling a qualified technician will need to remove the cooling compressor casing.

### Tubing

Inspect and tighten the tubing and clamps daily.

## Grounding Strap and Nut



Sahara baths require immersion circulator grounding.

If the circulator is removed for any reason you must ensure the nut and washer secures to the grounding strap located on the rear of the tank top when the circulator is reinstalled. ▲

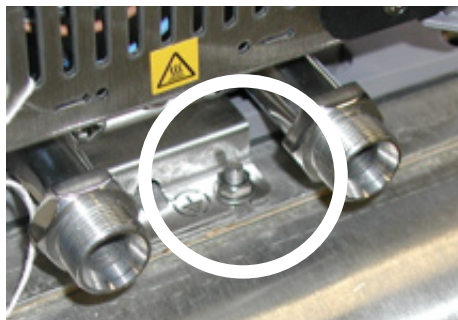

## Testing the Safety Features



### High temperature protection

Use a flat head screwdriver to turn the arrow to the desired temperature.

Set a cut-off temperature that is lower than the desired setpoint temperature.

Switch on the circulator and ensure it shuts down at the set cut-off temperature.

After the circulator cools down clear the HTC error message by pressing the black ring surrounding the red dial - and then press . If Auto Restart is enabled the circulator restarts, if disabled use the Start Up procedure.

If the circulator did not shut down have it checked by a qualified technician.

Reset the safety to the desired temperature.



**Limit all acrylic bath's maximum high temperature setting to the temperature indicated on the label on the front of the bath, 80°C. ▲**

### Low liquid level protection

With the circulator on, use a screwdriver and slowly push down on each level sensor, one at a time, until an error message appears. See Section 7 for details on error messages.

If not, have the circulator checked by a qualified technician.

## Error Displays

## Section 7 Troubleshooting

The circulator can display error messages and, if enabled, sound an alarm. Error messages are cleared by pressing the enter key (↵). Restart the circulator once the cause of the error message is identified and corrected. If the cause was not corrected the error code will reappear, contact our Sales, Service and Customer Support. If **Auto start** is enabled the circulator will restart, if disabled use the Start Up procedure.

**FAULT:**  
**High Temperature**  
**PRESS ENTER**  
**to clear message**

Error Display (Typical)



### Fault Displays

The heating element, pump and, if applicable, refrigeration shut down with a fault. A fault also sounds the alarm, if enabled.

Message	Cause	Actions
<b>Bath not found</b>	<ul style="list-style-type: none"> <li>a loss of communication between refrigerated bath and circulator</li> </ul>	<ul style="list-style-type: none"> <li>clear message by pressing the enter key (↵)</li> <li>check cable connections on the rear of the bath and circulator</li> </ul>
<b>High Fixed Temp.</b>	<ul style="list-style-type: none"> <li>circulator's nonadjustable high temperature protection limit exceeded</li> </ul>	<ul style="list-style-type: none"> <li>clear message by pressing the enter key (↵)</li> <li>check fluid selection</li> <li>check environmental conditions</li> </ul>
<b>High Temperature</b>	<ul style="list-style-type: none"> <li>adjustable high temperature protection limit exceeded</li> </ul>	<ul style="list-style-type: none"> <li>clear message by pressing the enter key (↵)</li> <li>check limit setting</li> <li>check fluid selection</li> <li>ensure circulator has adequate ventilation</li> </ul>
<b>High Temperature Refrigeration</b>	<ul style="list-style-type: none"> <li>high refrigeration temperature</li> </ul>	<ul style="list-style-type: none"> <li>clear message by pressing the enter key (↵)</li> <li>check voltage supply</li> <li>the refrigeration may need servicing, contact us</li> </ul>
<b>HPC High Press. Cutout</b>	<ul style="list-style-type: none"> <li>the high refrigeration pressure cutout activated</li> </ul>	<ul style="list-style-type: none"> <li>clear message by pressing the enter key (↵)</li> <li>check for obstructions to air flow</li> <li>the refrigeration may need servicing, contact us</li> </ul>







Message	Cause	Actions
<b>HTC High Temp. Cutout</b>	<ul style="list-style-type: none"> <li>the high temperature cutout limit was exceeded</li> </ul>	<ul style="list-style-type: none"> <li>clear message by pressing the enter key (↵)</li> <li>turn the red knob on the HTC fully clockwise</li> <li>press the HTC's black reset ring </li> <li>press the enter key (↵) again</li> <li>reset HTC to desired setting, see Section 4</li> <li>if message reappears recycle power to circulator and repeat the procedure</li> </ul>
<b>LLC Low Level Cutout</b>	<ul style="list-style-type: none"> <li>reservoir fluid level too low for safe operation</li> </ul>	<ul style="list-style-type: none"> <li>clear message by pressing the enter key (↵)</li> <li>check fluid level</li> <li>check for leaks</li> </ul>
<b>High Level</b>	<ul style="list-style-type: none"> <li>reservoir fluid level too high for safe operation</li> </ul>	<ul style="list-style-type: none"> <li>clear message by pressing the enter key (↵)</li> <li>check fluid level, drain excess fluid if required</li> <li>verify optional auto refill operation</li> </ul>
<b>Low Fixed Temp.</b>	<ul style="list-style-type: none"> <li>circulator's nonadjustable low temperature protection limit exceeded</li> </ul>	<ul style="list-style-type: none"> <li>clear message by pressing the enter key (↵)</li> <li>check fluid selection</li> </ul>
<b>Low Temperature</b>	<ul style="list-style-type: none"> <li>adjustable high temperature protection limit exceeded</li> </ul>	<ul style="list-style-type: none"> <li>clear message by pressing the enter key (↵)</li> <li>check limit setting</li> <li>check fluid selection</li> </ul>
<b>Motor Fault</b>	<ul style="list-style-type: none"> <li>high motor temperature</li> </ul>	<ul style="list-style-type: none"> <li>clear message by pressing the enter key (↵)</li> <li>it can take over 10 minutes for the motor temperature to get low enough before the circulator can be restarted</li> </ul>
<b>MOL Motor Overload</b>	<ul style="list-style-type: none"> <li>high motor overload temperature</li> </ul>	<ul style="list-style-type: none"> <li>clear message by pressing the enter key (↵)</li> <li>allow circulator to cool down</li> </ul>

Message	Cause	Actions
<b>Open RTD1 Internal</b>	<ul style="list-style-type: none"> <li>open internal temperature sensor</li> </ul>	<ul style="list-style-type: none"> <li>clear message by pressing the enter key (  )</li> <li>contact us</li> </ul>
<b>Shorted RTD1 Internal</b>	<ul style="list-style-type: none"> <li>shorted internal temperature sensor</li> </ul>	<ul style="list-style-type: none"> <li>clear message by pressing the enter key (  )</li> <li>contact us</li> </ul>

### Warning Displays

The circulator will continue to run with a warning. A warning also sounds the alarm, if enabled.

Message	Cause	Actions
<b>Bad Calibration</b>	<ul style="list-style-type: none"> <li>bad temperature probe calibration</li> </ul>	<ul style="list-style-type: none"> <li>clear message by pressing the enter key (  )</li> <li>redo calibration</li> </ul>
<b>High Temperature</b>	<ul style="list-style-type: none"> <li>adjustable high temperature protection limit exceeded</li> </ul>	<ul style="list-style-type: none"> <li>clear message by pressing the enter key (  )</li> <li>check limit setting</li> <li>check fluid selection</li> </ul>
<b>Low Level</b>	<ul style="list-style-type: none"> <li>reservoir fluid level too low for safe operation</li> </ul>	<ul style="list-style-type: none"> <li>clear message by pressing the enter key (  )</li> <li>check fluid level</li> </ul>
<b>Low Temperature</b>	<ul style="list-style-type: none"> <li>adjustable low temperature protection limit exceeded</li> </ul>	<ul style="list-style-type: none"> <li>clear message by pressing the enter key (  )</li> <li>check limit setting</li> <li>check fluid selection</li> </ul>

## Checklist

### Circulator will not start

Check the display for error codes, see Error Codes in this section.

Ensure the circuit protector(s) is in the on (I) position.

Make sure supply voltage is connected and matches the circulator's nameplate rating  $\pm 10\%$ .

### No display

Recycle the circuit protector on the rear of the circulator.

### Circulator will not circulate process fluid

Check the reservoir level. Fill, if necessary.

Check the application for restrictions in the cooling lines.

The pump motor overloaded. The pump's internal overtemperature overcurrent device will shut off the pump causing the flow to stop. This can be caused by low fluid, debris in system, operating circulator in a high ambient temperature condition or excessively confined space. Allow time for the motor to cool down.

Ensure supply voltage matches the circulator's nameplate rating  $\pm 10\%$ .

### Inadequate temperature control

Verify the setpoint.

For refrigerated baths, ensure the condenser is free of dust and debris.

Check the fluid concentration.

Ensure circulator installation complies with the site requirements in Section 3.

Ensure supply voltage matches the nameplate rating  $\pm 10\%$ .

If the temperature continues to rise, ensure your application's heat load does not exceed the rated specifications.

Enter the controller menu and ensure the ENERGY SAVER mode is on in order for the system to maintain a stable temperature.

Check for high thermal gradients (e.g., the application load is being turned on and off or rapidly changing).

**Circulator shuts down**

Ensure  button wasn't accidentally pressed.

Ensure the circuit protector(s) is in the on (I) position.

Check the display for error codes.

Make sure supply voltage is connected and matches the nameplate rating  $\pm 10\%$ .

Restart the circulator.

**USB Driver Not Recognized**

If your operating system does not automatically recognize the optional driver log on to:

<http://www.ftdichip.com/FTDrivers.htm>

for instructions.

Please contact Thermo Fisher Scientific Sales Service and Customer Support if you need any additional information, see inside cover for contact instructions.



# Appendix AC Serial Communications Protocol

Serial communication is accomplished either through the optional 9-pin Serial Communications Box or through the USB port on the immersion circulator. If your operating system does not automatically recognize the optional driver log on to: <http://www.ftdichip.com/FTDrivers.htm> for instructions.

**Note** This appendix assumes you have a basic understanding of communications protocols. Information on the NC, STANDARD and NAMUR protocols is available upon request.

**Note** Keypad operation is still available with serial communications enabled.

**Note** NC protocol is required to use RS485 device addressing.

All commands must be entered in the exact format shown in the tables on the following pages. The tables show all commands available, their format and responses. Controller responses are either the requested data or an error message. The controller response must be received before the host sends the next command.

The host sends a command embedded in a single communications packet, then waits for the controller's response. If the command is not understood, the controller responds with an error command. Otherwise, the controller responds with the requested data.

Commands are not case sensitive. Upper or lower case letters may be used. Commands are listed in the Commands Table, error responses are given in the Errors Table, and symbols are shown in the Key Table.

Key	
Symbol	Meaning
[B]	A binary value 0 or 1 (0 = Off, FALSE or Disable(d); 1 = On, TRUE or Enable(d)).
[CR]	Carriage return – used as the termination character.
[U]	Text representing the units associated with a value.
[V]	A value that can be requested in a read command or sent as part of a set command.
[V <sub>MAX</sub> ]	Maximum allowed value. Part of error message when set value is too high.
[V <sub>MIN</sub> ]	Minimum allowed value. Part of error message when set value is too low.

Value: Read commands return analog [V] or bit [B] values or settings, while set commands send analog or bit settings. Read commands return values in the same displayed precision. Set command messages missing the space character between the command and the setting will be rejected, as the user's intent is unclear.

Units: A read command returning an analog [V] value or setting, will include the units [U] associated with that value or setting. A set command sending an analog value will not include the units. The units returned by the complementary read command are assumed.

Termination character: A carriage return [CR] is used to terminate command and response messages. (Typically the "Enter" key on the keyboard.)

**Note** The inter-character timeout (time between transmitted characters) is set to 30 seconds. Exceeding the timeout will clear the receiver buffer and require the message to be retransmitted.

**Note** Special characters (backspace, delete, insert, etc.) are not recognized and generate error responses.

<b>Commands Table</b>			
Commands      All messages from master and slave are terminated with a carriage return [CR]			
Command Description	Master Sends	Sample Slave Response (echo off)	Alternate units
Read Temperature Internal	RT	[V]C	F K
Read Displayed Setpoint	RS	[V]C	F K
Read Internal RTA1 – Internal RTA5	RIRTA1 – 5	[V]C	F K
Read Setpoint X (X = 1 to 5)	RSX	[V]C	F K
Read High Temperature Fault	RHTF	[V]C	F K
Read High Temperature Warn	RHTW	[V]C	F K
Read Low Temperature Fault	RLTF	[V]C	F K
Read Low Temperature Warn	RLTW	[V]C	F K
Read Proportional Heat Band Setting	RPH	[V]%	
Read Proportional Cool Band Setting	RPC	[V]%	
Read Integral Heat Band Setting	RIH	[V]Repeats per minute	
Read Integral Cool Band Setting	RIC	[V]Repeats per minute	
Read Derivative Heat Band Setting	RDH	[V]Minutes	
Read Derivative Cool Band Setting	RDC	[V]Minutes	
Read Temperature Precision	RTP	[V]	
Read Temperature Units	RTU	[V]      C,F,K	
Read Unit On	RO	[B]	
Read Auto Restart Enabled	RAR	[B]	
Read Energy Saving Mode	REN	[B]	
Read Time	RCK	hh:mm:ss	
Read Date	RDT	mm/dd/yyyy or dd/mm/yyyy	
Read Date Format	RDF	mm/dd/yyyy or dd/mm/yyyy	
Read Firmware Version	RVER	[V]	
Read Firmware Checksum	RSUM	[V]	
Read Unit Fault Status	RUFS	[V1, V2 , V3, V4, V5] See page A-4	

Commands      All messages from master and slave are terminated with a carriage return [CR]		
Command Description	Master Sends	Sample Slave Response
Set Displayed Setpoint	SS [V]	OK
Set Internal RTA1 – Internal RTA5	SIRTA1 – SIRTA5 [V]	OK
Set Setpoint X (X = 1 to 5)	SSX [V]	OK
Set High Temperature Fault	SHTF [V]	OK
Set High Temperature Warning	SHTW [V]	OK
Set Low Temperature Fault	SLTF [V]	OK
Set Low Temperature Warning	SLTW [V]	OK
Set Proportional Heat Band Setting	SPH [V]	OK
Set Proportional Cool Band Setting	SPC [V]	OK
Set Integral Heat Band Setting	SIH [V]	OK
Set Integral Cool Band Setting	SIC [V]	OK
Set Derivative Heat Band Setting	SDH [V]	OK
Set Derivative Cool Band Setting	SDC [V]	OK
Set Temperature Resolution	STR [V]	OK
Set Temperature Units	STU [V] C,F,K	OK
Set Unit On Status	SO [B]	OK
Set Auto Restart Enabled	SAR [B]	OK
Set Energy Saving Mode	SEN [V]	OK
Set Pump Speed	SPS [V] L,M,H	OK

Error Table	
Errors	
Error Description	Slave Responds
Not defined, not implemented or incorrectly formatted	? Unsupported command
Extra characters...	? Format error
Set value too high	? Maximum allowed is $[V_{MAX}]$
Set value too low	? Minimum allowed is $[V_{MIN}]$
Argument to binary set command not 0 or 1	? Value must be 0 or 1
Set command attempted while in read only mode	? Mode is read only
Set command failed (e.g. SO 1 with low level)	? Failed



## RUFS Read Unit Fault Status

This command returns 5 values. These are decimal representations of hexadecimal values. Each individual bit of the value represents a different warning, fault or status.

decimal	hex	B7	B6	B5	B4	B3	B2	B1	B0
1	1	0	0	0	0	0	0	0	1
2	2	0	0	0	0	0	0	1	0
4	4	0	0	0	0	0	1	0	0
8	8	0	0	0	0	1	0	0	0
16	10	0	0	0	1	0	0	0	0
32	20	0	0	1	0	0	0	0	0
64	40	0	1	0	0	0	0	0	0
128	80	1	0	0	0	0	0	0	0

Value	Description of bits	Value	Description of bits
V1	B0 – B5 unused B6 rtd1 shorted B7 rtd1 open	V2	B0 HTC fault B1 high RA temperature fault B2 – B7 unused
V3	B0 low level warn B1 low temperature warn B2 high temperature warn B3 low level fault B4 low temperature fault B5 high temperature fault B6 low temperature fixed fault B7 high temperature fixed fault	V4	B0 PWM heat duty cycle > 0 B1 compressor on/off B2 pump on status B3 circulator on status B4 circulator stopping B5 circulator fault status B6 unused B7 beeper on status
V5	B0 pump speed fault B1 MOL fault B2 HPC fault B3 cool icon on steady (circulator is cooling at max capacity) B4 cool icon flashing (circulator is cooling) B5 heat icon on steady B6 heat icon flashing B7 external sensor controlling		

Refer to Key table on page 1 for explanation of symbols and their meanings.

Examples:

Read Temperature:

Host

R	T		<b>CR</b>
Command			[CR]

Controller:

2	0	.	0	C	<b>CR</b>
[V]			[U]	[CR]	

Set Setpoint:

Host

S	S		2	0	<b>CR</b>
Command			[V]	[CR]	

Controller:

O	K	<b>CR</b>
Command Accepted		[CR]

Read Temperature 2:

Host:

R	T	2	<b>CR</b>		
2	0	.	0	C	[CR]

Controller:

Set Setpoint to -22°C when minimum allowed is -20°C: Minimum allowed is  $[V_{MIN}]$

Host:

S	S		-	2	2	<b>CR</b>															
?		M	i	n	i	m	u	m	a	l	l	o	w	e	d	i	s	-	2	0	<b>CR</b>

Controller:

## DECLARATION OF CONFORMITY



Manufacturer: Thermo Fisher Scientific  
Address: 25 Nimble Hill Road  
Newington, NH 03801 USA

Date of inception 2009

We declare that the following products conform to the Directives and Standards listed below.

Products: ThermoTemp Refrigerated and non refrigerated heated liquid baths  
All rated 100Vac-50HZ & 60Hz or 115Vac-60Hz or 230Vac-50Hz.

Refrigerated and non refrigerated heated liquid baths:

Models: SC100, SC150, SC150L, AC150 or AC200 control head assembled with an A5B, A10B, A25B, A10, A25, A28, A28F, A40, G50, S3, S7, S13, S15, S21, S30, S45, S49, S5P, S14P S21P, S6T, S12T or S19T.

Control heads, intended as a component for use only in the ThermoTemp product line of refrigerated and non refrigerated liquid baths.

Models: SC100, SC150, SC150L, AC150, AC200, PC200 & PC300.

Bath assemblies intended as a component for use only with ThermoTemp control heads.

Models: A5B, A25, A10B, A24B, A25, A25B, A28 & A40.

Immersion circulators:

Models: SC100, SC150, SC150L, AC150, AC200, PC200, PC201 & PC300.

ThermoTemp bath accessories, not mains connected:

BOM #: 1600027, 1600075 & 1600076.

Equipment Class: Measurement, control and laboratory

Directives and Standards:

2004/108/EC – Electromagnetic Compatibility ( EMCD ):

EN 61326-1: 2006 – Electrical equipment for measurement, control, and laboratory use – EMC Requirements - EMC Class A.

2006/95/EC – Low Voltage Directive ( LVD ):

EN 61010-1: 2010 – Safety requirements for electrical equipment for measurement, control, and laboratory use: general requirements.

En 61010-1: 2001 – Safety requirements for electrical equipment for measurement, control, and laboratory use: General requirements.

En 61010-2-010: 2003 – Safety requirements for electrical equipment for measurement, control, and laboratory use – part 2-010: Particular requirements for laboratory equipment for the heating of materials.

2011/65/EU - Restriction of the Use of Certain Hazardous Substances In Electrical and Electronic Equipment ( ROHSD ).

EN 50581: 2012 - Technical documentation for the assessment of electrical and electronic products with respect to the restriction of hazardous substances.

2012/19/EU - Waste from Electrical and Electronic Equipment ( WEEEED ).

Manufacturer's Authorized Representative:

Date:

Robin Wiley Compliance Engineering

14 July 2014

## RoHS DECLARATION OF CONFORMITY

Manufacturer: Thermo Fisher Scientific

Address: 25 Nimble Hill Road  
Newington, NH 03801 USA

Products: Standard ThermoTemp refrigerated and non refrigerated heated liquid baths and their associated standard accessories.

Thermo Fisher Scientific certifies that the above ThermoTemp models meet the requirements of DIRECTIVE 2002/95/EC, Restriction of Hazardous Substances Directive ( RoHS ). Thermo Fisher Scientific certifies that these ThermoTemp models contains less than the following amounts of the six RoHS banned substances with the exemption stated in Note 2 below:

Substance		Threshold Level
Lead...	Pb	Less than 0.1% <sup>1 &amp; 2</sup>
Mercury...	Hg	Less than 0.1% <sup>1</sup>
Hexavalent Chromium ...	Cr (VI)	Less than 0.1% <sup>1</sup>
Polybrominated Biphenyls ...	PBB	Less than 0.1% <sup>1</sup>
Polybrominated Diphenyl Ethers ...	PBDE	Less than 0.1% <sup>1</sup>
Cadmium ...	Cd	Less than 0.01% <sup>1</sup>
Notes:		
1. Tolerated maximum concentration value by weight in homogeneous materials.		
2. Exemptions - Lead as an alloying element in steel containing up to 0.35% lead by weight, aluminum containing up to 0.4% lead by weight and as a copper alloy containing up to 4% lead by weight.		

Manufacturer's Authorized Representative:

Date:

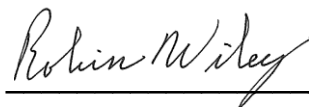
  
\_\_\_\_\_

20 Sept. 2013

Robin Wiley Compliance Engineering

# Warranty

For the special sales promotional period between May 1, 2015 and September 30, 2015 the warranty period and conditions below are extended to 48 months from date of shipment for the ARCTIC and SAHARA Bath circulators only. This promotion does not cover standalone Immersion Circulators.

Otherwise, Thermo Fisher Scientific warrants for 36 months from date of shipment the Thermo Scientific STANDARD series of Immersion Circulators, ARCTIC refrigerated/heated bath circulators, and SAHARA heated bath circulators according to the following terms.

Any part of the product manufactured or supplied by Thermo Fisher Scientific and found in the reasonable judgment of Thermo Fisher to be defective in material or workmanship will be repaired at an authorized Thermo Fisher Repair Depot without charge for parts or labor. The product, including any defective part must be returned to an authorized Thermo Fisher Repair Depot within the warranty period. The expense of returning the product to the authorized Thermo Fisher Repair Depot for warranty service will be paid for by the buyer. Our responsibility in respect to warranty claims is limited to performing the required repairs or replacements, and no claim of breach of warranty shall be cause for cancellation or rescission of the contract of sales of any product. With respect to products that qualify for field service repairs, Thermo Fisher Scientific's responsibility is limited to the component parts necessary for the repair and the labor that is required on site to perform the repair. Any travel labor or mileage charges are the financial responsibility of the buyer.

The buyer shall be responsible for any evaluation or warranty service call (including labor charges) if no defects are found with the Thermo Scientific product.

This warranty does not cover any product that has been subject to misuse, neglect, or accident. This warranty does not apply to any damage to the product that is the result of improper installation or maintenance, or to any product that has been operated or maintained in any way contrary to the operating or maintenance instructions specified in this Instruction and Operation Manual. This warranty does not cover any product that has been altered or modified so as to change its intended use.

In addition, this warranty does not extend to repairs made by the use of parts, accessories, or fluids which are either incompatible with the product or adversely affect its operation, performance, or durability.

Thermo Fisher Scientific reserves the right to change or improve the design of any product without assuming any obligation to modify any product previously manufactured.

THE FOREGOING EXPRESS WARRANTY IS IN LIEU OF ALL OTHER WARRANTIES, EXPRESSED OR IMPLIED, INCLUDING BUT NOT LIMITED TO WARRANTIES OR MERCHANTABILITY AND FITNESS FOR A PARTICULAR PURPOSE.

OUR OBLIGATION UNDER THIS WARRANTY IS STRICTLY AND EXCLUSIVELY LIMITED TO THE REPAIR OR REPLACEMENT OF DEFECTIVE COMPONENT PARTS AND Thermo Fisher Scientific DOES NOT ASSUME OR AUTHORIZE ANYONE TO ASSUME FOR IT ANY OTHER OBLIGATION.

Thermo Fisher Scientific ASSUMES NO RESPONSIBILITY FOR INCIDENTAL, CONSEQUENTIAL, OR OTHER DAMAGES INCLUDING, BUT NOT LIMITED TO LOSS OR DAMAGE TO PROPERTY, LOSS OF PROFITS OR REVENUE, LOSS OF THE PRODUCT, LOSS OF TIME, OR INCONVENIENCE.

This warranty applies to products sold by Thermo Fisher Scientific. Any product sold elsewhere are warranted by the affiliated marketing company of Thermo Fisher Scientific. This warranty and all matters arising pursuant to it shall be governed by the law of the State of New Hampshire, United States. All legal actions brought in relation hereto shall be filed in the appropriate state or federal courts in New Hampshire, unless waived by Thermo Fisher Scientific.



Thermo Fisher Scientific  
81 Wyman Street  
P.O. Box 9046  
Waltham, Massachusetts 02454-9046  
United States

[www.thermofisher.com](http://www.thermofisher.com)