

## Operating Instructions Thermo Scientific Barnstead Pacific-TII Water Purification System

- [ ] Art. No.: 50132121 TII 3
- [ ] Art. No.: 50132123 TII 7
- [ ] Art. No.: 50132124 TII 12
- [ ] Art. No.: 50132125 TII 20
- [ ] Art. No.: 50132127 TII 40

- [ ] Art. No.: 50132129 TII 3 UV
- [ ] Art. No.: 50132131 TII 7 UV
- [ ] Art. No.: 50132132 TII 12 UV
- [ ] Art. No.: 50131982 TII 20 UV
- [ ] Art. No.: 50132133 TII 40 UV



Serial no.: .....

**These Operating Instructions must be read prior to installing and starting the system!**

50132138; 02.13 Information given is not binding. Rights reserved for technical changes.



## EC-Declaration of Conformity

in accordance with the EEC machine directive 2006/42/EC, appendix II A

We hereby certify that the following described machine in its conception and form put by us into circulation is in accordance with all the relevant essential health and safety requirements of the EC machinery directive 2006/42/EC as amended and the national laws and regulations adopting this directive.

This declaration is no longer valid if the machine is modified without our consent.

**Manufacturer:** Thermo Electron LED GmbH  
Robert-Bosch-Straße 1  
D-63505 Langenselbold  
Germany

### Description of the machine:

function: Pure water system

type: Pacific TII

article number: 50132121, 50132123, 50132124, 50132125, 50132127  
50132129, 50132131, 50132132, 50131982, 50132133

**The agreement with further valid guidelines/regulations following for the product is explained:**

EMC Directive (2004/108/EC)

### Reference to the harmonised standards:

DIN EN ISO 12100-1 Safety of machinery, Part 1: Basic terminology  
DIN EN ISO 12100-2 Safety of machinery, Part 2: Technical principles  
DIN EN ISO 14121-1 Safety of machinery, Part 1: Risk assessment  
DIN EN 61326-1

### Authorized person for the technical documentation:

Detlef Opp  
Stockland 3  
D-56412 Niederelbert

Niederelbert, 1. April 2010

Detlef Opp, Head of Technical documentation

  
Signature

## Preface

Dear Sir or Madam,

In deciding to purchase a **Pacific TII** water purification system, you have selected a high-quality product.

Thank you for the trust you have placed in us.

Please read carefully through the information given in these Operating Instructions before you begin to install and commission the system.

This is of particular importance as we, the manufacturer, cannot be held liable for any damage that results from use other than for the intended purpose, or from improper operation of the system.

Niederelbert, 01.04.2010

## Contents

Preface.....	3
1. Contents.....	4
2. Explanatory notes on the operating instructions .....	6
3. Transport and Packaging .....	7
3.1 Examination on receipt .....	7
3.2 Complaints .....	7
3.3 Packing for return delivery .....	7
4. Extent of delivery .....	8
5. Safety precautions .....	9
6. Intended use .....	12
7. Technical specifications .....	13
8. Flow chart .....	15
8.1 Flow chart, Pacific TII/TII UV tank with pressure pump .....	15
8.2 Flow chart, Pacific TII/TII UV tank without pressure pump .....	15
8.3 System description.....	16
9. How Pacific TII functions.....	18
10. Installation location .....	19
11. Bringing the system into service .....	20
11.1 Wall mounting .....	22
11.2 Mounting the power pack (voltage supply).....	23
12. Operating elements.....	24
13. System Control .....	25
13.1 User menu .....	25
13.1.1 Permeate conductivity:.....	25
13.1.2 Pure water limiting value: .....	26
13.1.3 Operating hours: .....	26
13.1.4 Pretreatment operating hours: .....	27
13.1.5 Cleaning: .....	27
13.1.6 Disinfection :.....	28
13.1.7 Fault storage: .....	28
13.1.8 Unlocking the system: .....	29
13.2 OEM-menu.....	30
13.2.1 Maximum temperature: .....	30

13.2.2	Disinfection time: .....	31
13.2.3	Recirculation time: .....	31
13.2.4	Rinsing time: .....	31
13.2.5	Rinse interval time .....	32
13.2.6	Real time clock: .....	32
13.2.7	Sending interval: .....	32
13.2.8	Language: .....	33
13.2.9	Switching units: .....	33
13.2.10	Switch off temperature compensation: .....	33
13.2.11	Adjusting the circuit hysteresis of the float switch: .....	34
13.2.12	Programme choice, TII UV, RO: .....	34
13.2.13	Entering the type and serial number of the system: .....	34
<b>14.</b>	<b>Maintenance .....</b>	<b>35</b>
14.1	Maintenance intervals .....	36
14.2	Cleaning the membrane .....	36
14.3	Changing the reverse osmosis membrane .....	37
14.4	Changing the filter cartridge .....	38
14.5	Disinfection .....	39
<b>15.</b>	<b>Waste disposal .....</b>	<b>41</b>
<b>16.</b>	<b>Trouble shooting .....</b>	<b>42</b>
<b>17.</b>	<b>Replacement parts for Pacific TII .....</b>	<b>46</b>
<b>18.</b>	<b>Replacement parts for the optional tank .....</b>	<b>47</b>
<b>19.</b>	<b>Consumables .....</b>	<b>48</b>
<b>20.</b>	<b>Accessories .....</b>	<b>48</b>
<b>21.</b>	<b>Terminal assignment .....</b>	<b>49</b>
21.1	Pacific TII 3-20/TII 3-20 UV (24V) .....	49
21.2	Pacific TII 40/TII 40 UV (48V) .....	50
<b>22.</b>	<b>Maintenance record .....</b>	<b>51</b>

## 2. Explanatory notes on the operating instructions



EU Mark of Conformity



CSA – admission



Important operating and/or maintenance instructions! Read the operating instructions with due care.

Risk of electric shock! Electrical work on the system is only to be carried out by qualified personnel.



General information! Particularly important notes are marked with this information sign.



Protective conductor connection

Connect the power supply to an electrical socket with a protective connection.

The information provided in these operating instructions is only valid for the system which has the serial number which is to be entered on the front page.



Please enter the serial number\* of your Pacific TII / TII UV system in the space provided on the front page.

\* Read the serial number of your pure water system from the type plate.

For quick and correct service, please include the following information on all inquiries and replacement parts orders which relate to your system:

- The serial number
- The article number

### 3. Transport and Packaging

Water purification systems are carefully controlled and packed prior to dispatch, but damage could possibly occur during transport.

#### 3.1 Examination on receipt

- Check the completeness of the goods received against the delivery note.



#### Is the packaging damaged?

- Inspect the system for damage.

#### 3.2 Complaints

Should damage to the goods have occurred during transport:

- Contact the post, railway or forwarding agent immediately\*.
- Save the complete packaging (for a possible inspection or return delivery).

#### 3.3 Packing for return delivery

Use the original boxes and other packaging material if possible.

Should these no longer be available:

- Pack the goods in a suitable bag or sheet and a sturdy cardboard box so that they are protected against impact.



**\* The time limit for claims is 6 days from the receipt of the goods.  
The right to claim for damages ceases after this period.**

## 4. Extent of delivery

The Pacific-TII system that you have ordered consists of:

1	Pacific TII basic system	Article-No. 5013xxxx
1	Filterset	Article-No. 09.4011
2	PVC-connecting hose, 1,5 m	Article-No. 18.0042
1	PE-hose 8/6 x 1, 2m	Article-No. 18.0036
1	PE-hose 6/4 x 1, 2m	Article-No. 18.0047
2	Screw hook	Article-No. 21.0057
2	Nylon Dowel	Article-No. 21.0035
1	Operating instructions	Article-No. 50132138
1	Connecting cord (rubber connector to nema plug connector)	Article no. 50132200
1	Connecting cord (rubber connector to british ST plug connector)	Article no. 50132203
1	Connecting cord (rubber connector to euro plug connector)	Article no. 50132215
1	Table power unit 24V DC	Article no. 50134196
1	Table power unit 48V DC (only TII 40/ TII 40 UV)	Article no. 50134184
1	Universal adapter	Articel no. 21.1006
1	Universal holder	Articel no. 21.1007



Please compare the articles delivered with the list above.  
Contact the manufacturer should a part be missing.



## 5. Safety precautions



**For your own safety, please observe the above safety precautions!**

- Pacific TII system is a modularly constructed, pure water system that serves exclusively for the purification of tap water.
- Do not put the system into operation until you have taken notice of all of the appropriate information that is given in these Operating Instructions.
- Lifting and carrying the pure water system, e.g. to the installation location, should be carried out by two people. To lift it, each takes hold of it under the base plate at two corners.
- Note that the manufacturer is freed of all liability for damages that result from improper operation of the system, or from use of it for other than the intended purpose.
- The CE-Mark becomes invalidated should constructional changes be made to the system or products of other manufacturers be installed in it.
- Protect the system from frost. The temperature in the area in which the system is installed must be at least +2° C and must not exceed + 40° C.
- Observe all regulations and requirements, including current accident regulations, that are applicable and appropriate at the installation area, including those for the statics of the flooring (see weight under „Technical specifications“).
- The raw water pressure must be at least 2 bar and at most 6 bar, should it be higher, then an additional pressure reducer must be installed.
- DIN EN 1717 requires that water purification systems be equipped with a safety device that protects against contamination of the drinking water piping.
- An earthed 100-250V / 50/60Hz socket must be available.
- The installation area must have a drain at floor level with at least DN 50 pipe, otherwise the manufacturer will not accept any liability for water damage.
- Gravity fall to the waste drain must be ensured.
- When the system is to be wall-mounted, check the statics of the wall for sufficient load-bearing capacity (see Technical Data for the weight of your system).

The pure water system only be mounted on a concrete wall or a solid masonry.

- Positioning the system so that operation of the power separation unit is not made difficult.
- After long standstill periods (e.g. holidays), the system must be subjected to rinsing and, if appropriate, disinfection. Refer to the section on "Cleaning and disinfection" for details.
- When selecting the installation area and installing the system, make sure that there is sufficient working area around the system for convenient operation of it.

- Never look directly into a switched-on UV-lamp, as UV-light is dangerous to eyesight. The UV-lamp is only to be replaced by authorized person to do this.
  
- The guarantee is valid for a period of 12 months.

## 6. Intended use

The Pacific TII pure water system is a reaction to the continually increasing requirements that water of pure quality must fulfil, the increasingly strict demands resulting from technological advances and the need for user-friendly systems and complete solutions.

Pacific TII systems have been solely and specifically designed to excel in the intended use, which is to produce sterile filtered pure water free of particles, salts and organic compounds.

To benefit from the long possible service lives of the high-quality purification media, feed the pure water system with water which has been subjected to an upstream pre-treatment step (reverse osmosis, ion exchange or distillation),

### - Analytical techniques in laboratories:

- HPLC ( **H**igh **P**erformance **L**iquid **C**hromatography )
- IC ( **I**on **C**hromatography )
- ICP ( **I**nductive **C**oupled Argon **P**lasma )
- AAS ( **A**tomically **A**bsorption **S**pectrophotometry )
- TOC Analysis ( **T**otal **O**rganic **C**arbon )
- DNA Research
- etc.

### - Reagent and solution preparation:

- Cell culture media
- Tissue culture media
- Make-up water for reagents for on-line analytical systems

### - Water for high-purity rinse processes on a laboratory scale

## 7. Technical specifications

The feedwater quality required	
Source and pre-treatment	Tap water, softened or hardness stabilized.
Blocking index (SDI)	Max. 3 for all types. With higher values, a pre-treatment system (Art. No. 09.4000 or 09.4001) must be installed upstream
Resistance	> 0.001 MΩxcm
Prefiltration	5 µm
Free chlorine concentration	< 0.1 mg/Litre
Manganese content	< 0.05 mg/Litre
Iron content	< 0.05 mg/Litre
Colloid index	< 3
pH-Range	4 – 11
Temperature	2 – 35 °C
Pressure	2 – 6 bar

Product water quality					
	TII/TII UV 3	TII/TII UV 7	TII/TII UV 12	TII/TII UV 20	TII/TII UV 40
Salt retention quota	Ø 98 %	Ø 98 %	Ø 98 %	Ø 98 %	Ø 98 %
Retention quota, bacteria and particles	99 %	99 %	99 %	99 %	99 %
Performance	3 L/h	7 L/h	12 L/h	20 L/h	40 L/h

Dimensions	
Height	603 mm
Width	372 mm
Depth	330 mm
Weight:	
Pacific-UP/UPW 3	24 kg
Pacific-UP/UPW 7	24 kg
Pacific-UP/UPW 12	25 kg
Pacific-UP/UPW 20	25 kg
Pacific-UP/UPW 40	25 kg

Cell constants of the measuring cells	
Permeate conductivity	0.16 cm <sup>-1</sup>
High purity water conductivity	0.01 cm <sup>-1</sup>

Water connections	
Raw water inlet	R 3/4"
Concentrate outlet	R 3/4"
High purity water outlet	Hose, 8 mm OD
Recirculation	Hose, 6 mm OD

Airborne sound emission	
Sound-pressure level	49 db(A)

Electrical connections / external switched mode power supply TII 3-20/ TII 3-20 UV	
Input voltage	AC 100 – 240 V, 50 – 60 Hz, 5 – 3.8 A
Output voltage	DC 24 V, 3.8 A
System connection	DC 24 V, 80 W
Serial interface	RS 232
Protection Class	Class II (external SMPS certified as Class I)

Electrical connections / external switched mode power supply TII 40/ TII 40 UV	
Input voltage	AC 100 – 250 V, 50 – 60 Hz, 4 – 2.5 A
Output voltage	DC 48 V, 2.5 A
System connection	DC 48 V, 120 W
Serial interface	RS 232
Protection Class	Class II (external SMPS certified as Class I)

Ambient conditions (DIN EN 61010-1 (VDE 0411-1):2011-02)	
Usage	Indoor rooms
Height	Up to 2000 m
Temperature range	From 5° C to 40° C
Relative humidity	Maximum relative humidity 80 % at temperatures of up to 31° C, linearly decreasing to 50 % relative humidity at 40° C
Line-voltage variation	Not more than $\pm 10$ % of the line voltage
Transient overvoltages	As usually occur in the supply network (overvoltage category II acc. To IEC 60364-4-443). <u>Note:</u> The rated level of transient overvoltage is the withstand impulse voltage acc. To overvoltage category II of IEC 60364-4-443
Ventilation requirements	There are no special requirements with regard to ventilation.
Degree of pollution	2

Materials of parts that contact water	
Pump head	Nylon with glass fibre
Filter cartridge	PP
Rinsing solenoid valve	PA
Conductivity measuring cell	POM, stainless steel
Distribution block	POM
Connectors	POM
Hoses	PE
Gaskets	EPDM

## 8. Flow chart

### 8.1 Flow chart, Pacific TII/TII UV tank with pressure pump

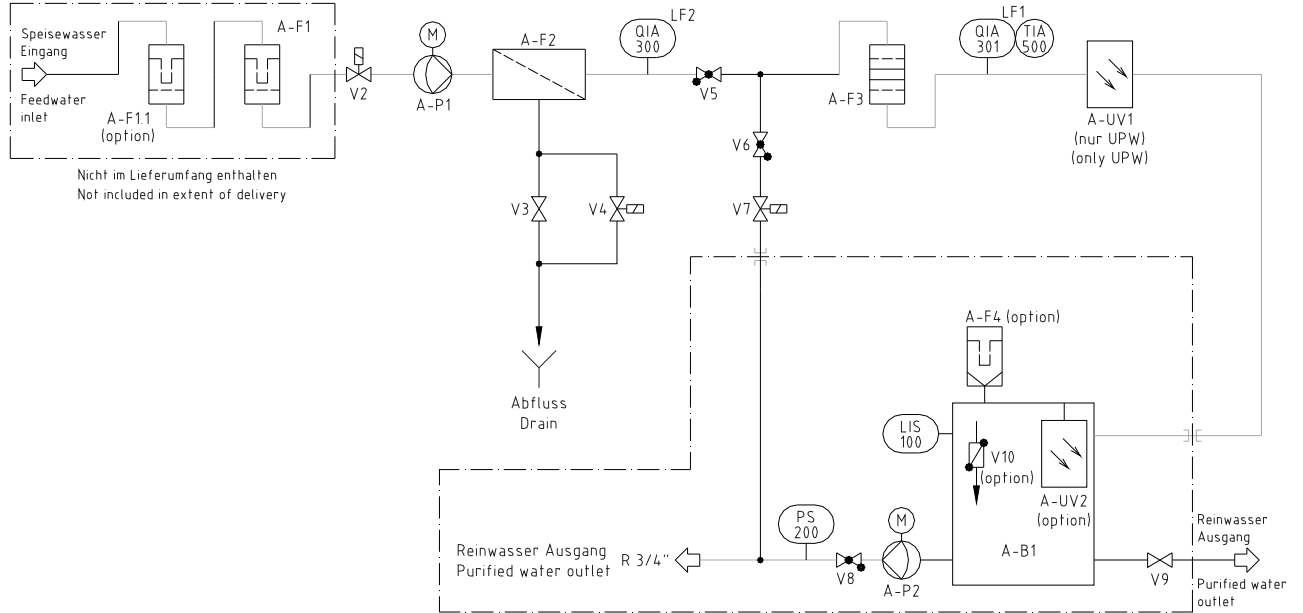

### 8.2 Flow chart, Pacific TII/TII UV tank without pressure pump

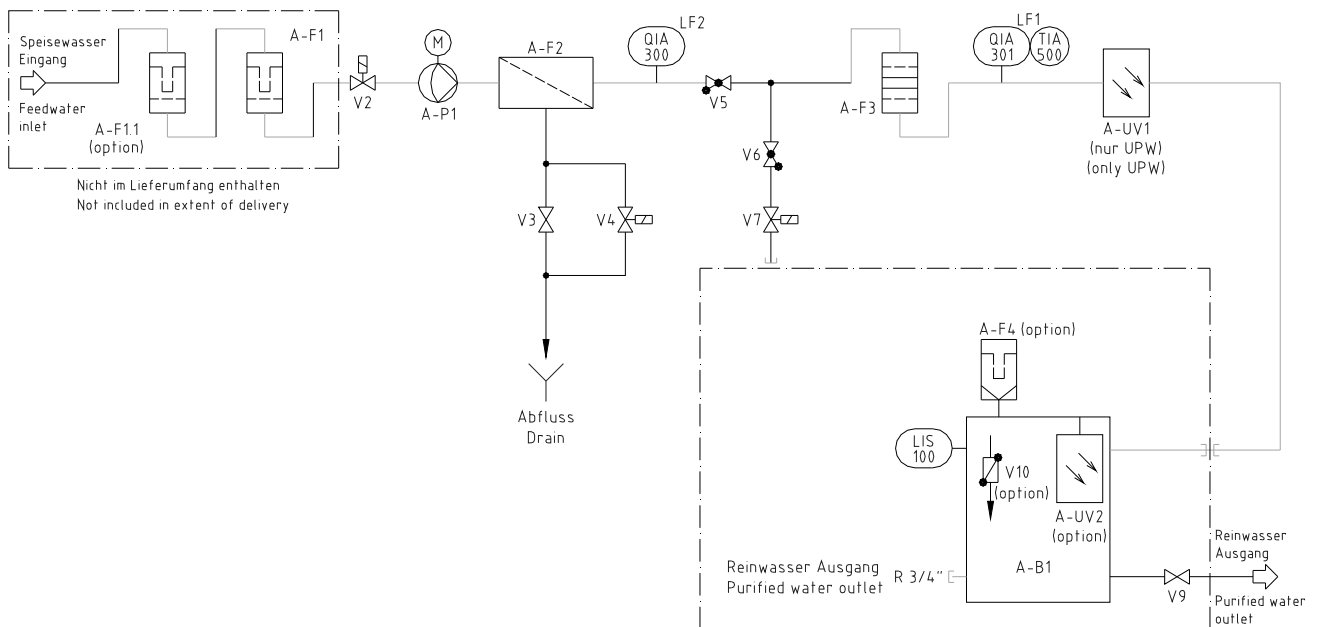

### 8.3 System description

A-F1	Prefilter 5 µm + and hardness stabilizer	Prevents particles > 5µm from entering the system.  Serves to stabilize water hardness.
A-F1.1	Prefilter 1 µm (option, only if necessary)	Prevents particles > 1µm from entering the system.
V2	Feedwater solenoid valve:	Is closed when the system is at stand-by or at a standstill. It prevents water from flowing in when the system is not in use.
A-P1	Pressure boosting pump:	Raises the inlet pressure up to the required operating pressure.
A-F2	Reverse osmosis module:	Contains a semi-permeable, thin film composite spiral-wound membrane.
V3	Pressure hold valve:	Serves for adjustment of the operating pressure and the water conversion factor (see section 8).
V4	Rinsing solenoid valve:	Opens when the membrane is to be cleaned, prior to and after production of high purity water and at least every 12 hours.
QIA 300	Permeate conductivity cell:	Measurement device for determining the conductivity of the water subsequent to reverse osmosis, as parameter for permeating water quality.
V5	Check valve:	Prevents water backflow into the reverse osmosis module when the system is operated in emergency supply mode. Enables the required outlet pressure to be attained during recirculation.
V6	Check valve:	
V7	Recirculating solenoid valve:	Opens for recirculation.
A-F3	Special Ion exchanger /Adsorber filter cartridge:	Removes inorganic ions and traces of dissolved organic compounds.
QIA 301	High purity water conductivity cell:	Device for measuring the conductivity of the water subsequent to the filter cartridge, as a parameter that indicates the quality of the water.
TIA 500	Temperature sensor	Measures the temperature for temperature compensation.
A-UV1	UV-Disinfection (only TII UV)	Destroys bacteria.
A-B1	Tank for high purity water	For storage of the high purity water produced.



A-F4 Sterile venting filter:	Prevents bacteria and particles > 0.2 µm from being drawn into the tank.
LIS 100 Level switch	Indicates the level in the tank.
A-UV2 UV-Disinfection tank: (option)	Reduces the content of bacteria in the water and so serves to prevent bacterial growth and the formation of a biofilm on the inside surfaces of the storage tank.
V9 Dispensing valve:	For withdrawal of high purity water from the tank.
V10 Sterile tank overflow: (option)	Prevents the penetration of bacteria and other micro-organisms.
A-P2 Pressure pump:	Pumps water through the pressure switch to the user.
V8 Check valve:	Prevents water backflow into the tank.
PS 200 Pressure switch::	Switches the pressure pump off when no water is being drawn from the tank.

## 9. How Pacific TII functions

Tap water of max. 6 bar pressure flows into the system.

In stand-by mode and during standstill, feedwater solenoid valve V2 is closed. This prevents feedwater from flowing into the system when it is not in operation, and so protects the tank against overflowing.

Semi-permeable membrane A-F2 retains dissolved salts in the feedwater within the specified retention quota. Further to this, the molecular size of the pores of the membrane ensures Ø 99% retention of bacteria, pyrogens and particles.

Following reverse osmosis, the permeate flows past conductivity probe QIA 300 and through the downstream purification stages such as deionization, adsorption and UV-disinfection (only UPW) into the tank.

The retained feedwater constituents are flushed away with the concentrate flow. The special conductivity probe QIA 301 (with temperature compensation) determines the conductivity of the high purity water (subsequent to the filter cartridge), that can be called to display in the microprocessor control menu.

Pure water is pumped to the user by a downstream tank with pressure pump A-P2. Float switch LIS 100 senses the filling level in the tank.

Pump A-P2 simultaneously serves to recirculate the water stored in the storage tank. It so prevents bacterial growth during standstills and ensures a uniform water quality.



**Pressure hold valve V3 has been pre-adjusted at the factory. Changes to the adjustment could result in damage to the reverse osmosis module! Because of possible fluctuations in feedwater temperature and pressure, the adjustment of the valve and the concentrate flow that it governs must be checked on starting up and re-adjusted as necessary by Service at regular intervals.**

<b>Concentrate flow for Pacific TII</b>			
Check and readjust all 6 months			
Version	Permeate flow [L/h]	Concentrate flow	
		[L/h]	△ WCF-rate [%]
Pacific TII/TII UV 3	3	40	
Pacific TII/TII UV 7	7	40	13
Pacific TII/TII UV 12	12	60	17
Pacific TII/TII UV 20	20	60	25
Pacific TII/TII UV 40	40	110	26

Your purified water system is equipped with automatic flushing. Flushing is carried out when the system is switched on, when production is stopped, and every 12 hours. Solenoid valve V4 is opened and the strong inflow of water across the reverse osmosis module flushes coarse particles and other contaminants away from the surface of the membranes and carries them with it to drain.

Automatic flushing has a positive effect on the service life of the reverse osmosis module. An additional advantage of automatic flushing is that it prevents bacterial growth from occurring in the reverse osmosis module when the system is at a standstill for a length of time. For this reason, we highly recommend that you leave the system switched on over the weekend and during holiday times, so that the 12 hour flush can effectively guard against bacterial growth.

## 10. Installation location

The following criteria must be considered when choosing the installation area:

- Minimum temperature at the installation area, +2° C to +40° C.
- The standing surface or the wall where the system is to be stood or mounted must have sufficient weight-bearing capacity (see Technical specifications for weight).  
  
The pure water system only be mounted on a concrete wall or a solid masonry.
- A floor drain with a DN 50 (38,5 mm ID) waste pipe is required. Should this not be available, then a water watcher (article no.: 16.0129) must be installed to guard against water damage!
- An unrestricted gravity fall of concentrate to the floor drain must be ensured.
- An electrical socket appropriate to the voltage given on the type plate of the system must be available near to the system. The safety fuse must be appropriate to the power required (see Technical specifications).
- There must be sufficient working room around the system.
- A male R ¾" feedwater connection that can be turned off must be installed in the direct vicinity of the system.
- A wastewater connection must be available in the direct vicinity of the system
- There must be sufficient working room around the system.

## 11. Bringing the system into service

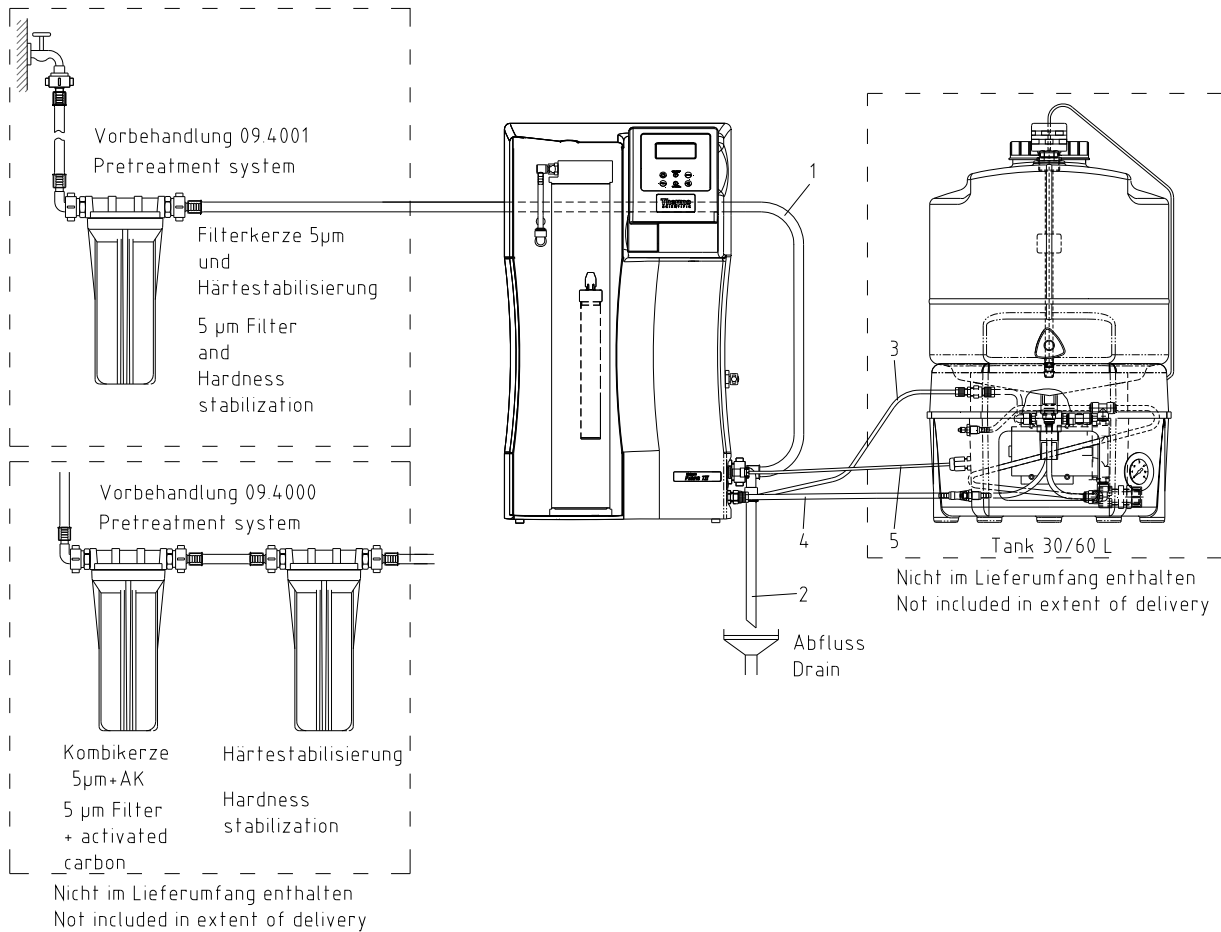

### Pacific connectors

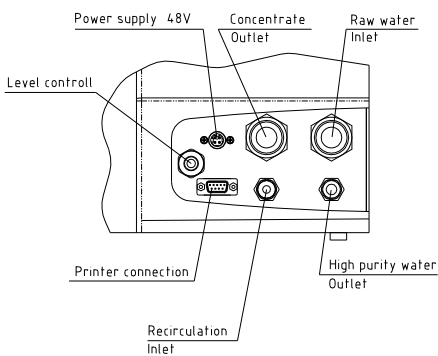

### Tank connectors

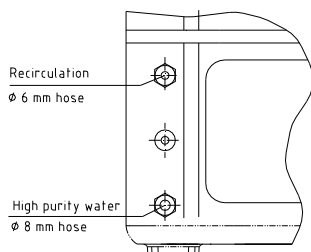

09 Use the R  $\frac{3}{4}$ " hose supplied to connect the feedwater inlet connector of the system (labelled „raw water“) to the prefilter outlet. Use a further hose (R  $\frac{3}{4}$ " hose, accessory for the pretreatment system) to connect the prefilter inlet to the closed water tap.

2. Use the second R  $\frac{3}{4}$ " hose supplied to connect the „Concentrate“ outlet of the system to the on-site drain. The drain to the sewer must be max. Are 1 m above the rinsing water connector of the unit.  
**Important!** The concentrate must be able to flow to drain by free gravity fall.

3.+4. PacificTII UV with external tank (optional):  
Connect the Pacific high purity water outlet to the tank high purity water inlet with the 8 mm diameter hose supplied, and the Pacific recirculation inlet to the tank recirculation outlet with the 6 mm diameter hose supplied with the tank.

5. Connect the tank supply cable to the 4-pin plug of the system.



In order to ensure a perfect function of the sterile overflow, the gas cap must be firmly locked.

6. Put now the hose of the sterile overflow  $\varnothing$  8 mm into the over-flow on the tank back and connect these with the drain
7. Open the feedwater tap.
8. Check that all connections are secure and do not leak.
9. Check the feedwater pressure. It must be maintained within the specified pressure range (see Technical specifications).



**Before you switch the system on, read the procedure for rinsing reverse osmosis membranes supplied in preservative solution in the „Rinsing and disinfection“ section!**

10. Switch the system on at the on/off switch.
11. After a brief flush, your system produces purified water which flows into the tank.

## 11.1 Wall mounting

Ansicht von hinten  
View back side

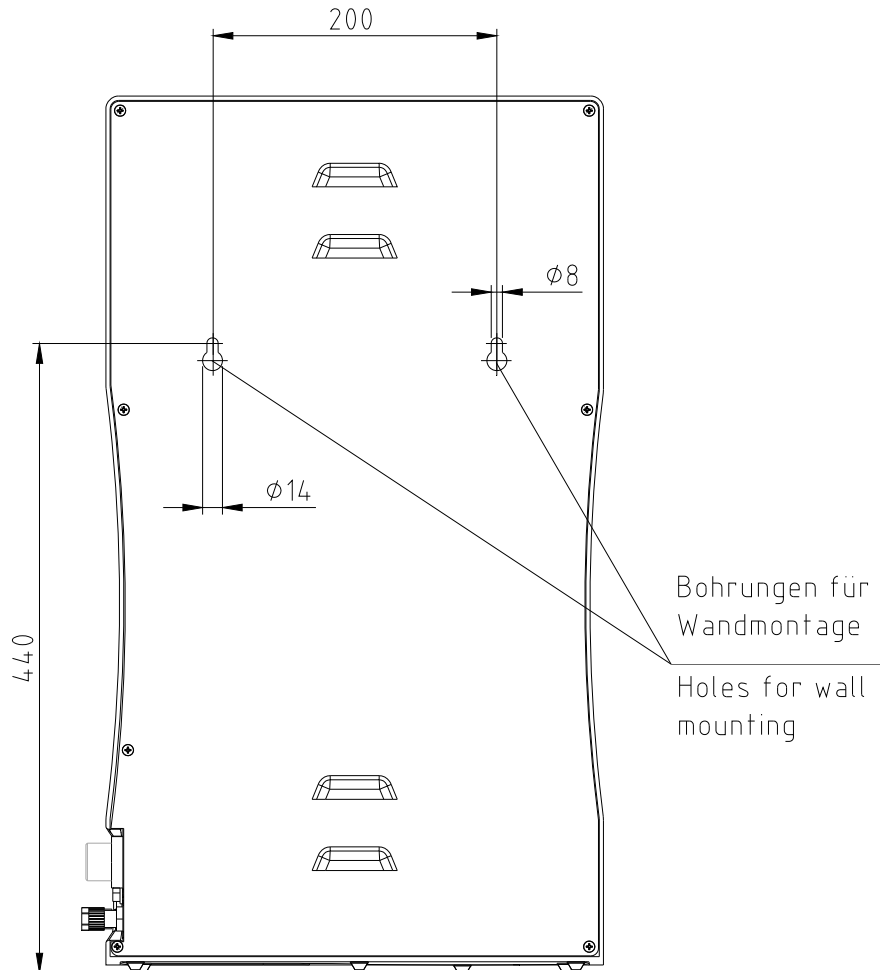

### Proceed as follows to mount your Pacific TII system to a wall:

- 09 Use a twist drill (8mm or 5/16 inch) to make the two holes in the wall that are required as shown in the diagram above.
- 2) Plug the nylon S8 dowels that are supplied in the assembly kit in the holes. Screw the 5.2 x 50 mm screw hooks that are also supplied in the assembly kit in the dowels.
- 3) Lift the Pacific TII system (2 people are required for this) and hang the back side of it on the scfew hooks.

## 11.2 Mounting the power pack (voltage supply)

Rückseite / Netzteil  
Back side / power supply

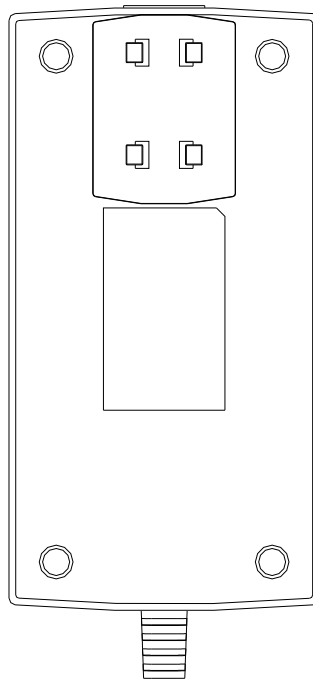

Universaladapter  
Universal adapter

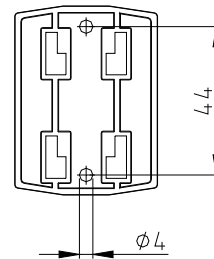

Befestigung  
mit Schrauben  
Fixing with screws

- Whenever possible, mount the power pack on the wall to the left or right of the pure water system where it is freely accessible.
- Stick the universal holder which is supplied in the assembly kit to the back of the power pack as shown in the above Figure.
- Stick the universal adapter to a smooth wall surface or screw it to the wall using the dowels and screws supplied in the assembly kit.
- When the universal holder and universal adapter have been fitted, hang the power pack in.
- Plug the connecting cable (appliance cable) in the power pack socket.
- Connect the power pack to the pure water system (Power supply 24/48V, 4-pin power supply connector).
- The system is now ready for use.

## 12. Operating elements

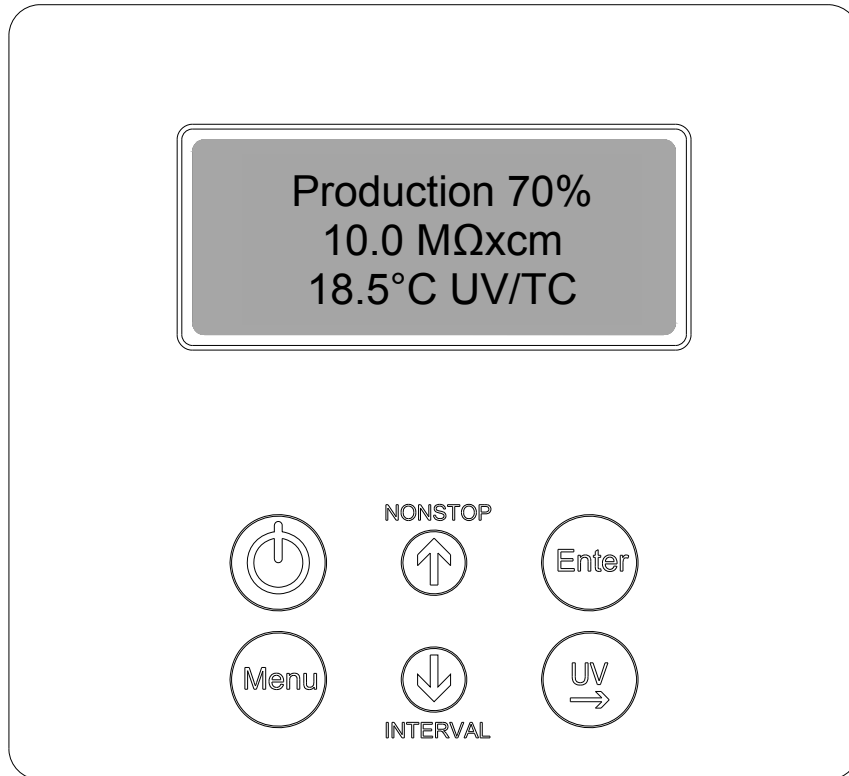

Switches the system on or off

NONSTOP



Increases a value on display



Confirms the value shown in a menu point



Switches the menu to the next menu point



Decreases a value on display

INTERVAL



Switches the UV-lamp on or, in the menu, allows you to select the position in a number that you wish to change



## 13. System Control

### General information

When the ON/OFF key is pressed, the system starts running either in the operating state or the stand-by state, depending on the float switch.

The operating state and the volume contained in the tank is shown in line 1 of the display. Further to this, the volume contained in the tank is indicated in line 1 and the value of the permeate conductivity measured is shown in line 2.

Should a fault occur, a fault message is given out across the potential-free output and displayed in line 4. Should several faults occur at once, they are alternately displayed.

### 13.1 User menu

All measured values, operating times and limiting values that are relevant for the user can be read or set in this menu.

A press on the menu-key brings you into this menu. Each further press on the menu-key moves you from one menu point to the next.

Settings can be changed with the arrow keys. When the correctness of a value is confirmed by pressing Enter, this also takes you to the next menu point.

To simplify changing settings, a press on the UV-key allows you to select the position at which you wish to change a number, and the arrow keys can be used to set a number from 0-9 at each individual position.

#### 13.1.1 Permeate conductivity:

A single press on the menu-key allows the feedwater conductivity to be read and the limiting value of the permeate conductivity to be changed. Should the limiting value be exceeded, then the "Lim. Val. Permeate" message flashes in the 4<sup>th</sup> line of the display (measuring point LF2)

**Limiting value setting range:** 0.1 – 150.0  $\mu\text{S}/\text{cm}$   
**Basic setting:** 0.020  $\text{M}\Omega\text{xcm}$

With settings above 150.0  $\mu\text{S}/\text{cm}$ , the limiting value is switched off and the word „Off" appears in the display.

The display shows:

Permeate 0.083 $\text{M}\Omega\text{xcm}$ Lim.val.permeate 50,0 $\mu\text{S}/\text{cm}$
--

### 13.1.2 Pure water limiting value:

A second press on the menu-key allows the high purity water limiting conductivity value to be set in this menu. Should the limiting value be exceeded, then the “*Lim. Val. Pure w.*” Message is displayed (measuring point LF1)

**Limiting value setting range:** 0.055 – 9.999  $\mu\text{S}/\text{cm}$   
**Basic setting:** 0.50  $\text{M}\Omega\text{cm}$

Settings above 9.999  $\mu\text{S}/\text{cm}$  result in the limiting value being switched off. The word “*Off*” appears in the display.

The display shows:

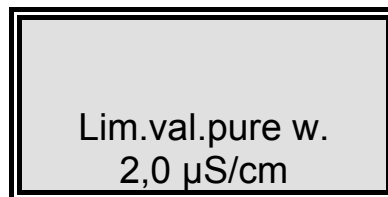

### 13.1.3 Operating hours:

A third press on the menu-key allows the operating hours of the UV-lamp and the reverse osmosis pump to be displayed in this menu. The UV-lamp operating hours counter registers the total length of time for which the lamp was switched on. When the maximum operating time is reached, the “*UV time*” fault message is triggered. The limiting value can be set in the OEM menu.

The operating hours of the reverse osmosis pump does not have a limiting value.

The display shows:

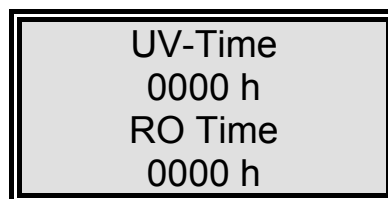

#### 13.1.4 Pretreatment operating hours:

A fourth press on the menu-key brings the operating hours of the pre-treatment cartridge to display in this menu.

The limiting value for this operating time is set in the UV menu. The fault message that is displayed when the limiting value is exceeded is "*Pretreatment*".

The operating hours of the pre-treatment are counted when the reverse osmosis pump is running.

The display shows:

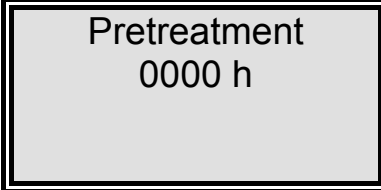

Pretreatment  
0000 h

#### 13.1.5 Cleaning:

A fifth press on the menu-key allows cleaning to be carried out whenever there is a need for it. The cleaning process is triggered by pressing the Enter-key. The pump then starts and the inlet solenoid valve and the rinsing solenoid valve open for a period of 60 seconds.

During cleaning, no faults or measured values are displayed. When the cleaning process has finished, the system returns to the last operating state (operation or stand-by)

The remaining cleaning time is displayed while cleaning takes place.

The display shows:

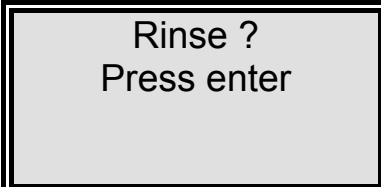

Rinse ?  
Press enter

During cleaning, the display shows

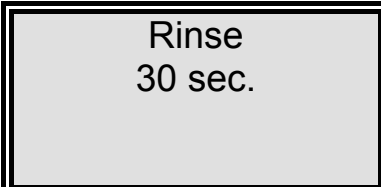

Rinse  
30 sec.

**13.1.6 Disinfection :**  
**(This function is not active in this system)**

The display shows:



Disinfection  
Press enter

**13.1.7 Fault storage:**

A seventh press on the menu-key calls the fault storage inquiry. Confirmation of this with Enter allows the fault storage to be examined. The display shows two faults at once, each with time and date. Pressing an arrow key allows previous or following faults to be displayed. Pressing the menu-key or the Enter-key returns the system to the last operating state.

The display shows:



Error history  
Press enter

The display of the fault storage shows:

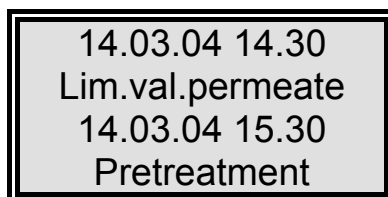

14.03.04 14.30  
Lim.val.permeate  
14.03.04 15.30  
Pretreatment

### 13.1.8 Unlocking the system:

An eighth press on the menu-key brings you to the “Code” menu. To prevent unauthorized access to the settings in the system control, changes to the settings can only be carried out when the correct code from the assignment Table that follows is entered and confirmed with Enter. The unlocking remains active for 5 minutes. Each access via the code is typed out by the printer (RS 232), complete with date, time and shortened code number. (« Code 150 » = Code 0001, « Code 250 » = Code 0002 etc.)

The display shows:



Code numbers can be assigned to individual persons according to the Table that follows. Remove this page from the Operating Instructions and store it where it is safe from unauthorized viewing.

## Assignment Table for persons authorized to unlock the system control

Code-No.	Printed out	Person
150	0001	
250	0002	
350	0003	
450	0004	
550	0005	
650	0006	
750	0007	
850	0008	
950	0009	

## 13.2 OEM-menu

Basic settings and limiting values can be changed in this menu.

To make changes in the OEM-menu, the system control must previously be unlocked (see 12.1.8)

Calling the OEM-menu:

Simultaneously pressing the INT-key and the Nonstop-Key calls the OEM-menu. Following this, the prompt "*OEM-menu Press enter!*" appears. When this is confirmed with Enter, the first menu point can be worked on. To simplify changing settings, press the UV-key to select the position at which you want to change a number. Using the arrow keys now allows a number from 0 to 9 to be entered at that position.

A press on the menu-key takes you to the next menu point.

The OEM-menu prompt display shows:

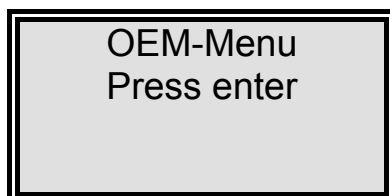

### 13.2.1 Maximum temperature:

**A single press on the menu-key:**

The maximum temperature the system can be exposed to can be set in this menu.

When this temperature is exceeded, the "Max. Temp." Fault message is triggered.

Settings above 50°C cause the limit evaluation to be suppressed, and the word "Off" appears in the display. This is shown in the fourth line of the display.

**Basic setting:** 50 °C

**Setting range:** 1 – 50 °C

The display shows:

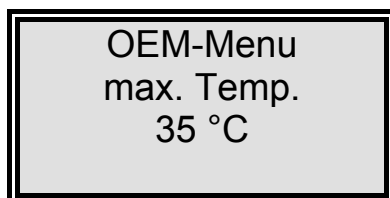

**13.2.2 Disinfection time:****A second press on the menu-key:****(This function is not active in this system)**

The display shows:

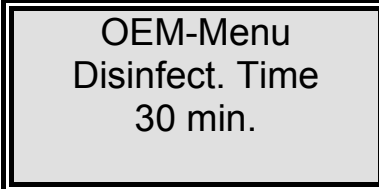

OEM-Menu  
Disinfect. Time  
30 min.

**13.2.3 Recirculation time:****A third press on the menu-key:**

The recirculation time is set in this menu.

**Basic setting:** 15 min.**Setting range:** 1 – 30 min.

The display shows:

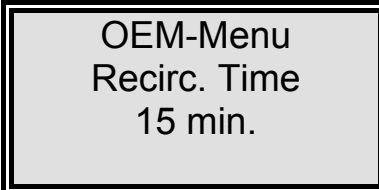

OEM-Menu  
Recirc. Time  
15 min.

**13.2.4 Rinsing time:****A fourth press on the menu-key:**

The rinsing time is set in this menu.

**Basic setting:** 0,5 sec.**Setting range:** 0.1 – 30 sec.

The display shows:

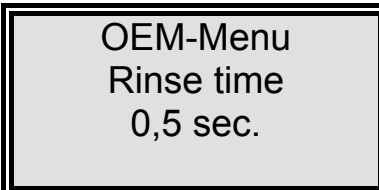

OEM-Menu  
Rinse time  
0,5 sec.

### 13.2.5 Rinse interval time

A fifth press on the menu-key:

A fifth press on the menu-key:

The rinse interval time is set in this menu. A rinse is carried out for this length of time when the operating state is changed, between stand-by and operation and every 12 hours.

**Basic setting:** 2 sec.

**Setting range:** 1 – 30 sec.

The display shows:

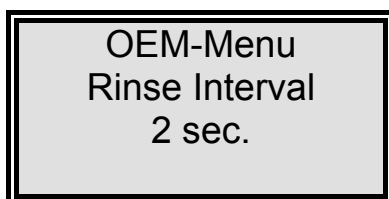

OEM-Menu  
Rinse Interval  
2 sec.

### 13.2.6 Real time clock:

A sixth press on the menu-key:

The real time clock is set in this menu.

**Basic setting:** The actual date

**Setting range:** 1 – 12 month, 1 – 31 day, 0 – 24 h, 0 – 60 min.

The display shows:

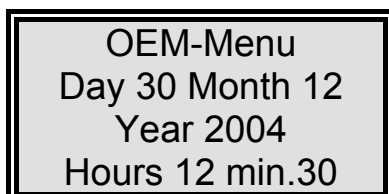

OEM-Menu  
Day 30 Month 12  
Year 2004  
Hours 12 min.30

### 13.2.7 Sending interval:

A seventh press on the menu-key:

The sending interval for transmission of measured values and fault messages to the RS 232 interface is set in this menu..

**Basic setting:** 8 hours

**Setting range:** 0.5 – 12 hours

The display shows:

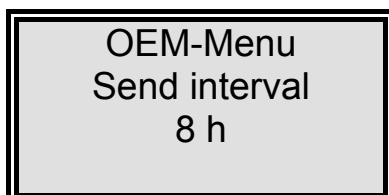

OEM-Menu  
Send interval  
8 h



**13.2.8 Language:****An eighth press on the menu-key:**

The language in which texts are to be displayed is set in this menu. Choice of English, German or French.

**Basic setting: English or German (Deutsch)**

The display shows:

**13.2.9 Switching units:****A ninth press on the menu-key:**

In this menu, a choice can be made as to whether the specific electric resistance or the conductivity is to be displayed.

**Basic setting:** Resistance  $M\Omega\text{cm}$   
**Setting range:** Resistance  $M\Omega\text{cm}$ ,  
Specific electrical resistance  $M\Omega\text{ cm}$

The display shows:

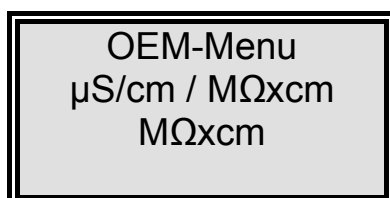
**13.2.10 Switch off temperature compensation:****A tenth press on the menu-key:**

**Basic setting:** On  
**Setting range:** On, Off

The display shows:

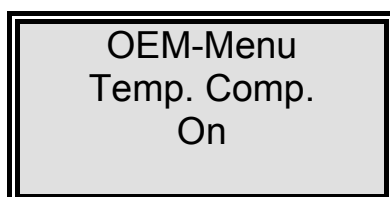

**13.2.11 Adjusting the circuit hysteresis of the float switch:****An eleventh press on the menu-key:****Basic setting:** Off: 100 %  
On: 70 %**Setting range:** Off: 25 – 100 %  
On: 0 – 70 %

With a setting over 100 % for the upper switching point, the display of the tank level is switched off. The setting here is so according to whether an analogue or a digital float switch is installed.

The display shows:

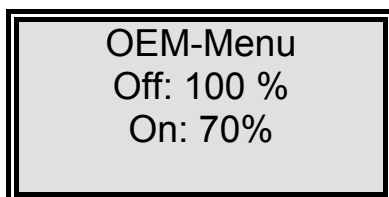

OEM-Menu  
Off: 100 %  
On: 70%

**13.2.12 Programme choice, TII UV, RO:****A twelfth press on the menu-key:**

In this menu, the equipping grade of the system can be set, to differentiate between TII UV and RO.

**Basic setting: TII UV**

The display shows:

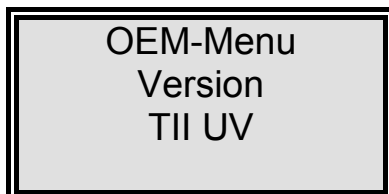

OEM-Menu  
Version  
TII UV

**13.2.13 Entering the type and serial number of the system:**

In this menu, the type and serial number of the system can be entered, both of which are then given as headline on every print-out. The following types of systems can be given: Pacific-RO, Pacific-TII, Pacific-TII UV, Pacific-AFS.

The display shows:

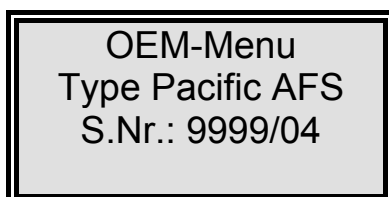

OEM-Menu  
Type Pacific AFS  
S.Nr.: 9999/04

## 14. Maintenance

Regular maintenance of your system safeguards the value of it. We recommend that you close a service contract with the Service company responsible for your area. You then have the certainty of a high operational safety and reliability.

### NOTE!

To ensure that your system will work reliably for a long time, it **must** be checked, serviced and cared for at regular intervals as detailed in these operating instructions! For this reason, the operating instructions must be readily available to operating and maintenance staff at all times, and be carefully followed!

Any maintenance work which should become necessary during the validity of the guarantee is only to be carried out by a service professional which is expressly authorized to do this.

The assigned operating staff is committed to carry out the weekly checks. During the agreed term of validity of the guarantee, maintenance is to be carried out weekly in accordance with the maintenance record sheet supplied with the operating instructions.

Calibration of the conductivity measurement is **only** to be carried out and recorded by service.

The cleaning of supply tanks, piping, filter housings etc. Is performed for reasons of hygiene and has no effect on the technical condition. These components need only be cleaned when algae or slime are detected inside them.



**Checks or maintenance work are only to be carried out on electrical equipment (switchbox, level switch) after having ensured that the equipment is not live.**

## 14.1 Maintenance intervals

Consumable materials are to be replaced at the intervals given in the following Table or when there is a drop in performance:

Material	Flow chart no.	Article no.	Interval*
Pretreatment 09.4001 Prefilter/Hardness stabilization	F1	06.5204	6 Months
Pretreatment 09.4000 Prefilter Hardness stabilization	F1	06.5201 06.5452	6 Months 6 Months
Filter cartridge	F3	09.4011/09.4012	12 Months

\*Please keep in mind that the life of your consumables is directly dependent on the quality of the feed water and the amount of water used daily. The interval is contingent on the feedwater quality so that a shorter one may be necessary.

## 14.2 Cleaning the membrane

### Rinsing out preserving liquid:

According to the mode of delivery of the system, it may be supplied filled with a solution containing a preservative.

Should this be the case, when the system is first put into operation, the permeate obtained after switching to production must be discarded for at least 3 – 4 hours.

To do this, each time the tank is full, open the valve at your drawing-off point and lead the purified water to drain.

### Cleaning the membrane:

The automatic flushing lengthens the service life of your reverse osmosis module by sweeping coarse particles and other contaminants away from the surface of the reverse osmosis membrane. The flushing phases so ensure maximum service life and optimal purified water quality.



Keep your high purity water system switched on over the weekend and during holiday times. Only then can the 12 hour rinse take place and avoid the bacterial growth on the reverse osmosis membrane that could occur during standstill.

Should there be a reduction in the flow rate because inappropriate pre-treatment has caused blockage of the reverse osmosis module, it is often possible to recondition the module. Such reconditioning of the module is only to be carried out by authorized service personnel responsible for your area, or is to be returned to the manufacturer of the reverse osmosis module. The module must not be subjected to frost during transport.

### 14.3 Changing the reverse osmosis membrane

Pacific 3, 7, 12 TII / TII UV: 1 RO-Membrane  
Pacific 20 + 40 TII / TII UV: 2 RO-Membranes

Ansicht von hinten - ohne Rückwand  
Back view, with back panel removed

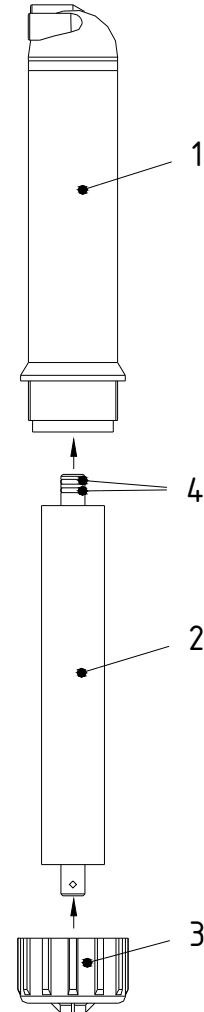
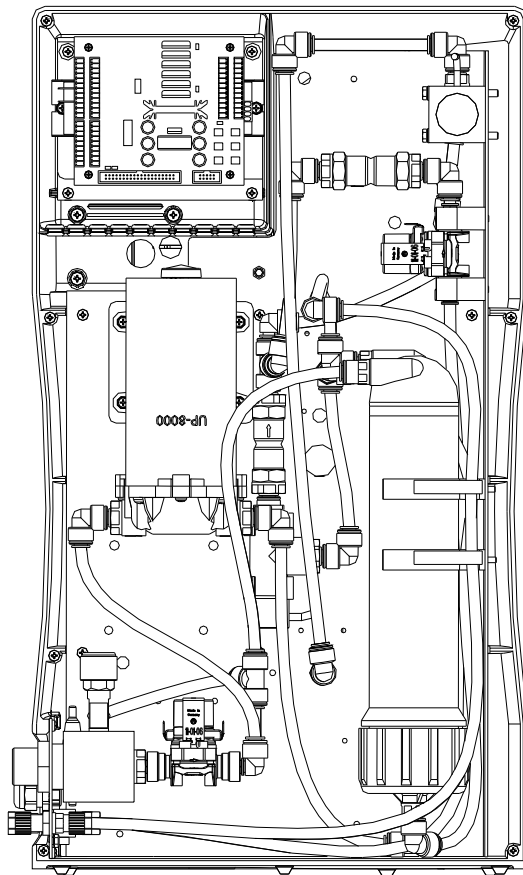

- Disconnect the line plug
- Undo all hose connections to the pressure tube (1) of the reverse osmosis module.
- Remove the pressure tube from the holding clamps.
- Open cap nut (3) on the pressure tube and draw out the reverse osmosis membrane (2).
- Insert the new reverse osmosis membrane in the pressure tube, with the two O-rings on the permeate tube (4) foremost as indicated by the arrow.
- Install the reverse osmosis module in the reverse succession.



**Incorrect insertion of the reverse osmosis membrane would result in immediate damage to it.**

## 14.4 Changing the filter cartridge

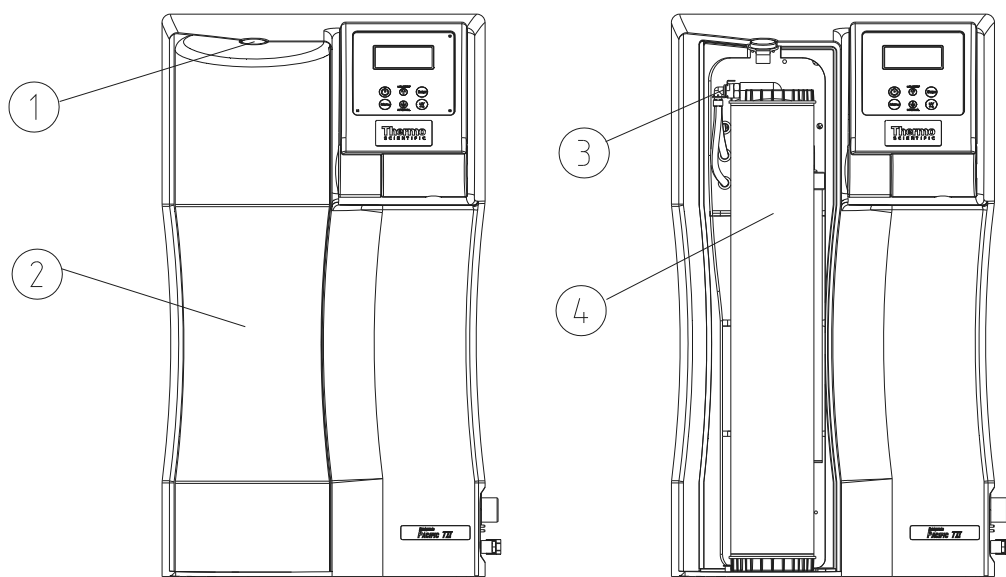

**For changing the filter cartridge, proceed as follows:**

1. Switch off your device and turn off the feedwater supply.
2. Press pressure knob (1) to unlock and remove cover (2).
3. Release filter cartridge (4) quick connect coupling (3).
4. Remove exhausted filter cartridge (4) and replace it with a new one.
5. Fit the quick connect coupling (3) back onto the new filter cartridge (4).
6. Replace the cover (2) and listen to ensure it clicks on pressure knob (1).
7. Turn on the feedwater supply and switch your device on again.
8. Your device is now ready for operation

## 14.5 Disinfection



**Your system should be cleaned and disinfected at least once a year to eliminate any bacteria that are possibly in the system. We recommend that you carry out cleaning and disinfection shortly before the time that the filter cartridge must to be replaced.**

Use cleaning solutions as follows:

MICRO-Chlor Granulate, 1 box, article no. 09.2202 (Europe only)

Cleaning Solution, 1 syringe, article no. CMX 25 (US-market only).



**Please observe the information given in the safety data sheet supplied with Micro-Chlor disinfectant to avoid possible health hazards!**



**Disinfect the reverse-osmosis or the tank/ recirculation with the used filter cartridge. Replacement these after the disinfection against a new filter cartridge.**

### Disinfection of the reverse-osmosis

1. Switch the Pacific system off.
2. Shut off the supply of feedwater to the system and release pressure from the feed line.
3. Open the housings of the pre-treatment, take the filter cartridges out and pour the contents of a box respectively a syringe of the cleaning solution into it. Tightly screw-close the housings again.
4. Re-open the feedwater supply.
5. Switch the system on and let it run for 1 hour in normal operation.
6. Switch the system off and empty the tank to drain.
7. Shut off the supply of feedwater to the system and release pressure from the feed line.
8. Open the housings of the pre-treatment put the new filter cartridges into the empty housings of pre-treatment and screw down the housings.
9. Now change the filter cartridge as described in the Operating Instructions for the system and, if necessary, the reverse osmosis membrane.

10. Open the supply of feedwater.
11. Switch the system on, produce two complete tank fillings of water and discard the water that is produced.



**Before dispensing water from the system, let water run out for approx. 15 minutes. The system is then again ready for use.**

### **Disinfection of the tank/ recirculation**

1. Switch the Pacific system off.
2. Shut off the supply of feedwater to the system and release pressure from the feed line.
3. Half empty the tank belonging to the system, screw the lid off and pour the contents of a box respectively a syringe of the cleaning solution into it. Close the lid again.
4. Re-open the feedwater supply.
5. Switch the system on and let it run for 1 hour in normal operation.
6. Switch the system off and empty the tank to drain.
7. Produce two complete tank fillings of water and discard the water that is produced.
8. Now change the filter cartridge as described in the Operating Instructions for the system and, if necessary, the reverse osmosis membrane.
9. Replace the filter elements in the pre-treatment (if not already with the „Disinfection of the reverse-osmosis” happen).
10. Fill the tank completely once and discard the water produced from this tank filling.



**Before dispensing water from the system, let water run out for approx. 15 minutes. The system is then again ready for use.**

**Use after disinfecting the reverse-osmosis and the tank/ recirculation always new filter elements in the pre-treatment.**

### **Replacement parts:**

Filter cartridge  
RO-membrane

Article no.: 09.4011  
Article no.: 22.0046



## 15. Waste disposal

When the packaging is no longer needed it can be disposed of as household waste.

Systems are in conformity with EEC Guideline 2002/95/EC

The system is not to be thrown away as household waste but must be properly disposed of. It can be returned to the manufacturer for safe disposal according to EEC Guideline 2002/96/EC. We therefore request our customers in Germany and other member States in the European Economic Area to contact our local service centre or our headquarters:

Thermo Electron LED GmbH  
Stockland 3  
D-56412 Niederelbert, Germany

WEEE-Reg.-no.: DE 12471402

In countries outside of the European Economic Area, please contact your local authorities or waste disposal company.

## 16. Trouble shooting

Fault	Cause	Remedy
Cannot be started	- No supply of power	- Connect to the power supply
Water cannot be drawn off	- Feedwater tap is closed - Feedwater and rinse water connections mixed up - Feedwater pressure < 1.5 bar	- Turn the water tap on - Reverse the connections - Increase feedwater pressure
Conductivity value too high	- Exchange capacity is exhausted	- Replace the filter cartridge
Controls no longer react	- Incorrect operation	- Unplug line plug for 5 sec., then plug back in
Water leaks out	- Hose connection leaks - Feedwater pressure > 6 bar	- Check hose connection and stop leak - Install pressure reducer
Permeate flow is too low (-15%)	- RO-Membrane blocked - Initial pressure too low - Internal pressure too low - Fluctuating feedwater temperature	- Clean the RO-membrane - Increase initial pressure - Re-adjust the pressure reducer
Wrong time or date	- Time difference - Time change	- Reset time and date
Wrong language	- Wrong language set	- Correct the language setting
Fault message: "Lim. Val. Permeate"	- Permeate conductivity too high - Limiting value set too low	- Check the pre-treatment - Check and adjust the limiting value setting
Fault message: "Lim. Val. pure w."	- Filter cartridge exhausted - Limiting value set too low	- Replace the filter cartridge (Art.-no.: 09.4011) - Check/adjust limiting value

<p>Fault message: <i>"UV time"</i></p>	<ul style="list-style-type: none"> <li>- The max. Operating hours of the UV-lamp have been exceeded</li> </ul>	<ul style="list-style-type: none"> <li>- Replace the UV-lamp (Art.-no. 09.4002) and reset the operating hours counter</li> </ul>
<p>Fault message: <i>"Pretreatment"</i></p>	<ul style="list-style-type: none"> <li>- The max. Operating hours of the pre-treatment have been exceeded</li> </ul>	<ul style="list-style-type: none"> <li>- Replace the pre-treatment and reset the operating hours counter</li> </ul>
<p>Fault message: <i>"Meas. Cell LF1"</i></p>	<ul style="list-style-type: none"> <li>- Break in the measuring cell cable</li> <li>- System control defect</li> <li>- Conductivity of high purity water outside the measuring range</li> </ul>	<ul style="list-style-type: none"> <li>- Replace the measuring cell</li> <li>- Replace the system control</li> <li>- see "Resistance &lt; 18.2 MΩxcm"</li> </ul>
<p>Fault message: <i>"Meas. Cell LF2"</i></p>	<ul style="list-style-type: none"> <li>- Break in the measuring cell cable</li> <li>- System control defect</li> <li>- Conductivity of the feedwater outside the measuring range</li> </ul>	<ul style="list-style-type: none"> <li>- Replace the measuring cell</li> <li>- Replace the system control</li> <li>- see "Feedwater limiting value"</li> </ul>
<p>Fault message: <i>"Temp. Meas. Cell"</i></p>	<ul style="list-style-type: none"> <li>- Break in the measuring cell cable</li> <li>- System control defect</li> </ul>	<ul style="list-style-type: none"> <li>- Replace the measuring cell</li> <li>- Replace the system control</li> </ul>

The address to contact when your system requires service:

**Overview of Thermo Scientific International Sales Organization****Postal address USA:**

Thermo Scientific  
275 Aiken Road  
Asheville, NC 28804  
USA

**Enquiries from USA/Canada**

**Sales:** +1 866 984 3766  
**Service:** +1 800 438 4851

**Enquiries from Latin America**

**Sales:** +1 866 984 3766  
**Service:** +1 866 984 3766

**Enquiries from Asia:****China**

**Sales:** +86 10 8419 3588  
**Service:** Toll free 8008105118  
Support Mobile 4006505118 or +86 10 8419 3588

**India**

**Sales:** +91 22 6716 2200  
**Service:** Toll free 1 800 22 8374 or +91 22 6716 2200

**Japan**

**Sales:** +81 45 453 9220  
**Service:** +81 45 453 9224

**Enquiries from the Rest of Asia/Australia/New Zealand**

**Sales:** +852 2885 4613  
**Service:** +65 6872 9720

**Enquiries from Countries not listed / Rest of EMEA**

**Sales:** +49 6184 90 6940 or +33 2 2803 2000  
**Service:** +49 6184 90 6940

**Enquiries from Europe:****Austria**

**Sales:** +43 1 801 40 0  
**Service:** +43 1 801 40 0

**Belgium****Sales:** +32 53 73 4241**Service:** +32 53 73 4241**Finland/Nordic/Baltic countries****Sales:** +358 9 329 100**Service:** +358 9 329 100**France****Sales:** +33 2 2803 2180**Service:** +33 825 800 119**Germany:****Postal Address Germany:**

Thermo Electron LED GmbH

Robert-Bosch-Straße 1

D – 63505 Langenselbold

**Phone****Sales** Toll free 0800 1 536 376

or +49 6184 90 6940

**Service** Toll free 0800 1 112110

or +49 6184 90 6940

**E-Mail** [info.labequipment.de@thermoftsher.com](mailto:info.labequipment.de@thermoftsher.com)**Italy****Sales** +39 02 95059 341**Service** +39 02 95059 250**Netherlands****Sales** +31 76 579 5555**Service** +31 76 579 5639**Russia/CIS****Sales** +7 812 703 4215**Service** +7 812 703 4215**Spain/Portugal****Sales** +34 93 223 0918**Service** +34 93 223 0918**Switzerland** +41 44 454 1212**Service** +41 44 454 1212**UK/Ireland****Service** +44 870 609 9203**Sales** +44 870 609 9203

## 17. Replacement parts for Pacific TII

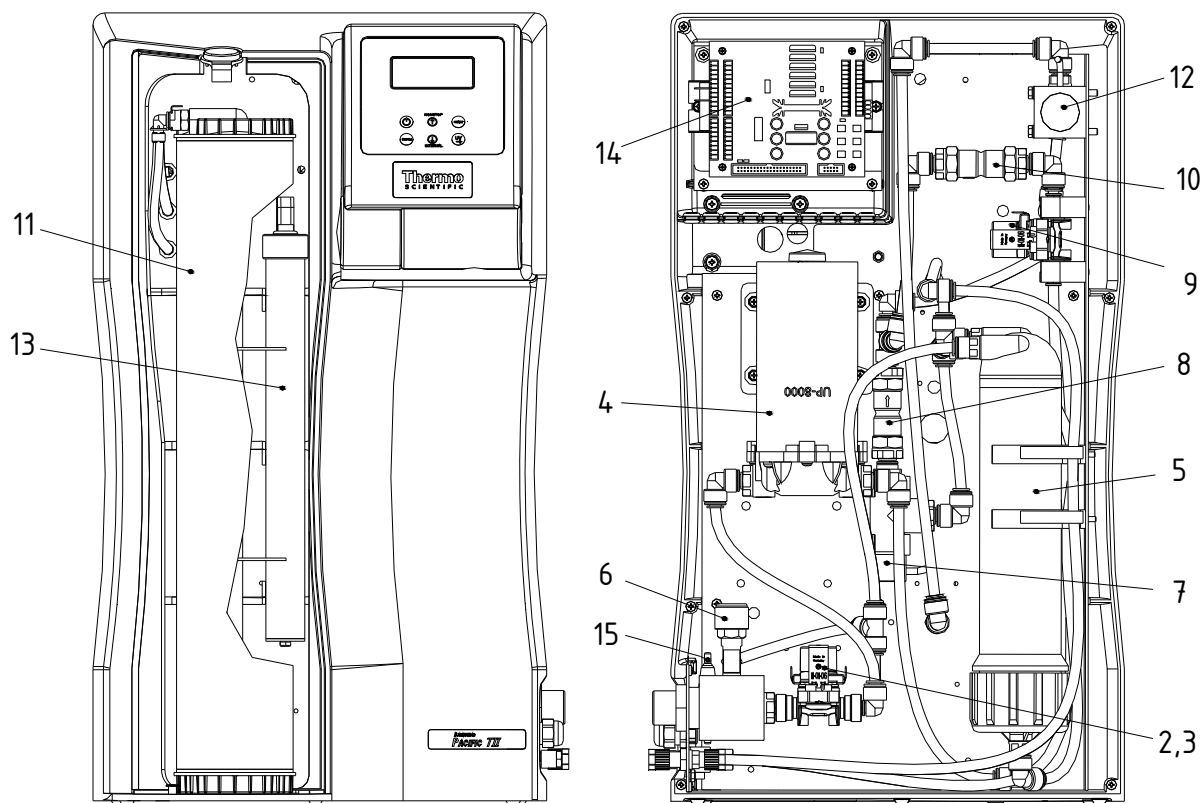

Pos.	R+I No.	Designation	Article no.
2	V2	Inlet solenoid valve	50131190*
3	V4	Rinsing solenoid valve	50131190*
4	A-P1	Pressure boosting pump ( by 3-20 TII / TII UV) Pressure boosting pump ( by 40 TII / TII UV)	19.0050* 19.0050*
5	A-F2	Reverse osmosis membrane (by 3-12 TII / TII UV 1x, by 20 TII / TII UV 2x) Reverse osmosis membrane (by 40 TII / TII UV 2x Reverse osmosis pressure tube (by 20+40 TII / TII UV 2x)	22.0046* 22.0087* 50133990
6	V3	Pressure hold valve	15.0060
7	QIA300	Permeate conductivity measuring cell	16.0126
8	V5	Check valve	15.0009
9	V7	Recirculation solenoid valve	50131190*
10	V6	Check valve	15.0019
11	A-F3	Filter cartridge	09.4011
12	QIA301+TIA500	High purity water conductivity measuring cell	50133992
13	A-UV1	UV- replacement lamp	50134462
14		Electronic system control, complete	50132019
15		Fuse holder for glas tube fuse 5x20mm	50133979
		Glas tube fuse 5x20mm, 3.15A, slow	50131758
		Glas tube fuse 5x20mm, 2 A, nimble (only TII 40/TII 40 UV)	50134191
		Table power unit 24V DC (not shows)	50134196
		Table power unit 48V DC (not shows, only TII 40/TII 40 UV)	50134184

\* Wearing part

## 18. Replacement parts for the optional tank

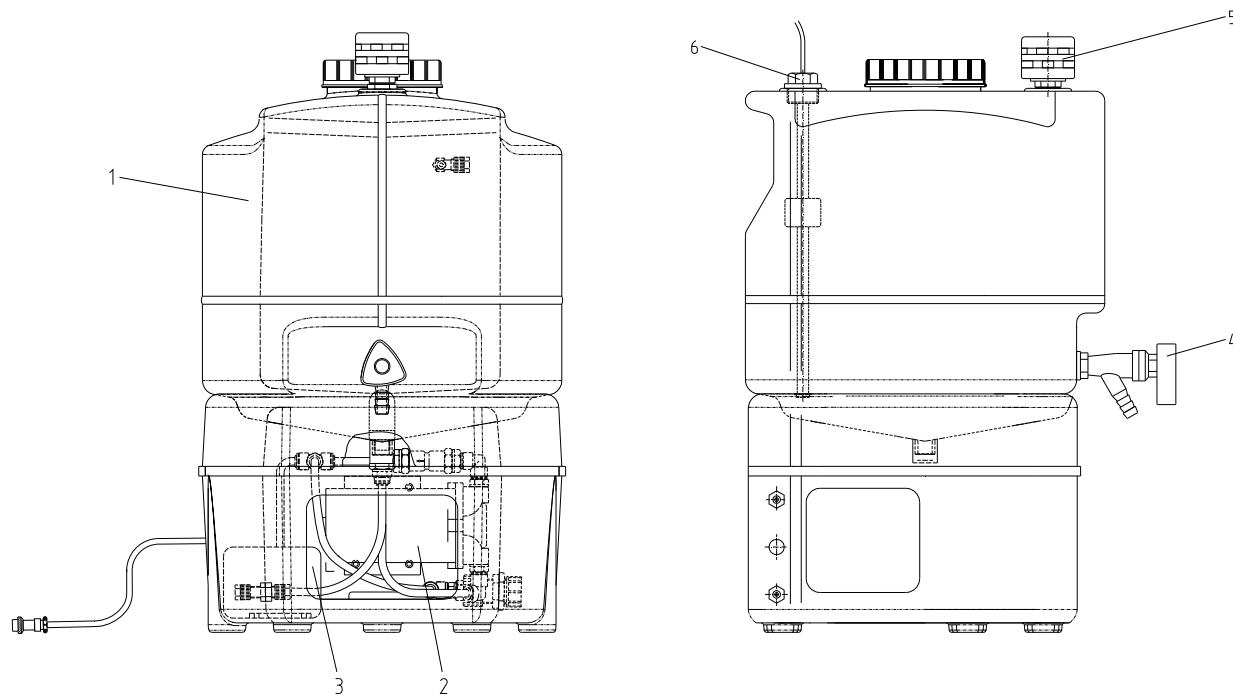

Pos.	R+I No.	Description	Article no.
1	A-B1	Tank, 30 L Tank, 60 L Tank 100 L	18.0114 18.0115 18.0159
2	A-P2	Pressure pump	19.0046*
3	PS200	Pressure switch	15.0058*
4	V9	Dispensing valve	14.0250
5	A-F4	Sterile venting filter	06.5003
6	LIS100	Float switch for 30 L tank Float switch for 60 L tank	16.0303 16.0304

\* Wearing part

We ask for your understanding that we must declare the guarantee for this system to be invalidated should replacement parts, accessories or consumables from other manufacturers be used, as we have no influence on their quality or appropriateness.

## 19. Consumables

Designation	Parts supplied	Article no.
Filter cartridge set	2 x Filter cartridges with Nuclear-grade resins	09.4012
UV- replacement lamp	1 x UV- lamp	50134462
Reverse osmosis membrane	1x at Pacific 3, 7, 12 TII / TII UV, 2x at 20 TII / TII UV 2x at Pacific 40 TII / TII UV	22.0046 22.0087
Sterile venting filter	1 x Sterile venting filter, 0.2 µm	06.5003
Prefilter 1 µm (option)	1 x Filter cartridge 1 µm	06.5101
<b>For pretreatment 09.4001:</b> Filter cartridge 5 µm and Hardness stabilizer, 10"	1 x Filter cartridge 5 µm, and Hardness stabilizing cartridge, 10"	06.5204
<b>For pretreatment 09.4000:</b> Combination cartridge with: activated carbon, 10" Hardness stabilizer, 10"	1 x Activated carbon cartridge, 5 µm, 10" 1 x Hardness stabilizing cartridge, 10"	06.5201 06.5452

## 20. Accessories

Designation	Parts supplied	Article no.
Pretreatment system	1x activated carbon combi cartridge 5µm, 5" 1x hardness stabilizing cartridge 5"	09.4001
Pretreatment system	1x activated carbon combi cartridge 5µm, 10" 1x hardness stabilizing cartridge 10"	09.4000
Pretreatment system	1x FK- Filter cartridge 1 µm, 10"	09.4003
Storage tank 30 L	1x Storage tank 30 litre incl. pressure pump and recirculation	06.5032
Storage tank 30 L	1x Storage tank 30 litre without. pressure pump and recirculation	06.5033
Storage tank 60 L	1x Storage tank 60 litre incl. pressure pump and recirculation	06.5062
Storage tank 60 L	1x Storage tank 60 litre without. pressure pump and recirculation	06.5063
Storage tank 100 L	1x Storage tank 100 litre incl. pressure pump and recirculation	06.5082
Storage tank 100 L	1x Storage tank 100 litre without pressure pump and recirculation	06.5083
CO <sub>2</sub> -Adsorber + Sterile venting filter	1 x Carbon dioxide trap for 30/60 L tank	06.5002
Sterile tank overflow	1 x Sterile tank overflow	06.5001
Sterile breather	1 x Sterile breather 0.2 µm	06.5003
UV-Immersion lamp for tank	1 x UV-Immersion lamp incl. time switch	06.5006
Disinfection agent MICRO-Chlor	Pack of 12 cans (only for Europe)	09.2202
Cleaning Solution, 1 syringe	(only for US-market)	CMX25
Qualification Manuel IQ, OQ		IOQDOCE50133915



## 21. Terminal assignment

### 21.1 Pacific TII 3-20/TII 3-20 UV (24V)

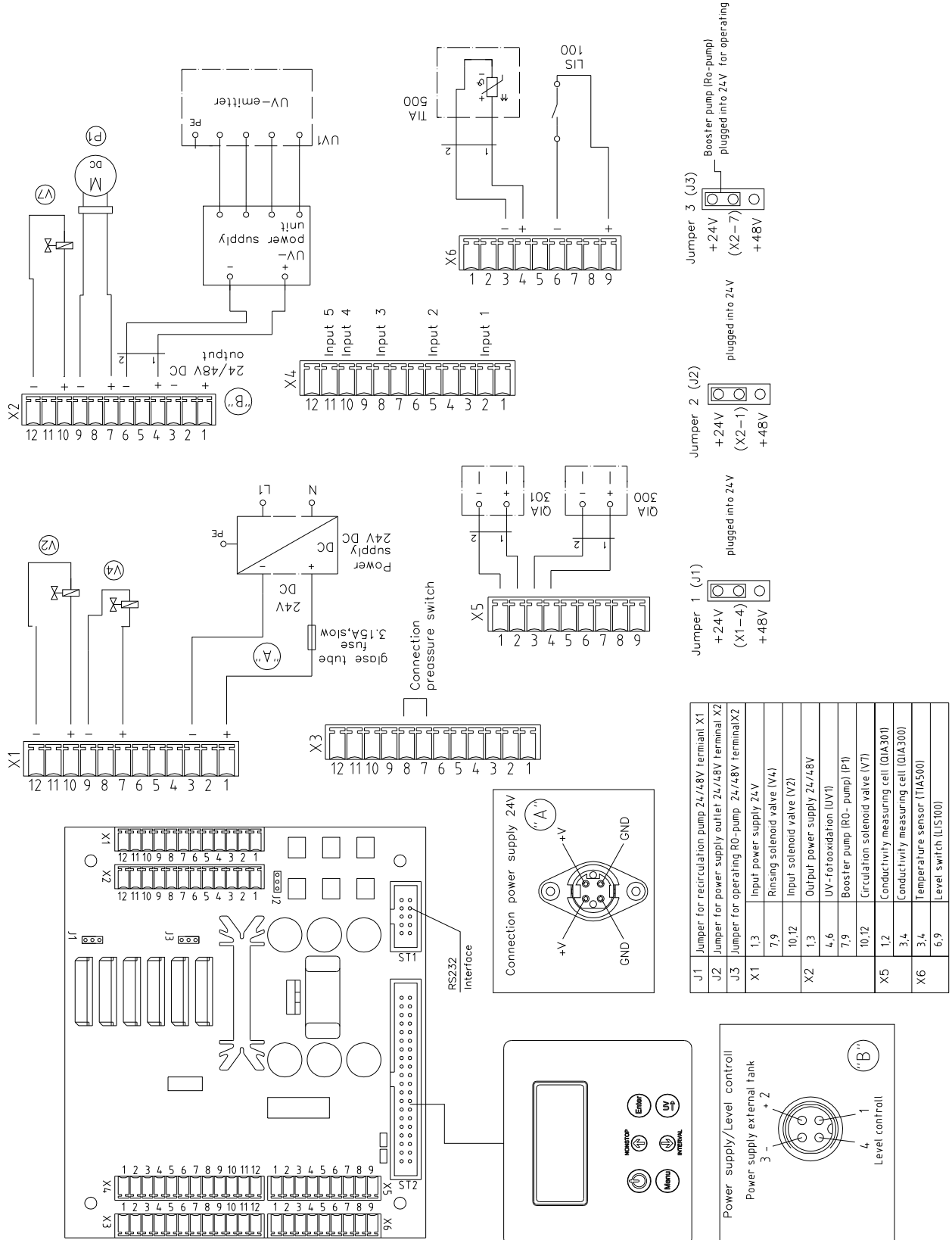

## 21.2 Pacific TII 40/TII 40 UV (48V)

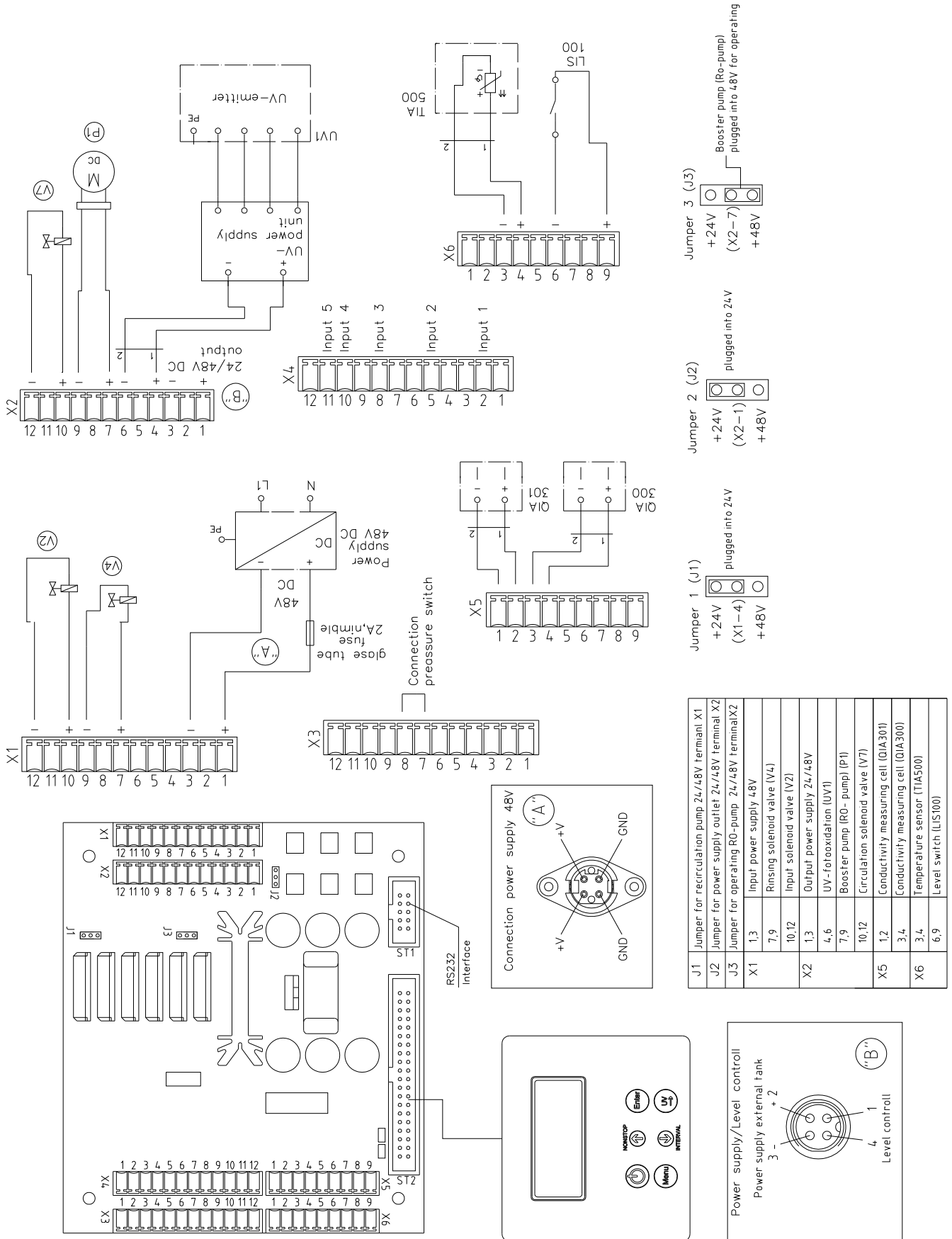

## 22. Maintenance record

(Please keep this record carefully. This is one of the conditions for maintaining the validity of the guarantee)

**Address of customer:**

**Location:**

\_\_\_\_\_

\_\_\_\_\_

\_\_\_\_\_

\_\_\_\_\_

\_\_\_\_\_

\_\_\_\_\_

**System type:**

\_\_\_\_\_

\_\_\_\_\_

\_\_\_\_\_

**Serial no.:**

**Year made:**

Date	Hardness of raw/softened water [°dH]	IES-resistance [MΩxcm]	Permeate flow [l/h]	Temperature [°C]	RO-resistance [MΩxcm]	Concentrate flow [l/h]	Last change of prefilter

Last change of hardness stabilizer	Last cleaning	Operating hours [h]	Notes	Signature

Any false entry is considered to be falsification of documents.

**The following points are to be considered to the safety device of the quality of the plant:**

- 1x weekly entered the measured value

## Contact Information Thermo Scientific

**North America:**

USA/Canada +1 866 984 3766 (866-9-THERMO)

**Europe:**

Austria +43 1 801 40 0, Belgium +32 53 73 42 41, France +33 2 2803 2180,  
Germany national toll free 08001-536 376,  
Germany international +49 6184 90 6940, Italy +39 02 95059 448,  
Netherlands +31 76 579 55 55, Nordic/Baltic/CIS countries +358 9 329 10200,  
Russia +7 812 703 42 15, Spain/Portugal +34 93 223 09 18,  
Switzerland +41 44 454 12 12, UK/Ireland +44 870 609 9203

**Asia:**

Australia +61 39757 4300, China +86 21 6865 4588 or +86 10 8419 3588,  
India toll free 1800 22 8374, India +91 22 6716 2200,  
Japan +81 45 453 9220, New Zealand +64 9 980 6700,  
Other Asian countries +852 2885 4613

**Countries not listed:** +49 6184 90 6940