

Register your instrument!  
[www.eppendorf.com/myeppendorf](http://www.eppendorf.com/myeppendorf)



## Eppendorf Eporator®

Operating manual

Copyright© 2016 Eppendorf AG, Germany. All rights reserved, including graphics and images. No part of this publication may be reproduced without the prior permission of the copyright owner.

Excel® and Microsoft® are registered trademarks of Microsoft Corporation, USA.

Eppendorf Eporator® is a registered trademark of Eppendorf AG, Germany.

Eppendorf® and the Eppendorf logo are registered trademarks of Eppendorf AG, Germany.

Registered trademarks and protected trademarks are not marked in all cases with ® or ™ in this manual.

**Table of contents**

<b>1</b>	<b>Operating instructions</b>	<b>5</b>
1.1	Using this manual	5
1.2	Danger symbols and danger levels	5
1.2.1	Hazard symbols	5
1.2.2	Degrees of danger	5
1.3	Symbols used	5
1.4	Glossary	6
<b>2</b>	<b>Safety</b>	<b>7</b>
2.1	Intended use	7
2.2	User profile	7
2.3	Information on product liability	7
2.4	Safety instructions on the device	7
2.5	Warnings for intended use	7
<b>3</b>	<b>Product description</b>	<b>9</b>
3.1	Delivery package	9
3.2	Product overview	9
3.3	Features	10
3.3.1	The principle of electroporation	10
<b>4</b>	<b>Installation</b>	<b>11</b>
4.1	Preparing installation	11
4.2	Selecting the location	11
4.3	Installing the instrument	11
<b>5</b>	<b>Operation</b>	<b>12</b>
5.1	Overview of operating controls	12
5.2	Recommendations for sample preparation	13
5.2.1	DNA preparation	13
5.2.2	Electroporation medium	14
5.2.3	Growth and preparation of cells	14
5.2.4	Temperature	14
5.3	Performing electroporation	15
5.3.1	Switching on the device	15
5.3.2	Inserting the cuvette	15
5.3.3	Electroporation	17
5.4	Regeneration of the cells	17
5.5	Determination of the transformation efficiency	17
5.6	Programs	18
5.6.1	Loading program	18
5.6.2	Saving program	18
5.7	Enhanced settings	18
5.8	Exporting data	19

<b>6</b>	<b>Troubleshooting</b> . . . . .	<b>21</b>
6.1	General errors . . . . .	21
6.2	Error messages . . . . .	22
6.2.1	Operational error . . . . .	22
6.2.2	Device error . . . . .	23
<b>7</b>	<b>Maintenance</b> . . . . .	<b>24</b>
7.1	Cleaning . . . . .	24
7.2	Replacing fuses . . . . .	24
<b>8</b>	<b>Technical data</b> . . . . .	<b>25</b>
8.1	Power supply . . . . .	25
8.2	Ambient conditions . . . . .	25
8.3	Weight/dimensions . . . . .	25
8.4	Interfaces . . . . .	25
8.5	Operating mode . . . . .	25
<b>9</b>	<b>Transport, storage and disposal</b> . . . . .	<b>26</b>
9.1	Storage . . . . .	26
9.2	Decontamination before shipment . . . . .	26
9.3	Transport . . . . .	26
9.4	Disposal . . . . .	27
<b>10</b>	<b>Ordering information</b> . . . . .	<b>27</b>
10.1	Eporator . . . . .	27
10.2	Accessories . . . . .	27
	<b>Certificates</b> . . . . .	<b>29</b>





## 1 Operating instructions

### 1.1 Using this manual

- ▶ Please read this operating manual completely before using the device for the first time.
- ▶ Please view this operating manual as part of the product and keep it somewhere easily accessible.
- ▶ When passing the device on to third parties, be sure to include this operating manual.
- ▶ If this manual is lost, please request another one. The current version can be found on our website [www.eppendorf.com](http://www.eppendorf.com).

### 1.2 Danger symbols and danger levels

#### 1.2.1 Hazard symbols

	Toxic substances		Electric shock
	Hazard point		Material damage

#### 1.2.2 Degrees of danger

The degree of danger is a part of a safety note and distinguishes the possible results of non-observance from each other.

<b>DANGER</b>	<i>Will</i> lead to severe injuries or death.
<b>WARNING</b>	<i>May</i> lead to severe injuries or death.
<b>CAUTION</b>	May lead to light to moderate injuries.
<b>NOTICE</b>	May lead to material damage.

### 1.3 Symbols used

Representation	Meaning
▶	Handling
1. 2.	Actions in the specified order
•	List:
<i>Text</i>	Name of fields in the software
	Useful information

## **1.4 Glossary**

### **A**

#### **Arcing**

If electrical voltage is applied between two parallel electrodes, a current flows in an evenly distributed layer. If the voltage exceeds a critical value, this layer contracts to a narrow circuit with high current density: an electric arc. The electrode material melts at this location, and explosive evaporation occurs. The cuvette can be destroyed under these conditions.

### **E**

#### **Electrical field strength**

Ratio of potential difference between two electrodes (in V) and the distance between these electrodes (electrode gap; in cm). However, this only applies if the electrical field is homogeneous, as with parallel plate electrodes (e.g., in Eppendorf Electroporation Cuvettes).

### **T**

#### **Time constant**

Time during which the voltage decreases to the value  $U/e$ .

**2 Safety**  
**2.1 Intended use**

The Eporator is intended for indoor use only and enables the simple and safe electroporation of bacteria and yeast strains using standard protocols.

**2.2 User profile**

The device and accessories may only be operated by trained and skilled personnel.

Before using the device, read the operating manual carefully and familiarize yourself with the device's mode of operation.

**2.3 Information on product liability**

In the following cases, the designated protection of the device may be compromised. Liability for any resulting property damage or personal injury is then transferred to the operator:

- The device is not used in accordance with the operating manual.
- The device is used outside of its intended use.
- The device is used with accessories or consumables which are not recommended by Eppendorf.
- The device is maintained or repaired by people not authorized by Eppendorf.
- The user makes unauthorized changes to the device.

**2.4 Safety instructions on the device**

Depiction	Meaning
	<b>WARNING</b> Follow the operating manual.

**2.5 Warnings for intended use**



**WARNING! Damage to health from toxic, radioactive or aggressive chemicals as well as infectious liquids and pathogenic germs.**

- ▶ Observe the national regulations for handling these substances, the biological security level of your laboratory, the Material Safety Data Sheets and the manufacturer's application notes.
- ▶ Wear your personal protective equipment.
- ▶ For comprehensive regulations about handling germs or biological material of risk group II or higher, please refer to the "Laboratory Biosafety Manual" (source: World Health Organization, Laboratory Biosafety Manual, in its respectively current valid version).



**WARNING! Lethal voltages inside the device.**

Touching parts which are under high voltage may cause an electric shock. An electric shock injures the heart and causes respiratory paralysis.

- ▶ Ensure that the housing is closed and undamaged.
  - ▶ Do not remove the housing.
  - ▶ Ensure that no liquid can penetrate into the device.
- Only authorized service staff may open the device.



**WARNING! Electric shock due to damage to device or mains cable.**

- ▶ Only switch on the device if the device and mains cable are undamaged.
- ▶ Only use devices that have been properly installed or repaired.
- ▶ In case of danger, disconnect the device from the mains supply. Disconnect the mains/power plug from the device or the earth/grounded socket. Use the designated isolating device (e.g., emergency switch in the lab).



**WARNING! Risk from incorrect supply voltage**

- ▶ Only connect the device to voltage sources which correspond to the electrical requirements on the name plate.
- ▶ Only use sockets with a protective earth (PE) conductor and suitable mains/power cord.



**CAUTION! Poor safety due to incorrect accessories and spare parts.**

The use of accessories and spare parts other than those recommended by Eppendorf may impair the safety, functioning and precision of the device. Eppendorf cannot be held liable or accept any liability for damage resulting from the use of incorrect or non-recommended accessories and spare parts, or from the improper use of such equipment.

- ▶ Only use accessories and original spare parts recommended by Eppendorf.



**NOTICE! Damage to device due to penetration of liquids.**

Liquid can enter the device during electroporation with cuvettes without lids.

- ▶ Only cuvettes with square lids may be used for electroporation.



### 3 Product description

#### 3.1 Delivery package

Quantity	Description
1	Eppendorf Eporator
1	Mains/power cord
1	Cuvette holder
1	Eporator operating manual

#### 3.2 Product overview

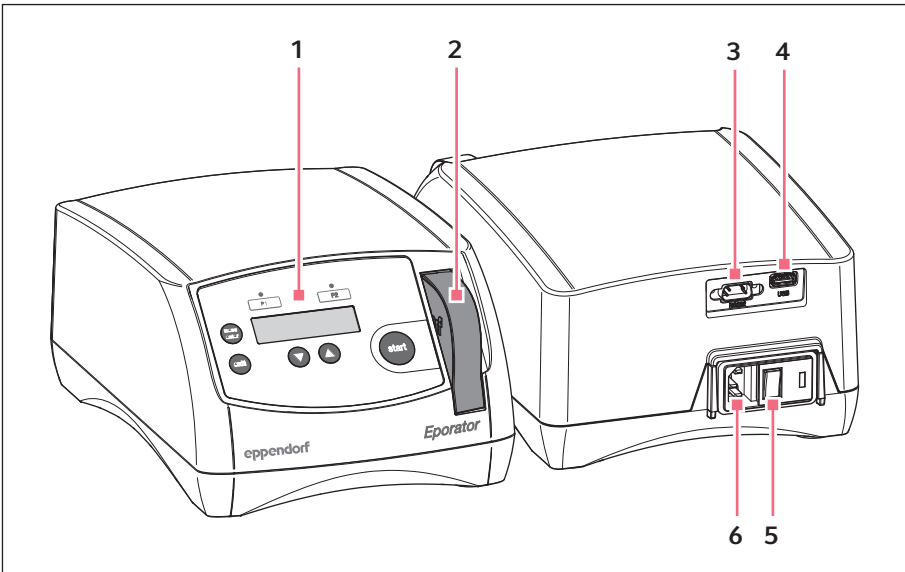

Fig. 3-1: Main Illustration

**1 Operating controls**

**2 Cuvette carrier**

In the cuvette shaft

**3 RS232 port**

Only for Technical Service

**4 USB port**

For inserting a USB stick

**5 Mains switch**

**6 Mains connection socket**

### 3.3 Features

The Eporator is inserted for the electroporation. It contains a capacitor that is discharged during electroporation using a resistor, thus generating an exponential discharge curve. A voltage between 200 V and 2500 V can be set. The exponential pulse generated by the Eporator is transferred to a disposable electroporation cuvette that contains the biological sample.

Unlike devices from other manufacturers, the Eporator features an integrated cuvette carrier with cuvette holder.

The construction of the Eporator minimizes the risk of short circuits. This also applies in the case of prohibited, high salt concentrations or maximum voltage. Even in the most unlikely situation of an electric arc in the cuvette, no bacterial suspension can escape from the cuvette and contaminate the device.

The Eporator is easy to operate. None of the device components require user-maintenance.

The experimental electroporation data can be saved on a USB stick and evaluated on a PC.

Application protocols for the electroporation of various bacteria and yeast strains can be found on the Eppendorf home page [www.eppendorf.com](http://www.eppendorf.com).

#### 3.3.1 The principle of electroporation

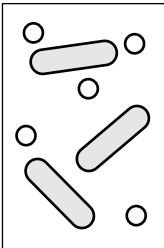

DNA and bacteria

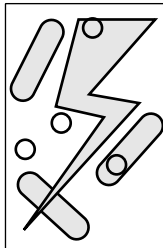

Electrical charge  
200 V - 2500 V;  
approx. 5 ms

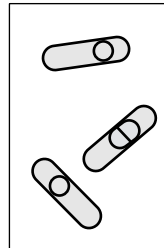

DNA in bacteria

With the electroporation method, macromolecules such as DNA can be placed in electrocompetent bacteria or yeast strains. In the process, small-volume samples with high resistance are exposed to pulses with very high electrical field strengths. The short, high voltage pulses create temporary holes or pores in the cell membrane, through which macromolecules, e.g. plasmid DNA, can diffuse into the cell. The holes close after removal of the electrical field and a period of regeneration. The inserted plasmid DNA can then be transcribed and replicated in the cell.

Unlike chemical transformation, electroporation is characterized by high transformation efficiency and simple execution.

## 4 Installation

### 4.1 Preparing installation



Retain the transport carton and packing material for subsequent safe transport or storage.

- ▶ Check all parts for any transport damage.

### 4.2 Selecting the location

Please select the location for the Eporator according to the following criteria:

- Mains connection (230 V/120 V/100 V) according to the name plate. This is located on the rear side of the device.
- At least 10 cm away from adjacent devices and walls.
- Solid bench with stable, horizontal and even work surface.

### 4.3 Installing the instrument



---

#### **WARNING! Risk from incorrect supply voltage**

- ▶ Only connect the device to voltage sources which correspond to the electrical requirements on the name plate.
- ▶ Only use sockets with a protective earth (PE) conductor and suitable mains/ power cord.

- 
1. Connect the provided mains cable to the mains connection socket of the Eporator and the power supply.
  2. Switch on the Eporator at the mains power switch.

## 5 Operation

### 5.1 Overview of operating controls

Familiarize yourself with the operating control elements and the display of the Eporator before using it for the first time.

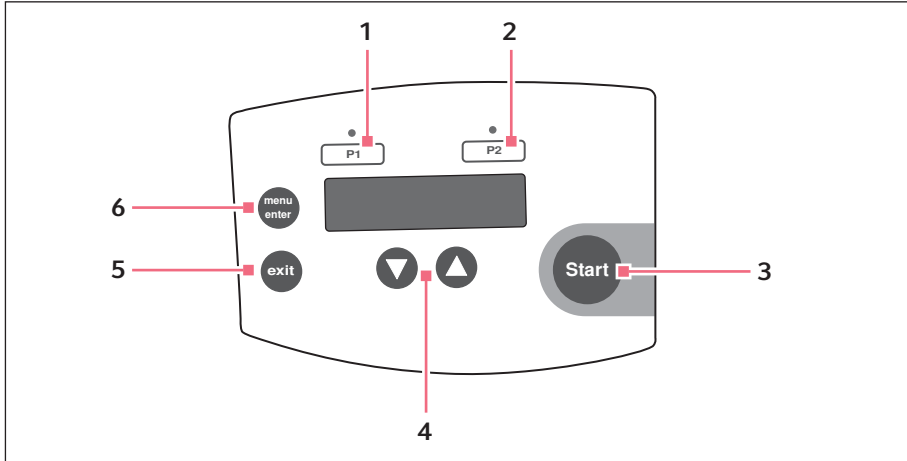

Fig. 5-1: Operating controls

- |   |  |
|---|--|
| <p><b>1 P1 program key with control LED</b><br/>Press: load voltage value. Press and hold (&gt; 2 s): save current voltage value.</p> | <p><b>4 Arrow keys</b><br/>Set the voltage</p>               |
| <p><b>2 P2 program key with control LED</b><br/>Press: load voltage value. Press and hold (&gt; 2 s): save current voltage value.</p> | <p><b>5 Exit key</b><br/>Exit the menu</p>                   |
| <p><b>3 Press the Start key</b><br/>Start electroporation</p>   | <p><b>6 menu/enter key</b><br/>Select the menu parameter</p> |

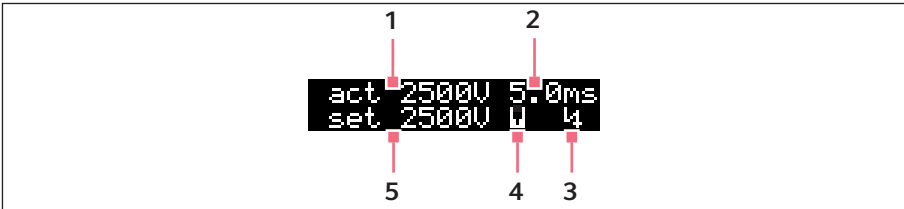

Fig. 5-2: Display

- |   |   |
|---|---|
| <p><b>1 Actual voltage value (in V)</b></p> <p><b>2 Actual discharge time (in ms)</b></p> <p><b>3 Voltage symbol</b><br/>The voltage symbol <b>V</b> appears after electroporation and disappears after the cuvette carrier has been removed.</p> | <p><b>4 Cuvette symbol</b><br/>The cuvette symbol <b>W</b> appears when a cuvette is inserted.</p> <p><b>5 Set voltage (in V)</b></p> |
|---|---|

## 5.2 Recommendations for sample preparation

Independent of the device, the success of an electroporation is influenced by a variety of factors:

- Quality and concentration of the inserted DNA
- Quality and concentration of the cells
- Resuspension medium of the DNA and cells

### 5.2.1 DNA preparation

- **DNA quality:** In order to obtain a high transformation efficiency, the DNA solution should be pure and free of salts.
- **Buffer:** DNA dissolved in TE buffer is acceptable if the DNA was dissolved in approx. ten times the quantity of electrocompetent cells.
- **Salt concentration:** DNA from enzyme reactions (e.g. ligation) can be immediately used for electroporation if the salt concentration is under 5 M. If the ionic strength of the reaction combination is too high, it can be reduced via dilution or ethanol precipitation. After ethanol precipitation, the DNA can be resuspended in sterile, demineralized water or TE buffer.
- **Incubation:** Before electroporation, do not incubate the DNA with the cell suspension too long. Generally, the DNA should be added to the cells one minute before electroporation and the solution should be incubated at 0 °C. Long incubation times can lead to DNA degradation due to the DNases in the cell suspension.

- **DNA concentration:** The concentration of DNA can significantly influence the transformation efficiency.
- **Frequency and efficiency:** The frequency is defined as the number of transformed cells per surviving cells. The efficiency is defined as transformed cells per  $\mu\text{g}$  DNA. You can obtain a high frequency by using high DNA concentrations. High efficiency is achieved by using high cell concentration. Reducing the DNA concentration helps prevent co-transformations of the same cell.

### 5.2.2 Electroporation medium

- **Sensitivity of the cells:** The cells are sensitive to external influences because electroporation creates temporary pores in the cell membrane.
- **Electrolysis of the medium:** During electroporation, the electrolysis of the medium significantly influences the characteristics of the medium (e.g. the pH value). Many cells can die if fresh medium is not immediately added after electroporation for the recovery of the cells (see *Regeneration of the cells on p. 17*).
- **Ionic strength of the medium:** The ionic strength of the medium must be taken into account during electroporation of cells. In order to keep the resistance of the medium as high as possible, salts must be removed from the cell and DNA preparation. Ions remaining in the cell suspension often come from the culture medium. Higher transformation efficiency can be obtained by removing salts from the DNA solution and cell preparations. Generally, the lowest possible ionic solution that cells can withstand is preferred.

### 5.2.3 Growth and preparation of cells

- **Growth phase of cells:** For optimum electroporation efficiency use bacterial (e.g. *E. coli*) or yeast cells in the exponential growth phase.
- **Preparation of cells:** Thoroughly wash the cells in order to remove the growth medium that affects electrocompetence.
- **Concentration of cells:** Use a final concentration of cells of about  $1\text{-}3 \times 10^{11}$  cells/mL. If this value is exceeded, the homogeneity of the electrical field can be affected.
- **Requirements for an electroporation:** Each bacteria strain and yeast strain has optimal conditions that must be determined empirically. These conditions include:
  - The cell volume
  - The quantity of the specific plasmid
  - The used field strength (E). For *E. coli*, a field strength of 12-19 kV/cm is generally required to reach a maximum transformation efficiency. The field strengths are calculated from the voltage used and the distance of the electrodes ( $E = V/\text{cm}$ ).

### 5.2.4 Temperature

- **Cooling electroporation cuvettes:** Electroporation of microorganisms produces the best results at low temperatures (0-4 °C). Cool the electroporation cuvettes to 0 °C before electroporation. Remove residual moisture from the electroporation cuvette before inserting it in the Eporator.

## 5.3 Performing electroporation

### 5.3.1 Switching on the device

- ▶ Press the mains power switch on the rear of the device to switch on the device.

### 5.3.2 Inserting the cuvette



To increase the efficiency of the electroporation, the electroporation cuvette can be cooled prior to filling. Remove residual liquids from the cuvette before further use.

The integrated cuvette holder is located at the front of the device to the right of the control panel.

Proceed as follows:

1. Remove the cuvette holder from the device.  
The cuvette holder is now freely accessible for the insertion of the electroporation cuvette.
2. Remove the electroporation cuvette from the individual packaging.
3. Remove the lid of the electroporation cuvette.
4. Fill the electroporation cuvette with the sample. The slit between the plate electrodes must be filled without bubbles.
5. Place the locking lid on the electroporation cuvette.



---

**NOTICE! Damage to device due to penetration of liquids.**

Liquid can enter the device during electroporation with cuvettes without lids.

- ▶ Only cuvettes with square lids may be used for electroporation.

- 
6. Insert the electroporation cuvette into the cuvette holder with the plastic nose pointing towards the back.(Fig. 5-3 on p. 16)

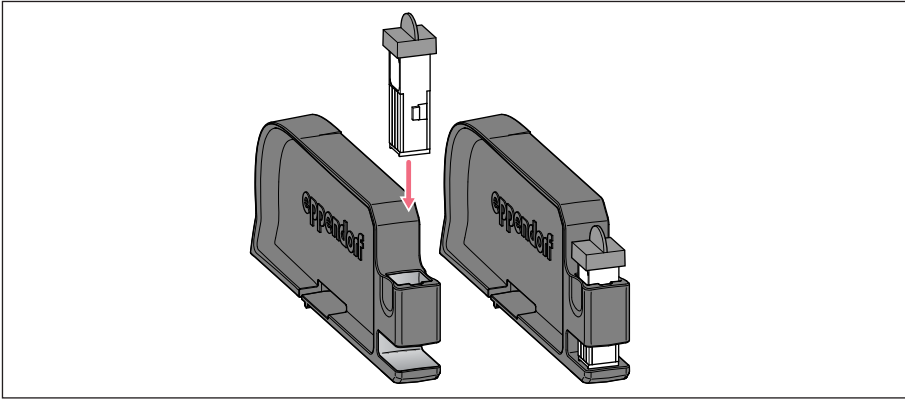

Fig. 5-3: Insert the electroporation cuvette

**i** Operate the cuvette holder with two hands to prevent the cuvette holder from tipping.

7. Slide the holder in the cuvette shaft of the Eporator until it engages (Fig. 5-4 on p. 16).

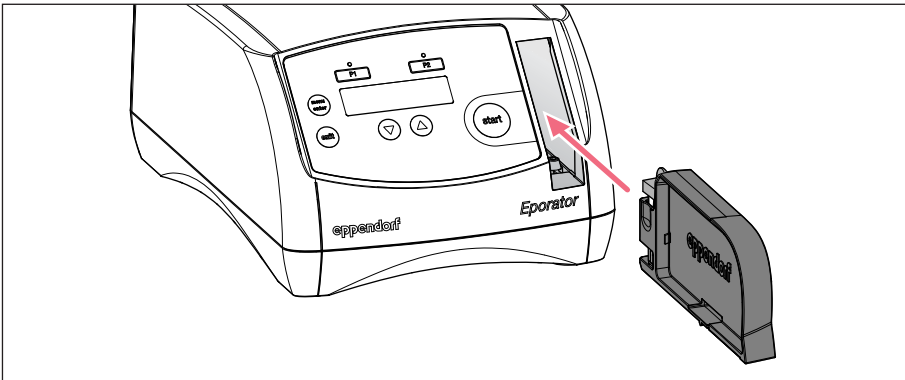

Fig. 5-4: Insert the cuvette holder

In the display, the actual parameters of the last run disappear and a cuvette symbol appears in the lower line.

set 2500V W



### 5.3.3 Electroporation



1. Set a voltage between 200 V and 2500 V using the arrow keys.  
After switching on the device, the last set voltage is always displayed. The most frequently used voltages can be saved and accessed using the program keys (see *Programs on p. 18*).



2. Press the **Start** key to start the electroporation process.
  - *Charge* and a progress bar appear in the display during loading.
  - A signal tone sounds after the discharge.
  - After the electroporation, the actual voltage (act), the discharge time of the performed electroporation, and a voltage symbol appear in the display.

```
act 2500V 5.0ms
set 2500V W 4
```

3. Remove cuvette holder from the device.  
The cuvette symbol and voltage symbol disappear.
4. Remove electroporation cuvette from the cuvette holder and carefully transfer the sample to the corresponding medium without bubbles.

### 5.4 Regeneration of the cells

#### Example for the bacterium *E. coli*:

1. After the electroporation, immediately place about 1 mL fresh medium (without selection chemicals) on the cells. A rich medium is best suited for this, e.g. the SOC medium for *E. coli*.
2. Carefully resuspend cells and transfer them to a new tube.
3. Incubate cells at optimal growth temperature (e.g. 37 °C for *E. coli*) for one hour at light vibration (e.g. with the Eppendorf Thermomixer comfort).

### 5.5 Determination of the transformation efficiency

After the recovery period, the cells should be plated with a selection medium.

To determine the efficiency, streak different cell concentrations and use this information to calculate the number of transformers/ $\mu\text{g}$  DNA.

## 5.6 Programs

A program contains a saved voltage setting for quick access to frequently used settings.

### 5.6.1 Loading program

The programs 1 and 2 are stored with the following parameters at delivery:

- Program key **P1**: 1700 V  
(e.g. for *E. coli* electroporation in 1 mm electroporation cuvettes)
  - Program key **P2**: 2500 V  
(e.g. for *E. coli* electroporation in 2 mm electroporation cuvettes)
- ▶ Press desired program key  
The control LED above the pressed program key illuminates blue, the voltage is displayed.

### 5.6.2 Saving program



1. Use the arrow keys to set the voltage.



2. Hold down the desired program key for at least **2 seconds**.  
A signal tone sounds. *Voltage stored* appears in the display. The control LED over the pressed program key illuminates blue. The voltage is saved under the corresponding program number (1 to 2).

## 5.7 Enhanced settings

Additional settings can be carried out in the menu. The date and time can be defined in the device in order to track exported data. The following settings are available:

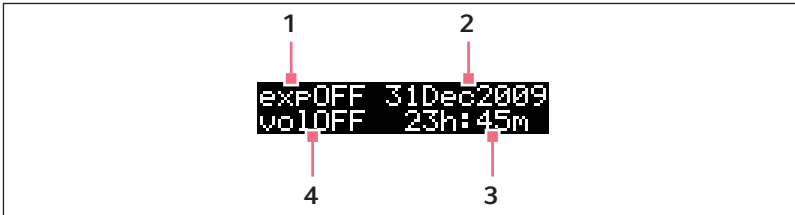

Fig. 5-5: Menu display

### 1 Data export

The data export is described in the chapter "Export data" (see p. 19).

### 2 Date

Set date.

### 3 Time

Set time.

### 4 Signal tone

Set signal tone. The display switches between *vol1* (very quiet), *vol2* (quiet), *vol3* (loud), *vol4* (very loud) and *vol OFF* (signal tone switched off).

## Open menu.



1. Press **menu/enter** key.

## Switch between parameters



2. Press **menu/enter** key.  
The selected parameter blinks in the display.

## Change the value of the parameter



3. Press the arrow keys.

## Exit the menu.



4. Press the **exit** key.  
The changed parameters are automatically saved.

## 5.8 Exporting data

Using the USB port at the rear of the device, you can save the last 50 experiments on a USB stick in separate TXT files (see *Product overview on p. 9*). The files are named according to the corresponding sample number. This format is well-suited for additional editing in a text editor or Microsoft Excel.

The data sets of an electroporation contain the following information:

- **Sample number (sample)** of the experiment  
For each experiment, the device automatically assigns a four-digit sample number that is counted from 0001 upwards.
- **Date (date)** of the experiment
- **Time (time)** of the experiment
- **Set voltage (set)** of the experiment  
Voltage that was selected for the corresponding experiment using the arrow keys.
- **Actual voltage (act)** of the experiment  
Voltage that was actually applied to the electroporation cuvette in the corresponding experiment.
- **Time constant of the discharge curve (tc)** of the experiment  
Time constant of the discharge curve of the corresponding experiment.
- **Software version (sw)** of the device
- **Serial number (serial no)** of the device



Date and time can be specified in the enhanced settings (see p. 18).

### Insert USB stick

1. Insert a standard USB stick in the USB port at the rear of the device.  
(see *Product overview on p. 9*)

### Open menu.



2. Press **menu/enter** key.  
The menu is displayed and a cursor blinks in the export display *exp OFF*.

### Activate parameter



3. Press one of the arrow keys.  
The selection item *exp ON* is displayed.

### Export data



4. Press the **Start** key.  
The data transfer is started. The main screen is displayed after the export is completed.

## 6 Troubleshooting

### 6.1 General errors

Many factors can contribute to a low transformation efficiency:

- **The set voltage:** Specific voltage parameters exist for each microorganism. Some cells die during electroporation. If the field strength is too high or too low, a low transformation efficiency is achieved. The expected survival rate varies between 20 % and 80 % of inserted cells. The electroporation of *E. coli* requires an impulse of approximately 5 ms and field strengths between 12 kV/cm and 19 kV/cm. You should check the transformation efficiency at different voltages in order to optimize conditions.

Application protocols for the electroporation of various bacteria and yeast strains can be found on the Eppendorf home page [www.eppendorf.com](http://www.eppendorf.com).

- **The cells:** Generally, cells are transformed most efficiently when they are in an early to medium log phase. Different growth conditions can improve the transformation efficiency (see *Growth and preparation of cells on p. 14*).

If too many cells are killed, the electroporation conditions for the strain must be optimized and the DNA preparation and cell preparation for toxic or organic substances must be inspected (see *DNA preparation on p. 13*).

After electroporation, cells (especially *E. coli*) must be immediately transferred to a rich medium in order to obtain good results. Even a small delay in completing this step can lead to a significantly lower transformation efficiency (see *Regeneration of the cells on p. 17*).

- **The DNA:** The quantity and quality of the DNA used should be checked before electroporation. Incorrectly concentrated or degraded DNA leads to low transformation efficiency.

Salts and other components that can have a toxic effect on cells must be removed from the DNA preparation before the preparation process.

The DNA preparation should be added to the cells no longer than one minute before the electroporation. DNase present in cell preparation can degrade the DNA and thereby cause a low transformation efficiency (see *DNA preparation on p. 13*).

- **The temperature:** Electroporation cuvettes should be cooled to 0 °C - 4 °C before electroporation (see *Temperature on p. 14*). This produces better results than with electroporation cuvettes at room temperature.

If frozen cells are used, electroporation should be performed immediately after thawing. Frozen cells can be stored a maximum of 6 - 12 months in 10 % - 15 % glycerine at -80 °C.

- **Deviating voltages during transformation:** The voltage applied to the electroporation cuvette (*act*) greatly differs from the set voltage (*set*)

A too low resistance has several causes:

- The cells were washed and resuspended in a buffer with a too high ionic strength.

- The cells were not sufficiently cleaned during the preparation. After insufficient washing, growth medium residue, which has been carried along, leaves behind unwanted salts.
- Lysed cells are in the preparation. They contribute to the reduction of the resistance of the medium.
- The salt concentration in the DNA preparation is too high.

## 6.2 Error messages



If the proposed measures repeatedly fail to remedy the fault, contact your local Eppendorf partner. The addresses of our distributors can be found on our website [www.eppendorf.com](http://www.eppendorf.com). The addresses of our sales offices can be found on the second to last page of this operating manual.

- ▶ Quit all error messages with the **Exit** key.

### 6.2.1 Operational error

Problem	Cause	Solution
Display remains dark	<ul style="list-style-type: none"> <li>• The device was not connected to the mains supply or the mains power switch was not switched on.</li> </ul>	<ul style="list-style-type: none"> <li>▶ Check the mains connection and the power cable.</li> <li>▶ Switch on the device.</li> </ul>
The display shows: <i>function not available</i>	<ul style="list-style-type: none"> <li>• A key that is not available in the current device state was pressed (e.g. the <b>Exit</b> key in the main display).</li> </ul>	<ul style="list-style-type: none"> <li>▶ Message disappears after about 2 seconds.</li> </ul>
The display shows: <i>no cuvette</i>	<ul style="list-style-type: none"> <li>• The <b>Start</b> key was pressed before an electroporation cuvette was inserted.</li> </ul>	<ol style="list-style-type: none"> <li>1. Insert an electroporation cuvette.</li> <li>2. Start electroporation (see <i>Inserting the cuvette on p. 15</i>).</li> </ol>
The display shows: <i>no USB stick</i>	<ul style="list-style-type: none"> <li>• The export command was activated before a USB stick was inserted in the USB port of the device.</li> </ul>	<ol style="list-style-type: none"> <li>1. Insert a USB stick in the USB port of the device.</li> <li>2. Repeat the export command (see <i>Exporting data on p. 19</i>).</li> </ol>
The display shows: <i>USB stick full</i>	<ul style="list-style-type: none"> <li>• A USB stick with no storage capacity was inserted in the USB port of the device.</li> </ul>	<ol style="list-style-type: none"> <li>1. Insert a USB stick with sufficient storage capacity in the USB port of the device.</li> <li>2. Repeat the export command (see <i>Exporting data on p. 19</i>).</li> </ol>

Problem	Cause	Solution
The display shows: <i>no export</i>	<ul style="list-style-type: none"> <li>The export of the data from the device has failed.</li> <li>All existing electroporation protocols have already been saved on the USB stick.</li> </ul>	<ol style="list-style-type: none"> <li>Insert a standard USB stick in the USB port of the device.</li> <li>Repeat the export command (see <i>Exporting data on p. 19</i>).</li> </ol>
The display shows: <i>no protocol</i>	<ul style="list-style-type: none"> <li>The export of data has failed. No exportable protocols are located in the device.</li> </ul>	<ol style="list-style-type: none"> <li>Perform electroporation</li> <li>Repeat the export command (see <i>Exporting data on p. 19</i>).</li> </ol>

### 6.2.2 Device error

Problem	Cause	Solution
The display shows: <i>Hardware error</i>	<ul style="list-style-type: none"> <li>Device error</li> </ul>	<ol style="list-style-type: none"> <li>Quit the error message with the <b>Exit</b> key.</li> <li>Perform the electroporation again. <ul style="list-style-type: none"> <li>▶ If the error message appears again: switch the device off and on.</li> </ul> </li> </ol>
The display shows: <i>internal error</i>	<ul style="list-style-type: none"> <li>Device error</li> </ul>	<ol style="list-style-type: none"> <li>Quit the error message with the <b>Exit</b> key.</li> <li>Perform the electroporation again. <ul style="list-style-type: none"> <li>▶ If the error message appears again: switch the device off and on.</li> </ul> </li> </ol>

## 7 Maintenance

### 7.1 Cleaning



#### **DANGER! Electric shock as a result of penetration of liquid.**

- ▶ Switch off the device and disconnect the mains/power plug before starting cleaning or disinfection work.
- ▶ Do not allow any liquids to penetrate the inside of the housing.
- ▶ Do not spray clean/spray disinfect the housing.
- ▶ Only plug the device back in if it is completely dry, both inside and outside.



#### **NOTICE! Damage from the use of aggressive chemicals.**

- ▶ Do not use any aggressive chemicals on the device or its accessories, such as strong and weak bases, strong acids, acetone, formaldehyde, halogenated hydrocarbons or phenol.
- ▶ If the device becomes contaminated with aggressive chemicals, clean it immediately using a mild cleaning agent.

- ▶ Wet a cloth with a mild cleaning fluid and demineralized water and remove the contamination on the outside of the device.

### 7.2 Replacing fuses

The fuse holder is located between the mains/power cord socket and the mains/power switch.

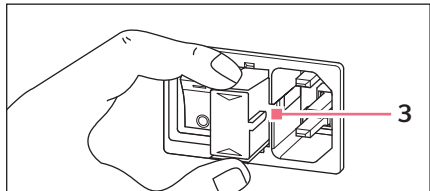
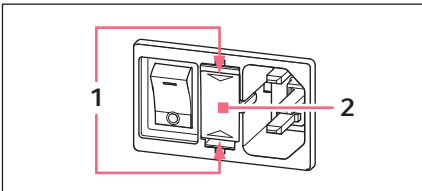

1. Unplug the mains/power plug.
2. Press the upper and lower end of the plastic springs **1** together and pull the fuse holder **2** fully out.
3. Replace faulty fuses and reinsert the fuse holder. Make sure that the guiding rail **3** is positioned correctly.



## **8 Technical data**

### **8.1 Power supply**

Mains power connection	100 V to 240 V $\pm 10$ %, 50 Hz to 60 Hz Automatic adjustment to the voltage
Power consumption	20 W
Charging time	< 10 s

### **8.2 Ambient conditions**

Environment	For indoor use only
Ambient temperature	5 °C to 40 °C
Relative humidity	10 % to 90 %
Atmospheric pressure	79.5 kPa to 106 kPa (2000 m)
Degree of pollution	2

### **8.3 Weight/dimensions**

Weight	3.2 kg
Dimensions	Width: 19 cm (7.48 in) Height: 12.5 cm (4.92 in) Depth: 27.5 cm (10.83 in)

### **8.4 Interfaces**

USB	USB 2.0
RS232	Only for Technical Service

### **8.5 Operating mode**

Power-on time	10 %, 120 s max
---------------	-----------------

## 9 Transport, storage and disposal

### 9.1 Storage

	Air temperature	Rel. humidity	Air pressure
In transport packaging	-25 to 55°C	10 to 95%	70 to 106 kPa
Without transport packaging	-5 to 45°C	10 to 95%	70 to 106 kPa

### 9.2 Decontamination before shipment

If you are shipping the device to the authorized Technical Service for repairs or to your authorized dealer for disposal please note the following:



#### **WARNING! Risk to health from contaminated device**

1. Follow the instructions in the decontamination certificate. You can find it as a PDF file on our website ([www.eppendorf.com/decontamination](http://www.eppendorf.com/decontamination)).
2. Decontaminate all the parts you would like to dispatch.
3. Include the fully completed decontamination certificate in the packing.

### 9.3 Transport

- ▶ Only transport the device in the original packaging.

	Air temperature	Rel. humidity	Air pressure
General transportation	-25 °C to 60 °C	10 % to 95 %	30 kPa to 106 kPa
Air freight	-40 °C to 55 °C	10 % to 95 %	30 kPa to 106 kPa

## 9.4 Disposal

In case the product is to be disposed of, the relevant legal regulations are to be observed.

### Information on the disposal of electrical and electronic devices in the European Community:

Within the European Community, the disposal of electrical devices is regulated by national regulations based on EU Directive 2012/19/EU pertaining to waste electrical and electronic equipment (WEEE).

According to these regulations, any devices supplied after August 13, 2005, in the business-to-business sphere, to which this product is assigned, may no longer be disposed of in municipal or domestic waste. To document this, they have been marked with the following identification:



Because disposal regulations may differ from one country to another within the EU, please contact your supplier if necessary.

## 10 Ordering information

### 10.1 Eporator

Order no. (International)	Order no. (North America)	Description
4309 000.019	–	<b>Eppendorf Eporator</b>

### 10.2 Accessories

Order no. (International)	Order no. (North America)	Description
4308 078.006	940001102	<b>Cuvette stand</b> for 16 cuvettes
4309 900.010	4309900010	<b>Operating Manual Eppendorf Eporator</b>



# Declaration of Conformity

The product named below fulfills the requirements of directives and standards listed. In the case of unauthorized modifications to the product or an unintended use this declaration becomes invalid.

**Product name:**

Eppendorf Eporator®

**Product type:**

electroporator

**Relevant directives / standards:**

2014/35/EU: EN 61010- 1,  
UL 61010- 1, CAN/CSA C22.2 No. 61010- 1

2014/30/EU: EN 55011, EN 61326- 1

2011/65/EU: EN 50581

Date: April 05, 2016



Management Board



Portfolio Management

Your local distributor: [www.eppendorf.com/contact](http://www.eppendorf.com/contact)  
Eppendorf AG · 22331 Hamburg · Germany  
[eppendorf@eppendorf.com](mailto:eppendorf@eppendorf.com)

Eppendorf® and the Eppendorf logo are registered trademarks of Eppendorf AG, Germany.  
U.S. Design Patents are listed on [www.eppendorf.com/ip](http://www.eppendorf.com/ip).  
All rights reserved, incl. graphics and pictures. Copyright 2015 © by Eppendorf AG.

[www.eppendorf.com](http://www.eppendorf.com)

ISO 9001  
Certified

ISO  
13485  
Certified

ISO  
14001  
Certified







# Evaluate Your Manual

Give us your feedback.  
[www.eppendorf.com/manualfeedback](http://www.eppendorf.com/manualfeedback)

**Your local distributor: [www.eppendorf.com/contact](http://www.eppendorf.com/contact)**  
Eppendorf AG · 22331 Hamburg · Germany  
[eppendorf@eppendorf.com](mailto:eppendorf@eppendorf.com) · [www.eppendorf.com](http://www.eppendorf.com)