

**Thermo Scientific
Accel Series
Cooling/Heating
Recirculating Chillers**

Thermo Scientific Manual P/N U01076
Rev. 08/01/2016



**Multilingual Quick
Start Guides**

**Multilingual Essential
Safety Instructions**

Installation

Operation

**Preventive
Maintenance**

Troubleshooting

Visit our Web site at:

<http://www.thermoscientific.com/tc>
Product Service Information, Applications
Notes, SDS Forms, e-mail.

Voice Info: (800) 258-0830

**Thermo Scientific
Accel Series
Cooling/Heating
Recirculating Chillers**

Thermo Scientific Manual P/N U01076
Rev. 08/01/2016



**Multilingual Quick
Start Guides**

**Multilingual Essential
Safety Instructions**

Installation

Operation

**Preventive
Maintenance**

Troubleshooting

Visit our Web site at:

<http://www.thermoscientific.com/tc>
Product Service Information, Applications
Notes, SDS Forms, e-mail.

Voice Info: (800) 258-0830

Thermo Fisher Scientific

25 Nimble Hill Road
Newington, NH 03801
Tel : (800) 258-0830 or
(603) 436-9444
Fax : (603) 436-8411
www.thermoscientific.com/tc

Sales, Service, and Customer Support

25 Nimble Hill Road
Newington, NH 03801
Tel: (800) 258-0830
Sales: 8:00 am to 5:00 pm
Service and Support: 8:00 am to 6:00 pm Monday
through Friday (Eastern Time)
Fax: (603) 436-8411
service.tc.us@thermofisher.com

Dieselstrasse 4
D-76227 Karlsruhe, Germany
Tel : +49 (0) 721 4094 444
Fax : +49 (0) 721 4094 300
info.tc.de@thermofisher.com

Building 6, No. 27
Xin Jinqiao Rd., Shanghai 201206
Tel : +86(21) 68654588
Fax : +86(21) 64457830
info.china@thermofisher.com

Statement of Copyright

Copyright © 2016 Thermo Fisher Scientific. All rights reserved.

This manual is copyrighted by Thermo Fisher Scientific.

Users are forbidden to reproduce, republish, redistribute, or resell any materials from this manual in either machine-readable form or any other form.

Table of Contents

Quick Start

Preface	i
Compliance	i
WEEE	i
After-Sale Support	i
Feedback	ii
Warranty	ii
Unpacking	ii
Section 1 Safety	1-1
Safety Warnings	1-1
Section 2 General Information	2-1
Description and Intended Use	2-1
Specifications	2-1
Equipment Ratings	2-4
Approved Fluids	2-4
Wetted Materials	2-4
Section 3 Installation	3-1
Ventilation	3-1
Electrical Requirements	3-1
Plumbing Requirements	3-2
Fluid Considerations	3-3
Approved Fluids	3-4
Filling Requirements	3-6
Draining	3-7
Shipping/Storage	3-7
Section 4 Operation	4-1
Controller	4-1
Setup	4-2
Start Up	4-2
Status Display	4-3
Stand By Mode	4-3
Stopping the Chiller	4-3
Power Down	4-3
Shut Down	4-3

	Restarting	4-3
	Changing the Setpoint.....	4-4
	Menu Displays.....	4-5
	Menu.....	4-5
	Menu Tree.....	4-6
	Settings	4-7
	System.....	4-12
	High Temperature Cutout.....	4-16
Section 5	Preventive Maintenance.....	5-1
	Cleaning	5-1
	Condenser.....	5-1
	Fluid Maintenance	5-1
	Sight Tube.....	5-1
	Testing the Safety Features.....	5-1
	Decommissioning/Disposal.....	5-2
Section 6	Troubleshooting.....	6-1
	Error Displays.....	6-1
	Check List.....	6-3
Appendix	AC Serial Communications Protocol.....	A-1
	Declaration of Conformity	
	Warranty	

Safety Precautions:

- The chiller is designed for indoor use only.
- Never place the chiller in a location where excessive heat, moisture, inadequate ventilation, or corrosive materials are present.
- Never use flammable or corrosive fluids.
- Never connect process fluid lines to your facility water supply or to any pressurized liquid source.
- Before using any fluid or performing maintenance where contact with the fluid is likely refer to the manufacturer's MSDS for handling precautions.

What you need to get started:

- An adjustable wrench
- Appropriate hose or plumbing
- Appropriate size clamps or connection type

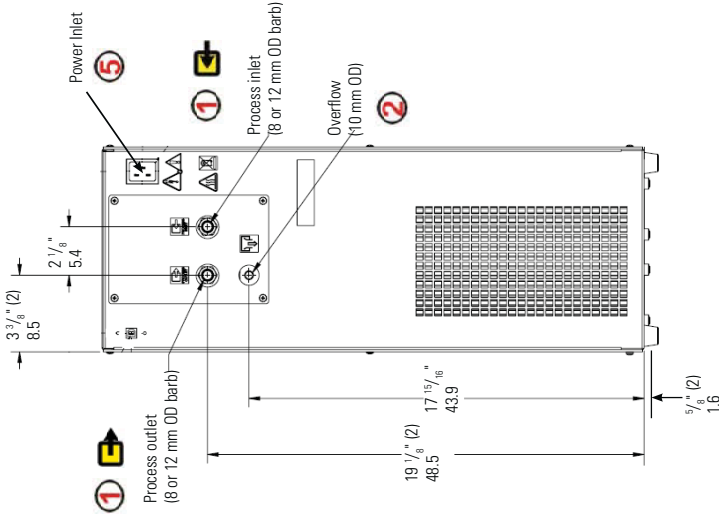

1 Ensure that all shipping plugs are removed before installation.

The process fluid connections are located on the rear of the chiller and are labeled (PROCESS OUTLET) and (PROCESS INLET).

Connect the PROCESS OUTLET to the fluid inlet on your application. Connect the PROCESS INLET to the fluid outlet on your application. Ensure all connections are secure.

Keep the distance between the chiller and the instrument being cooled as short as possible. To minimize back pressure, ensure tubing is as straight as possible. If diameter reductions are required, make them at the inlet and outlet of your application, not at the chiller.

2 Ensure that the cap is removed from the reservoir overflow located at the rear of the chiller and that the overflow is connected to a suitable drain or vessel.

To prevent damage to the chiller's plumbing, use a 19 mm backing wrench when removing/installing the external connections. ▲



Table 1 - Fluids:

Use of any fluid not listed below voids the manufacturer's warranty.
5°C to 80°C — Distilled Water or Deionized Water (up to 3 MΩ-cm)
-10°C to 80°C — 50/50 Water with Glycol

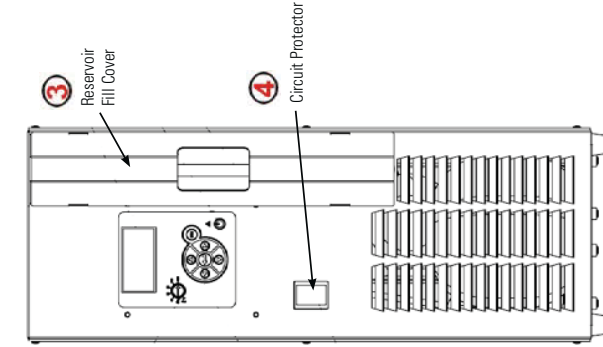

3 Lift up on the fill panel on the front of the chiller to remove it. Start with 2.8 liters of fluid.

Insert the supplied funnel into the hose and slowly add fluid. Note Due to the chiller's plumbing configuration, adding fluid too quickly may result in overflowing - the fill level indication lags the actual amount added.

When pouring fluid into the funnel ensure the fluid contacts the side of the funnel first, A. Pouring the fluid into the center of the funnel, B, causes air pockets and substantially slow down the filling time.

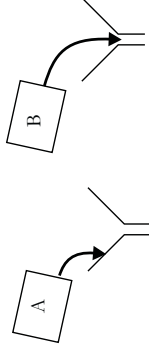

Using the fill lines, verify the desired fluid level.



Since the reservoir capacity may be small compared to your application and air may need to be purged from the lines, have extra cooling fluid on hand to keep the system topped off when external circulation is started.

Avoid overflowing, fluids expand when heated.

4 Ensure the circuit protector to the off (O) position.

5 Verify the appropriate voltage. For chillers supplied with a line cord, insert female end of power cord into chiller and then insert male end of power cord into power outlet. (The line cord is located under the shipping crate's lid. Do not discard the lid until the cord is located.)



Start Up

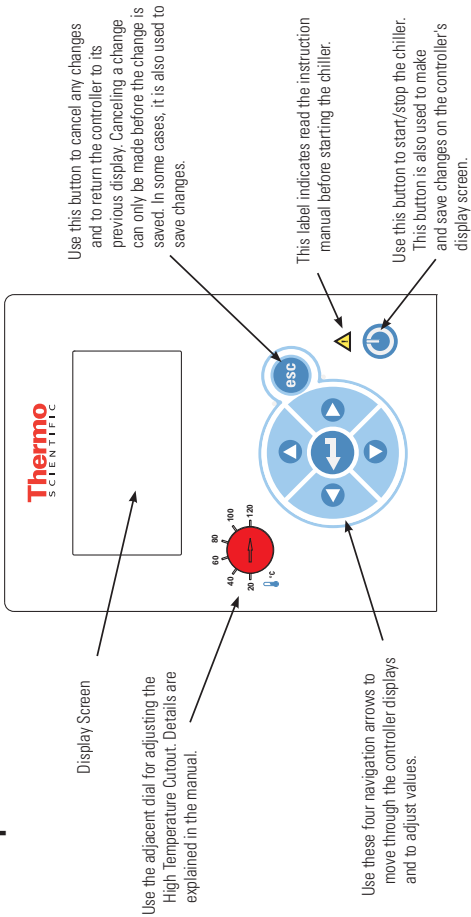



Leave chillers in an upright position at room temperature (~25°C) for 24 hours before starting. This ensures the lubrication oil has drained back into the compressor.

Before starting the chiller, double check all USB (optional), electrical and plumbing connections.

Using a flathead screwdriver, ensure the High Temperature Cutout is in the full clockwise position.

Do not run the chiller until fluid is added. Have extra fluid on hand. If the chiller will not start refer to the manual.

- Place the circuit protector located on the front of the chiller to the **I** position.
- Press , the Start Display appears.
- Ensure the start symbol has a highlight box around it, if not use the arrow keys to navigate to the symbol.
- Press . The chiller starts and the start symbol turns into a stop symbol ().

Note It takes 30 seconds for the compressor to start.

After start, check all external plumbing connections for leaks.

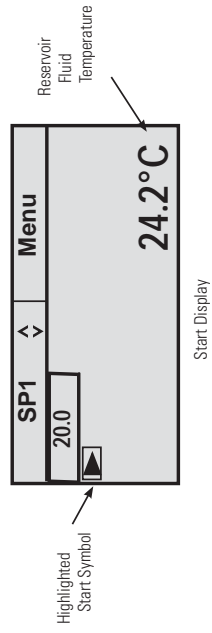

The **SP1** and **Menu** portions on the top of the display are used to view and/or change the controller's settings. They are explained in detail in the manual.

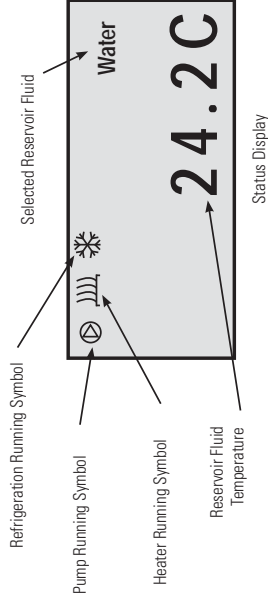

If desired, press  to bring up the Status Displays.



If desired, press  to toggle between the Start/Status Displays.

Shut Down

Ensure the stop symbol has a box around it, if not use the arrow keys to navigate to the symbol.

Press . The chiller stops and the stop symbol turns into a start symbol ().

Press . The controller's screen goes blank.

Place the circuit protector on the front of the chiller to the **O** position.

Precauciones de seguridad:

- La unidad está diseñada sólo para uso interior.
- No coloque nunca la unidad donde quede expuesta a exceso de calor, humedad, mala ventilación o materiales corrosivos.
- No utilice nunca fluidos inflamables o corrosivos con esta unidad.
- Nunca conecte líneas de fluidos de proceso al suministro de agua de la instalación ni a ninguna fuente líquida presurizada.
- Antes de utilizar cualquier fluido o realizar operaciones de mantenimiento que entrañen riesgo de contacto con el fluido, consulte las precauciones de manipulación en el documento MSDS del fabricante.

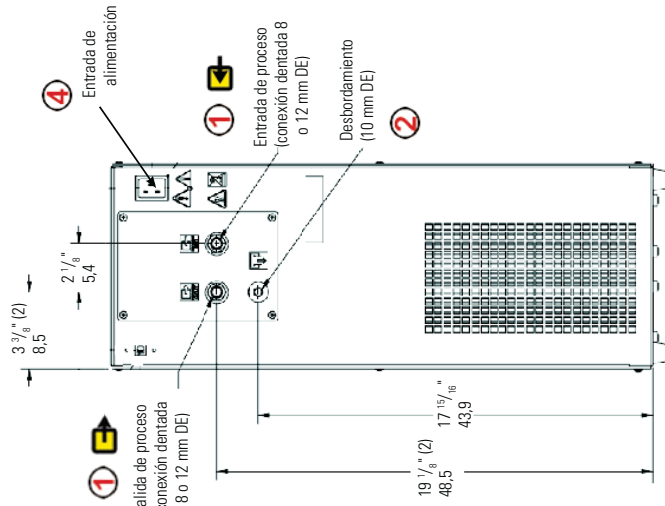

Para evitar que se produzcan daños en la fontanería del circulador, utilice una llave inglesa fija de 19 mm para retirar o instalar las conexiones externas.

Qué se necesita para empezar:

- Una llave inglesa ajustable
- Manguera o tubería adecuada
- Abrazaderas o tipo de conexión adecuada

1 No olvide quitar todos los tapones de transporte antes de realizar la instalación.

Las conexiones de fluido de proceso se encuentran en la parte posterior de la unidad y llevan las etiquetas (SALIDA DE PROCESO) y (ENTRADA DE PROCESO).

Conecte la SALIDA DE PROCESO a la entrada de fluido de su aplicación. Conecte la ENTRADA DE PROCESO a la salida de fluido de su aplicación. Cerciórese de que todas las conexiones están firmes.

Mantenga la mínima distancia posible entre la unidad y el instrumento que refrigera. Para minimizar la contrapresión, procure que los tubos queden tan rectos como sea posible. Si hace falta reducir diámetros, hágalo en la entrada y la salida de su aplicación, no en el enfriador.

2 Asegúrese de que el tapón se quita del desbordamiento del depósito situado en la parte trasera del refrigerador y que el desbordamiento se conecta a un drenaje adecuado o buque.

Tabla 1 - Fluidos aceptables:

El uso de cualquier fluido no indicado a continuación anulará la garantía del fabricante.
 5°C a 80°C: agua destilada o desionizada (hasta 3 MQ-cm)
 -10°C a 80°C: agua con glicol 50/50

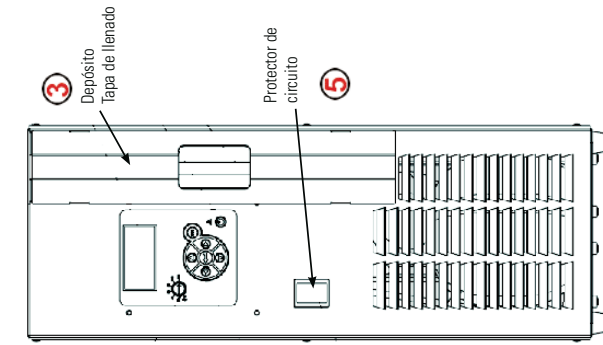

3 Levante el panel frontal de llenado de la unidad para quitarlo. Empiece con 2,8 litros de fluido.

Inserte el embudo suministrado en la manguera y vierta el fluido lentamente. NOTA: si introduce el fluido demasiado rápido, la unidad se puede llenar en exceso, porque el indicador del nivel de llenado tarda en reflejar la cantidad añadida debido a la configuración de sus conductos.

Al echar el fluido en el embudo, cerciórese de que toca primero en el como (A). Si el fluido cae directamente en el vástago del embudo (B), se crearán bolsas de aire que ralentizan considerablemente el llenado.



Verifique el nivel de fluido mediante las líneas de llenado.



Como la capacidad del depósito puede ser pequeña para su aplicación y quizá haya que purgar aire de las conducciones, debe tener a mano más fluido refrigerante para mantener lleno el sistema cuando comience la circulación externa.

Evite el llenado excesivo, porque los fluidos se expanden al calentarse.

4 Verifique el voltaje apropiado. En las unidades que incluyen cable de alimentación, conecte el extremo hembra de dicho cable al enfriador y después el extremo macho a la toma de alimentación. (El cable de alimentación se encuentra bajo la tapa del cajón de embalaje. No tire la tapa sin haber localizado el cable.)

5 Coloque el protector de circuito en la posición de encendido (I).

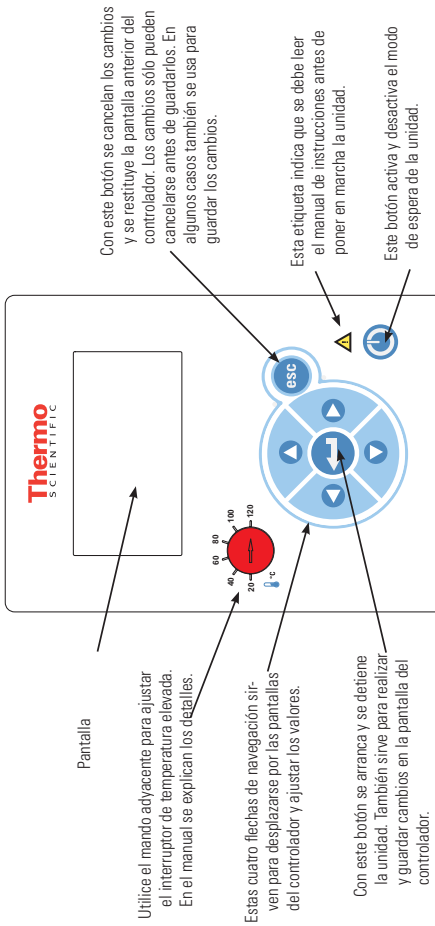

Puesta en marcha



Las unidades deben mantenerse en posición vertical a temperatura ambiente (~25°C) durante 24 horas antes de ponerlas en marcha. Así se asegura que el aceite lubricante ha vuelto al compresor.

Antes de poner en marcha la unidad, verifique todas las conexiones USB (opcional), eléctricas y de conductores.

No ponga en marcha la unidad sin haberle añadido el fluido. Tenga a mano fluido adicional. Si la unidad no arranca, consulte el manual.

- Coloque en la posición **I** el protector de circuito que hay en la parte frontal de la unidad.
- Pulse  y aparecerá la pantalla de inicio.
- Compruebe si el símbolo de inicio está rodeado por un cuadro resaltado; de lo contrario, utilice los botones de flecha para ir a dicho símbolo.
- Pulse . La unidad arrancará y el símbolo de inicio cambiará al de parada ().

NOTA: El compresor tarda 30 segundos en arrancar.

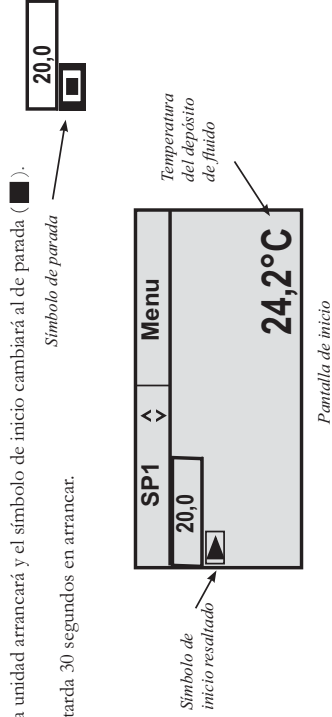

Después de arrancar, busque posibles fugas en todas las conexiones de conductos externas.

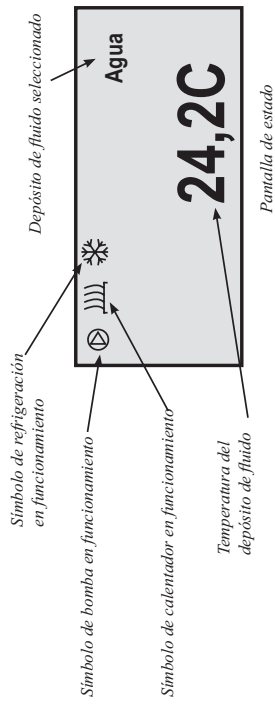

Las áreas **SP1** y **Menu** de la parte superior de la pantalla sirven para ver y/o cambiar los ajustes del controlador. Se explican en detalle en el manual.

Para ver las pantallas de estado, pulse .



Para cambiar entre las pantallas de inicio/estado, pulse .

Apagado

- Compruebe si el símbolo de parada está rodeado por un cuadro; de lo contrario, utilice los botones de flecha para ir a dicho símbolo.
- Pulse . La unidad se detiene y el símbolo de parada cambia al de inicio ().
- Pulse . La pantalla del termostato queda en blanco.
- Coloque en la posición **O** el protector de circuito que hay en la parte frontal de la unidad.

Sicherheitsvorkehrungen:

Das Gerät darf nur in geschlossenen Räumen betrieben werden. Stellen Sie das Gerät niemals an Orten auf, wo es übermäßiger Hitze, Feuchtigkeit, unzureichender Belüftung oder korrosiven Stoffen ausgesetzt ist. Verwenden Sie niemals brennbare oder korrosive Flüssigkeiten in diesem Gerät.

Schließen Sie niemals Prozessflüssigkeitsleitungen an die Kühlwasserversorgung oder an einen Anschluss für unter Druck stehende Flüssigkeiten an.

Bevor Sie Flüssigkeiten einsetzen oder eine Wartung durchführen, bei denen Sie möglicherweise mit Flüssigkeiten in Berührung kommen, beachten Sie die im Sicherheitsdatenblatt des Herstellers beschriebenen Vorsichtsmaßnahmen.

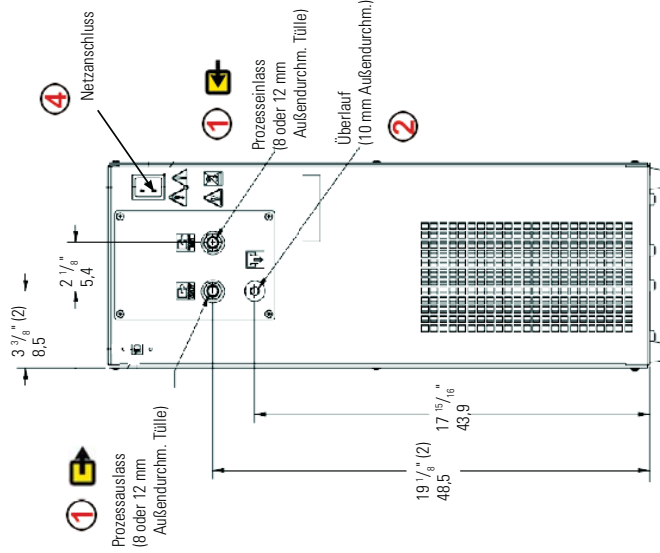

Sie benötigen:

- einen verstellbaren Schraubenschlüssel
- passende Schläuche bzw. Leitungen
- passende Klemmen oder Anschlussstücke

1 Vor der Installation müssen alle Transportstoppfen entfernt worden sein.

Die Anschlüsse für die Prozessflüssigkeit befinden sich auf der Geräterückseite und sind mit den Symbolen (PROZESSFLÜSSIGKEITSAUSLASS) und (PROZESSFLÜSSIGKEITSEINLASS) gekennzeichnet.

Verbinden Sie den PROZESSFLÜSSIGKEITSAUSLASS mit dem Flüssigkeitsinlass Ihrer Applikation. Verbinden Sie den PROZESSFLÜSSIGKEITSEINLASS mit dem Flüssigkeitsauslass Ihrer Applikation. Alle Verbindungen müssen fest und sicher sitzen.

Halten Sie den Abstand zwischen dem Gerät und dem zu kühlenden Instrument so klein wie möglich. Zur Minimierung des Rückstaudruckes müssen die Schläuche möglichst gerade verlaufen. Wenn kleinere Durchmesser erforderlich sind, sollten diese am Ein- und Auslass Ihrer Applikation und nicht am Kühlaggregat angeschlossen werden.

2 Sicherzustellen, dass die Kappe wird aus dem Vorratsbehälter überlaufen, die sich an der Rückseite der Kältemaschine und der Überlauf ist an einen geeigneten Behälter entleeren oder.

Tabelle 1 - Zulässige Flüssigkeiten: Die Verwendung anderer Flüssigkeiten als der nachstehend aufgeführten führt zum Verlust der Herstellergarantie. 5°C bis 80°C — destilliertes oder deionisiertes Wasser (bis zu 3 MΩ·cm) -10°C bis 60°C — Wasser mit Glykol im Mischungsverhältnis 50:50
--

3 Behälterabdeckung an der Gerätevorderseite hochheben, um sie zu entfernen.

Füllen Sie zunächst 2,8 l Flüssigkeit ein.

Stecken Sie den mitgelieferten Trichter in den Schlauch und befüllen Sie den Behälter *langsam*. **HINWEIS** Wegen der Konstruktion des Gerätebehälters kann ein zu schnelles Befüllen zu Überfüllungen führen - die Füllstandsanzeige besitzt eine gewisse Verzögerung, sodass die tatsächlich entgegüllte Menge etwas über der Füllstandsanzeige liegt.

Achten Sie beim Befüllen des Behälters darauf, dass die Flüssigkeit an der Trichterseite in den Behälter läuft, A. Durch Gießen der Flüssigkeit direkt in die Trichtermitte (B) bilden sich Luftblasen, die die Füllzeit erheblich verlängern.

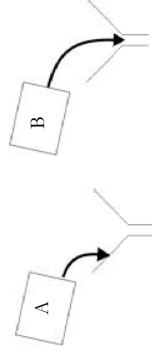

Überprüfen Sie den gewünschten Flüssigkeitsstand an den Füllmarkierungen.



Da möglicherweise die Kapazität des Behälters im Vergleich zu Ihrer Applikation eher gering ist und Luft aus den Leitungen gespült werden muss, sollten Sie weitere Kühlfüssigkeit zum Nachfüllen bereithalten, wenn der externe Kreislauf gestartet wird.

Vermeiden Sie Überfüllungen - Flüssigkeiten dehnen sich bei Erwärmung aus.

4 Kontrollieren Sie, dass die korrekte Spannung eingestellt ist. Stecken Sie bei Geräten mit Stromkabel zunächst das geräteseitige Ende in das Kühlgerät und anschließend den Stecker in eine Steckdose. (Das Stromkabel befindet sich unter dem Deckel der Transportkiste. Werfen Sie den Transportverpackung erst weg, wenn Sie das Stromkabel herausgeholt haben.)

5 Schalten Sie den Netzschalter in die Stellung (I).

Um Beschädigungen der Thermostatanschlüsse zu vermeiden, verwenden Sie beim Entfernen/ Installieren der externen Anschlüsse einen 19 mm-Gabelschlüssel.

Einschalten

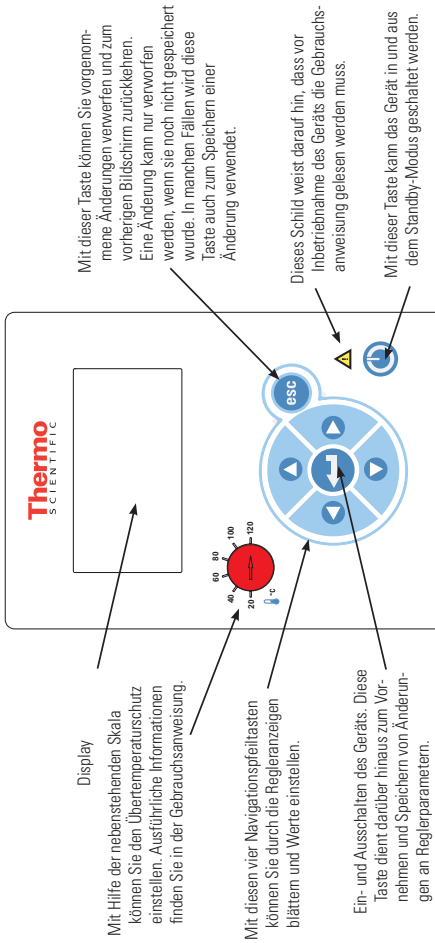



Vor dem Einschalten muss das Gerät mindestens 24 Stunden lang bei ~25°C in aufrechter Position gestanden haben. Dadurch wird gewährleistet, dass das Schmieröl zurück in den Kompressor fließt.

Inspezieren Sie vor dem Einschalten alle elektrischen Anschlüsse, Schlauchverbindungen und (optional) USB-Kabelanschlüsse.

Das Gerät niemals mit leerem Behälter betreiben. Halten Sie zusätzliche Flüssigkeit griffbereit. Konsultieren Sie die Gebrauchsanweisung, wenn sich das Gerät nicht einschaltet.



- Schalten Sie den Netzschalter auf der Gerätevorderseite in die Stellung **I**.
- Drücken Sie auf . Die Startanzeige erscheint.
- Das Startsymbol muss hervorgehoben sein. Gehen Sie mit den Pfeiltasten zu diesem Symbol, wenn dies nicht der Fall ist.
- Drücken Sie . Das Gerät wird gestartet, und statt dem Startsymbol wird jetzt das Stoppsymbol () angezeigt.

HINWEIS Es dauert 30 Sekunden, bis der Kompressor anläuft.

Überprüfen Sie nach dem Start alle externen Schlauchanschlüsse auf Dichtheit.

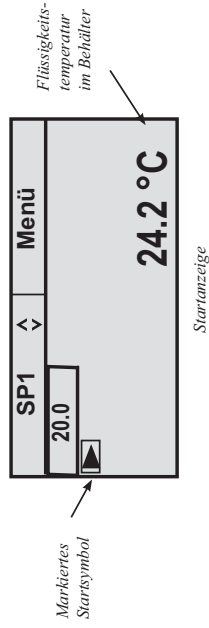

Über die Optionen **SP1** und **Menü** am oberen Bildschirmrand können die Reglereinstellungen angezeigt und/oder geändert werden. Sie werden ausführlich in der Gebrauchsanweisung erläutert.

Drücken Sie bei Bedarf auf , um die Statusanzeigen einzublenden.

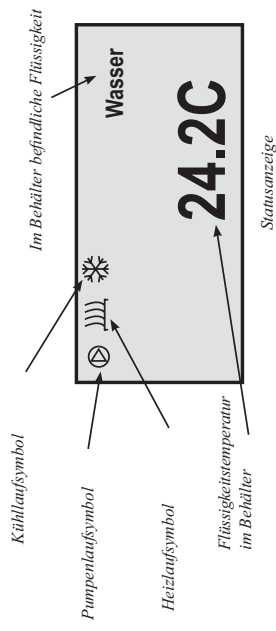

Drücken Sie bei Bedarf auf , um zwischen der Startanzeige und den Statusanzeigen umzuschalten.

Ausschalten

Achten Sie darauf, dass das Stopp-Symbol in einem Kästchen erscheint. Navigieren Sie mit den Pfeiltasten auf das Symbol, wenn dies nicht der Fall ist.

Drücken Sie . Das Gerät wird gestoppt, und statt dem Stoppsymbol wird jetzt das Startsymbol () angezeigt.

Drücken Sie . Das Thermostat-Display erlischt.

Schalten Sie den Netzschalter auf der Gerätevorderseite in die Stellung **O**.

Consignes de sécurité :

- Cet appareil est exclusivement destiné à une utilisation intérieure.
- Ne jamais l'exposer à une chaleur ou une humidité excessive, à une ventilation inadéquate ou à des matières corrosives.
- Ne jamais utiliser de liquides inflammables ou corrosifs avec cet appareil.
- Ne jamais raccorder les conduites de liquide de process à l'arrivée d'eau de votre site ou à une source de liquide sous pression.
- Avant d'utiliser un quelconque liquide ou d'effectuer des travaux d'entretien susceptibles d'entraîner un contact avec le liquide, consulter la fiche technique santé-sécurité du fabricant.

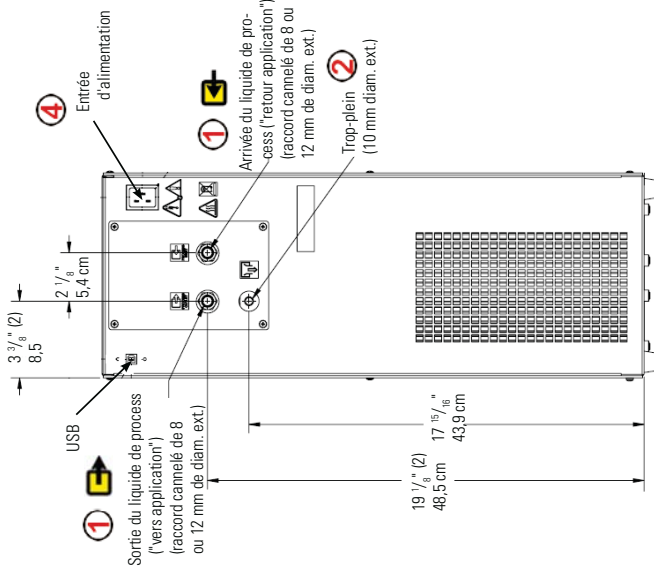

Matériel requis pour démonter :

- clé à molette
- flexible et matériel de plomberie approprié
- colliers de serrage ou raccord adaptateur de taille appropriée

1 Veiller à enlever tous les bouchons d'expédition avant l'installation.

Les raccords fluidiques se situent à l'arrière de l'appareil et sont étiquetés (SORTIE DE LIQUIDE "VERS APPLICATION") et (ARRIVÉE DE LIQUIDE "RETOUR APPLICATION"). Raccorder la SORTIE DE LIQUIDE DE PROCESS "VERS APPLICATION" à l'arrivée de liquide de l'application. Raccorder L'ARRIVÉE DE LIQUIDE DE PROCESS "RETOUR APPLICATION" à la sortie de liquide de l'application. S'assurer que tous les raccords sont bien serrés.

Maintenir la plus courte distance possible entre l'appareil et l'instrument refroidi. Pour minimiser la contre-pression, s'assurer que la tubulure est la plus droite possible. Si des réductions de diamètre s'imposent, les réaliser à l'arrivée et à la sortie de l'application, et pas du côté refroidisseur.

2 S'assurer que le bouchon est enlevé du réservoir overflow situé à l'arrière de l'unité de refroidissement et que le débordement est connecté à une vidange appropriée ou navire.

Tableau 1 – Liquides autorisés :

L'utilisation d'un quelconque liquide ne figurant pas dans la liste ci-dessous annule la garantie du fabricant.
5 à 80 °C — eau distillée ou désionisée (3 MQ-cm max.)
-10 à 80 °C — mélange eau/glycol 50/50

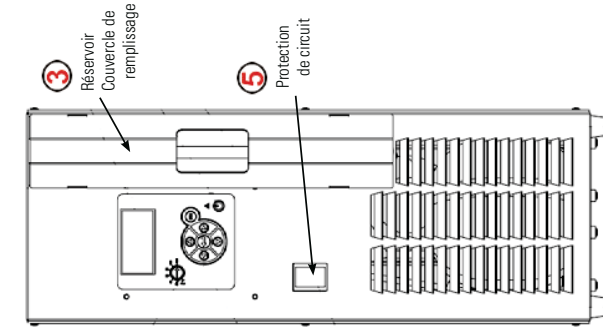

3 Soulever le panneau de remplissage sur l'avant de l'appareil pour l'enlever.

Démarrer avec 2,8 litres de liquide.

Insérer l'entonnoir fourni dans le flexible et ajouter *progressivement* du liquide. **REMARQUE** Étant donné la configuration de la plomberie de l'appareil, l'ajout trop rapide de liquide risque de causer un remplissage excessif - l'indication de niveau au repère de remplissage a un léger retard par rapport au volume ajouté.

Le versement de liquide dans l'entonnoir garantit que le liquide est tout d'abord en contact avec la paroi de l'entonnoir (A). Le versement de liquide au centre de l'entonnoir (B) cause des poches d'air et ralentit sensiblement le temps de remplissage.

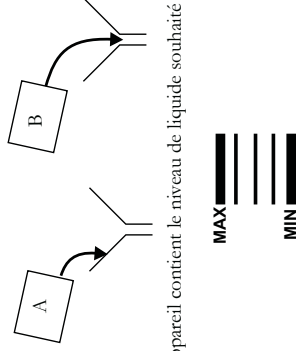

Vérifier si l'appareil contient le niveau de liquide souhaité d'après les repères.



La capacité du réservoir pouvant être réduite par rapport à l'application et de l'air pouvant être purgé des conduites, garder du liquide d'appoint à portée de la main pour faire le niveau du système une fois la circulation externe démarrée.

Éviter de trop remplir les récipients - les liquides se dilatent quand ils chauffent.

4 Vérifier si la tension est correcte. Pour les appareils fournis avec un cordon d'alimentation, insérer la prise femelle de ce dernier dans le refroidisseur et la prise mâle dans la prise secteur. (Le cordon d'alimentation se trouve sous le couvercle de la caisse d'expédition. Ne pas jeter le couvercle avant d'avoir localisé le cordon.)

5 Placer la protection de circuit en position (I).

Afin d'éviter d'endommager la tuyauterie du circulateur, utiliser une clé de maintien de 19 mm pour retirer/installer les connexions externes.

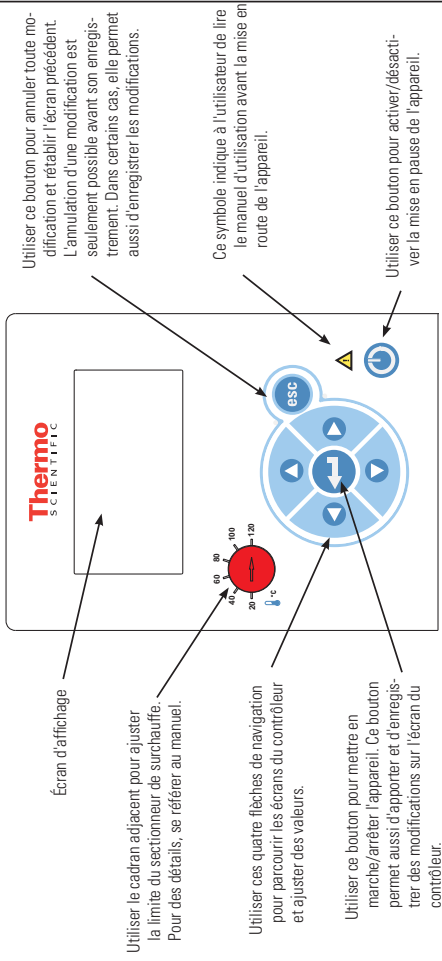

Mise en route



Les appareils doivent rester à la verticale à température ambiante (~25 °C) pendant 24 heures avant leur mise en marche. Ainsi, l'huile lubrifiante sera renvoyée au compresseur.

Avant de démarrer l'appareil, vérifier tous les connecteurs USB, électriques, et les raccords de plomberie.

Ne pas mettre l'appareil en marche sans liquide à l'intérieur. Avoir du liquide d'appoint sous la main. Si l'appareil ne démarre pas, se reporter au manuel.

- Placer la protection de circuit située à l'avant de l'appareil en position I.
- Appuyer sur  : l'écran de démarrage s'affiche.
- S'assurer que le symbole Marche est encadré d'une surbrillance ; sinon, utiliser les touches fléchées pour naviguer jusqu'au symbole.
- Appuyer sur  : L'appareil démarre et le symbole Marche est remplacé par le symbole Arrêt ().

REMARQUE Le démarrage du compresseur prend 30 secondes environ.

Après démarrage, vérifier l'étanchéité de tous les raccords de plomberie externes.

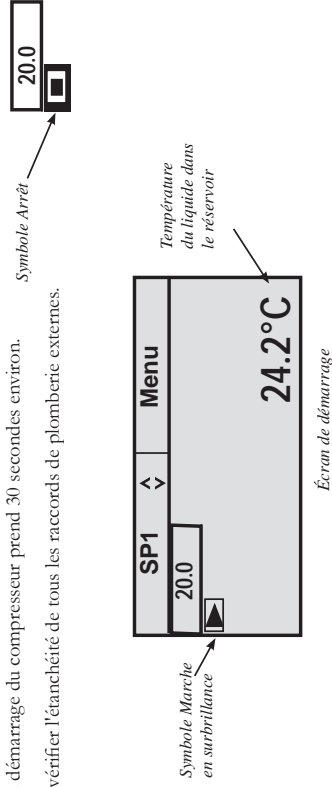

Les sections **SP1** et **Menu** en haut de l'écran permettent d'afficher et/ou de modifier les paramètres du contrôleur. Pour des détails, se référer au manuel.

Au besoin, appuyer sur  pour afficher les écrans d'état.

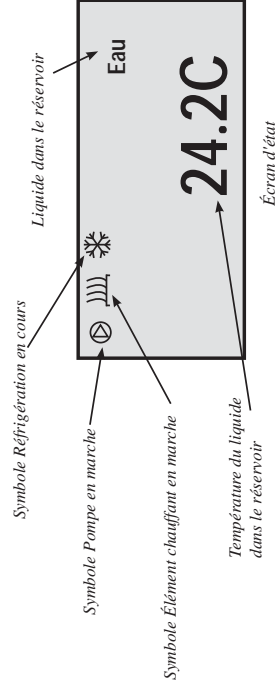

Au besoin, appuyer sur  pour basculer entre l'écran de démarrage et l'écran d'état.

Arrêt

S'assurer que le symbole Arrêt est encadré d'une surbrillance ; sinon, utiliser les touches fléchées pour naviguer jusqu'au symbole.

- Appuyer sur  : L'appareil démarre et le symbole Arrêt est remplacé par le symbole Marche ().
- Appuyer sur  : L'écran du thermostat s'éteint.

Placer la protection de circuit située à l'avant de l'appareil en position O.

Veiligheidsmaatregelen:

- De unit is alleen ontworpen voor gebruik binnenshuis.
- Plaats een unit nooit op een plek met overmatige warmte, vocht, onvoldoende ventilatie of corrosieve materialen.
- Gebruik nooit ontvlambare of corrosieve vloeistoffen met deze unit.
- Sluit nooit proces vloeistofleidingen aan op de gebouw water voorziening of andere vloeistofbronnen onder druk.
- Raadpleeg voordat u vloeistoffen gebruikt of onderhoud uitvoert op plekken waar mogelijk contact is met vloeistof, de veiligheidsbladen van de fabrikant voor voorzorgsmaatregelen.

Dit heeft u nodig om te kunnen beginnen:

- Een verstelbare steeksluitel
- Een geschikte slang of leiding
- Klemmen van de juiste grootte of type aansluiting

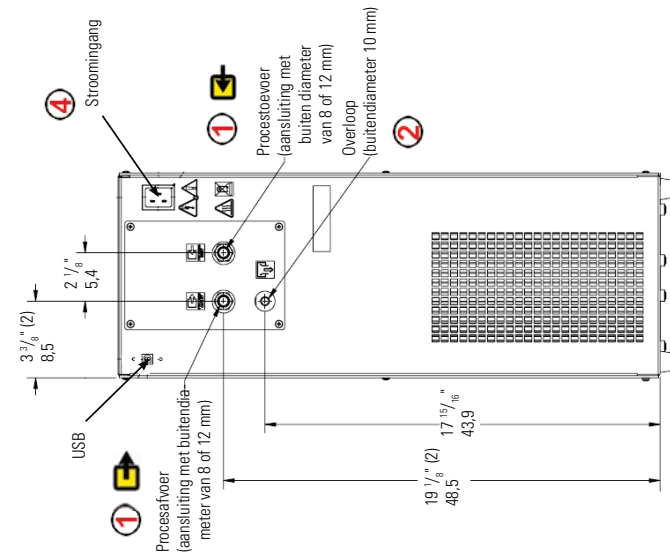

1 Zorg ervoor dat alle verzendpluggen verwijderd worden voor de installatie.

De aansluitingen voor de procesvloeistof bevinden zich op de achterzijde van de unit en zijn als volgt gelabeld: **PROCESSAFVOER** en **PROCESTOEVOER**.

Sluit de **PROCESAFVOER** aan op de vloeistofvoer op uw toepassing. Sluit de **PROCESTOEVOER** aan op de vloeistofvoer op uw toepassing. Zorg ervoor dat alle aansluitingen veilig zijn.

Houd de afstand tussen de unit en het instrument dat gekoeld wordt zo kort mogelijk. Zorg dat de leidingen zo recht mogelijk zijn om tegendruk zo klein mogelijk te houden. Als verkleiningen van de diameter vereist zijn, maak deze dan bij de toevoer en de afvoer van uw toepassing, niet bij de koeler.

2 Zorg ervoor, dat dekslet fjernes fra beholderen overløb placeret på bagenden af køleren og at overløbet er tilsluttet en passende dræn eller et skib.

Ter voorkoming van schade aan de koeler een watervoorzieningssysteem, gebruik dan een 19 mm back sleutel bij het verwijderen/aanbrengen van de externe aansluitingen.

Tabel 1 – Toegestane vloeistoffen:
Door gebruik van vloeistoffen die niet hieronder worden vermeld komt de fabrieksgarantie te vervallen.
5°C tot 80°C — Gedestilleerd of gedetonneerd water (tot maximaal 3 MΩ·cm)
-10°C tot 80°C — 50/50 water met glycol

3 Til het vulpaneel op de voorkant van de unit op om het te verwijderen.

Begin met 2,8 liter vloeistof.

Steek de bijgeleverde trechter in de slang en voeg *langzaam* vloeistof toe. **OPMERKING** Door de configuratie van de leidingen van de unit kan het te snel toevoegen van vloeistof leiden tot overvulling - de indicatie van het vulniveau blijft dan achter bij de werkelijk toegevoegde hoeveelheid.

Wanneer u vloeistof in de trechter giet, moet u ervoor zorgen dat de vloeistof eerst de kant van de trechter raakt, A. Als u de vloeistof in het midden van de trechter giet, B, kunnen er luchtzakken ontstaan en kost het vullen aanzienlijk meer tijd.

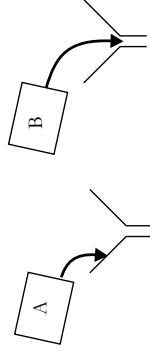

Controleer het gewenste vloeistofniveau met behulp van de vullijnen.



Aangezien de capaciteit van het reservoir klein kan zijn in vergelijking tot uw toepassing en het nodig kan zijn dat er lucht uit de leidingen geblazen moet worden, dient u extra koelvloeistof bij de hand te houden om het systeem bijgevuld te houden als de uitwendige circulatie wordt gestart.

Vul het reservoir niet te vol; vloeistoffen zetten uit bij verwarming.

4 Controleer de juiste spanning. Voor units die worden geleverd met een netsnoer, steek de vrouwelijke kant van de stroomkabel in de koeler en steek de mannelijke kant van de stroomkabel in de vermogensuitgang. (Het netsnoer bevindt zich onder de deksel van de transportdoos. Gooi het deksel niet weg voordat u het snoer heeft gevonden.)

5 Zet de stroombeschermer op de aan (I) -stand.

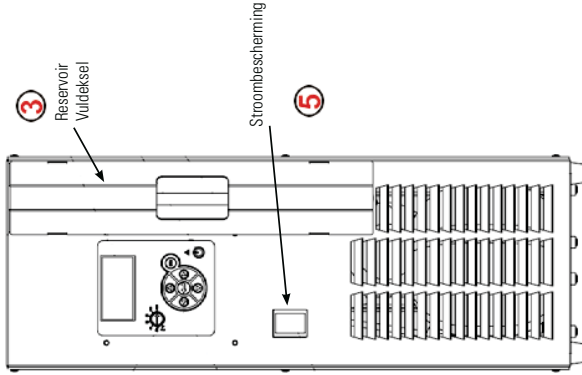

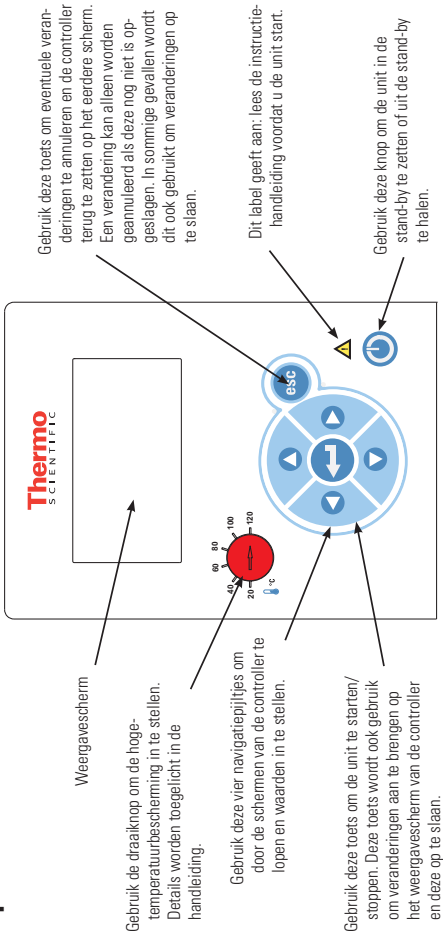

Opstarten



Units moeten gedurende 24 uur voordat ze gestart worden rechtop staan bij kamertemperatuur (~25°C). Hierdoor wordt gegarandeerd dat de smeerolie teruggelopen is in de compressor.

Controleer voordat u de unit start alle USB en elektrische aansluitingen en de aansluitingen van de vloeistofleidingen.

Schakel de unit niet in voordat u vloeistof heeft toegevoegd. Houd extra vloeistof bij de hand. Als de unit niet start, raadpleeg dan de handleiding.

- Zet de stroombeschermer op de voorkant van de unit in de **I**-stand.
- Druk op , het Startscherm verschijnt.
- Controleer of het startsymbool gemarkeerd is; als dit niet het geval is, gebruik dan de pijltoetsen om naar het symbool te navigeren.
- Druk op . De unit start en het startsymbool verandert in een stopsymbool ().

OPMERKING

Het duurt 30 seconden voordat de compressor start. Controleer na het starten alle externe leidingen op lekken.

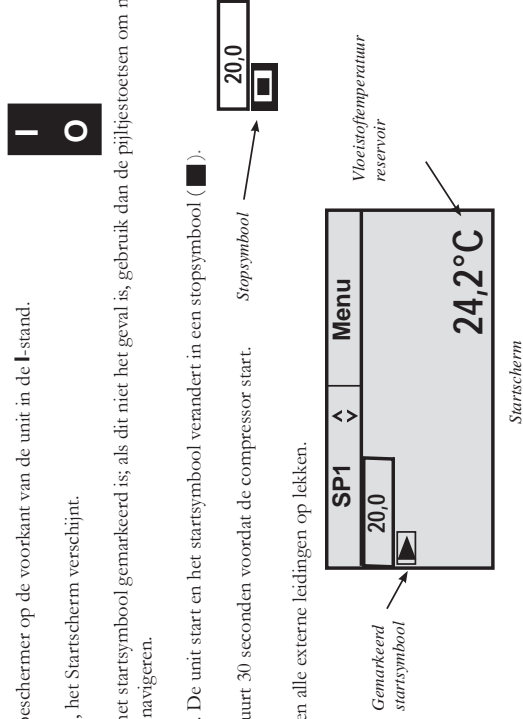

De gedeeltes **SP1** en **Menu** bovenaan het scherm worden gebruikt om de instellingen van de controller af te lezen bekijken en/of te wijzigen. Deze worden uitgebreid beschreven in de handleiding.

Druk indien gewenst op  om de statusschermen te openen.

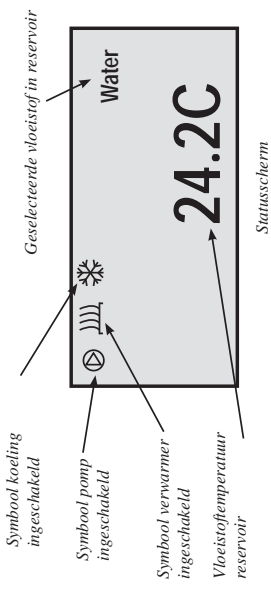

Druk indien gewenst op  om heen en weer te gaan tussen de start-/ statusschermen.

Uitschakelen

Controleer of het stopsymbool gemarkeerd is; als dit niet het geval is, gebruik dan de pijltoetsen om naar het symbool te navigeren.

Druk op . De unit stopt en het stopsymbool verandert in een startsymbool ().

Druk op . Het thermostaatscherm wordt blanco.

Zet de stroombeschermer op de voorkant van de unit in de **O**-stand.



Scopo di questa guida rapida è facilitare la messa in funzione iniziale. Per tutte le altre procedure è necessario fare riferimento al manuale. Se alcuni dei passaggi qui riportati non risultano chiari, scaricare il manuale prima di proseguire.

Sicurezza:

- Il refrigeratore è progettato esclusivamente per l'uso, al chiuso. Non posizionare mai il refrigeratore in un ambiente a temperature eccessivamente alte, umido, con ventilazione inadeguata o materiali corrosivi.
- Attaccare il refrigeratore a una presa correttamente collegata a massa.
- I refrigeranti utilizzati sono più pesanti dell'aria e sostituiranno l'ossigeno causando la perdita di coscienza. Il contatto con refrigeranti fuoriusciti causa ustioni della pelle. Per ulteriori informazioni, fare riferimento alla targhetta identificativa del refrigeratore e alla scheda di sicurezza dei materiali (MSDS) più recente.
- Spostare il refrigeratore con cautela. Cadute o urti improvvisi possono danneggiarne i componenti. Spegnerne sempre l'apparecchiatura e scollegarla dalla tensione di alimentazione, prima di spostarla.

- La protezione di circuito serve a proteggere il refrigeratore. Il cavo di alimentazione del refrigeratore è progettato per funzionare come dispositivo di interruzione; posizionare il refrigeratore in modo tale che il cavo possa essere raggiunto con facilità.
- Non azionare apparecchiature danneggiate o che presentino perdite.
- Onde evitare danni alle tubature del refrigeratore, usare una controchiave da 19 mm per la rimozione/l'installazione dei collegamenti esterni.
- Utilizzare solo i liquidi approvati riportati nella tabella 1. Prima di utilizzare liquidi o eseguire eventuali interventi di manutenzione che potrebbero implicare il contatto con il liquido, fare riferimento alle schede di sicurezza dei materiali (MSDS) del produttore per le precauzioni d'uso.
- Lasciare i refrigeratori in posizione verticale a temperatura ambiente (~25 °C) per 24 ore prima dell'avvio. Questa operazione garantisce il riporto dell'olio lubrificante nel compressore.

Tabella 1 - Liquidi di processo approvati: L'uso di qualsiasi altro liquido annullerà la garanzia del produttore.	
Da +5 °C a +80 °C	Acqua distillata/filtrata (pH 7-8)
	Acqua demineralizzata (massimo 1 MQ-cm, compensata)
	Acqua distillata con bicoida o inibitore Nalco
	Acqua distillata con cloro (5 ppm)
Da -10 °C a 80 °C	0 - 50% etilenglicole/acqua per laboratorio

Elementi necessari per la messa in funzione:

- Liquidi approvati
- Chiavi regolabili
- Tubature adeguate
- Tipologia di fascette o collegamenti di dimensioni adeguate

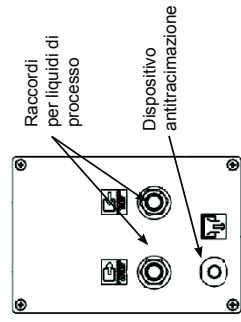

Assicurarsi che i tappi di spedizione siano stati rimossi dai raccordi delle tubature prima di procedere all'installazione.

I raccordi flangiati per il liquido di processo con diametro esterno di 8 o 12 mm sono posizionati nella parte posteriore del refrigeratore e sono etichettati con (uscita di processo) e (ingresso di processo). Collegare l'uscita di processo all'ingresso liquidi dell'apparecchiatura. Collegare l'ingresso di processo all'uscita liquidi dell'apparecchiatura. Accertarsi che tutti i collegamenti siano ben fissati.

Mantenere la più breve distanza possibile tra il refrigeratore e lo strumento da raffreddare. Per ridurre al minimo la contropressione, assicurarsi che il tubo sia il più dritto possibile. Se è necessario ridurre il diametro, procedere alla restrizione all'ingresso e all'uscita dell'apparecchiatura, non del refrigeratore.

Assicurarsi che il tappo è rimosso dal serbatoio di troppo pieno e che il troppo pieno è collegato ad un idoneo scarico o nave. Assicurarsi che il tappo è rimosso dal serbatoio di troppo pieno e che il troppo pieno è collegato ad un idoneo scarico o nave.

Inserire l'imbuto fornito in dotazione nel tubo e aggiungere il liquido lentamente, iniziando con 2,8 litri. Data la conformazione delle tubature del refrigeratore, un'aggiunta troppo rapida del liquido potrebbe determinare una trascinazione (l'indicazione del livello di riempimento è inferiore rispetto alla quantità realmente inserita).

Quando si versa il liquido nell'imbuto, assicurarsi che il liquido entri dapprima in contatto con le pareti dell'imbuto, A. L'inserimento del liquido direttamente al centro dell'imbuto, B, determina la creazione di sacche d'aria e allunga in maniera sostanziale il tempo di riempimento.

Usare gli indicatori di riempimento per verificare il livello di riempimento desiderato. Poiché la capacità del serbatoio potrebbe essere inferiore al necessario per l'apparecchiatura interessata e potrebbe essere necessario spurgare l'aria dalle tubazioni, tenere a portata di mano del liquido di raffreddamento di riserva per rabboccare il sistema all'avvio del ricircolo esterno.

Non riempire eccessivamente; i liquidi si espandono quando riscaldati.

Assicurarsi che la protezione di circuito sia in posizione off (O). Per i refrigeratori dotati di cavo di alimentazione, inserire l'estremità femmina del cavo di alimentazione nel refrigeratore e l'estremità maschio nella presa di corrente. (Il cavo di alimentazione si trova sotto il coperchio della cassa per la spedizione. Non gettare il coperchio fino a quando non si trova il cavo.)

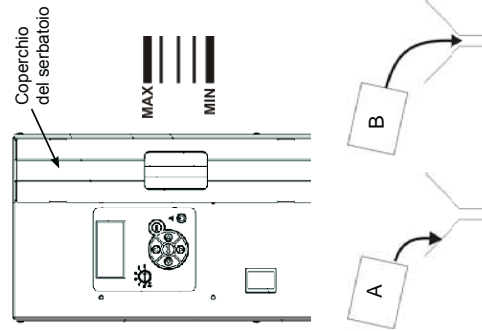

Non azionare il refrigeratore prima di aver aggiunto il liquido nel serbatoio. Tenere del liquido di riserva a portata di mano.

Fare riferimento alla targhetta identificativa per i requisiti elettrici specifici. Sono ammesse deviazioni di tensione di $\pm 10\%$. La presa deve essere ritenuta idonea per il consumo di energia totale.

Portare la protezione di circuito in posizione (I).

Premere **ESC**; viene visualizzato il Display avvio.

Assicurarsi che il simbolo di avvio **▶** sia evidenziato; in caso contrario usare i tasti di direzione per spostarsi sul simbolo.

Premere **ESC**. Il refrigeratore si avvia e il simbolo di avvio si trasforma in un simbolo di interruzione **■**. La pompa si avvia immediatamente, mentre per il compressore sono necessari 30 secondi.

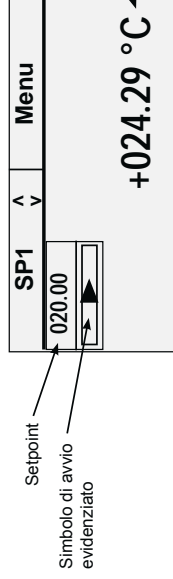

Se lo si desidera, premere **ESC** per visualizzare il Display stato. Premere **ESC** per alternare i Display avvio/stato.

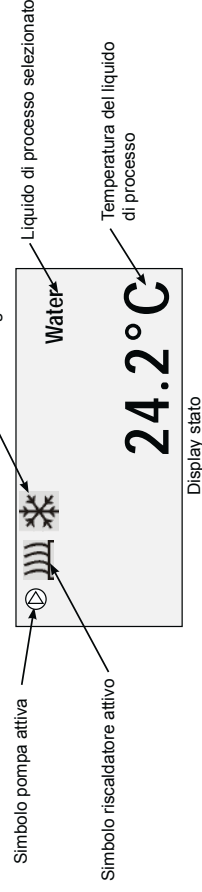

Dopo l'avvio, controllare tutti i collegamenti dei tubi per escludere eventuali perdite. Regolare il dispositivo di sicurezza HTC (High Temperature Cutout); fare riferimento al manuale.



Den här snabbstartguiden är endast avsedd att användas vid den första starten. För övriga procedurer ska du läsa handboken. Om du är osäker på något av nedanstående steg ska du också ladda ned och läsa handboken innan du fortsätter.

Säkerhet:

- Kylsystemet är endast avsett för inomhusbruk. Placera aldrig kylsystemet på ett ställe som är onormalt varmt, luftigt eller dåligt ventilerat, eller där frätande material förekommer.
- Anslut kylsystemet till ett jordat eluttag.
- Kylmediet som används är tyngre än luft och tränger undan syret, vilket leder till medvetlöshet. Ett läckande kylmedium orsakar brännskador om det kommer i kontakt med huden. Läs märkplåten på kylsystemet och det senaste databladets om materialsäkerhet från tillverkaren för mer information.
- Var försiktig när du flyttar kylsystemet. Plötsliga skakningar eller fall kan skada dess komponenter. Stäng alltid av utrustningen och dra ut nätsladden innan du flyttar den.
- Kretsskyddets funktion är att skydda kylsystemet. Nätsladden till kylsystemet fungerar som en fränkopplingsenhet. Placera kylsystemet så att du enkelt kommer åt nätsladden.
- Använd aldrig utrustning som är skadad eller läcker.
- För att undvika skador på kylsystemets rör ska en säkerhetsnyckel på 19 mm användas när de externa anslutningarna tas bort eller installeras.
- Använd endast de godkända vätskor som visas i tabell 1. Innan du använder någon vätska eller utför underhåll där vätska kan tänkas komma i kontakt med huden ska du läsa databladet om materialsäkerhet från tillverkaren om hanteringsrutiner.
- Låt kylsystemen stå i upprätt läge i rumstemperatur (ca 25 °C) i 24 timmar före start. Detta säkerställer att smörjolja har runnit tillbaka in i kompressorn.

Du behöver följande för att komma igång:

- godkänd vätska
- skiftnycklar
- lämpliga slangar eller rör
- klämmor av lämplig storlek eller anslutningstyp.

Säkerställ att transportluggar tas bort från röranslutningar före installation.

Slanginppar för processvätska med en yttre diameter på 8 eller 12 mm sitter på baksidan av kylsystemet och är märkta med (processutlopp) och (processingång). Anslut processutloppet till vätskans inlopp på din applikation. Anslut processingången till utloppet för vätskan på din applikation. Se till att alla anslutningar är säkra.

Håll avståndet mellan kylsystemet och det instrument som kyla så kort som möjligt. Se till att slangen är så rak som möjligt för att minimera mottryck. Om diameternskenningar är nödvändiga, gör dem vid in- och utloppet till din applikation, inte på kylsystemet.

Se till att locket är borttaget från behållaren svämmar över på baksidan av kylaggregatet och att svämma över är ansluten till en lämplig dränering eller fartyg.

Ljft upp påfyllningspanelen på framsidan av kylaren och ta bort den.

Sätt i den medföljande tratten i slangen och tillsätt vätskan långsamt. Börja med 2,8 liter. Kylsystemets rör är konfigurerade så att för snabb påfyllning av vätska resulterar i att för mycket vätska fylls på – indikationen för fyllnadsnivån är fördröjd i förhållande till den faktiska mängden som tillsätts.

När du håller vätska i tratten mätte du se till att vätskan kommer i kontakt med sidan av tratten först, A. Om vätskan hälls i mitten av tratten, B, bildas luftfickor och det tar betydligt längre tid att fylla på vätskan.

Kontrollera den önskade vätskenivån med hjälp av påfyllningslinjerna.

Eftersom behållarens kapacitet kan vara liten i förhållande till din applikation, och luft kan behöva rensas bort från ledningarna, ska du ha extra kylvätska till hands så att du kan fylla på systemet när extern cirkulation startas.

Undvik överfyllning; vätskor expanderar när de värms upp.

Se till att kretsskyddet är i avstängt (**O**) läge.

För kylsystem som levereras med en anslutningskabel, sätter du in honöden av nätkabeln i kylsystemet och därefter hanöden av nätkabeln i eluttaget. (Anslutningskabeln sitter under transportlådans lock. Släng inte locket förrän kabeln har hittats)

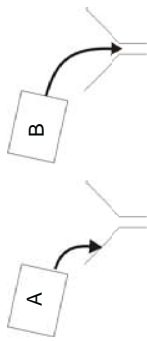
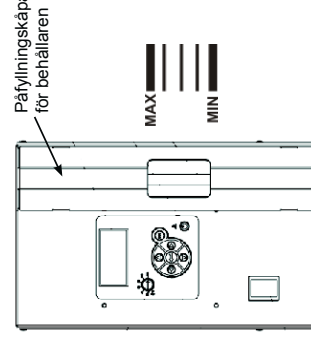
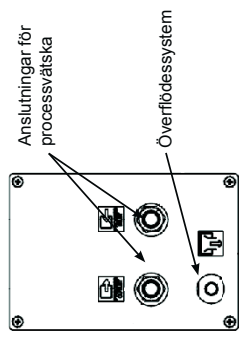

Tabell 1 – godkända processvätskor:
Om någon annan vätska används gäller inte tillverkarens garanti.

+5 °C till +80 °C
Filtrerat/enkeldestillerat vatten (pH 7-8)
Avjoniserat vatten (max 1 MΩ-cm, kompenserat)
Destillerat vatten med Nalco-biocid-hämmare
Destillerat vatten med klor (5 ppm)
-10 °C till 80 °C
0-50 % laboratorieklassad etylenglykol/vatten

Starta inte kylsystemet förrän vätska har fyllts på i behållaren. Se till att ha extra vätska till hands.

Se märkplåten för specifika elektriska krav. Spänningsavvikelser på ± 10 % är tillåtna. Eluttaget måste vara klassat som lämpligt för den totala strömförbrukningen.

Sätt kretsskyddet i påslaget (**I**) läge.

Tryck på så visas startdisplayen.

Kontrollera att startsymbolen lyser. Om den inte gör det använder du pilangenterna till att navigera till symbolen.

Tryck på . Kylsystemet startar och startsymbolen ändras till en stoppsymbol . Pumpen startar direkt, men för kompressorn tar det 30 sekunder.

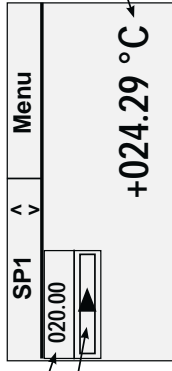

Börvärde

Startsymbol som lyser

Startdisplay

Processvätskans temperatur

Om du vill kan du trycka på för att visa statusdisplayen. Tryck på för att växla mellan start- och statusdisplayen.

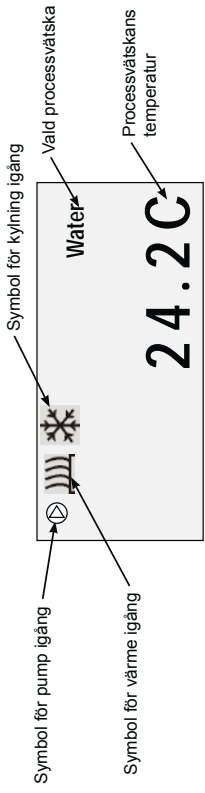

Symbol för pump igång

Vald processvätska

Symbol för värme igång

Processvätskans temperatur

Statusdisplay

Efter start ska alla röranslutningar kontrolleras så att de inte läcker.

Justera säkerhetsnheten för avstängning vid höga temperaturer (High Temperature Cutout, HTC) enligt anvisningarna i handboken.



Bu hızlı başlangıç kılavuzu yalnızca ilk çalıştırma prosedürüne yöneliktir. Diğer tüm prosedürler için kılavuza bakın. Ayrıca, burada yer alan adımları ilgili emin olmadığınız noktalar varsa devam etmeden önce kılavuzu indirin.

Güvenlik:

- Soğutucu yalnızca kapalı mekanda kullanıma yöneliktir. Soğutucuyu hiçbir zaman aşırı sıcak, nemli, yeterli havalandırması olmayan veya aşırı malzeme bulunan bir ortama yerleştirmeyin.
- Soğutucuyu uygun şekilde topraklanmış bir prize bağlayın.
- Kullanılan soğutucu akışkanlar, havadan ağır oldukları için ortamdaki oksijenin yerine geçerek bilinç kaybına yol açabilir. Sızan soğutucu akışkanlara temas edilmeli cilt yanıklarına yol açar. Ek bilgi için soğutucunun ad plakasına ve üreticinin en güncel Malzeme Güvenlik Bilgi Formuna (MSDS) bakın.
- Soğutucuyu dikkatli bir şekilde taşıyın. Ani sarsıntılar ve ürünün düşürülmesi bileşenlere zarar verebilir. Ekipmanı taşımadan önce mutlaka kapatın ve şebeke bağlantısını kesin.

Başlangıç için gerekli malzemeler:

- Onaylı sıvı
- Ayarlanabilir İngiliz anahtarları
- Uygun hortum veya boru bağlantıları
- Uygun boyda kelepçeler veya bağlantı tipi

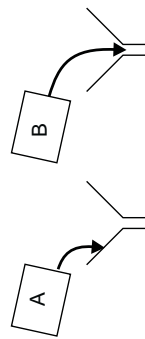
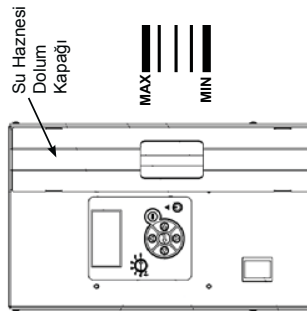
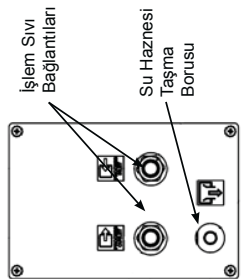

- Devre koruması, soğutucunun korunması için tasarlanmıştır. Soğutucunun hat kablosu, bağlantı kesme aracı olarak kullanılmak üzere tasarlanmıştır; soğutucuyu kabloya rahatsızlıkla erişilebilecek bir şekilde konumlandırın.
- Hasarlı veya sızıtı yaparı ekipmanı asla çalıştırmayın.
- Soğutucu borularının zarar görmesini önlemek için harici bağlantıları sökerek/takarken destek anahtarları olarak 19 mm'lik anahtar kullanın.
- Yalnızca Tablo 1'de gösterilen onaylı sıvıları kullanın. Sıvıya temas etme ihtimali olan yerlerde herhangi bir sıvı kullanılmadan veya bakım yapmadan önce kullanıma ilgili önlemler hakkında bilgi almak için üreticinin MSDS belgesine bakın.
- Soğutucuları, çalıştırmadan önce oda sıcaklığında (~25°C'de) dış konumda 24 saat süreyle beklemeye bırakın.

Bu şekilde yağlama yağı tekrar kompresöre boşaltılmış olur.

Kırılmadan önce nakliye tapalının boru bağlantılarından çıkarıldığını emin olun.

İşlem sıvısı 8 veya 12 mm OD uç bağlantıları soğutucunun arkasında yer alır ve (işlem çıkış noktası) ile (işlem giriş noktası) olarak etiketlenmiştir. İşlem çıkış noktasını uygulamamızdaki (işlem çıkış noktası) sıvı giriş noktasına bağlayın. İşlem giriş noktasını uygulamamızdaki (işlem giriş noktası) sıvı çıkış noktasına bağlayın. Tüm bağlantıların güvenli olduğundan emin olun.

Soğutucu ile soğutulan cihaz arasındaki mesafeyi olabildiğince kısa tutun. Arka basıncı en aza indirmek için hortumların olabildiğince düz olduğundan emin olun. Çapın azaltılması gerekiyorsa bunu soğutucuda değil, uygulamamızdaki giriş ve çıkış noktalarında yapın.

Emin olun, kapağı, deposu taşma ve taşması, uygun bir tabliye veya damar-emin olun ve kapağı, deposu taşma ve taşması, uygun bir tabliye veya damar.

Soğutucunun önündeki doldurma panelini çıkarmak için yukarı kaldırın.

Tedatit edilen huniyi hortuma yerleştirin ve 2.8 fitreden başlayarak sıvı yavaşça ekleyin. Soğutucunun boru yapılandırması nedeniyle sıvının çok hızlı eklenmesi, cihazın fazla doldurulmasına sebep olabilir ve doluluk oranı göstergesi, eklenen miktardan göstermekte gecikir.

Sıvıyı humiden dökerken sıvının ilk önce huninin kenarlarına (A) değiştiğinden emin olun. Sıvıyı huninin ortasından (B) dökmek, hava ceplerinin oluşmasına neden olur ve doldurma süresini büyük ölçüde yavaşlatır.

Doldurma çizgilerinden yararlanarak, istenen sıvının istenen seviyede doldurulduğuna doğrulayın.

Su haznesinin kapasitesi uygulamamızın kapasitesine göre az olabileceği ve havanın hatlardan dışarı atılması gerekebileceğinden, harici sirkülasyon başladığında sistemin tamamen sıvıyla dolu olması için hazırdaki fazladan soğutma sıvısı bulunmalıdır.

Aşırı sıvı doldurmayın; sıvılar ısındığında genişler.

Devre koruyucusunun kapalı konumunda (O) olduğundan emin olun.

Hat kablosuyla birlikte sağlanan soğutucularda, güç kablosunun dışı ucunu soğutucunun içine yerleştirin; ardından güç kablosunun erkek ucunu güç çıkış noktasına bağlayın. (Hat kablosu nakliye kutusunun kapagının altındadır. Kablo bulunana kadar kapagı atmayın.)

Tablo 1 - Onaylı İşlem Sıvıları:

Başka herhangi bir sıvı kullanılması durumunda üretici garantisizdir.

+5°C İla +80°C

Filtrelenmiş/koz damıtılmış su (pH 7-8)

Deiyonize su (maksimum 1 MΩ-cm, dengelenmiş)

Nalco biyosit ve inhibitör eklenmiş damıtılmış su

Klor eklenmiş damıtılmış su (5 ppm)

-10°C İla 80°C

%0 – 50 Laboratuvar Sınıfı Etilen Glköl/Su

Su haznesine sıvı eklenmeden soğutucuyu çalıştırmayın. Hazırdaki fazladan sıvı bulunur.

Spesifik elektrik gereksinimleri için ad plakasına bakın. ± %10'luk gerilim sapmalarına izin verilir. Priz, toplam güç tüketimine uygun değerde olmalıdır.

Devre koruyucusunu açık (I) konuma getirin.

⏪ düğmesine basın, Başlangıç Ekranı görüntülenir.

Başlat simgesinin (▶) vurgulandığından emin olun; simge vurgulanıyorsa ok tuşlarını kullanarak simgeye gidin.

⏩ düğmesine basın. Soğutucu çalışır ve başlat simgesi durdur simgesine (■) döner. Pompa derhal çalışır, fakat kompresörün çalışması 30 saniye kadar sürer.

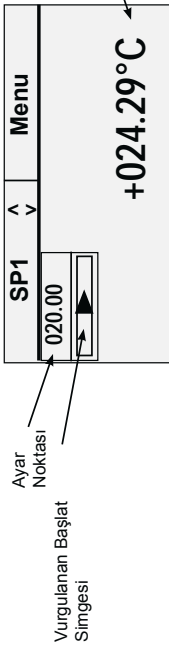

İsterseniz (esc) düğmesine basarak Durum Ekranını görüntüleyebilirsiniz. Başlangıç/Durum Ekranları arasında geçiş yapmak için (esc) düğmesine basın.

İsterseniz (esc) düğmesine basarak Durum Ekranını görüntüleyebilirsiniz. Başlangıç/Durum Ekranları arasında geçiş yapmak için (esc) düğmesine basın.

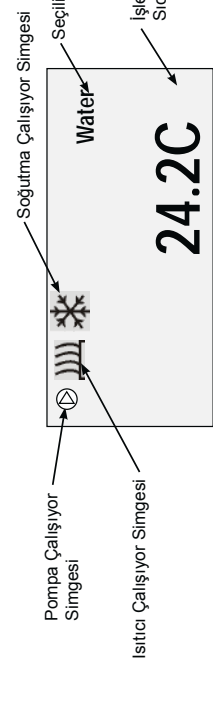

Ürünü çalıştırdıktan sonra sızıntı olup olmadığını belirlemek için tüm boru bağlantılarını kontrol edin.

Yüksek Sıcaklık Kapatma (HTC) güvenlik cihazını ayarlayın; kılavuza bakın.

Preface

Compliance

The Declarations of Conformity is located in the back of this manual.

WEEE

This product is required to comply with the European Union's Waste Electrical & Electronic Equipment (WEEE) Directive 2012/19/EU. It is marked with 'wheelie bin' symbol:



Thermo Fisher Scientific has contracted with one or more recycling/disposal companies in each EU Member State, dispose of or recycle this product through them. Further information on Thermo Fisher Scientific's compliance with these Directives is available at:

www.thermoscientific.com/WEEERoHS

After-sale Support

Thermo Fisher Scientific is committed to customer service both during and after the sale. If you have questions concerning the chiller operation, or questions concerning spare parts or Service Contracts, call our Sales, Service and Customer Support. Phone number are on the inside cover.

Before calling, please obtain the serial number printed on the nameplate located on the upper rear of the chiller.

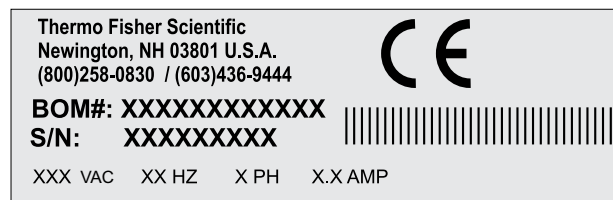

Sample Nameplate

Warranty

Thermo Scientific Cooling/Heating Recirculating Chillers have a warranty against defective parts and workmanship for 24 months from date of shipment. See back page of this manual for more details.

Unpacking

Retain all cartons and packing material until the chiller is operated and found to be in good condition. If the chiller shows external or internal damage contact the transportation company and file a damage claim. Under ICC regulations, this is your responsibility.



The chiller does not have handles. Take into account its weight, 66 pounds (30 kilograms), when unpacking and transporting. We recommend two people lift the chiller from the bottom. ▲

Note Leave chillers in an upright position at room temperature ($\sim 25^{\circ}\text{C}$) for 24 hours before starting. This ensures the lubrication oil has drained back into the compressor. ▲

Feedback

We appreciate any feedback you can give us on this manual. Please e-mail us at tcmanuals@thermofisher.com. Be sure to include the manual part number and the revision date on the front cover.

Section 1 Safety

Safety Warnings

Make sure you read and understand all instructions and safety precautions listed in this manual before installing or operating your chiller. If you have any questions concerning the operation of your chiller or the information in this manual, please contact us.



DANGER indicates an imminently hazardous situation which, if not avoided, *will* result in death or serious injury.



WARNING indicates a potentially hazardous situation which, if not avoided, *could* result in death or serious injury.



CAUTION indicates a potentially hazardous situation which, if not avoided, may result in minor or moderate injury. It is also be used to alert against unsafe practices.



The lightning flash with arrow symbol, within an equilateral triangle, is intended to alert the user to the presence of non-insulated "dangerous voltage" within the chiller's enclosure. The voltage magnitude is significant enough to constitute a risk of electrical shock.



This label indicates the presence of hot surfaces.



This label indicates read the manual.

Note The chiller's equipment design incorporates a complete sheet metal enclosure for personnel protection from mechanical and electrical hazards. ▲

Observe all warning labels. ▲

Never remove warning labels. ▲

The chiller's construction provides protection against the risk of electrical shock by grounding appropriate metal parts. The protection will not function unless the power cord is connected to a properly grounded outlet. It is the user's responsibility to assure a proper ground connection is provided. ▲

Operate the chiller using only the supplied line cords, never operate equipment with damaged cords. ▲

Ensure all communication and electrical connections are made prior to starting the chiller. ▲

The chiller's power cord is the electrical disconnecting device, it must be easily accessible at all times. ▲

Always turn the chiller off and disconnect the supply voltage from its power source before moving performing any service or maintenance procedures. Ensure chiller is at a safe temperature (~40°C) before handling or draining. ▲

Never place the chiller in a location or atmosphere where excessive heat, moisture, or corrosive materials are present. ▲

Leave chillers in an upright position at room temperature (~25°C) for 24 hours before starting. This ensures the lubrication oil has drained back into the compressor. ▲

The chiller is not designed to be floor mounted. ▲

Other than water, before using any fluid, or when performing maintenance where contact with the fluid is likely, refer to the manufacturer's MSDS and EC Safety Data sheet for handling precautions. ▲

Ensure, that no toxic gases can be generated by the fluid. Flammable gases can build up over the fluid during usage. ▲

Never operate the chiller without fluid in the reservoir. ▲

Only use approved fluids with this chiller. Use of any other fluids voids the manufacturer's warranty. ▲

The user is responsible for decontamination if hazardous materials are spilled. Consult the manufacturer regarding decontamination and or cleaning agents compatibility. ▲

Drain the chiller before it is transported and/or stored in near or below freezing temperatures, see Draining in Section 3. ▲

Ensure the tubing you select meets your maximum temperature and pressure requirements. ▲

Never operate damaged or leaking equipment. ▲

Never operate the chiller or add fluid to the reservoir with panels removed. ▲

Transport the chiller with care. Sudden jolts or drops can damage its components. ▲

Do not clean the chiller with solvents, only use a soft cloth and water. ▲

Refer service and repairs to a qualified technician. ▲

Performance of installation, operation, or maintenance procedures other than those described in this manual may result in a hazardous situation and voids the manufacturer's warranty. ▲

Element Assessment

Chemical Used —

R134A Refrigerant - CFC Free

Amount: 178 grams (6.7 ounces)

Location: Refrigeration system

Lubricating Oil: Polyol Ester

Amount: 243 milliliters (8.2 ounces)

Location: Compressor

Hazard Communication — None

Electrical — All electrical energy sources for the chiller are provided by the user.

Hazardous Energy Isolation — Locate energy isolation devices in a location that is readily accessible.

Electrical Remove power from the chiller by turning the circuit protector off and disconnecting the line cord, see Section 3 **Electrical Requirements**.

Fluid Before using any fluid refer to the manufacturer's MSDS and EC safety data sheets for handling precautions. The user is responsible to ensure the reservoir overflow located on the rear of the chiller is connected to a suitable drain.

Refrigeration The chiller's refrigeration system is sealed and requires no lockout/tagout.

Remove any isolation devices before starting the chiller.

Chemicals — Prior to decontamination, develop and employee procedures to minimize or mitigate opportunities for exposure to chemicals present in or around the chiller.

Radioactive Material — None

Magnetic Fields — None

Sampling and Analysis for External Contaminants from Other Sources or from Spill Events

It is the responsibility of the user to identify the presence of all external chemicals before the decontamination. Accomplish this by collecting samples and analyzing them for any suspected chemicals used or stored in areas adjacent to the chiller.

Oxygen Deficiency — Many refrigerants which may be undetectable by human senses are heavier than air and will replace the oxygen in an enclosed area causing loss of consciousness. Refer to the chiller's nameplate and the manufacturer's most current MSDS for additional information. Test the atmosphere in a confined space area or area where gases are being used to purge the chiller. If necessary, use an air supplied respirator.

Personal Protective Equipment

The are no special personal protective equipment requirements needed to perform normal operation. We do recommend wearing protective clothing and using eye protection.

Training

The user must review and understand all the sections in this manual before operating the chiller.

Grundlegende Sicherheitsanweisungen Umwälzkühler

Falls Sie eine dieser Anweisungen nicht verstehen, lesen Sie das Handbuch oder kontaktieren Sie uns bevor Sie fortfahren.

Sicherheit, alle Produkte:

 weist auf eine unmittelbar gefährliche Situation hin, die, falls sie nicht vermieden wird, zum Tod oder schweren Verletzungen führt.

 weist auf eine potenziell gefährliche Situation hin, die zu ernsthaften Verletzungen oder zum Tod führen kann, wenn sie nicht vermieden wird.

 weist auf eine potenziell gefährliche Situation hin, die, falls sie nicht vermieden wird, zu leichteren bis mittelschweren Verletzungen führen kann. Es kann auch verwendet werden, um gegen unsichere Praktiken zu warnen.

 ist dafür vorgesehen, den Benutzer vor dem Bestehen einer nicht isolierten "gefährlichen Spannung" im Gehäuse des Kühlers zu warnen. Die Höhe der Spannung ist bedeutend genug, sodass ein Stromschlag-Risiko besteht.

 weist auf das Vorhandensein heißer Oberflächen hin.

 weist darauf hin, das Handbuch zu lesen.

Benutzen Sie das Gerät keinesfalls als steriles oder an Patienten angeschlossenes Gerät. Außerdem ist das Gerät nicht für den Gebrauch an Orten mit Gefahrenklasse I, II oder III, wie in den nationalen Vorgaben für elektrische Geräte definiert, ausgelegt.

Das Gerät ist nur für den Gebrauch in Innenräumen ausgelegt. Stelle Sie es niemals an einen Ort wo übermäßige Temperaturen, Feuchtigkeit, unzureichende Belüftung oder korrosive Materialien vorhanden sind. Lesen Sie im Benutzerhandbuch über die Betriebsparameter.

Schließen Sie das Gerät an eine vorschriftsmäßig geerdete Steckdose an.

Die verwendeten Kühlmittel sind schwerer als Luft und werden im Fall einer Leckage den Sauerstoff ersetzen, was zu Bewusstlosigkeit führt. Kontakt mit auslaufendem Kühlmittel führt zu Hautverbrennungen.

Den Typ des verwendeten Kühlmittels entnehmen Sie dem Namensschild des Zirkulators und zusätzliche Informationen dem neuesten US Sicherheitsdatenblatt (SDS) des Herstellers, vormals MSDS, und dem EU Sicherheitsdatenblatt.

Transportieren Sie das Gerät mit Sorgfalt. Plötzliche Stöße oder das Herabfallen können seine Komponenten beschädigen. Schalten Sie vor dem Verschieben das Gerät immer ab und trennen Sie es von der Versorgungsspannung.

Betreiben Sie niemals beschädigte oder undichte Geräte.

Verwenden Sie niemals entzündbare oder korrosive Flüssigkeiten. Benutzen Sie nur zugelassene Flüssigkeiten, die in diesem Handbuch aufgelistet sind. Entnehmen Sie vor der Verwendung einer zugelassenen Flüssigkeit oder vor Wartungsarbeiten, bei denen der Kontakt mit der Flüssigkeit wahrscheinlich ist, zusätzliche Informationen dem neuesten US Sicherheitsdatenblatt (SDS) oder dem EU Sicherheitsdatenblatt.

Schalten Sie vor dem Verschieben das Gerät immer ab und trennen Sie es von der Versorgungsspannung. Lassen Sie die Instandhaltung und Reparaturen von einem qualifizierten Techniker durchführen.

Lagern Sie das Gerät bei Temperaturen von -25°C bis 60°C (mit Packung), und bei einer relativen Feuchtigkeit < 80%.

Die Außerbetriebnahme darf nur von einem Fachhändler unter Verwendung zertifizierter Ausrüstung durchgeführt werden. Alle einschlägigen Vorschriften müssen befolgt werden.

Die Ausführung von Installations-, Betriebs- oder Wartungsprozeduren, außer den im Handbuch beschriebenen, kann zu einer gefährlichen Situation führen und macht die Herstellergarantie ungültig.

Lassen Sie vor dem Start die Kühler in aufrechter Position bei Raumtemperatur (~25°C) 24 Stunden lang stehen. Dies stellt sicher, dass das Schmieröl wieder in den Kompressor zurückfließt.

Polar Kühler sind nicht für die Montage auf Boden konstruiert.

Legen Sie niemals Netzspannung an einen der Kommunikationsanschlüsse am Kühler an.

Kein Frostschutzmittel für Autos verwenden. Handelsübliche Frostschutzmittel enthalten Silikate, welche die Pumpendichtungen beschädigen.

Prüfen Sie beim Gebrauch einer Prozessflüssigkeitsmischung aus EG/Wasser oder PG/Wasser, regelmäßig die Konzentration und den pH-Wert der Flüssigkeit. Änderungen der Konzentration und des pH-Wertes können die Leistung des Systems beeinträchtigen. Verwenden Sie keine EntionisierungsfILTERPATRONE (DI) mit inhibiertem EG oder inhibiertem PG. Ein DI-Filter entfernt die Inhibitoren aus der Lösung, wodurch die Flüssigkeit wirklos gegen Korrosionsschutz wird. Inhibitoren können auch die Leitfähigkeit der Flüssigkeit erhöhen.

Die Software des Polar Kühlers muss auf die verwendete Prozessflüssigkeit eingestellt werden.

Biozide sind korrosiv und können irreversible Augenschäden und Hautverbrennungen verursachen. Sie sind schädlich wenn man sie einatmet, schluckt oder durch die Haut absorbiert. Lesen Sie das neueste SDS des Herstellers.

Wird der Kondensatorfilter nicht gereinigt/ersetzt, führt das zu einem Verlust der Kühlleistung und zu einem vorzeitigen Kühlsystemausfall.

Darf der Kühler keinesfalls mit einer entfernten Seitenwand betrieben werden.

Verwendungszweck, Umwälzungskühler:

Umwälzungskühler von Thermo Scientific sind so konstruiert, dass sie einen kontinuierlichen Zulauf der Flüssigkeit bei konstanter Temperatur und Durchflussrate ermöglicht. Der Kühler besteht aus einem luft- und wassergekühlten Kühlsystem, Wärmetauscher, Umwälzpumpe, Prozessflüssigkeitsbehälter und einem Mikroprozessor-Steuergerät.

Die Kühler sind für den Dauerbetrieb und den Innengebrauch unter Einhaltung aller in diesem Handbuch angegebenen Prozeduren und Anforderungen konstruiert.

Installation, Umwälzungskühler:

Platzieren Sie den Kühler so, dass er in der Nähe seiner Trennvorrichtung ist, und leichten Zugang zu diesem hat.

Der Kühler ist für den Gebrauch an einer speziellen Steckdose vorgesehen.

Stellen Sie sicher, dass alle Rohrleitungstransportstecker vor der Installation entfernt werden.

Um bei Polar Kühlern Schäden an der Verrohrung des Kühlers zu vermeiden, verwenden Sie ein 19 mm Stützschlüssel, wenn Sie externe Anschlüsse entfernen/einbauen.

Die Anschlüsse für Prozessflüssigkeit befinden sich auf der Rückseite des Kühlers und sind mit  (PROCESS OUTLET (PROZESSAUSLASS)) und  (PROCESS INLET (PROZESSEINLASS)) gekennzeichnet. Schließen Sie  an den Flüssigkeitseinlass Ihrer Anwendung an. Schließen Sie  an den Flüssigkeitsauslass Ihrer Anwendung an.

Bevor Sie den Kühler starten, führen Sie eine Doppelkontrolle aller Kommunikations-, elektrischen und Rohranschlüssen.

Consignes de sécurité Refrigidisseurs à recirculation

Si vous ne comprenez pas l'une de ces instructions, reportez-vous au manuel ou contactez-nous avant d'effectuer une opération.

Sécurité, tous les produits :

 indique une situation de danger imminent qui, si elle n'est pas évitée, peut entraîner une blessure grave ou mortelle.

 indique une situation de danger potentiel qui, si elle n'est pas évitée, pourrait entraîner une blessure grave ou mortelle.

 indique une situation de danger potentiel qui, si elle n'est pas évitée, peut entraîner une blessure légère à modérée. Ce symbole est également utilisé pour mettre en garde contre des pratiques dangereuses.

 ce symbole avertit l'utilisateur de la présence d'une « tension dangereuse » non isolée dans l'enceinte du réfrigérant. La magnitude de la tension est suffisante pour constituer un risque d'électrocution.

 indique la présence de surfaces chaudes.

 indique qu'il convient de lire le manuel.

N'utilisez pas l'équipement comme appareil stérile ou relié au patient. En outre, l'équipement n'est pas prévu pour une utilisation dans des emplacements dangereux de classe I, II ou III, tels que définis par le National Electrical Code.

Il est conçu pour l'usage intérieur exclusivement. Ne placez jamais l'équipement dans un endroit présentant un excès de chaleur, d'humidité, une ventilation inadaptée ou des matériaux corrosifs. Reportez-vous au manuel pour connaître les paramètres de fonctionnement.

Branchez l'équipement sur une prise correctement mise à la terre.

Les réfrigérants utilisés sont plus lourds que l'air. En cas de fuite, ils chassent l'oxygène et provoquent une perte de connaissance. Tout contact avec la fuite de réfrigérant peut causer des brûlures cutanées.

Reportez-vous à la plaque signalétique du circulateur pour connaître le type de réfrigérant utilisé. Lisez également la fiche de données de sécurité (SDS, anciennement MSDS) américaine la plus récente du fabricant ainsi que la fiche de données de sécurité européenne pour obtenir des informations complémentaires.

Déplacez l'équipement avec précaution. Les secousses ou les chutes peuvent endommager les composants. Éteignez l'équipement et débranchez la tension d'alimentation de sa source avant de le déplacer.

Ne faites jamais fonctionner un équipement endommagé ou qui fuit.

N'utilisez jamais des liquides inflammables ou corrosifs. Utilisez uniquement les liquides approuvés cités dans le manuel. Avant d'utiliser un liquide ou de procéder à une opération de maintenance pouvant comporter un contact avec le liquide, reportez-vous aux fiches de données de sécurité du fabricant et de l'Union européenne pour obtenir des informations complémentaires.

Éteignez l'équipement et débranchez-le de sa tension d'alimentation avant de le déplacer.

Confiez les entretiens et réparations à un technicien qualifié.

Stockez l'équipement à une température comprise entre 25°C et 60°C (avec l'emballage), et sous une humidité relative <80%.

La mise hors service doit être effectuée par un revendeur qualifié à l'aide d'un équipement certifié. Toutes les réglementations en vigueur doivent être respectées.

L'exécution des procédures d'installation, de fonctionnement ou de maintenance autres que celles décrites dans le manuel peut créer une situation dangereuse et annuler la garantie du fabricant.

Les réfrigérateurs Polar ne sont pas conçus pour être montés au sol. Conservez les réfrigérateurs en position verticale à température ambiante (~25°C) pendant 24 heures avant leur démarrage. Cette opération permet de rediriger l'huile de lubrification vers le compresseur.

Ne mettez jamais les raccords de communications du réfrigérant sous tension.

N'utilisez pas d'antigel automobile. Les antigels commerciaux contiennent des silicates qui endommagent les joints de la pompe.

Si vous utilisez un mélange d'éthylène glycol et d'eau ou de propylène glycol et d'eau, vérifiez régulièrement sa concentration et son pH. Les changements de concentration et de pH peuvent avoir une influence sur les performances du système.

N'utilisez pas de cartouche à filtre de désionisation (DI) avec de l'éthylène glycol inhibé ou du propylène glycol inhibé. Un filtre DI éliminera les inhibiteurs de la solution et rendra le liquide inefficace contre la protection anti-corrosion. De même, les inhibiteurs augmentent la conductivité du liquide.

Le logiciel du réfrigérant Polar doit être réglé afin de correspondre au liquide utilisé.

Les biocides sont corrosifs et peuvent causer des lésions oculaires irréversibles ainsi que des brûlures cutanées. Ils sont nocifs s'ils sont inhalés, avalés ou absorbés par la peau. Reportez-vous à la fiche de données de sécurité la plus récente du fabricant.

Le non-nettoyage ou non-remplacement du filtre du condenseur peut causer une perte de capacité de refroidissement et entraîner une panne prématurée du système de refroidissement.

Le boîtier du condenseur et les ailettes situés derrière la grille avant sont très tranchants.

Ne faites jamais fonctionner le réfrigérant si l'un des panneaux est déposé.

Utilisation prévue des refroidisseurs à recirculation :

Les refroidisseurs à recirculation de Thermo Scientific sont conçus pour fournir du liquide en continu à une température et selon un débit constants. Le refroidisseur se compose d'un système de réfrigération à air ou à eau, d'un échangeur de chaleur, d'une pompe de recirculation, d'un réservoir de liquide et d'un contrôleur à microprocesseur.

Les refroidisseurs sont conçus pour fonctionner en continu à l'intérieur, conformément à toutes les procédures et exigences indiquées dans son manuel.

Installation des refroidisseurs à recirculation :

Placez le refroidisseur de manière à ce qu'il soit à proximité et d'accès facile à son dispositif de sectionnement.

Le refroidisseur doit être branché sur une prise dédiée.

Vérifiez que tous les bouchons d'expédition de la tuyauterie sont retirés avant l'installation.

Pour éviter d'endommager la plomberie du refroidisseur Polar, utilisez une clé de 19 mm lors de la dépose ou de l'installation des raccordements externes.

Les raccordements du liquide de traitement se situent à l'arrière du refroidisseur et portent les étiquettes  (PROCESS OUTLET, SORTIE LIQUIDE) et  (PROCESS INLET, ENTREE LIQUIDE).

Reliez  sur l'entrée du liquide de votre application. Reliez  sur la sortie du liquide de votre application.

Avant de démarrer le refroidisseur, vérifiez deux fois tous les raccordements électrique, de plomberie et de communication.

ES

Instrucciones básicas de seguridad Refrigeradores de recirculación

Si no se entiende alguna de estas instrucciones, consulte el manual o póngase en contacto con nosotros antes de proceder.

Seguridad, todos los productos:

 indica una situación de peligro inmediato que, si no se evita, provocará la muerte o lesiones graves.

 indica una situación potencialmente peligrosa que, si no se evita, podría tener como resultado lesiones graves o la muerte.

 indica una situación potencialmente peligrosa que, si no se evita, puede ocasionar lesiones leves o moderadas. También se utiliza para alertar de prácticas inseguras.

 está indicado para alertar al usuario de la presencia de "tensión peligrosa" sin aislar dentro del alojamiento del refrigerador. La magnitud de la tensión es lo suficientemente importante para constituir un riesgo de electrocución.

 indica la presencia de superficies calientes.

 indica que se debe leer el manual.

No utilice el equipo como dispositivo conectado al paciente o dispositivo estéril. Además, el equipo no está diseñado para ser utilizado en lugares peligrosos de Clase I, II o III de acuerdo con el Código Eléctrico Nacional.

Este equipo está diseñado para ser utilizado en interiores solamente. No lo coloque nunca en un lugar donde haya calor excesivo, humedad, ventilación inadecuada o materiales corrosivos. Consulte el manual para conocer los parámetros de funcionamiento.

Conecte el equipo a una toma correctamente conectada a tierra.

Los refrigerante utilizados son más pesados que el aire y, si hay una fuga, sustituirán al oxígeno, lo que provocará la pérdida de consciencia. El contacto con el refrigerante expulsado provocará quemaduras en la piel. Consulte la placa de datos del circulador para conocer el tipo de refrigerante utilizado y, a continuación, la hoja de datos de seguridad (SDS) más reciente del fabricante para EE.UU., anteriormente conocida como MSDS, así como la hoja de datos de seguridad para la UE a fin de obtener información adicional.

Mueva el equipo con cuidado. Las caídas o los impactos repentinos pueden dañar los componentes. Apague siempre el equipo y desconéctelo de la tensión de suministro antes de moverlo.

Nunca utilice un equipo dañado o con fugas.

Nunca utilice fluidos inflamables o corrosivos. Utilice solo los fluidos aprobados que se incluyen en el manual. Antes de utilizar un fluido o realizar tareas de mantenimiento donde es probable que se entre en contacto con el fluido en cuestión, consulte la hoja de datos de seguridad (SDS) más reciente del fabricante para EE.UU., así como la hoja de datos de seguridad para la UE a fin de obtener información adicional.

Apague siempre el equipo y desconéctelo de la tensión de suministro antes de moverlo.

Delegue las tareas de servicio y las reparaciones en un técnico cualificado.

Guarde el equipo a una temperatura comprendida entre -25 °C y 60 °C (con embalaje), y una humedad relativa de <80%.

El desmantelamiento solo debe ser realizado por un proveedor cualificado que utilice el equipo homologado. Debe cumplirse toda la normativa vigente.

La realización de los procedimientos de instalación, funcionamiento o mantenimiento distintos de los que se describen en el manual puede dar lugar a situaciones peligrosas y anularán la garantía del fabricante.

Deje los refrigeradores en posición vertical a temperatura ambiente (~25 °C) durante 24 horas antes de comenzar. De este modo se asegurará de que el aceite de lubricación haya pasado al compresor.

Los refrigeradores Polar no están diseñados para ser montados sobre el suelo.

Nunca aplique tensión de línea a ninguna de las conexiones de comunicación del refrigerador.

No utilice anticongelante de automoción. Los anticongelantes comerciales contienen silicatos que dañan las juntas de las bombas.

Para evitar la congelación/el viriado del intercambiador de la placa, los refrigeradores.

Al utilizar una mezcla de fluido para procesos de EG/agua o PG/agua, revise la concentración y el pH del fluido periódicamente. Los cambios en la concentración y el pH pueden alterar el rendimiento del sistema.

No utilice un cartucho de filtro de desionización (DI) con EG o PG inhibido. Un filtro DI eliminará los inhibidores de la solución y hará que el fluido sea ineficaz contra la protección anticorrosión. Además, los inhibidores aumentan la conductividad de los fluidos.

El software del refrigerador Polar debe ajustarse de acuerdo con el fluido para procesos utilizado.

Los biocidas son corrosivos y pueden provocar daños irreversibles en los ojos y quemaduras en la piel. Son dañinos si se inhalan, se tragan o se absorben a través de la piel. Consulte la hoja SDS más reciente del fabricante.

Si no se limpia/sustituye el filtro del condensador, se producirá una pérdida de capacidad de enfriamiento y esto supondrá un fallo prematuro del sistema de enfriamiento.

Nunca utilice el refrigerador con los paneles retirados.

Uso previsto, Refrigeradores de recirculación:

Los refrigeradores de recirculación de Thermo Scientific están diseñados para ofrecer un suministro continuo de fluido a una temperatura y una tasa de caudal constantes. Los refrigeradores constan de un sistema de refrigeración enfriado por aire o por agua, un intercambiador de calor, una bomba de recirculación, un depósito de fluido para procesos y un controlador de microprocesador.

Los refrigeradores están diseñados para llevar a cabo un funcionamiento continuo y para utilizarse en interiores de acuerdo con todos los procedimientos y requisitos que se detallan en su manual.





Instalación, Refrigeradores de recirculación:

Ubique el refrigerador cerca de su dispositivo de desconexión y de forma que resulte fácil acceder a él.

El refrigerador está diseñado para ser utilizado en una toma especial.

Asegúrese de retirar todos los tapones de envío de la línea de tuberías antes de la instalación.

En el caso de los refrigeradores Polar, para evitar daños en las tuberías del refrigerador, utilice una llave inglesa fija de 19 mm al retirar/instalar las conexiones externas.

Las conexiones de fluido para procesos se encuentran en la parte posterior del refrigerador y están marcadas con el texto  (PROCESS OUTLET, SALIDA PARA PROCESOS) y  (PROCESS INLET, ENTRADA PARA PROCESOS). Conecte  a la entrada de fluido de su aplicación. Conecte  a la salida de fluido de su aplicación.

Antes de poner en marcha el refrigerador, vuelva a comprobar todas las conexiones de comunicación, eléctricas y de tuberías aplicables.

Instruções de Segurança Essenciais Refrigeradores de Recirculação

No caso de não compreender qualquer uma destas instruções, consulte o manual ou contacte-nos antes de prosseguir.

Segurança, todos os produtos:

 Indica uma situação de perigo iminente que, se não for evitada, vai resultar em morte ou lesões graves.

 Indica uma situação de potencial perigo, que se não for evitada, pode resultar em morte ou lesões graves.

 Indica uma situação de potencial perigo, que se não for evitada, pode resultar em ferimentos leves ou moderados. Também é utilizado para alertar contra práticas não seguras.

 Destina-se a alertar o utilizador para a presença de "voltagem perigosa" sem isolamento na caixa do refrigerador. A magnitude da voltagem é suficientemente significativa para constituir um risco de choque eléctrico.

 Indica a presença de superfícies quentes.

 Indica a leitura do manual.

Não utilize o equipamento como um dispositivo estéril ou ligado ao paciente. Em complemento, o equipamento não se destina a ser utilizado em Locais Perigosos de Classe I, II ou III conforme definido pelo Código Eléctrico Nacional.

O equipamento destina-se apenas a utilização interior. Nunca o coloque num local onde exista calor em excesso, humidade, ventilação não adequada, ou materiais corrosivos. Consulte o manual relativamente a parâmetros operacionais.

Ligue o equipamento a uma tomada de alimentação com ligação à terra.

Os refrigerantes utilizados são mais pesados do que o ar e, em caso de fuga, vão substituir o oxigénio causando perda de consciência. O contacto com o refrigerante em vazamento vai causar queimaduras na pele. Consulte a placa de identificação do circulador relativamente ao tipo de refrigerante utilizado e depois a Ficha de Segurança (SDS) dos EUA mais recente, anteriormente designada como MSDS, e a Ficha de Segurança da UE para informação adicional.

Movimente o equipamento com cuidado. Solavancos ou quedas súbitas podem danificar os seus componentes. Desactive sempre o equipamento e desligue-o da sua tensão de alimentação antes de o deslocar.

Nunca coloque em funcionamento equipamento danificado ou em vazamento.

Nunca utilize fluidos inflamáveis ou corrosivos. Utilize apenas os fluidos aprovados listados no manual. Antes de utilizar qualquer fluido ou efectuar manutenção onde for provável o contacto com o fluido, consulte a Ficha de Segurança (SDS) dos EUA mais actualizada e a Ficha de Segurança da UE para informação adicional.

Desactive sempre o equipamento e desligue-o da sua fonte de alimentação antes de o deslocar.

As revisões e reparações devem ser efectuadas por um técnico qualificado.

Armazene o equipamento a um intervalo de temperatura entre -25°C a 60°C (com embalagem), e <80% de humidade relativa.

O desmantelamento deve ser apenas efectuado por um representante qualificado utilizando equipamento certificado. Todos os regulamentos predominantes têm de ser seguidos.

Realizar procedimentos de instalação, operação ou manutenção para além dos descritos no manual pode resultar numa situação perigosa e pode invalidar a garantia do fabricante.

Os refrigeradores polares não se destinam a ser montados no solo. Deixe os refrigeradores na posição vertical à temperatura ambiente (~25°C) durante 24 horas antes do arranque. Desta forma assegura que o óleo de lubrificação foi drenado para o compressor.

Nunca aplique tensão de linha a qualquer uma das ligações de comunicação no refrigerador.

Não utilize anticongelante automóvel. O anticongelante comercial contém silicatos que danificam os vedantes da bomba.

Quando utilizar uma mistura de fluido de processamento de EG/água ou PG/água, verifique a concentração do fluido e o pH regularmente. Alterações na concentração e no pH podem ter impacto no desempenho do sistema.

Não utilize um cartucho de filtro de Desionização (DI) com EG Inibido ou PG Inibido. Um filtro de DI vai remover os inibidores da solução que estão a tornar o fluido ineficaz contra a protecção de corrosão. Para além disso, os inibidores aumentam a condutividade do fluido.

O software dos refrigeradores polares tem de ser ajustado de acordo com o fluido de processo utilizado.

Os biocidas são corrosivos e podem causar lesões oculares irreversíveis e queimaduras na pele. São prejudiciais se inalados, engolidos ou absorvidos através da pele. Consulte a Ficha de Segurança do fabricante mais actualizada.

A não limpeza/substituição do filtro do condensador causa a perda da capacidade de arrefecimento e conduz a uma falha prematura do sistema de arrefecimento.

Nos refrigeradores refrigerados a ar, a moldura e rebordos do condensador localizados por detrás do conjunto da grelha frontal são muito aguçados.

Nunca opere o refrigerador com qualquer painel removido.

Utilização Prevista, Refrigeradores de Recirculação:

Os refrigeradores de recirculação Thermo Scientific são concebidos para facultar um fornecimento contínuo de fluido a um fluxo e temperatura constantes. O refrigerador conste num sistema de refrigeração com arrefecimento a ar ou água, permutador de calor, bomba de recirculação, reservatório de fluido de processamento e um controlador de microprocessador.

Os refrigeradores destinam-se a funcionamento contínuo e para utilização interna de acordo com todos os procedimentos e requisitos descritos deste manual.

Instalação, Refrigeradores de Recirculação:

Coloque o refrigerador de forma a que esteja próximo e tenha fácil acesso ao dispositivo de desconexão.

O refrigerador destina-se a utilização numa tomada dedicada.

Certifique-se de que todas as fichas de expedição da linha de canalização são removidas antes da instalação.

No caso dos refrigeradores Polar, para evitar danos na tubagem do refrigerador, utilize uma chave de apoio de 19 mm quando remover/instalar as ligações externas.

As ligações de fluido de processamento encontram-se localizadas na parte posterior do refrigerador e encontram-se etiquetadas  ((PROCESS INLET) (ENTRADA DE PROCESSAMENTO)) e  ((PROCESS OUTLET) (SAÍDA DE PROCESSAMENTO)) e  à entrada de fluido na sua aplicação. Ligue a  à saída de fluido na sua aplicação.

Antes de iniciar o refrigerador, verifique todas as ligações de comunicação, eléctricas e tubagens aplicáveis.

Essentiële veiligheidsinstructies Recirculatiekoelers

Als één van de instructies niet duidelijk is, raadpleeg dan de handleiding of neem contact op met ons vooraleer door te gaan.

Veiligheid, alle producten:

 duidt op een onmiddellijke gevaarlijke situatie die, indien ze niet wordt vermeden, zal leiden tot de dood of ernstige letsels.

 duidt op een gevaarlijke situatie die, indien ze niet wordt vermeden, kan leiden tot de dood of ernstige letsels.

 duidt op een mogelijke gevaarlijke situatie die, indien ze niet wordt vermeden, zal leiden tot lichte of middelmatige letsels. Het kan ook gebruikt worden als waarschuwing tegen onveilige praktijken.

 bedoeld om de gebruiker te waarschuwen voor de aanwezigheid van een niet-geïsoleerde "gevaarlijke spanning" binnenin de behuizing van de koeler. De grootte van de spanning is voldoende significant om een gevaar te vormen op een elektrisch schok.

 duidt op de aanwezigheid van hete oppervlakken.

 duidt op het raadplegen van de handleiding.

Gebruik de apparatuur niet als steriel of als een met de patiënt verbonden apparaat. Daarnaast is de apparatuur niet ontworpen voor gebruik in gevaarlijke locaties van klasse I, II of III zoals gedefinieerd door de National Electrical Code.

De apparatuur is uitsluitend bedoeld voor gebruik binnenshuis. Plaats deze nooit op een locatie met overmatige hitte, vochtigheid, onvoldoende ventilatie of waar er corrosieve materialen aanwezig zijn. Raadpleeg de handleiding voor de operationele parameters.

Sluit de apparatuur steeds aan op een goed geaard stopcontact.

Koelmiddelen zijn zwaarder dan lucht en als er een lek is, zal het de zuurstof vervangen en kan dit leiden tot bewusteloosheid. Contact met het lekkende koelmiddel kan leiden tot brandwonden op de huid.

Raadpleeg het typeplaatje van de circulatiepomp voor het type koelmiddel dat wordt gebruikt en raadpleeg vervolgens het meest recente veiligheidsgegevensblad (Safety Data Sheet - SDS) van de producent, eerder gekend als MSDS, en het Europese veiligheidsgegevensblad voor extra informatie.

Verplaats de apparatuur steeds erg zorgvuldig. Plotsse schokken of druppels kunnen de componenten beschadigen. Schakel de apparatuur steeds uit en haal de stekker uit het stopcontact vooraleer deze te verplaatsen.

Gebruik nooit beschadigde of lekkende apparatuur.

Gebruik nooit ontvlambare of corrosieve vloeistoffen. Maak alleen gebruik van de goedgekeurde vloeistoffen in de handleiding. Raadpleeg, vooraleer een vloeistof te gebruiken of onderhouden uit te voeren waarbij het waarschijnlijk is dat u in aanraking komt met de vloeistof, het meest recente veiligheidsgegevensblad (Safety Data Sheet - SDS) van de producent en het Europese veiligheidsgegevensblad voor extra informatie.

Schakel de apparatuur steeds uit en haal de stekker uit het stopcontact vooraleer deze te verplaatsen.

Laat het onderhoud en de herstellingen steeds uitvoeren door een gekwalificeerd technicus.

Sla de apparatuur op bij een temperatuur tussen -25°C tot 60°C (met verpakking) en een relatieve vochtigheid van minder dan 80%.

Het buiten dienst stellen mag alleen uitgevoerd worden door een gekwalificeerde dealer die gebruik maakt van gecertificeerde uitrusting. Alle geldende regelgevingen moeten worden gevolgd.

Het uitvoeren van de installatie-, de werkings- of onderhoudsprocedures op een andere manier dan beschreven in de handleiding kan leiden tot een gevaarlijke situatie en zal de garantie van de producent ongeldig maken.

Polar-koelers zijn niet ontworpen om op de vloer te worden gemonteerd. Laat de koelers gedurende 24 uur in een rechtopstaande positie bij kamertemperatuur (~25°C) staan vooraleer deze te starten. Dit verzekert dat de smeerolie terug in de compressor is gelopen.

Sluit nooit de netspanning aan op de communicatie-aansluitingen van de koeler.

Gebruik geen antivriesmiddel voor auto's. Commercieel antivriesmiddel bevat silicaten die de pompdichtingen kunnen beschadigen.

Bij gebruik van een mix van procesvloeistoffen van EG/water of PG/water dient u de vloeistofconcentratie en pH op een regelmatige basis te controleren. Wijzigingen in de concentratie en de pH kunnen een impact hebben op de prestaties van het systeem. Gebruik geen deïonisatie(DI)-filtercartridge met Inhibited EG of Inhibited PG.

Een DI-filter zal remmers uit de vloeistof verwijderen waardoor de vloeistof niet meer effectief is als bescherming tegen corrosie. Daarnaast verhogen remmers de geleiding van vloeistoffen.

De software van de Polar-koeler moet aangepast worden zodat deze overeenkomt met de gebruikte procesvloeistof.

Biociden zijn corrosief en kunnen onherstelbare schade toebrengen aan de ogen en ook brandwonden veroorzaken. Ze zijn schadelijk als ze worden geïnhaled, worden ingeslikt of worden opgenomen via de huid. Raadpleeg het meest recente veiligheidsgegevensblad (SDS) van de producent.

Het malaten om de filter van de condensor te reinigen of te vervangen kan leiden tot een verlies van koelcapaciteit en tot het voortijdig defect raken van het koelsysteem.

Bij luchtgekoelde koelers bevinden het kader en de vinnen van de condensor zich achter de voorste rooster en dient u goed op te letten want ze zijn erg scherp.

Bij andere koelers dan degene met een luchtgekoeld rooster mag u de koeler nooit activeren wanneer het paneel verwijderd is.

Bedoeld gebruik, recirculatiekoelers:

De recirculatiekoelers van Thermo Scientific zijn ontworpen om een continue toevoer van vloeistoffen te voorzien met een constante temperatuur en doorstroming. De koeler bestaat uit een luchtgekoeld of watergekoeld koelsysteem, warmtewisselaar, recirculatiepomp, reservoir voor proces/vloeistof en een microprocessorcontroller.

Koelers zijn ontworpen voor een continue werking en voor gebruik binnenshuis in overeenkomst met alle procedures en vereisten die staan vermeld in de handleiding.





Installatie, recirculatiekoelers:

Plaats de koeler zodat deze zich dichtbij het loskoppelapparaat bevindt en dat deze eenvoudig toegankelijk is.

De koeler is bedoeld voor gebruik op een daartoe bestemde uitvoer.

Verzekert dat alle transportpluggen op de leidingen zijn verwijderd voor de installatie.

Om schade te voorkomen aan de leidingen van de koeler van Polar-koelers gebruikt u een moersleutel van 19 mm bij het losmaken/installeren van de externe aansluitingen.

De aansluitingen van de procesvloeistof bevinden zich op de achterzijde van de koeler en hebben een label  (PROCESS OUTLET (PROCESUITVOER)) en  (PROCESS INLET (PROCESTOEVOER)). Sluit de  aan op de vloeistoftoevoer van uw applicatie. Sluit de  aan op de vloeistofuitvoer van uw applicatie.

Vooraleer de koeler te starten dient u alle van toepassing zijnde communicatie-aansluitingen, elektrische aansluitingen en leidingaansluitingen tweemaal te controleren.

Istruzioni essenziali per la sicurezza Chiller a ricircolazione

Se queste istruzioni non sono chiare, fare riferimento al manuale oppure contattare il nostro ufficio prima di procedere.

Sicurezza, tutti i prodotti:

 indica una situazione di pericolo imminente che, se non evitata, potrebbe causare morte o ferite gravi.

 indica una situazione potenzialmente pericolosa che se non evitata potrebbe causare lesioni gravi o morte.

 indica una situazione di pericolo potenziale che, se non evitata, potrebbe causare ferite lievi o non gravi. Viene anche utilizzato come avviso contro pratiche non sicure.

 destinato ad avvisare l'utente della presenza di "tensioni pericolose" non isolate all'interno dell'involucro del chiller. Il valore della tensione è abbastanza significativo da costituire un rischio di scosse elettriche.

 indica la presenza di superfici calde.

 segnala di leggere il manuale.

Non utilizzare l'apparecchiatura come dispositivo sterile o collegato a un paziente. Inoltre, l'apparecchiatura non è progettata per l'utilizzo in luoghi pericolosi di Classe I, II o III secondo le definizioni del National Electrical Code.

Questa apparecchiatura è destinata all'uso in ambienti chiusi. Non collocarla mai in luoghi soggetti a calore eccessivo, umidità, ventilazione inadeguata o materiali corrosivi. Fare riferimento al manuale per i parametri operativi.

Collegare l'apparecchiatura ad una presa di rete adeguatamente messa a terra.

I refrigeranti utilizzati sono più pesanti dell'aria e, in caso di perdite, possono sostituire l'ossigeno causando perdita di conoscenza. Il contatto della pelle con il refrigerante fuoriuscito causa ustioni. Per ulteriori informazioni, fare riferimento alla targhetta del circuito circolatore per il tipo di refrigerante utilizzato e ai dati tecnici di sicurezza aggiornati del produttore (US Safety Data Sheet - SDS), precedentemente noti come MSDS, non che ai dati tecnici di sicurezza UE.

Spostare l'apparecchiatura con cautela. Sobbalzi o cadute improvvisi possono danneggiare i suoi componenti. Spegnerne sempre l'apparecchiatura e scollegarla dalla tensione di alimentazione prima di spostarla.

Non utilizzare mai apparecchiature danneggiate o con perdite.

Non utilizzare mai fluidi infiammabili o corrosivi. Utilizzare esclusivamente i fluidi certificati elencati nel manuale. Prima di utilizzare fluidi o eseguire operazioni di manutenzione che prevedano il contatto con il fluido, fare riferimento ai dati tecnici di sicurezza aggiornati del produttore (US Safety Data Sheet - SDS) e ai dati tecnici di sicurezza UE per ulteriori informazioni.

Spegnerne sempre l'apparecchiatura e scollegarla dalla tensione di alimentazione prima di spostarla.

Demandare assistenza e riparazioni ad un tecnico qualificato.

Conservare l'apparecchiatura ad una temperatura compresa tra -25°C e 60°C (con imballo), e una umidità relativa <80%.

La disattivazione deve essere eseguita solo da rivenditori qualificati utilizzando attrezzature certificate.

Dovranno essere rispettate tutte le norme vigenti.

L'esecuzione di procedure di installazione, funzionamento o manutenzione diverse da quelle descritte nel manuale potrebbero determinare situazioni di pericolo e causare l'annullamento della garanzia del produttore.

I chiller polari non sono progettati per il montaggio a pavimento. Lasciare i dispositivi di raffreddamento in posizione verticale a temperatura ambiente (-25°C) per 24 prima dell'avviamento. Ciò garantirà il ritorno dell'olio di lubrificazione nel compressore.

Non applicare mai la tensione di linea alle connessioni di comunicazione presenti sul chiller.

Non utilizzare antigelo per autotrazione. L'antigelo commerciale contiene silicati che danneggiano le guarnizioni della pompa.

Quando si utilizza una miscela di fluido di EG/acqua o PG/acqua, verificare periodicamente la concentrazione del fluido e il pH. Eventuali variazioni di concentrazione e pH possono compromettere le prestazioni del sistema.

Non utilizzare un cartuccia filtro di deionizzazione (DI) con EG o PG inibiti. Un filtro DI rimuoverà gli inibitori dalla soluzione, rendendo il fluido inefficace contro la corrosione. Inoltre, gli inibitori fanno aumentare la conducibilità del fluido.

Il software dei chiller Polar deve essere impostato per adeguarsi al fluido di processo utilizzato.

I biocidi sono corrosivi e possono causare danni irreversibili agli occhi e ustioni cutanee. Sono pericolosi se inalati, ingeriti o assorbiti attraverso la pelle. Fare riferimento ai documenti SDS più aggiornati del produttore.

La mancata pulizia/sostituzione del filtro del condensatore provoca una perdita della capacità di raffreddamento con il rischio di guasti prematuri del sistema di raffreddamento. Nei chiller raffreddati ad aria le alette ed il telaio del condensatore dietro il gruppo della griglia anteriore sono molto affilati.

Non azionare mai il chiller con pannelli rimossi.

Destinazione d'uso, chiller a ricircolazione:

I chiller a ricircolazione Thermo Scientific sono progettati per fornire un'alimentazione continua di fluido a temperatura e portata costanti. Il chiller è composto da un sistema di refrigerazione raffreddato ad aria o ad acqua, uno scambiatore di calore, una pompa di ricircolazione, un serbatoio del fluido di processo e un controller a microprocessore.

I chiller sono progettati per il funzionamento continuo e per l'utilizzo in ambienti chiusi, in conformità con tutte le procedure e i requisiti definiti in questo manuale.

Installazione, chiller a ricircolazione:

Posizionare il chiller in modo che sia vicino ed abbia un pratico accesso al suo dispositivo di disconnessione.

Il chiller deve essere utilizzato su una presa dedicata.

Assicurarsi che tutte le spine utilizzate per la spedizione nelle linee di tubazione siano state rimosse prima di procedere all'installazione.

Nei chiller Polar, per evitare danni alle tubazioni del chiller, utilizzare una chiave da 19 mm quando si rimuovono/installano le connessioni esterne.

Le connessioni per il fluido di processo si trovano sul retro del chiller e sono etichettati  (PROCESS INLET) e  (PROCESS OUTLET) all'uscita del fluido sull'applicazione. Collegare  all'ingresso del fluido sull'applicazione. Collegare  all'uscita del fluido sull'applicazione.

Prima di avviare il chiller, ricontrrollare tutte le linee di comunicazione e le connessioni elettriche e delle tubazioni.





Важни инструкции за безопасност Рециркуляционни охладители

Ако някоя от тези инструкции не бъде разбрана, се обърнете към ръководството или се свържете с нас, преди да продължите.

Безопасност, всички продукти:

 **DANGER** **указва** непосредствено опасна ситуация, която, ако не бъде избегната, ще доведе до смърт или тежка телесна повреда.

 **WARNING** **указва** потенциално опасна ситуация, която, ако не бъде избегната, може да доведе до смърт или тежка телесна повреда.

 **CAUTION** **указва** потенциално опасна ситуация, която, ако не бъде избегната, може да доведе до лека или средна телесна повреда. Също така се използва, за да предупредява срещу опасни практики.

 **предназначен** да предупредява потребителя за наличие на неизолирано "опасно напрежение" в рамките на корпуса на охладителя. Величината на напрежението е достатъчно значима, за да поражда риск от електрически удар.

 **указва** наличието на горещи повърхности.

 **указва**, че ръководството трябва да се прочете.

Не използвайте оборудването като стерилно устройство или устройство, свързано с пациенти. В допълнение устройството не е предназначено за употреба в клас I, II или III опасни места, както е определено от Националния закон за електричеството на САЩ (NEC).

Оборудването е предназначено само за употреба в закрити помещения. Никога не го поставяйте на място, където са налице прекомерна топлина, влага, лоша вентилация или корозивни материали. Вижте ръководството за експлоатационните параметри.

Свържете оборудването към правилно заземен контакт.

Използваните хладилни агенти са по-тежки от въздуха и, ако има теч, те ще заменят кислорода, причинявайки загуба на съзнание. Контактът с изтичащ хладилен агент ще предизвика изгаряния на кожата. Направете справка с фирмената табела на циркулатора за типа на използвания хладилен агент, след което към най-актуалния информационен лист за безопасност на САЩ (SDS) от производителя, известен преди като MSDS, и също така и към информационния лист за безопасност на ЕС, за допълнителна информация.

Премествайте оборудването внимателно. Внезапни сътресения или излускания могат да повредят компонентите му. Винаги изключвайте устройството и го разкачайте от неговото захранващо напрежение, преди да го преместите.

Никога не експлоатирайте повредено оборудване или оборудване с течове.

Никога не използвайте запалими или корозивни течности. Използвайте само одобрените течности, посочени в ръководството. Преди да се използва каквато и да било течност или да се прави поддръжка, където е вероятно да има контакт с течността, направете справка с най-актуалния информационен лист за безопасност на САЩ (SDS) от производителя, както и информационния лист за безопасност на ЕС, за допълнителна информация.

Винаги изключвайте устройството и го разкачайте от неговото захранващо напрежение преди преместване.

За обслужване и ремонтни дейности се обърнете към квалифициран техник.

Съхранявайте оборудването при температура от -25°C до 60°C (с опаковката) и $<80\%$ относителна влажност.

Извеждането от експлоатация трябва да се извършва само от квалифициран дилър, като се използва сертифицирано оборудване. Всички действащи разпоредби трябва да се спазват.

Извършване на монтаж, експлоатация или процедури за поддръжка, различни от тези, описани в ръководството, може да доведе до опасна ситуация и ще анулира гаранцията на производителя.

Оставете охладителите в изправено положение при стайна температура ($\sim 25^{\circ}\text{C}$) в продължение на 24 часа, преди да ги стартирате. Това гарантира, че смазочното масло ще се оттеди обратно в компресора.

Охладителите Rolag не са предназначени да бъдат монтирани на пода.

Никога да не се прилага линейно напрежение към някоя от комуникационните връзки на охладителя.

Непълното запълване на охладителя и на технологичните тръбопроводи за течности може да повреди помпата на охладителя. Избягвайте препълването, защото течностите се разширяват при нагряване.

Не използвайте антифриз от автомобилната индустрия. Серийният антифриз съдържа силикати, които увреждат уплътненията на помпата.

Когато се използва смес от технологична течност от EG/вода или PG/вода, редовно проверявайте концентрацията на течността и pH. Промениите в концентрацията и pH могат да окажат влияние върху производителността на системата. Не използвайте дейонизиращ (DI) патронен филтър с инхибирана EG или инхибирана PG. DI филтърът ще премахне инхибиторите от разтвора, правейки течността неефективна при защита от корозия. Също така инхибиторите повишават проводимостта на течностите.

Софтуерът на охладителя Rolag трябва да се регулира, за да е в съответствие с използваната технологична течност.

Биоцидите са корозивни и могат да предизвикат необратими увреждания на очите и изгаряния на кожата. Те са вредни при вдишване, поглъщане или абсорбиране през кожата. Направете справка с най-актуалния SDS на производителя.

Непочиственото/неподмяната на кондензаторния филтър ще причини загуба на капацитета на охладене и ще доведе до преждевременна повреда на охлаждащата система.

При охладителите с въздушно охлаждане рамките и перките на кондензатора, разположени зад модула на предната решетка, са много остри.

Никога не експлоатирайте охладителя с който и да било друг отстранен панел.

Предназначена употреба, рециркуляционни охладители:

Рециркуляционните охладители на Therm Scientific са предназначени да осигуряват непрекъснато подаване на течност при постоянна температура и дебит. Охладителят се състои от хладилна система с въздушно охлаждане или водно охлаждане, топлообменник, рециркуляционна помпа, резервоар за технологична течност и микропроцесорен контролер.

Охладителите са предназначени за непрекъсваема експлоатация и за употреба на закрито в съответствие с всички процедури и изисквания, посочени в съответното ръководство.

Монтиране, рециркуляционни охладители:

Разположете охладителя, така че да е близо и да има лесен достъп до устройството му за изключване.

Охладителят е предназначен за употреба с отделен контакт.

Уверете се, че всички тапи за транспортиране на водопроводните тръби са отстранени преди монтажа.

За охладителите Polarg, за да се предотврати повреда на тръбопровода на охладителя, използвайте 19 мм поддържащ гаечен ключ, когато отстранявате/монтирате външните връзки.

Връзките на технологичната течност се намират на гърба на охладителя и са отбелязани с етикети  (ТЕХНОЛОГИЧЕН ИЗХОД) и  (ТЕХНОЛОГИЧЕН ВХОД). Свържете  към входа за течности на вашето приложение. Свържете  към изхода за течности на вашето приложение.

Преди да стартирате охладителя, проверете отново всички приложими комуникационни, електрически и водопроводни връзки.

Základní bezpečnostní pokyny Recirkulační chladiče

Pokud některým z těchto pokynů nebudete rozumět, nahlédněte před pokračováním do návodu k obsluze nebo nás kontaktujte.

Bezpečnost, všechny produkty:



Značí bezprostředně nebezpečnou situaci, která pokud nebude odstraněna, povede ke smrtelnému nebo závažnému úrazu.



Značí potenciálně nebezpečnou situaci, která pokud nebude odstraněna, může vést ke smrtelnému nebo závažnému úrazu.



Značí potenciálně nebezpečnou situaci, která pokud nebude odstraněna, může vést k méně až středně závažnému úrazu. Slouží také jako výstraha před nebezpečnými postupy.



Slouží k upozornění uživatele na přítomnost neizolovaného „nebezpečného napětí“ v krytu chladičoho zařízení. Napětí je dostatečně vysoké na to, aby představovalo riziko úrazu elektrickým proudem.



Značí přítomnost horkých povrchů.



Značí, že si má obsluha přečíst návod k obsluze.

Vybavení nepoužívejte jako sterilní zařízení nebo zařízení připojené k pacientovi. Zařízení navíc není určeno k používání v rizikových lokalitách třídy I, II nebo III podle národních elektrotechnických předpisů.

Zařízení je navrženo pouze pro používání ve vnitřních prostorech. Nikdy ho neumisťujte do míst, kde je nadměrné teplo, vlhkost, nedostatečná ventilace nebo kde se nachází korozivní materiály. Provozní parametry jsou uvedené v návodu k obsluze.

Připojte zařízení k řádně uzemněné zásuvce.

Použitá chladiva jsou těžší než vzduch a pokud dojde k jejich úniku, vytlačí veškerý vzduch a způsobí ztrátu vědomí. Kontakt s unikajícím chladivem způsobí popálení pokožky. Typ použitého chladiva zjistíte na štítku s technickými údaji cirkulačního termostatu a další informace jsou uvedeny v aktuálním bezpečnostním listu výrobce.

Při stěhování zařízení buďte opatrní. Náhlé nárazy nebo pády mohou poškodit jeho součásti. Před stěhováním zařízení vždy vypněte a odpojte ho od přívodu napájení.

Nikdy nepoužívejte poškozené nebo netěsné zařízení.

Nikdy nepoužívejte hořlavé nebo korozivní kapaliny. Používejte pouze schválené kapaliny uvedené v návodu k obsluze. Před použitím nějaké kapaliny nebo před prováděním údržby, kde je pravděpodobné, že přijdete s touto kapalinou do styku, si zjistěte další informace v aktuálním bezpečnostním listu výrobce.

Před stěhováním zařízení vždy vypněte a odpojte ho od přívodu napájení.

Servis a opravy přenechejte kvalifikovaným servisním technikům.

Skladujte zařízení při teplotách -25°C až 60°C (v obalu), a při relativní vlhkosti vzduchu nižší než 80 %.

Výřazení z provozu smí provádět pouze kvalifikovaný prodejce s pomocí certifikovaného vybavení. Musí být dodržena veškerá platná nařízení.

Provádění jiných postupů při instalaci, obsluze nebo údržbě, než které jsou popsány v návodu k obsluze, může vést k nebezpečným situacím a způsobí zneplatnění záruky výrobce.

Než začnete, nechte chladičí zařízení umístěné nastojato 24 hodin při pokojové teplotě (přbl. 25 °C). Tím zajistíte, že se lubrikační olej vypustí zpátky do kompresoru.

Chladičí zařízení Polar nejsou navržena pro montáž na podlahu.

Nikdy nepřivádějte elektrické napětí k žádným komunikačním konektorům chladičoho zařízení.

Nepoužívejte automobilový odmrazovač. Běžně prodávané odmrazovače obsahují silikáty, které poškodí těsnění čerpadla.

Při používání směsi etylenglykolu a vody nebo propylenglykolu a vody pravidelně kontrolujte koncentraci kapaliny a pH. Změny v koncentraci a pH mohou mít vliv na výkon systému. Nepoužívejte kazetu deionizačního filtru s inhibovaným etylenglykolem nebo inhibovaným propylenglykolem. Deionizační filtr z roztoku odstraňuje inhibitory, takže kapalina přestane narušovat antikorozní ochranu. Inhibitory také zvyšují vodivost kapaliny.

Software chladičích zařízení Polar musí být upravený, aby vyhovoval použité procesní kapalině.

Biocidní přípravky jsou korozivní a mohou způsobit nevratné poškození očí a popáleniny pokožky. Při vdechnutí, spolknutí nebo vstřebání pokožkou jsou škodlivé. Podívejte se do aktuálních bezpečnostních listů výrobce.

Nedostatečně vyčištěný nebo nevyměněný filtr kondenzátoru způsobuje ztrátu chladičí kapacity a vede k předčasnému selhání systému.

U vzduchem chlazených chladičů jsou rámy kondenzátoru a jeho žebra za přední mřížkou velmi ostré.

V případě mřížky chlazené jinak než vzduchem nikdy chladičí zařízení nepoužívejte s demontovanými panely.

Určené použití, recirkulační chladiče:

Recirkulační chladiče společnosti Thermo Scientific jsou navrženy pro zajišťování nepřetržitého přívodu kapaliny při konstantní teplotě a konstantním průtoku. Chladič se skládá ze vzduchem chlazeného nebo vodou chlazeného chladičového systému, tepelného výměníku, recirkulačního čerpadla, nádržky na procesní kapalinu a řídicí jednotky s mikroprocesorem.

Chladiče jsou navrženy pro nepřetržitý provoz a používání ve vnitřních prostorech v souladu se všemi postupy a požadavky, uvedenými v jejich návodech k obsluze.





Instalace, recirkulační chladiče:

Umístěte chladič tak, aby byl v blízkosti svého odpojovacího zařízení a aby byl k odpojovacímu zařízení snadný přístup.

Chladičí zařízení č je určen pro používání se samostatným výstupem.

Před instalací musí být odstraněny všechny přepravní zátky na potrubích a hadicích.

V případě chladičů Polar, aby nemohlo dojít k poškození potrubí a hadic chladiče, použijte při demontáži nebo instalaci externích přípojek 19mm kontra klíč.

Přípojky procesní kapaliny jsou umístěné na zadní části chladiče a jsou označené  (PROCESS INLET – procesní přívod) a  (PROCESS OUTLET – procesní výstup). Připojte  k výstupu kapaliny na zařízení. Připojte  k přívodu kapaliny na zařízení.

Před spuštěním chladiče překontrolujte příslušné komunikační a elektrické přípojky a přípojovací armatury.



Essentiell sikkerhedsvejledning Recirkulerende nedkølere

Hvis nogle af disse instrukser ikke kan forstås, så referer til manualen, eller kontakt os, før du fortsætter.

Sikkerhed, alle produkter:



Indikerer en omgående farlig situation, som, hvis den ikke undgås, vil resultere i død eller alvorlig skade.



Indikerer en potentielt farlig situation, som, hvis den ikke undgås, vil resultere i død eller alvorlig skade.



Indikerer en potentielt farlig situation, som, hvis den ikke undgås, kan resultere i mindre eller moderat skade. Den bruges også til at advare mod usikre fremgangsmåder.



beregnet til at advare brugeren om tilstedeværelsen af ikke-isoleret "farlig spænding" inden for nedkølerens indelukke. Spændings styrke er markant nok til at udgøre risiko for elektrisk stød.



indikerer tilstedeværelsen af varme overflader.



indikerer læs manualen.

Brug ikke udstyret som en steril eller patientforbundet enhed. Derudover er udstyret ikke designet til brug i Klasse I, II eller III farlige steder som defineret af National Electrical Code.

Udstyret er kun designet til indendørs brug. Placer det aldrig et sted, hvor der findes overdreven varme, fugtighed, utilstrækkelig ventilation eller ætsende materialer. Referer til manualen for driftsparametre.

Forbind udstyret til en korrekt jordet stikkontakt.

Kølemidler, der bruges her, er tungere end luft, og hvis der er en læk, vil det erstatte oxygenet, hvilket forårsager tab af bevidsthed. Kontakt med lækkende kølemidler vil forårsage hudforbrændinger. Referer til cirkulatorens navneplade for den type kølemiddel, der bruges, og så producentens mest aktuelle amk. sikkerhedsdataark (SDS), tidligere kendt som MSDS, og EUs sikkerhedsdataark for yderligere oplysninger.

Flyt udstyret forsigtigt. Pludselige stød eller tab kan beskadige dets komponenter. Sluk altid udstyret, og afbryd det fra dets strømforsyning, før det flyttes.

Bedtjen aldrig beskadiget eller lækkende udstyr.

Brug aldrig brændbare eller ætsende væsker. Brug kun tilladte væsker, der er angivet i manualen. Før du bruger nogen væske eller udfører vedligeholdelse, hvor kontakt med væsken er sandsynlig, skal du referere til producentens mest aktuelle amk. sikkerhedsdatablad (SDS) og EUs sikkerhedsdatablad for yderligere oplysninger.

Sluk altid udstyret, og afbryd det fra dets strømforsyning, før det flyttes.

Hvis vedligeholdelse og reparation til en kvalificeret tekniker.

Opbevar udstyret i et temperaturinterval på -25 °C til 60 °C (med indpakning), og <80 % relativ luftfugtighed.

Dekommissionering skal kun udføres af en kvalificeret forhandler, der bruger certificeret udstyr. Alle aktuelle regulativer skal følges.

Udførelse af installation, drift eller vedligeholdelsesprocedurer andre end dem, der er beskrevet i denne manual, kan resultere i en farlig situation og vil annullere producentens garanti.

Stil nedkølere i en oprejst stående position ved stuetemperatur (~25 °C) i 24 før start. Dette sikrer, at smøreolien er drænet tilbage ind i kompressoren.

Polarnedkølere er ikke designet til at blive gulvmonteret.

Påfør aldrig linjespænding til nogen kommunikationsforbindelse på nedkøleren.

Benyt ikke automatisk kølervæske. Kommerciel kølervæske indeholder silikater, der skader pumpeforseglingen.

Når du bruger en procesvæskemikstur af EG/vand eller PG/vand, skal du kontrollere væskekoncentrationen og pH jævnligt. Ændringer i koncentrationen og pH kan have indflydelse på systemydelsen. Brug ikke en deioniserings (DI) filterpatron med inhiberet EG eller inhiberet PG. Et DI-filter vil fjerne inhibitorer fra opløsningen, hvilket gør væsken ineffektiv mod beskyttelse mod korrosion. Inhibitorer forøger også væskens ledeevne.

Polar-nedkøleres software skal justeres til at acceptere den brugte procesvæske.

Biocider er ætsende og kan forårsage irreversibel øjenskade og hudforbrændinger. De er skadelige, hvis de inhaleres, sluges eller absorberes gennem huden. Referer til producentens mest aktuelle SDS.

Hvis kondensatoren ikke rengøres/udskiftes, kan det forårsage et tab af kølekapacitet og føre til tidlig fejlfunktion af kølesystemet.

På luftkølede nedkølere er kondensatorramme og -finer bag fronttritsamlingen meget skarpe.

Ud over den luftkølede ristsamling må du aldrig befjene nedkøleren med nogen aftagne paneler.

Tilsligtet brug, recirkulerende nedkølere:

Thermo Scientific recirkulerende nedkølere er designet til at yde en løbende væskeforsyning ved en konstant temperatur og strømningsrate. Nedkøleren består af et luftkølet eller vandkølet kølesystem, varmeveksler, recirkuleringspumpe, procesvæskeresevoir og en mikroprocessor-controller.

Nedkølere er designet til løbende drift og til indendørs brug i henhold til alle procedurerne og kravene formuleret i denne håndbog.

Installation, recirkulerende nedkølere:

Placer nedkøleren, så den er nær, og har nem adgang til, dens afbryderenhed.

Nedkøleren er beregnet til brug i en dedikeret strømkontakt.

Sørg for, at alle vvs-linjers shipping-stik fjernes før installation.

For Polar-nedkølere kan du forhindre skade på nedkølerens vvs ved at bruge en 19 mm backing-nøgle, når de eksterne stikforbindelser fjernes/installes.

Procesvæskeforbindelserne befinder sig bag på nedkøleren og er markeret  (PROCESS OUTLET) og  (PROCESS INLET). Forbind  til væskeindtaget på din applikation. Forbind  til væskeudløbet på din applikation.

Før du starter nedkøleren, skal du kontrollere alle relevante kommunikations-, elektriske og vvs-forbindelser en ekstra gang.



Βασικές οδηγίες ασφαλείας Ψύκτες επανακυκλοφορίας

Εάν οποιαδήποτε από αυτές τις οδηγίες δεν είναι κατανοητή, ανατρέξτε στο εγχειρίδιο ή επικοινωνήστε μαζί μας πριν προχωρήσετε.

Ασφάλεια, όλα τα προϊόντα:

DANGER Υποδεικνύει άμεση κατάσταση κινδύνου που αν δεν αποφευχθεί, μπορεί να προκαλέσει θάνατο ή σοβαρό τραυματισμό.

WARNING Υποδεικνύει δυνητικά επικίνδυνη κατάσταση που αν δεν αποφευχθεί, μπορεί να προκαλέσει θάνατο ή σοβαρό τραυματισμό.

CAUTION Υποδεικνύει δυνητικά επικίνδυνη κατάσταση που αν δεν αποφευχθεί, μπορεί να προκαλέσει μικρό ή ήπιο τραυματισμό. Μπορεί να χρησιμοποιηθεί και ως προειδοποίηση μη ασφαλών πρακτικών.

 για την προειδοποίηση του χρήστη σχετικά με την παρουσία μην-μονωμένης "επικίνδυνης τάσης" μέσα στο περιβάλλον του ψύκτη. Το μέγεθος της τάσης είναι αρκετά σημαντικό ώστε να αποτελέσει κίνδυνο ηλεκτροπληξίας.

 υποδεικνύει την παρουσία ζεστών επιφανειών

 υποδεικνύει ανόγκωση του εγχειριδίου.

Μη χρησιμοποιείτε τον εξοπλισμό ως αποστειρωμένη συσκευή ή συσκευή συνδεδεμένη με τον ασθενή. Επιπλέον, ο εξοπλισμός δεν έχει σχεδιαστεί για χρήση στην Κατηγορία I, II ή III Επικίνδυνες Θέσεις από τον Εθνικό Ηλεκτρολογικό Κώδικα.

Ο εξοπλισμός έχει σχεδιαστεί για χρήση σε εσωτερικούς χώρους. Μην τοποθετείται ποτέ σε τοποθεσία με υπερβολική θερμότητα, υγρασία, ανεπαρκή αερισμό ή διαβρωτικά υλικά. Ανατρέξτε στις λειτουργικές παραμέτρους του εγχειριδίου.

Συνδέστε τον εξοπλισμό σε κατάλληλα γεωμνημένη έξοδο.

Τα ψυκτικά που χρησιμοποιούνται είναι βαρύτερα από τον αέρα και εάν υπάρχει διαρροή, θα αντικαταστήσουν το οξυγόνο και θα προκαλέσουν απώλεια αισθήσεων. Η επαφή με ψυκτικό διαρροής θα προκαλέσει εγκαύματα στο δέρμα. Ανατρέξτε στην πινακίδα για τον τύπο του ψυκτικού που χρησιμοποιείται και το τρέχον Φύλλο Δεδομένων Ασφαλείας Η.Π.Α (SDS) γνωστά ως MSDS και το Φύλλο Δεδομένων Ασφάλειας Ε.Ε. για περισσότερες πληροφορίες.

Μετακινήστε τον εξοπλισμό με προσοχή. Ξαφνικά τραντάγματα ή πτώσεις ενδέχεται να προκαλέσει βλάβες στα εξαρτήματα. Πάντα σβήνεται τον εξοπλισμό και αποσυνδέστε τον από την παροχή τάσης, πριν από τη μετακίνησή του.

Ποτέ μη λειτουργείτε εξοπλισμό που έχει υποστεί βλάβη ή παρουσιάζει διαρροές.

Ποτέ μη χρησιμοποιείτε εύφλεκτα ή διαβρωτικά υγρά. Χρησιμοποιήστε μόνο εγκεκριμένα υγρά που αναφέρονται στο εγχειρίδιο. Πριν χρησιμοποιήσετε οποιοδήποτε υγρό ή κατά τη διαδικασία της συντήρησης όπου η επαφή με το υγρό είναι πιθανή, ανατρέξτε στα Φύλλα Δεδομένων Ασφαλείας SDS και EC για περισσότερες πληροφορίες.

Πάντα σβήνεται τον εξοπλισμό και αποσυνδέστε τον από την παροχή τάσης, πριν από τη μετακίνησή του. Για σέρβις και επισκευές απευθυνθείτε σε εξειδικευμένο τεχνικό.

Αποθηκεύστε τον εξοπλισμό σε θερμοκρασία μεταξύ -25°C και 60°C (με τη συσκευασία) και σε σχετική υγρασία <80%.

Η θέση εκτός λειτουργίας θα πρέπει να εκτελείται από εξειδικευμένο προμηθευτή με τη χρήση πιστοποιημένου εξοπλισμού. Όλοι οι κανονισμοί εν ισχύ θα πρέπει να τηρούνται.

Οι διαδικασίες εγκατάστασης, λειτουργίας ή συντήρησης εκτός από εκείνες που περιγράφονται στο εγχειρίδιο ενδέχεται να προκαλέσουν επικίνδυνες καταστάσεις και ακύρωση της εγγύησης του κατασκευαστή.

Αφήντε τους ψύκτες σε κατακόρυφη θέση, σε θερμοκρασία δωματίου (~25°C) για 24 ώρες πριν την έναρξη. Αυτό εξασφαλίζει ότι το λάδι λίπανσης θα εισρεύσει μέσα στον συμπιεστή.

Οι πύργοι ψύξης Polar δεν έχουν σχεδιαστεί για να τοποθετούνται στο δάπεδο.

Ποτέ μην εφαρμόζετε τάση γραμμής σε οποιαδήποτε σύνδεση επικοινωνίας επί του ψύκτη.

Μη χρησιμοποιείτε αντιψυκτικό αυτοκινήτου. Τα αντιψυκτικά του εμπορίου περιέχουν πυρίτιο που προκαλεί ζημιά στις στεγανοποιήσεις.

Κατά τη χρήση μειγματος υγρού EG/νερού ή PG/νερού, ελέγχετε τη συγκέντρωση και το pH σε τακτά χρονικά διαστήματα. Οι αλλαγές σε συγκέντρωση και pH ενδέχεται να επηρεάσουν τις επιδόσεις του συστήματος. Μη χρησιμοποιείτε φυσίγγιο φίλτρου απιονισμού (DI) με αναστολέα EG ή αναστολέα PG.

Ένα φίλτρο DI θα αφαιρέσει τους αναστολείς από το διάλυμα, καθιστώντας το υγρό αναποτελεσματικό κατά την προστασία από τη διάβρωση. Επίσης, οι αναστολείς αυξάνουν την αγωγιμότητα του υγρού. Το λογισμικό των ψυκτών

Polar θα πρέπει να ρυθμιστεί ώστε να συμμορφώνεται με το υγρό που χρησιμοποιείται.

Τα βιοκτόνα είναι διαβρωτικά και μπορούν να προκαλέσουν μη αναστρέψιμη βλάβη στα μάτια και εγκαύματα στο δέρμα. Είναι βλαβερά κατά την εισπνοή, την κατάποση και την απορρόφηση από το δέρμα. Ανατρέξτε στο τρέχον φύλλο SDS του κατασκευαστή.

Ο μη καθαρισμός ή η μη αντικατάσταση του φίλτρου συμπυκνωτή προκαλεί απώλεια ικανότητας ψύξης και θα οδηγήσει σε πρώιμη στοχία του συστήματος ψύξης. Για καλό καθαρισμό αφαιρέστε την εμπρός γρίλια της συναρμολογής.

Σε αερόψυκτους ψύκτες το πλαίσιο του συμπυκνωτή και τα πτερύγια που βρίσκονται πίσω από την εμπρός σχάρα είναι πολύ κοφτερά.

Εκτός από την αερόψυκτη συναρμολογή της γρίλιας, ποτέ μην λειτουργείτε τον ψύκτη με βγαλμένα τα πλαίσια.

Προοριζόμενη χρήση, Ψύκτες επανακυκλοφορίας:

Οι ψύκτες επανακυκλοφορίας Thermo Scientific έχουν σχεδιαστεί για να παρέχουν συνεχή παροχή υγρού σε σταθερή θερμοκρασία και ροή. Ο ψύκτης αποτελείται από ένα αερόψυκτο ή υδρόψυκτο σύστημα ψύξης, έναν εναλλάκτη θερμότητας, μία αντλία επανακυκλοφορίας, μία δεξαμενή υγρού και έναν ελεγκτή μικροεπεξεργαστή.

Οι ψύκτες έχουν σχεδιαστεί για συνεχόμενη λειτουργία σε εσωτερικούς χώρους σύμφωνα με τις διαδικασίες και τις απαιτήσεις που ορίζει το παρόν εγχειρίδιο.



Εγκατάσταση, Διατάξεις ψύξης επανακυκλοφορίας:

Τοποθετήστε τη διάταξη ψύξης έτσι ώστε να είναι κοντά, με εύκολη στη διάταξη αποσύνδεσης.

Ο ψύκτης προορίζεται για χρήση σε αντίστοιχη έξοδο.

Βεβαιωθείτε ότι όλα τα πτώματα συσκευασίας στις υδραυλικές σωληνώσεις έχουν αφαιρεθεί πριν την εγκατάσταση.

Για τους ψύκτες Polar, για την αποφυγή βλαβών στα υδραυλικά του ψύκτη, χρησιμοποιήστε ένα κλειδί 19 mm κατά την αφαίρεση/εγκατάσταση των εξωτερικών συνδέσεων.

Οι συνδέσεις υγρού της διαδικασίας βρίσκονται στο πίσω μέρος του ψύκτη και έχουν ετικέτα (ΕΞΟΔΟΣ ΔΙΑΔΙΚΑΣΙΑΣ) και  και (ΕΙΣΟΔΟΣ ΔΙΑΔΙΚΑΣΙΑΣ). Συνδέστε το  στην είσοδο του υγρού της εφαρμογής σας. Συνδέστε το  στην έξοδο του υγρού της εφαρμογής σας

Πριν την έναρξη του ψύκτη, ελέγξτε με προσοχή την επικοινωνία και τις ηλεκτρικές και υδραυλικές συνδέσεις.



Olulised ohutusjuhised Ringlusega jahutid

Kui mistahes juhised ei ole arusaadavad, siis enne jätkamist vaadake kasutusjuhendit.

Ohutus, kõik tooted:

 tähistab otsest ohtlikku olukorda, millele tähelepanu pööramata jätmine võib põhjustada surma või tõsise vigastuse.

 tähistab potentsiaalselt ohtlikku olukorda, millele tähelepanu pööramata jätmine võib põhjustada surma või tõsise vigastuse.

 tähistab potentsiaalselt ohtlikku olukorda, millele tähelepanu pööramata jätmine võib põhjustada väiksema või keskmise raskusega vigastuse. Seda kasutatakse ka ohtlikust tegevusest hoiatamiseks.

 ettenähtud kasutaja hoiatamiseks jahuti korpuses olevast isoleerimata "ohtlikust pingest". Pinge tugevus on piisav elektritöögi tekitamiseks.

 tähistab kuumade pindade olemasolu.

 tähistab kasutusjuhendi vaatamise vajadust.

Ärge kasutage seadmeid steriilsete seadmetena või patsiendiga ühendatavate seadmetena. Lisaks eelnevale, ei ole seadmed ettenähtud kasutamiseks I, II või III klassi ohtlikes rakendustes vastavalt NEC nõuetele.

Seadmed on ettenähtud kasutamiseks ainult siseruumides. Ärge kunagi paigutage ülemäärase kuumusega, niiskusega, ebapiisava ventilatsiooniga kohtadesse või soovitatavate materjalide lähedale. Vaadake tööparameetreid kasutusjuhendist.

Ühendage seade nõuetekohaselt maandatud seinapistikuga.

Kasutatavad jahutusained on õhust raskemad ning tõrjuvad lekke korral õhu välja ning võivad põhjustada meelemärkuse kadu. Lekkiva jahutusainega kokkupuutumine põhjustab nahapõletusi. Lisateabeaks kasutatava jahutusaine kohta vaadake ringluspumba andmeplaati ja tootja kõige hilisemat ohutuskaarti (SDS, MSDS, EL ohutuskaart).

Liigutage seadet ettevaatlikult. Ootamatud põrutused ja kukkumised võivad kahjustada seadme

komponente. Enne seadme liigutamist lülitage seade alati välja ja ühendage lahti toitevõrgust.

Ärge kasutage kunagi kahjustatud või lekkivaid seadmeid.

Ärge kasutage kunagi süttimisohutikke või soovitavaid vedelikke. Kasutage ainult kasutusjuhendis heakskiidetud vedelikke. Enne mistahes vedelike kasutamist või hooldustööde läbiviimist vaadake lisateabeks tootja kõige hilisemat ohutuskaarti (SDS, MSDS, EL ohutuskaart).

Enne seadme liigutamist lülitage seade alati välja ja ühendage lahti toitevõrgust.

Hooldamisel ja remondi korral pöörduge kogemustega tehniku poole.

Hoidke seadmeid temperatuurivahemikus -25°C kuni 60°C (pakendis) ja <80% suhtelise niiskuse juures.

Kasutusest eemaldamisel pöörduge sertifitseeritud seadmeid kasutava kogemustega ettevõtte poole. Järgige kõiki kehtivaid eeskirju.

Kasutusjuhendis kirjeldamata paigaldamis-, töötamis- või hooldusprotseduurid võivad kaasa tuua ohtliku olukorra ning muudavad garantii kehtetuks.

Polar jahutid ei ole ettenähtud paigaldamiseks pörandale. Enne käivitamist jätke jahutid püstisesse asendisse toatemperatuuril (~25°C) 24-ks tunniks. See tagab määrdeõli voolamise tagasi kompressorisse.

Ärge kunagi rakendage võrgupinget jahuti mistahes andmesideühendustele.

Ärge kasutage sõidukite jahutusvedelikku. Kaubanduses kättesaadavad jahutusvedelikud sisaldavad silikaate, mis kahjustavad pumba tihendeid.

Kui kasutate töövedelikuna EG/vesi või PG/vesi segu, siis kontrollige regulaarselt kontsentratsiooni ja pH-taset. Kontsentratsiooni ja pH-taseme muutused võivad mõjutada süsteemi töötamist.

Ärge kasutage deioniseerimise (DI) filtrikassetti koos inhibeeritud EG-ga või inhibeeritud PG-ga. DI filter eemaldab lahusest inhibiitorid, vähendades vedeliku korrosioonivastast mõju. Lisaks sellele suurendavad inhibiitorid vedeliku juhitavust.

Polar jahuti tarkvara peab olema seadistatud vastavalt kasutatavatele töövedelikele.

Biotsiidid on soovitatavad ning võivad põhjustada pöördumatuid silmakahjustusi ja nahapõletusi. Nad on ohtlikud sissehingamisel, allaneelamisel ja imendumisel läbi naha. Vaadake tootja kõige hilisemat ohutuskaarti.

Kondensaatori filtri puhastamise/asendamise nõuete mittejärgimine põhjustab jahutusvõimsuse vähenemise ja jahutussüsteemi enneaegse purunemise.

Õhkjahutusega jahutite esivõre taga asuva kondensaatori raamistik ja ribid on väga teravad.

Ärge kunagi kasutage eemaldatud paneelidega jahutit.

Kasutuseesmärk, ringlusega jahutid:

Thermo Scientific ringlusega jahutid on ettenähtud pideva temperatuuriga ja voolukiirusega vedeliku voolamise tagamiseks. Jahuti koosneb õhkjahutusega või vesijahutusega jahutusüsteemist, soojusvahetist, ringluspumbast, töövedeliku mahutist ja mikroprotsessoriga juhtimissüsteemist.

Jahutid on ettenähtud pidevaks töötamiseks sisetingimuteses vastavalt kasutusjuhendis sätestatud protseduuridele ja nõuetele.

Paigaldamine, ringlusega jahutid:

Paigutage jahuti nii, et selle väljalülitamise seadmele on lihtne juurde pääseda.

Jahutile peab olema ettenähtud eraldi seinakontakt.

Veenduge, et torustiku transpordikorgid on enne paigaldamist eemaldatud.

Jahuti torustiku kahjustamise ärahoidmiseks kasutage Polar jahutite siseliitmike eemaldamisel/ paigaldamisel 19 mm siilusvõtit.

Töövedeliku ühendused asuvad jahuti tagaosas ning on tähistatud  (PROCESS OUTLET) (sisend)

ja  (PROCESS INLET) (väljuund). Ühendage  oma seadme vedeliku sisendiga. Ühendage

 oma seadme vedeliku väljuundiga.

Enne jahuti käivitamist kontrollige üle kõik kasutatavad andmesideühendused, elektrihühendused ja toruühendused.

FJ

Olennaiset turvaohjeet Kiertojäähdyttimet

Jos nämä ohjeet eivät ole selvää, viittaa ohjekirjaan tai ota meihin yhteyttä ennen kuin jatkat eteenpäin.

Turvallisuus, kaikki tuotteet:

DANGER osoittaa välitöntä vaaratilannetta, joka johtaa kuolemaan tai vakavaan loukkaantumiseen, ellei sitä vältetä.

WARNING osoittaa potentiaalisen vaaratilanteen, joka voi johtaa kuolemaan tai vakavaan loukkaantumiseen, ellei sitä vältetä.

CAUTION osoittaa potentiaalisen vaaratilanteen, joka saattaa aiheuttaa pienen tai kohtalaisen vamman, ellei sitä vältetä. Sitä käytetään varoittamaan myös vaarallisista tavoista.

 tarkoitettu varoittamaan käyttäjää eristämättömästi "vaarallisesta jännitteestä" jäähdyttimen kotelon sisällä. Jännitteen voimakkuus on merkittävä sähköiskuvaaran aiheuttamiseksi.

 osoittaa kuumien pintojen paikallaoloa.

 osoittaa ohjekirjan lukemiseen liittyvää velvoitusta.

Älä käytä laitetta steriilinä varusteena tai potilaaseen yhdistettynä. Laitetta ei ole suunniteltu käytettäväksi National Electrical Code -sääntöjen mukaisesti I, II tai III luokan tiloissa.

Laitte on tarkoitettu käytettäväksi vain sisätiloissa. Älä koskaan sijoita sitä paikkoihin joissa esiintyy liiallista kuumuutta, kosteutta, riittämätön tuuletus tai syövyttäviä materiaaleja. Viittaa ohjekirjaan käyttöparametrejä varten.

Liitä laite maadoitettuun pistorasiaan.

Käytetyt jäähdytysaineet ovat ilmaan verrattuna painavampia, ja jos vuotoa esiintyy, se korvaa hapen aiheuttamalla tajun menettämisen. Kosketus vuotavaan jäähdytysaineeseen aiheuttaa palovammoja.

Lisätietoja varten viittaa kiertoilimen arvokilpeen koskien käytettyä jäähdytysainetta ja valmistajan päivitetyihin käyttöturvallisuustietoihin (US Safety Data Sheet - SDS), jotka tunnettiin aiemmin nimellä MSDS, sekä EU:n käyttöturvallisuustietoihin.

Siirrä laitetta varovaisesti. Äkilliset tärisykset tai putoamiset voivat vahingoittaa siihen kuuluvia osia. Sammuta laite ja kytkä se irti jännitelähteestä ennen sen liikuttamista.

Älä koskaan käytä laitetta jos se on vahingoittunut tai siinä esiintyy vuotoja.

Älä koskaan käytä tulenarkoja tai syövyttäviä nesteitä. Käytä vain ohjekirjassa lueteltuja hyväksytyjä nesteitä. Ennen nesteiden käyttöä tai huoltotoimenpiteiden suorittamista, joihin liittyy kosketus nesteeseen, viittaa valmistajan päivitettiin käyttöturvallisuustietoihin (US Safety Data Sheet - SDS) ja EU:n käyttöturvallisuustietoihin lisätietoja varten.

Sammuta laite ja kytkä se irti jännitelähteestä aina ennen sen liikuttamista.

Jätä korjaus- ja huoltotyöt pätevän teknikon tehtäväksi.

Säilytä laitetta -25 °C - 60 °C lämpötilassa (pakkauksen kanssa), ja suhteellisen kosteuden ollessa <80 %.

Käytöstä poistaminen on suoritettava yksinomaan pätevän jälleenmyyjän toimesta sertifioituja varusteita käyttämällä. Noudata kaikkia voimassa olevia määräyksiä.

Muiden kuin tässä ohjekirjassa kuvattujen asennus-, käyttö- tai huoltotoimenpiteiden suorittaminen voi aiheuttaa vaarallisen tilanteen ja mitätöidä valmistajan myöntämän takuun.

Polar-jäähdyttimiä ei ole suunniteltu lattia-asennettaviksi. Jätä jäähdyttimet pystyasentoon huonelämpötilaan (~25 °C) 24 tunniksi ennen niiden käynnistystä. Tämä takaa voiteluöljyn paluun kompressoriin.

Älä koskaan syötä linjajännitettä jäähdyttimessä oleviin yhteysliitoksiin.

Älä käytä ajoneuvoille tarkoitettuja pakkasnesteitä. Myynnissä olevat pakkasnesteet sisältävät siikaatteja, jotka vahingoittavat pumpun tiivisteitä.

Kun EG/vesi- tai PG/vesi-nesteseosta käytetään, tarkista säännöllisin väliajoin nesteen pitoisuus ja pH-arvo. Pitoisuuden ja pH-arvon muutokset voivat vaarantaa järjestelmän suorituskykyä.

Älä käytä deionisoivaa (DI) suodatuspatruunaa estetyt EG:n tai PG:n kanssa. DI-suodatin poistaa inhibiittorit nesteestä, tekemällä nesteestä tehottoman syöpymistä vastaan. Inhibiittorit lisäävät lisäksi nesteen johtavuutta.

Polar-jäähdyttimien ohjelmisto on säädettävä käytetyn nesteen mukaan.

Biosidit ovat syövyttäviä ja voivat aiheuttaa parantumattomia silmävaurioita ja palovammoja. Ne ovat vaarallisia jos niitä hengitetään, niellään tai ne imeytyvät ihon kautta. Viittaa valmistajan päivitetyihin SDS-asiakirjoihin.

Lauhduttimen suodatimen puhdistamisen/vaihdon suorittamatta jättäminen aiheuttaa jäähdytyskapasiteetin vähenemistä ja johtaa jäähdytysjärjestelmässä syntyviin ennenaikaisiin vikoihin. Perusteellista puhdistusta varten, irrota eturitiläyksikkö.

Ilmajäähdytteissä jäähdyttimissä eturitiläyksikön takana sijaitsevat lauhduttimen siivekkeet ja kehikko ovat erittäin teräviä.

Älä koskaan käynnistä jäähdytintä kun paneelit on irrotettu.

Käyttötarkoitus, kiertojäähdyttimet:

Thermo Scientific kiertojäähdyttimet on suunniteltu jatkuvan nesteen syöttöön vakaassa lämpötilassa ja virtausarvossa. Jäähdytin koostuu ilma- tai vesijäähdytteisestä jäähdytysjärjestelmästä, lämmönvaihtimesta, kiertopumpusta, prosessinesteen säiliöstä ja mikroprosessori-ohjaimesta.

Jäähdyttimet on suunniteltu jatkuvaan käyttöön sisätiloissa tässä ohjekirjassa määritettyjen menettelyjen ja vaatimusten mukaisesti.

Asennus, kiertojäähdyttimet:

Aseta jäähdytin siten, että siihen kuuluvaan irtikytkentälaitteeseen päästään helposti.

Jäähdytintä on käytettävä yksinomaan sen käyttöön tarkoitettulla pistorasialla.

Varmista, että kaikki lähetyksessä käytetyt putkitulpat on irrotettu ennen sen asennusta.

Polar-jäähdyttimissä, estääksesi jäähdyttimen putkille syntyviä vahinkoja, käytä 19 mm:n avainta ulkoisten liitäntöjen irrottamisessa/asentamisessa.

Prosessinesteen liitännät sijaitsevat jäähdyttimen takaosassa ja ne on merkitty  (PROCESS OUTLET) ja  (PROCESS INLET). Liitä  sovelluksessasi olevaan nesteeseen sisäänmenoos. Liitä  sovelluksessasi olevaan nesteeseen ulostuloon.

Vesijäähdytteisissä jäähdyttimissä, liitä  (FACILITY INLET) järjestelmän vedensyöttöön. Liitä (FACILITY OUTLET) järjestelmän paluuveteen tai viemäriin.

Ennen jäähdyttimen käynnistystä, tarkista kaikki yhteyslinjat sekä sähkö- ja vesiliitokset.



Treoracha Riachtanacha Sábháilteachta

Fuarthóirí Athfhillteacha

Má tá aon treoir ann nach dtuigtear, ceadaiġh an lámhleabhar nó déan teagmháil linn sula dtéann tú níos faide.

Sábháilteacht, gach táirge:

DANGER léiriomn sé staid ghuaiseach as a leanfaidh bás nó tromghortú, mura seachnaítear í.

WARNING léiriomn sé staid ghuaiseach, a bhféadfadh bás nó tromghortú a bheith ina thoradh air, mura seachnaítear í.

CAUTION léiriomn sé staid ghuaiseach, as a leanfaidh mionghortú nó dochar measartha, mura seachnaítear í. Úsáidtear é, leis, chun rabhadh a thabhairt i gcás cleachtais neamhshábháilte.

 ceaptha leis an úsáideoir a chur ar an eolas maidir le “voltas contúirteach” neamhinslithe laistigh d’imfhálú an fhuarthóra. Tá méid an voltais suntasach a dhóthain le bheith ina bhaol turrainge leictirí.

 léiriomn sé dromchlaí te.

 léiriomn sé gur chóir an lámhleabhar a léamh.

Ná húsáid an trealamh mar ghléas steiriúil ná mar ghléas a nasctar le hothar. Lena chois sin, níor ceapadh an trealamh lena úsáid i Láithreacha Guaiseacha A/cmce I, II nó III mar a shainmhínítear sa Chód Náisiúnta Leictreach.

Trealamh atá ceaptha le húsáid isifigh amháin. Ná suigh riamh é in áit ina bhfuil teas iomarcach, taise, aerú neamhdhóhanach nó ábhair chreimneacha. Ceadaiġh an lámhleabhar go bhfeice tú na paraiméadair oibriúcháin.

Ceangail an trealamh d’asraon atá talmhaithe i gceart.

Is airde ná aer na cuisneáin a úsáidtear, agus má bhíonn sceitheadh ann, gabhfaidh siad áit na hocsaigne as a leanfaidh cailliúint comhfheasa. Dófar craiceann má bhíonn teagmháil idir craiceann agus cuisneán atá ag sceitheadh. Féach ainmphiáta an dáileora go bhfeice tú an cineál cuisneáin a úsáidtear agus ansin féach Leathanach Sonraí Sábháilteachta SA is déanaí an déantóra, an rud a dtugtaí an MSDS air cheana, agus Leathanach Sonraí Sábháilteachta an AE chun breis eolais a fháil.

Bí cúramach agus tú ag bogadh an trealaimh. Is féidir le croitheadh nó íslíú tobann na comhpháirteanna a dhamáistiú. Cas an trealamh as i gconal agus dicheangail é den voltais soláthair sula mbogann tú é.

Ná hoiibrigh riamh trealamh damáistithe nó trealamh atá ag sceitheadh.

Ná húsáid leacht inadhaite nó creimneach riamh. Ná húsáid ach na leachtanna ceadaithe atá liostaithe sa lámhleabhar. Sula n-úsáidtear aon leacht nó sula ndéantar cothabháil ina bhféadfaí teagmháil a dhéanamh leis an leacht, ceadaiġh Leathanach Sonraí Sábháilteachta SA is déanaí an déantóra agus Leathanach Sonraí Sábháilteachta an AE chun breis eolais a fháil.

Cas an trealamh as i gconal agus dicheangail é den voltais soláthair sula mbogann tú é.

Iarr ar theicneoir cáiliithe gach seirbhísiú agus deisiú a dhéanamh.

Stóráil an trealamh sa raon teochta -25°C go 60°C (in éineacht leis an bpacáistiú), agus i dtaiseacht choibhneasta <80%.

Níor chóir ach do dhéileálai cáiliithe, a úsáideann trealamh deimhniithe, an gléas a dhíchoimisiúnú. Ní mór cloí le gach rialachán atá i bhfeidhm.

Féadfaidh staid ghuaiseach agus cur ar neamhni bharánta an déantóra a bheith ina thoradh ar fheidhmíú nósanna imeachta suiteála, oibríúcháin nó cothabhála seachas iad siúd a ndéantar cur síos orthu sa lámhleabhar.

Níor dearadh fuarthóirí Polar lena suí ar an uinír. Fág fuarthóirí ina seasamh go hingearach ag teocht an tseomra (~25°C) ar feadh 24 uaire sula dtosaítear iad. Cinntíomn sé sin go ndraenálann an ola bealaithe ar ais isteach sa chomhbhrúiteoir.

Ná húsáid voltais line riamh le haon cheann de na naisc chumarsáide ar an bhfuarthóir.

Ná húsáid oibreán frithreo uathghluaisneach. Tá sileacáit in oibreán frithreo uathghluaisneach a dhamáisiomn séalai caidéli.

Agus meascán leachta próisis de EG/uisce nó PG/uisce á úsáid, seiceáil túchan an leachta agus an pH ar bhonn rialta. Is féidir le hathruithe ar thiúchan agus ar pH difear a dhéanamh d’fheidhmíocht córais.

Ná húsáid cartús scagaire dí-ianúcháin (DI) le EG Coiscthe nó PG Coiscthe. Bainfidh scagaire DI coscairí den tuaslagán a fhágfaidh an leacht neamhéifeachtach mar chosaint ar chreimeadh. Ina theannta sin, méadaíomn coscairí seoltacht leachta.

Ní mór bogearraí an fhuarthóra Polar a choigeantú chun go n-oirfidh siad don leacht próisis a úsáidtear.

Is oibreáin chreimneacha iad bithicíidí agus is féidir leo damáiste doleigheasta a dhéanamh don tsuíil agus an craiceann a dhó. Déanann siad damáiste má dhéantar iad a anáilú, a shlogadh nó a ionsú tríd an gcráiceann. Ceadaiġh an SDS is déanaí ón déantóir.

Mura ndéantar an scagaire comhdhlúthadáin a ghlanadh/a athchur, cailítear cumas fuarthóra agus d’fhéadfadh an córas fuaraithe teip roimh am. Chun glanadh iomlán a dhéanamh, bain cóimeáil na greille tosaigh.

Ar fhuarthóirí aerfhuaraithe bíonn an fhrámáil agus na heití atá suite laistigh de chóimeáil na greille tosaigh an-ghéar.

Seachas an chóimeáil ghreille aerfhuaraithe, ná hoiibrigh an fuarthóir riamh agus aon cheann de na painéil bainte.

Úsáid Cheaptha, Fuarthóirí Athfhillteacha:

Dearadh fuarthóirí athfhillteacha Thermo Scientific le soláthar leanúnach leachta a sholáthar ag teocht agus ar ráta sreafa seasmhach. Is éard atá san fuarthóir córas cuisniúcháin aerfuaraithe nó uiscefuaraithe, teasmhalatóir, caidéal athfhillteach, taiscumar leachta próisis agus rialtóir micreaphróiseálaí.

Tá fuarthóirí ceaptha le haghaidh oibriú leanúnach agus le húsáid laistigh de réir na nósanna imeachta agus na riachtanas atá luaite sa lámhleabhar a ghabhann leis.





Le Fuarthóirí Athfhillteacha a Shuiteáil:

Suigh an fuarthóir gar dá ghleas dícheangail, agus sa tsí go bhfuil fáil ar an ngléas sin go héasca.

Tá an fuarthóir ceaptha le húsáid ar asraon íomnaithe.

Cinntigh go mbaintear gach plocóid seolta líne pluiméireachta sula ndéantar an tsuiteáil.

I gcás fuarthóirí Polar, chun damáiste do phluiméireacht an fhuarthóra a sheachaint, úsáid rinse tacaíochta 19 mm agus na naisc sheachtracha á mbaint/á suiteáil.

Tá na naisc leachta próisis suite ar chúil an fhuarthóra agus tá siad lipéadaithe  (PROCESS OUTLET (ASRAON PRÓISIS)) agus  (PROCESS INLET (IONRAON PRÓISIS)). Ceangail an  leis an ionraon leachta ar d'fheidhmíochán. Ceangail an  leis an asraon leachta ar d'fheidhmíochán.

Sula dtosaítear an fuarthóir, seiceáil faoi dhó gach cumarsáid infheidhmithe, agus gach nasc leictreach agus pluiméireachta.

Osnovne sigurnosne uput Cirkulirajući rashladni uređaji

Ako ne razumijete bilo koje od ovih uputa, pogledajte priručnik ili nas kontaktirajte prije nego što nastavite.

Sigurnost, svi proizvodi:



označava neposrednu opasnost koja će, ako se ne izbjegne, uzrokovati smrt ili tešku ozljedu.



označava moguću opasnu situaciju koja, ako se ne izbjegne, može uzrokovati smrt ili tešku ozljedu.



označava moguću opasnu situaciju koja, ako se ne izbjegne, može uzrokovati manju ili srednje tešku ozljedu. Također se može koristiti da upozori na nesigurne radnje.



upozorava korisnika na prisutnost neizoliranog „opasnog napona“ unutar kućišta rashladnog uređaja. Napon je dovoljno velik da predstavlja opasnost od strujnog udara.



ukazuje na prisutnost vrućih površina.



ukazuje da je potrebno pročitati priručnik.

Nemojte koristiti opremu kao sterilni proizvod ili proizvod povezan na pacijenta. Pored toga, oprema nije predviđena za upotrebu na opasnim lokacijama klase I, II ili III prema definicijama Nacionalnog električnog standarda (engl. National Electrical Code).

Oprema je predviđena isključivo za upotrebu u zatvorenim prostorima. Nikad je nemojte postavljati gdje je prisutna prekomjerna toplina, vlažnost, neodgovarajuće prozračivanje ili nagrizajući materijali. Radni parametri navedeni su u priručniku.

Povežite opremu na pravilno uzemljenu utičnicu.

Korištena sredstva za hlađenja teža su od zraka i, ako dođe do curenja, zamijenit će kisik te dovesti do gubitka svijesti. Kontakt sa sredstvom za hlađenje koje curi uzrokuje opekline. Pogledajte natpisnu pločicu cirkulatora za vrstu korištenog sredstva za hlađenje, a zatim potražite dodatne informacije u najnovijem sigurnosno-tehničkom listu za SAD (engl. Safety Data Sheet, SDS), ranije poznatom kao MSDS, kao i sigurnosno-tehničkom listu za EU.

Oprezno pomjerajte opremu. Naglo drmanje ili ispuštanje opreme može oštetiti njene komponente. Prije pomjeranja oprema uvijek je isključite i iskopčajte iz napona izvora napajanja.

Nikad nemojte koristiti oštećenu opremu ili opremu koja propušta.

Nikad nemojte koristiti zapaljive ili nagrizajuće tekućine. Koristite samo odobrene tekućine navedene u priručniku. Prije korištenje bilo kakve tekućine ili obavljanja postupaka održavanja u kojima će vjerojatno doći do kontakta s tekućinom, potražite dodatne informacije u najnovijem sigurnosno-tehničkom listu za SAD (engl. Safety Data Sheet, SDS) i sigurnosno-tehničkom listu za EU.

Prije pomjeranja oprema uvijek je isključite i iskopčajte iz napona izvora napajanja.

Servisiranje i popravke treba obavljati kvalificirani serviser.

Opremu držite na rasponu temperature od -25 °C do 60 °C (s pakiranjem) i relativnoj vlažnosti od <80 %.

Stavljanje izvan pogona mora obaviti isključivo kvalificirani trgovac pomoću certificirane opreme. Moraju se slijediti svi važeći propisi.

Obavljanje postupaka ugradnje, korištenja ili održavanja koji nisu opisani u priručniku može dovesti do opasne situacije i poništiti će jamstvo proizvođača.

Prije pokretanja ostavite rashladni uređaj u uspravnom položaju 24 sata na sobnoj temperaturi (~25 °C).

Na ovaj se način osigurava da ulje za podmazivanje istekne nazad u kompresor.

Polarni rashladni uređaji nisu predviđeni za podno montiranje.

Nikad nemojte primjenjivati linijski napon na komunikacijske priključke na rashladnom uređaju.

Nemojte koristiti antifriz za automobile. Komercijalni antifriz sadrži silikate koji oštećuju brtve pumpe.

Prilikom upotrebe smjese radne tekućine od etilen glikola/vode ili propilen glikola/vode, redovito provjeravajte koncentraciju tekućine i pH vrijednost. Promjene u koncentraciji i pH vrijednosti mogu utjecati na performanse sustava.

Nemojte koristiti uložak filtra za deioniziranje s inhibiranim etilen glikolom ili inhibiranim propilen glikolom. Filtrar za deioniziranje uklanja inhibitore iz otopine, što tekućinu čini nedjelotvornom u zaštiti od korozije. Pored toga, inhibitori povećavaju provodljivost tekućine.

Softver polarnog rashladnog uređaja mora se prilagoditi kako bi odgovarao korištenoj radnoj tekućini.

Biocidi su nagrizajući i mogu uzrokovati nepopravljiva oštećenja očiju i opekline. Štetni su ako se udahnu, progutaju ili upiju kroz kožu. Pogledajte najnoviji sigurnosno-tehnički list proizvođača.

Predviđena namjena, cirkulirajući rashladni uređaji:

Cirkulirajući rashladni uređaji tvrtke Thermo Scientific predviđeni su za pružanje kontinuirane isporuke tekućine uz konstantnu temperaturu i protok. Rashladni uređaj se sastoji od zrakov hladnog ili vodom hladnog rashladnog sustava, izmjenjivača topline, cirkulirajuće pumpe, rezervoara radne tekućine i kontrolera mikroprocesora.

Rashladni uređaji su predviđeni za kontinuirani rad i primjenu u zatvorenim prostorima u skladu sa svim postupcima i zahtjevima navedenim u njihovim priručnicima.



Ugradnja, cirkulirajući rashladni uređaji:

Postavite rashladni uređaj tako da je blizu i ima jednostavan pristup svom uređaju za iskopčavanje.

Rashladni uređaj je predviđen za upotrebu na namjenskoj utičnici.

Obavezno skinite sve ambalažne čepove vodovodnih crijeva prije ugradnje.

Kod rashladnih uređaja Polar, kako bi se spriječilo oštećenje vodovoda rashladnog uređaja potrebno je koristiti podešavajući kličuč od 19 mm za skidanje/postavljanje vanjskih priključaka.

Priključni rashladne tekućine nalaze se sa stražnje strane rashladnog uređaja i označeni su sa  (PROCESS OUTLET) (radni izlazni otvor) i  (PROCESS INLET) (radni ulazni otvor). Povežite  na ulazni otvor za tekućinu na vašem uređaju. Povežite  na izlazni otvor za tekućinu na vašem uređaju.

Kod vodom hlađenih rashladnih uređaja povežite  (FACILITY INLET) (ulazni otvor za postrojenje) na vodovod postrojenja. Povežite  (FACILITY OUTLET) (izlazni otvor za postrojenje) na povratni vod ili odvod postrojenja.

Prije pokretanja rashladnog uređaja dvaput provjerite sve relevantne komunikacijske, električne i vodovodne priključke.

Alapvető biztonsági utasítások Recirkulációs hűtők

Ha valamelyik utasítást nem érti, lapozza fel a kézikönyvet, vagy forduljon hozzánk, mielőtt folytatná a munkát.

Biztonság – összes termék:



Közvetlen veszélyhelyzetet jelez, amely halált vagy súlyos sérülést okoz, ha meg nem előzik.



Potenciálisan veszélyes helyzetet jelez, amely halált vagy súlyos sérülést okoz, ha meg nem előzik.



Potenciálisan veszélyes helyzetet jelez, amely enyhe, vagy közepes sérülést okozhat, ha meg nem előzik. A nem biztonságos eljárásokra is ez a jelzés figyelmeztet.



Veszélyes mértékű, nem szigetelt feszültség jelenléte figyelmezteti a felhasználót a hűtő házában. A feszültség nagysága elég jelentős ahhoz, hogy áramütés veszélyét jelentse.



Forró felületek okozta veszélyre figyelmeztet.



Azt jelzi, hogy el kell olvasni a használati utasítást.

Ne használja a berendezést steril vagy beteghez csatlakoztatott eszközként. Továbbá a berendezés nem használható a National Electrical Code szabvány által definiált I., II. vagy III. osztályú veszélyes helyen.

A berendezés csak beltérben használható. Ne helyezze a hűtőt olyan helyre, amelyet erős hő, nedvesség, elégtelen szellőzés vagy korrozív anyagok jelenléte jellemez. Az üzemi paraméterek megtalálhatók a kézikönyvben.

Csatlakoztassa a berendezést egy megfelelően földelt csatlakozóaljzathoz.

Az alkalmazott hűtőközegek nehezebbek a levegőnél, ezért szivárgás esetén kiszorítják az oxigént, ami eszméletvesztést okoz. A szivárgó hűtőközeg a bőrt érintkezve fagyást okoz. A hűtőközeg típusa fel van tüntetve a berendezés adattábláján, további információkat pedig a gyártó legfrissebb amerikai biztonsági adattábláján (SDS, korábbi nevén MSDS) vagy európai biztonsági adattábláján találhat.

A berendezés mozgathatóságkor legyen óvatos. A zökkenések vagy leejtés kárt tehet a berendezés komponenseiben. Mozgatás előtt mindig kapcsolja ki és válassza le az áramforrásról a berendezést.

Ne üzemeltesse a berendezést, ha az sérült vagy szivárog.

Ne használjon gyúlékony vagy korrozív folyadékokat. Csak a kézikönyvben szereplő, jóváhagyott folyadékokat használjon. Mielőtt bármilyen folyadékokat használna, illetve olyan karbantartást végezne, amely vármatóan folyadékkal való érintkezéssel jár, ismerkedjen meg a gyártó legfrissebb amerikai biztonsági adattábláján (SDS) vagy európai biztonsági adattábláján szereplő információkkal.

Mozgatás előtt mindig kapcsolja ki és válassza le az áramforrásról a berendezést.

A szervizelést és a javítást bízva képzett szakemberre.

A berendezést -25 és 60 °C közötti hőmérséklet (csomagolással) és 80% alatti relatív páratartalom mellett kell tárolni.

Az üzemem kívül helyezést csak szakkereskedő hajthatja végre, minősített berendezés használatával. Minden érvényben lévő előírást be kell tartani.

A telepítési, üzemeltetési, illetve karbantartási eljárásoknak a kézikönyvben foglalttól eltérő végrehajtása veszélyes helyzetet teremthet, és érvénytelené teszi a gyártó garanciáját.

A Polar hűtők nem szerelhetők padlóra. A hűtőket használat előtt 24 órán át tartsa álló helyzetben szobahőmérsékleten (~25 °C). A kenőolaj így vissza tud folyni a kompresszorba.

Soha ne vezessen hálózati feszültséget a hűtő kommunikációs csatlakozóba.

Ne használjon autópáni fagyállót. A kereskedelembe kapható fagyállókban található szilikátok kárt tesznek a szivattyú tömítéseiben.

EG/víz vagy PG/víz üzemi folyadék-keverék használata esetén rendszeres időközönként ellenőrizni kell a folyadék koncentrációját és pH-értékét. A koncentráció és a pH-érték változása befolyásolhatja a rendszer teljesítményét.

Inhibitoros EG vagy inhibitoros PG esetén ne használjon deionizáló (DI) szűrőbetétet. A DI-szűrő eltávolítja az oldatból az inhibitorokat, így a folyadék hatástalan lesz a korrózióvédelem szempontjából. Az inhibitorok emellett növelik a folyadék vezetőképességét.

A Polar hűtő szoftverét a használt üzemi folyadéknak megfelelően kell beállítani.

A biocidok és a korrozív anyagok visszafordíthatatlan szemkárosodást és a bőr égési sérülését okozhatják. Belélegezve, lenyelve és a bőrön át felszívódva is ártalmasak. További információkat a gyártó legfrissebb biztonsági adattáblája tartalmaz.

A kondenzátorszűrő tisztításának/cseréjének elmulasztása a hűtési kapacitás csökkenéséhez és a hűtőrendszer idő előtti meghibásodásához vezet.

Légműtő hűtők esetében az elülső rácscserelevény mögött található kondenzátor váza és bordázata nagyon éles.

Ne üzemeltesse a hűtőt eltávolított panelel.

Rendeltetészerű használat, recirkulációs hűtők:

A Thermo Scientific recirkulációs hűtői folyamatos, állandó hőmérsékletű és térfogatáramú folyadékellátás biztosítására szolgálnak. A hűtőt egy lég- vagy vízűtéses hűtőrendszer, egy hőcserélő, egy újrakeringető szivattyú, egy üzemi folyadék-tartály és egy mikroprocesszoros vezérlő alkotja.

A hűtők folyamatos beltéri üzemeltetésre szolgálnak a kézikönyvükben foglalt valamennyi eljárás és követelmény szem előtt tartásával.





Telepítés, recirkulációs hűtők:

Úgy helyezze el a hűtőt, hogy a megszakítója a közelében, könnyen hozzáférhető helyen legyen.

A berendezést kifejezetten erre a célra szolgáló aljzathoz kell csatlakoztatni.

Telepítés előtt távolítsa el valamennyi csővezeték szállítódugóit.

Polar hűtők esetében a csővezeték sérülésének megelőzése érdekében 19 mm-es racsnis kulccsal távolítsa el, illetve telepítse a külső csatlakozásokat.

Az üzemi folyadék csatlakozásai a hűtő hátulján találhatók  (PROCESS OUTLET – üzemi kimenet) és  (PROCESS INLET – üzemi bemenet) címkével. A  csatlakozóhoz csatlakoztassa a rendszer folyadékmenetét, a  csatlakozóhoz pedig a folyadékimenetét.

A hűtő elindítása előtt újból ellenőrizze az összes szükséges kommunikációs, elektromos és csővezeték-csatlakozást.



Pagrindinės saugos instrukcijos Recirkuliuojantys aušintuvai

Jei kurios nors iš šių instrukcijų yra nesuprantamos, prieš tęsdami skaitykite vadovą arba kreipkitės į mus.

Sauga, visi gaminiai:

⚠ DANGER nurodo neišvengiamai pavojingą situaciją, kurios neišvengus, galima mirties arba rimto sužalojimo baigtis.

⚠ WARNING nurodo galimai pavojingą situaciją, kurios neišvengus, galima mirties arba rimto sužalojimo baigtis.

⚠ CAUTION nurodo galimai pavojingą situaciją, kurios neišvengus, kyla nerimto arba vidutinio sužalojimo tikimybė. Taip pat galima pranešti, kai yra naudojama nesaugiai.

 skirta pranešti naudotojui, kai prie aušintuvo yra neizoliuota „pavojinga įtampa“. Įtampos dydis yra gana svarbus ir gali sukelti elektros šoko pavojų.

 nurodo esamus karštus paviršius.

 nurodo skaityti vadovą.

Nenaudokite įrangos kaip steriliaus ar prie paciento prijungto prietaiso. Be to, įranga nėra skirtas naudoti I, II ir III klasės pavojingose vietose, kaip nurodyta Nacionaliniame elektros kodekse.

Įranga yra sukurta tik naudoti viduje. Niekada nedėkite jo vietoje, kur yra per didelis karštis, drėgmė, neįtakamas vėdinimas arba korozinių medžiagų. Darbinių parametrų iškokite vadove.

Prijunkite įrangą prie tinkamai žeminto išvado.

Naudojami aušalai yra sunkesni nei oras ir, esant nutekėjimui, jie išstums deguonį, dėl ko galima prarasti sąmonę. Prisilietus prie ištekėjusių aušalų, galima nudegti odą. Naudojamo aušalo tipo ir gamintojo naujausios JAV saugumo duomenų išklotinės (SDS), anksčiau žinomos kaip MSDS bei ES saugumo duomenų išklotinės papildomos informacijos ieškote cirkulatoriaus techninių duomenų lentelės.

Įrangą perkeltite atsargiai. Staigus krestelėjimai arba kritimai gali pažeisti jos komponentus. Prieš perkeldami visuomet išjunkite įrangą ir atjunkite juo maitinimo įtampos.

Niekada nenaudokite pažeistos ar tekancios įrangos.

Niekada nenaudokite degių ar korozinių skysčių. Naudokite tik vadove išvardintus patvirtintus skysčius. Prieš pradėdami naudoti bet kokius skysčius ar atlikdami priežiūrą, kurios metu gali pasitaikyti kontaktų su skysčiais, papildomos informacijos ieškokite gamintojo naujausioje JAV saugumo informacijos išklotinėje (SDS) ir ES saugumo informacijos išklotinėje.

Prieš perkeldami visuomet išjunkite įrangą ir atjunkite juo maitinimo įtampos.

Aptarnavimo ir remonto kreipkitės į kvalifikuotą techniką.

Laikykite įrangą temperatūros intervale nuo -25 °C iki 60 °C (su įpakavimu) ir <80 % santykinėje drėgmėje.

Eksploatacijos nutraukimą turi atlikti tik kvalifikuotas pardavėjas, naudojantis sertifikuotą įrangą. Reikia laikytis visų galiojančių nuostatų.

Kitokių įrengimo, naudojimo ir priežiūros procedūrų nei nurodyta vadove gali sukelti pavojingą situaciją ir anuliuos gamintojo garantiją.

„Polar“ aušintuvai nėra skirti tvirtinimui prie grindų. Prieš įjungdami 24 valandoms palikite aušintuvus vertikaliaje padėtyje kambario temperatūroje (~25 °C). Taip sutepimo alyva suteka atgal į kompresorių. Niekada nejunkite linijos įtampos prie bet kurių komunikacinių jungčių aušintuve.

Nenaudokite automobilinio antifrizo. Komerčiuose antifrizuose yra silikatų, kurie pažeidžia siurblo sandarumą.

Naudodami darbinio skysčio EG / vandens arba PG / vandens mišinį, reguliariai tikrinkite skysčio koncentraciją ir pH. Koncentracijos ir pH pakitimai gali turėti įtakos sistemos veikimui.

Nenaudokite Dejonizacijos (DJ) filtro dėžutės su EG inhibitoriumi arba PG inhibitoriumi. DJ filtras pašalins inhibitorius iš mišinio ir padarys skysčio apsaugą nuo korozijos neefektyvia. Inhibitoriai taip pat didina specifinį skysčio laidumą.

„Polar“ aušintuvo programinė įranga turi būti sureguliuota, kad atitiktų naudojamą darbinį skystį.

Biocidai sukelti koroziją ir gali nepagydomai pažeisti akis ar nudeginti odą. Jie yra kenksmingi įkvėpus, nurijus ar įsisavinus per odą. Naujausios SDS kreipkitės į gamintoją.

Neišvalius / nepakeitus kondensatoriaus filtro gali sumažėti aušinimo apimtys ir tai gali baigtis pirmalaikiu vėsinimo sistemos gedimu.

Oru vėsinamuose aušintuvuose kondensatoriaus rėmas ir mentės, esantys už priekinių grotelių sąrankos, yra labai aštrūs.

Niekada nenaudokite aušintuvo su nuimtu skydeliu.

Numatytas naudojimas, Recirkuliuojantys aušintuvai:

„Thermo Scientific“ recirkuliuojantys aušintuvai yra sukurti tiekti nuolatinį kiekį tos pačios temperatūros ir tekėjimo srauto skysčio. Aušintuvą sudaro oru arba vandeniu vėsinama šaldymo sistema, šilumokaitis, recirkuliacinio siurblys, darbinio skysčio rezervuaras ir mikroprocesorinis valdiklis.

Aušintuvai yra sukurti nepertraukiamam veikimui ir tik naudojimui viduje pagal visas procedūras ir reikalavimus, išdėstytus šiame vadove.





Įrengimas, Recirkuliuojantys aušintuvai:

Pastatykite aušintuvą, kad jis būtų arti ir lengvai pasiekiamo atjungimo prietaiso.

Aušintuvą yra skirtas naudoti su atskiru išvadu.

Prieš įrengimą, užtikrinkite, kad visi kanalizacijos vamzdžio transportavimo kamščiai yra išimti.

Kad išvengtų „Polar“ aušintuvų kanalizacijos sugadinimo, naudokite 19 mm atraminį raktą išorinėms jungtims nuimti / uždėti.

Darbinio skysčio jungtys yra aušintuvo užpakalyje ir yra pažymėtos  (PROCESS OUTLET) (DARBINIS IŠVADAS) ir  (PROCESS INLET) (DARBINIS ĮVADAS). Prijunkite  prie skysčio įvado jūsų pritaikyme. Prijunkite  prie skysčio išvado jūsų pritaikyme.

Prieš paleisdami aušintuvą dar kartą patikrinkite visas galimas komunikacines, elektros ir kanalizacijos jungtis.



Būtikas drošības instrukcijas Recirkulācijas dzesētāji

Ja kāda no šīm instrukcijām nav saprotama, pirms turpināt darbu, skatiet rokasgrāmatu vai sazinieties ar mums.

Drošības apzīmējumi (attiecas uz visiem izstrādājumiem)



Norāda uz nopietnu apdraudējumu, kas var izraisīt nāvi vai nopietnas traumas, ja netiek novērsta.



Norāda uz potenciāli bīstamu situāciju, kas var izraisīt nāvi vai nopietnas traumas, ja netiek novērsta.



Norāda uz potenciāli bīstamu situāciju, kas var izraisīt vieglas vai mērenas traumas, ja netiek novērsta. Šis apzīmējums arī tiek izmantots, lai brīdinātu par nedrošu rīcību.



Brīdina lietotāju par neizolēta bīstama sprieguma klātbūtni dzesētāja korpusā. Spriegums ir pietiekami augsts, lai radītu elektrotiecienu gūšanas risku.



Norāda uz karstu virsmu klātbūtni.



Norādījums lasīt rokasgrāmatu.

Neizmantojiet aprīkojumu kā sterili vai ar pacientu saistītu ierīci. Turklāt aprīkojums nav paredzēts lietošanai I, II vai III klases bīstamās zonās atbilstoši ASV Nacionālās elektrotehnikas standartu sistēmas prasībām.

Aprīkojums ir paredzēts lietošanai tikai slēgtās telpās. To nekādā gadījumā nedrīkst novietot vietā, kur pastāv pārmerīga karstuma, mitruma vai korozīvu vielu klātbūtne, vai arī nav piemērota ventilācija. Eksploataācijas parametrus skatiet rokasgrāmatā.

Pieslēdziet aprīkojumu atbilstoši saņemtai kontaktklīdznāi.

Izmantoie aukstumāģenti ir smēķāki par gaisu un noplūdes gadījumā izspiedīs skābekli, izraisot samaņas zudumu. Nonākot saskarē ar noplūdušu aukstumāģentu, rodas ādas apdegumi. Izmantojamā aukstumāģenta veidu skatiet uz cirkulatora nominālvērtību plāksnītes, savukārt papildinformāciju skatiet jaunākajā ražotāja nodrošinātajā ASV drošības datu lapā (SDS) (kādreizējā MSDS), kā arī ES drošības datu lapā.

Pārvietojot aprīkojumu, ievērojiet piesardzību. Pēkšņi satricinājumi vai krišana var sabojāt tā sastāvdaļas. Pirms aprīkojuma pārvietošanas vienmēr to izslēdziet un atvienojiet no elektroapgādes tīkla.

Nekādā gadījumā nedarbiniet aprīkojumu, ja tas ir bojāts vai tam ir sūce.

Nekādā gadījumā nelietojiet viegli uzliesmojošus vai korozīvus šķīdumus. Izmantojiet tikai apstiprinātos šķīdumus, kas norādīti rokasgrāmatā. Pirms jebkāda šķīduma lietošanas vai tādu apkopes darbu veikšanas, kuru laikā iespējams nonākt saskarē ar šķīdrumu, skatiet papildinformāciju jaunākajās ražotāja nodrošinātajās ASV drošības datu lapās (SDS) un ES drošības datu lapās.

Pirms aprīkojuma pārvietošanas vienmēr to izslēdziet un atvienojiet no elektroapgādes tīkla.

Apkalpošanu un remontu drīkst veikt tikai atbilstoši kvalificēti tehniskie speciālisti.

Aprīkojums jāuzglabā temperatūras diapazonā no -25 °C līdz 60 °C (ar iepakojumu) un pie <80% relatīvā mitruma.

Izņemšanu no eksploatācijas drīkst veikt tikai attiecīgi kvalificēts izpildītājs, izmantojot sertificētu aprīkojumu. Ir jāievēro visu piemērojamo likumdošanas aktu prasības.

Ja tiek veikta uzstādīšanas, eksploatācijas vai apkopes procedūra, kas atšķiras no šajā rokasgrāmatā aprakstītajām, var rasties bīstamas situācijas, un tiek anulēta ražotāja garantija.

Polar dzesētāji nav paredzēti uzstādīšanai uz grīdas. Pirms iedarbināšanas recirkulācijas dzesētājiem jāatrodas vertikālā pozīcijā istabas temperatūrā (~25 °C) 24 stundu ilgumā. Tādējādi tiek nodrošināta eļļošanas eļļas atplūde kompresorā.

Nekādā gadījumā nepievienojiet līmijas spriegumu jebkādiem dzesētāja sakaru savienojumiem.

Nedrīkst lietot automobiļiem paredzētu antifrizu. Komerciāli pieejamais antifrizs satur silikātus, kas boja sūkņa bītvējumus.

Ja tehniskais šķīdums ir EG/ūdens vai PG/ūdens vai PG/ūdens maisījums, regulāri pārbaudiet šķīduma koncentrāciju un pH līmeni. Koncentrācijas un pH līmeņa izmaiņas var ietekmēt sistēmas veiktspēju.

Nelietojiet dejonizācijas (DI) filtra kasetni ar inhibētu EG vai inhibētu PG. DI filtrs atdalīs inhibitorus no šķīduma, padarot šķīdrumu neefektīvu aizsardzībai pret koroziju. Inhibitori arī palielina šķīduma vadītspēju. Polar dzesētāja programmatūra ir jāpielāgo atbilstoši izmantotajam tehniskajam šķīdrumam.

Biocīdi ir korozīvi un var izraisīt neatgriezeniskus acu bojājumus un ādas apdegumus. To iedarbība ir kaitīga, ja tie tiek ieelpoti, norīti vai absorbēti caur ādu. Skatiet jaunākās ražotāja nodrošinātās SDS.

Ja kondensatora filtrs netiek tīrīts/inomantīts, tiek izraisīts dzesēšanas kapacitātes zudums un priekšlaicīga dzesēšanas sistēmas atteice.

Dzesētājiem ar gaisa dzesēšanu kondensatora rāmis un ribas, kas atrodas aiz priekšējā režģa, ir ļoti asas. Nekādā gadījumā nedarbiniet dzesētāju, ja ir noņemts kāds panelis.

Recirkulācijas dzesētāju paredzētais lietojums

Thermo Scientific recirkulācijas dzesētāji ir paredzēti, lai nodrošinātu pastāvīgu šķidruma padevi ar konstantu temperatūru un plūsmas ātrumu. Dzesētājs sastāv no dzesēšanas sistēmas ar gaisu vai ūdens dzesēšanu, siltummaiņa, recirkulācijas sūkņa, tehniskā šķidrums rezervuāra un mikroprocesoru kontroltera.

Dzesētāji ir paredzēti pastāvīgai darbināšanai slēgtās telpās atbilstoši visām procedūrām un prasībām, kas norādītas šajā rokasgrāmatā.

Recirkulācijas dzesētāju uzstādīšana



Novietojiet dzesētāju, lai tas atrastos atvienošanas ierīces tuvumā un tā būtu viegli pieejama.

Dzesētājs ir paredzēts pievienošanai pie atsevišķas kontaktligzdas.

Nodrošiniet, lai pirms uzstādīšanas būtu noņemti visi transportēšanai paredzētie cauruļu aizgriežņi.

Lai neizraisītu Polar dzesētāju cauruļu savienojumu bojājumus, ārējo savienojumu demontāžai/uzstādīšanai izmantojiet 19 mm uzmaucamo atslēgu ar fiksatoru.

Tehniskā šķidrums savienojumi atrodas dzesētāja aizmugurē un ir apzīmēti kā  (PROCESS OUTLET) (DARBA ŠĶIDRUMA IZPLŪDE) un  (PROCESS INLET) (DARBA ŠĶIDRUMA IEPLŪDE).

Pievienojiet  ierīces šķidrums ieplūdes vietai. Pievienojiet  ierīces šķidrums izplūdes vietai.

Pirms dzesētāja iedarbināšanas vēlreiz pārbaudiet visus sakarus, elektriskos un cauruļu savienojumus.

Istruzzjonijiet Essenzjali tas-Sigurtà Recirculating Chillers

Jekk xi waħda minn dawn l-istruzzjonijiet ma tinfi hemx, irreferi għall-manwal jew ikkuntattja qabel ma tipproċedi.

Sigurtà: il-prodotti kollha:

DANGER jindika sitwazzjoni perikoluża b' mod imminenti, li jekk ma tiġix evitata, se tirriżulta f'mewt jew f'korrimient serju.

WARNING jindika sitwazzjoni potenzjalment perikoluża, li jekk ma tiġix evitata, tista' tirriżulta f'mewt jew f'korrimient serju.

CAUTION jindika sitwazzjoni potenzjalment perikoluża, li jekk ma tiġix evitata, tista' tirriżulta f'korrimient żgħir jew moderat. Jista' jintuża wkoll biex iwissi kontra prattici li mhumiex siguri.

 intenzjonat biex iwissi lill-utent dwar l-preżenza ta' "vultaġġ perikoluż" mhux insulat fl-enclosure ta' chiller. Il-qawwa tal-vultaġġ hi sinifikanti biżżejjed biex tikkostitwixxi riskju ta' xokk elettriku.

 jindika l-preżenza ta' wċuħ jaħraq.

 jindika biex dak li jkun jaqra l-manwal.

Tużax it-tagħmir bħala tagħmir sterili jew tagħmir li jiġi kkonnettjat mal-pazjent. Barra minn hekk, it-tagħmir mhux iex maħsub għall-użu f'Postijiet Perikolużi ta' Klassi I, li jiwiss lill-kif definit min-National Electrical Code. Dan it-tagħmir hu maħsub biex jintuża fuq ġewwa biss. Qatt tpoġġih f' post fejn ikun hemm shana eċċessiva, umdiċi, ventilażjoni inadegwata, jew materjali korrużivi. Irreferi għall-manwal għall-parametri tal-operat. Ikkonnettja t-tagħmir ma' outlet li jkun erjat kif support.

Ir-refrigerants użati huma itqal mill-arja u, jekk ikun hemm tniġġija, se jissostitwixxu l-oġġu u jikkawżaw li wieħed jimitief minn sensih. Kuntatt ma' refrigerant li jkun qed inixxi se jikkawża hruq tal-ġilda. Irreferi għas-circulator nameplate għat-tip ta' refrigerant użat u mbagħad għal US Safety Data Sheet (SDS) l-aktar riċenti tal-manifattur, li qabel kienet magħnufa bħala MSDS, u l-EU Safety Data Sheet għal informazzjoni addizzjonali.

Ċaqlaq it-tagħmir b'attenzjoni. Skossi għall-għarrieda jew li twaqqa' t-tagħmir, jistgħu jagħmlu ħsara lill-komponenti tiegħu. Dejjem ifti t-tagħmir u skonnettjah minn mal-provvista tad-dawl tiegħu qabel iċċaqliqu.

Qatt m'għandek tħaddem tagħmir bil-ħsara jew tagħmir li jkun qed inixxi.

Qatt m'għandek tuża fluwidu li jistgħu jjeħdu n-nar jew li huma korrużivi. Uża biss il-fluwidu approvati li huma elenkati fil-manwal. Qabel tuża kwalunkwe fluwidu jew twestaq manutenzjoni fejn x'aktarx se jkun hemm kuntatt mal-fluwidu, irreferi għal US Safety Data Sheet (SDS) l-aktar riċenti tal-manifattur, u l-EU Safety Data Sheet għal informazzjoni addizzjonali.

Dejjem ifti t-tagħmir u skonnettjah minn mal-provvista tad-dawl tiegħu qabel iċċaqliqu.

Irreferi s-service u t-fiswijiet lill-technician ikkwalifikat.

Aħżen it-tagħmir f' medda ta' temperatura ta' -25°C sa 60°C (bl-ippakkjar), u umdiċi relattiva ta' <80%.

Id-dekmissionar irid isir biss minn agent ikkwalifikat bl-użu ta' tagħmir iċċertifikat. Ir-regolamenti prevalenti kollha jridu jiġu segwiti.

Il-prestazzjoni tal-proċeduri tal-installazzjoni, operat, jew manutenzjoni, h'leif dawk deskritti fil-manwal, jistgħu jirriżultaw f' sitwazzjoni perikoluża, u dan se jħassar il-garanzija tal-manifattur.

Il-polar chillers mhumiex maħsuba biex jifwafħu ma-art. Ftali ċ-chillers f'pożizzjoni wieqfa fit-temperatura tal-kamra (~25°C) għal 24 siegħa qabel ma tiġi għelhom. Dan jzğura li z-żejt tal-lubrikazzjoni jkun mar lura fil-kompressor.

Qatt m'għandek tapplika line voltage lli xi waħda mill-konnessjonijiet tal-komunikazzjoni fuq iċ-chiller.

Tużax antifreeze tal-karozzi. Antifreeze kummerċjali fih silicates li jagħmlu ħsara lis-siġilli tal-pompa.

Meta tuża taħlita ta' fluwidu tal-process ta' EG/filma jew PG/filma, iċċekkja l-koncentrazzjoni tal-fluwidu u l-pH fuq bażi regolari. Bidliet fil-koncentrazzjoni u l-pH jista' jkollhom impatt fuq il-prestazzjoni tas-sistema.

Tużax Deionization (DI) filter cartridge b'Inhibited EG jew Inhibited PG. DI filter se jneħhi l-inibituri mis-soluzzjoni u dan jagħmel il-fluwidu mhux effettiv kontra l-protezzjoni mill-korrużjoni. Ukoll, l-inibituri jzidu l-konduktività tal-fluwidu.

Is-ftware tal-polar chiller irid jiġi aġġustat biex ikun jaqbel mal-process fluid li jkun qed jintuża.

Il-bijocidi huma korrużivi u jistgħu jikkawżaw ħsara iriversibbli fl-għajnejn u hruq tal-ġilda. Dawn huma perikolużi jekk jingibdu man-nifs, jinbelgħu jew jiġu assorbiti mill-ġilda. Irreferi għall-SDS l-aktar riċenti tal-manifattur.

Li ma tnaaddax/tibdix il-condenser filter, se jikkawża telf tal-kapaċità ta' tkessi u jwassal għal ħsara prematura tas-sistema ta' tkessi.

Fuq air-cooled chillers, il-condenser framing u fins li jinsabu wara l-front grill assembly, jaqgħu haġna.

Qatt m'għandek tħaddem iċ-chiller bi kwalunkwe panel imneħhi.

Użu Intenzjonat, Recirculating Chillers:

Thermo Scientific recirculating chillers huma maħsuba biex jipprovdu provvista kontinwa ta' fluwidu b'rata kostanti ta' temperatura u fluss. Iċ-chiller jikkonsisti minn sistema ta' refrigerazzjoni mkessha bl-arja jew mkessha bl-ilma, recirculating pump, process fluid reservoir u microprocessor controller.

Iċ-chillers huma maħsuba biex jaħdmu l-hin kollu u biex jintużaw fuq gewwa, skont il-proċeduri u r-rekwiziti kollha deskritti fil-manwali tagħhom.



Installazzjoni, Recirculating Chillers:

Pogġi ċ-chiller b'tali mod li jkun qrib, u jkun hemm access faċli, għat-tagħmir ta' skonnettjar tiegħu.

Iċ-chiller hu maħsub għall-użu fuq dedicated outlet.

Kun żgur li l-plumbing line shipping plugs jitneħħew kollha qabel l-installazzjoni.

Għal Polar chillers, biex tipprevjeni li tagħmel ħsara lill-plumbing taċ-chillers, uża 19 mm backing wrench meta tneħħi/tinstalla l-konnessjonijiet esterni.

Il-konnessjonijiet tal-process fluid jinsabu fuq in-naħa ta' wara taċ-chiller u huma tikkettati  (PROCESS OUTLET) u  (PROCESS INLET). Ikkonnettja l- ma-fluid inlet fuq l-applikazzjoni tiegħek. Ikkonnettja l- ma-fluid outlet fuq l-applikazzjoni tiegħek.

Qabel ma tistartja ċ-chiller, erga' ċċekkja l-konnessjonijiet tal-komunikazzjoni, tal-elettriku u tal-plumbing applikabbi kollha.

PL

Ważne instrukcje dotyczące bezpieczeństwa Chłodziarki recyrkulacyjne

W przypadku niezrozumienia którychkolwiek z niniejszych instrukcji, przed przystąpieniem do dalszych prac należy zapoznać się z instrukcją obsługi lub skontaktować się z nami.

Bezpieczeństwo, wszystkie produkty:

 wskazuje na sytuację bezpośredniego zagrożenia, która bez podjęcia środków zaradczych doprowadzi do śmierci lub poważnych obrażeń ciała.

 wskazuje na sytuację potencjalnie niebezpieczną, która bez podjęcia środków zaradczych może doprowadzić do śmierci lub poważnych obrażeń ciała.

 wskazuje na sytuację potencjalnie niebezpieczną, która bez podjęcia środków zaradczych doprowadzi do drobnych lub umiarkowanych obrażeń ciała. Ponadto będzie wykorzystywana do zgłaszania niebezpiecznych zachowań.

 ostrzega użytkownika o nieizolowanym "niebezpiecznym napięciu" w obrębie obudowy chłodziarki. Wartość bezwzględna napięcia jest na tyle wysoka, by nieść za sobą ryzyko porażenia prądem elektrycznym.

 ostrzega przed gorącymi powierzchniami.

 nakazuje przeczytać instrukcję obsługi.

Nie używać sprzętu, jako urządzenia sterylnego ani mającego kontakt z pacjentem. Ponadto sprzęt nie jest przeznaczony do zastosowań w obrębie Lokalizacji Niebezpiecznych, Klasy I, II lub III określonych przez Krajowe Normy Elektryczne.

Sprzęt został stworzony wyłącznie do użytku wewnątrz pomieszczeń. Nigdy nie należy go umieszczać w miejscu, gdzie wystawiony będzie na działanie zbyt wysokich temperatur, wilgoci, materiałów powodujących korozję lub w lokalizacjach o nieodpowiedniej wentylacji. Aby zapoznać się z parametrami roboczymi, patrz instrukcja obsługi.

Sprzęt podłączyć do odpowiednio uziemionego gniazdka.

Wykorzystywane czynniki chłodnicze są cięższe od powietrza, dlatego w przypadku nieszczelności zastąpią tlen, co doprowadzi do utraty przytomności. Kontakt z wyciekającym czynnikiem chłodniczym doprowadzi do poparzeń skóry. Aby uzyskać więcej informacji, patrz tabliczka znamionowa cyrkulatora, na której oznaczono typ wykorzystywanego czynnika chłodniczego, najnowsza karta charakterystyki substancji

niebezpiecznej US (SDS) producenta wcześniej znana jako MSDS, a także karta charakterystyki substancji niebezpiecznej EU.

Podczas transportowania sprzętu niezbędne jest zachowanie należytej ostrożności. Nagle wstrząsy lub upadek mogą skutkować uszkodzeniem podzespołów. Przed przystąpieniem do transportowania sprzętu należy pamiętać o jego wyłączeniu oraz odłączeniu od napięcia zasilającego.

Nigdy nie obsługiwać uszkodzonego lub nieszczelnego sprzętu.

Nigdy nie stosować płynów palnych lub powodujących korozję. Korzystać wyłącznie z zatwierdzonych płynów wymienionych w instrukcji obsługi. Przed użyciem jakiegokolwiek płynu lub przystąpieniem do jakichkolwiek prac konserwacyjnych, gdy prawdopodobny jest kontakt z płynem patrz najnowsza karta charakterystyki substancji niebezpiecznej US (SDS), a także karta charakterystyki substancji niebezpiecznej EU.

Przed przystąpieniem do transportowania sprzętu należy pamiętać o jego wyłączeniu oraz odłączeniu od napięcia zasilającego.

Prace serwisowe oraz naprawcze należy zlecić wykwalifikowanemu technikowi.

Sprzęt należy przechowywać w temperaturach -25°C do 60°C (w opakowaniu) oraz przy zachowaniu $<80\%$ wilgotności względnej.

Wycofanie z eksploatacji może zostać przeprowadzone wyłącznie przez wykwalifikowanego sprzedawcę wykorzystującego sprzęt posiadający niezbędne atesty. Niezbędne jest przestrzeganie wszystkich obowiązujących przepisów.

Wykonywanie czynności montażowych, konserwacyjnych lub obsługa odbiegająca od wytycznych opisanych w instrukcji obsługi może skutkować niebezpiecznymi sytuacjami oraz utratą gwarancji producenta.

Chłodziarki Polar nie zostały stworzone z myślą o montażu podłogowym. Przed uruchomieniem, chłodziarki pozostawić w pozycji pionowej w temperaturze pokojowej ($\sim 25^{\circ}\text{C}$) przez okres 24 godzin. Dzięki temu olej smarny spłynie z powrotem do sprężarki.

Nigdy nie stosować napięcia międzyprzewodowego na żadnym ze złączy komunikacyjnych chłodziarki.

Nie stosować samodosadowych płynów zapobiegających zamarzaniu. Komercyjne środki zapobiegające zamarzaniu zawierają krzemiany uszkadzające uszczelnienie pompy.

W przypadku wykorzystywania mieszaniny mediów chłodzących tj. EG/woda lub PG/woda należy regularnie sprawdzać zarówno stężenie płynu, jak i pH. Zmiany stężenia i pH mogą wpłynąć na wydajność układu.

Nie należy stosować wkładu filtra dejonizacyjnego (DI) ze stabilizowanym EG lub PG. Filtr DI usunie inhibitory z roztworu przez co płyn nie będzie zapewniał ochrony przeciwkorozyjnej. Ponadto, inhibitory zwiększają przewodność płynu.

Niezbędne jest odpowiednie skonfigurowanie oprogramowania chłodziarek Polar w celu zapewnienia kompatybilności z płynem procesu.

Biocydy posiadają właściwości korozyjne i mogą doprowadzić do nieodwracalnego uszkodzenia oczu bądź poparzeń skóry. Wdychanie, pokłnięcie lub wchłonięcie przez skórę jest szkodliwe dla zdrowia. Patrz najnowsza charakterystyka substancji niebezpiecznej producenta.

Zaniechanie czyszczenia/wymian filtra kondensatora doprowadzi do spadku wydajności chłodniczej oraz przedwczesnej awarii układu chłodzenia.

W przypadku chłodziarek chłodzonych powietrzem, obramowanie kondensatora oraz żeberka znajdujące się za przednim okratowaniem mają bardzo ostre krawędzie.

Podczas pracy wszystkie panele powinny znajdować się na swoich miejscach.

Przeznaczenie, Chłodziarki recyrkulacyjne:

Chłodziarki recyrkulacyjne Thermo Scientific zostały stworzone z myślą o ciągłym dostarczaniu płynu o stałej temperaturze i stałym tempie przepływu. Chłodziarka składa się z układu chłodzenia powietrzem lub wodą, wymiennika ciepła, pompy recyrkulacyjnej, zbiornika na płyn chłodniczy oraz sterownika mikroprocesorowego.

Chłodziarki zostały zaprojektowane do pracy ciągłej oraz do użytku w pomieszczeniach zgodnie ze wszystkimi procedurami i wymogami określonymi w ich instrukcjach obsługi.

Instalacja, Chłodziarki recyrkulacyjne:

Chłodziarkę należy umieścić w pobliżu jej urządzenia wyłączającego pamiętając o zapewnieniu do niego łatwego dostępu.

Chłodziarkę należy podłączyć do przeznaczonego dla niej gniazdka.

Zadbać o to, aby przed instalacją zdemontowane zostały wszystkie zaślepki przewodów wodociagowych założone na czas transportu.

W przypadku chłodziarek Polar, aby zapobiec uszkodzeniu instalacji wodociagowej chłodziarki podczas zdejmowania/montowania złączy zewnętrznych należy używać 19 mm klucza nakładkowego.

Złącza płynu chłodniczego znajdują się w tylnej części chłodziarki i zostały odpowiednio oznaczone etykietami  (PROCESS OUTLET - wylot) oraz  (PROCESS INLET - wlot). Podłączyć do wlotu płynu po stronie zastosowania. Podłączyć  do wylotu płynu po stronie zastosowania.

Przed uruchomieniem chłodziarki należy ponownie sprawdzić wszystkie połączenia oraz złącza elektryczne i wodociagowe.

RO

Instrucțiuni Esențiale de Siguranță Aparate frigorifice de recirculate

Consultați manualul sau contactați-ne înainte de a merge mai departe dacă oricare dintre aceste instrucțiuni sunt pe deplin înțelese.

Siguranță, toate produsele:

 indică o situație periculoasă iminentă care, în cazul în care nu se evită, poate cauza moarte sau vătămare corporală gravă.

 indică o situație potențial periculoasă care dacă nu se evită poate cauza moartea sau rănirea gravă.

 indică o situație potențial periculoasă care dacă nu se evită poate cauza răni minore sau moderate. Se folosește și pentru a atenționa împotriva practicilor periculoase.

 menit să atenționeze utilizatorul cu privire la prezența „voltajului periculos” neizolat din incinta aparatului frigorific. Magnitudinea voltajului este destul de mare pentru prezenta risc de șoc electric.

 indică prezenta suprafețelor încinse.

 indică citirea manualului.

Nu folosiți echipamentul ca dispozitiv steril sau dispozitiv conectat la pacient. În plus, echipamentul nu este conceput pentru a se folosi în Locuri Periculoase din Clasele I, II sau III conform definițiilor Codului Electric Național.

Echipamentul este conceput doar pentru uz intern. Nu se plasează niciodată în locuri sau unde se află niveluri crescute de căldură, umezeală sau substanțe corozive. Consultați manualul de utilizare pentru parametrii operaționali.

Conectați echipamentul la o priză împământată corespunzător.

Agenții frigorifici folosiți sunt mai grei decât aerului, iar dacă există o scurgere ei vor înlocui oxigenul și vor cauza pierderi de conștiență. Contactul cu scurgerile de agent frigorific poate cauza ardere la nivelul pielii. Consultați plăcuța de identificare a propagatorului pentru tipul de agent frigorific folosit și apoi cea mai actuală Fișă cu Date de Siguranță SUA(FDS) a producătorului cunoscută drept MSDS și Fișa cu Date de Siguranță UE pentru informații suplimentare.

Echipamentul se transportă cu grijă. Zguduielile sau căderile pot avaria componentele. Înainte de a-l transporta opriți mereu echipamentul și deconectați-l de la tensiunea de alimentare.

Nu operați niciodată echipament avariat sau care prezintă scurgeri.

Nu folosiți niciodată lichide inflamabile sau corozive. Folosiți numai lichidele aprobate care sunt enumerate în manual. Consultați cea mai actuală Fișă cu Date de Siguranță SUA (FDS) și Fișa cu Date de Siguranță UE pentru informații suplimentare înainte de folosi orice lichid sau de a efectua lucrări de întreținere când există șansa de a intra în contact cu lichide.

Înainte de a-l transporta opriți mereu echipamentul și deconectați-l de la tensiunea de alimentare.

Reparațiile și întreținerea se efectuează de către tehnicienii calificați.

Echipamentul se depozitează la temperaturi afite între -25°C to 60°C (cu ambalaj) și <80% umiditate relativă.

Retragerea din funcționare se efectuează numai de către un furnizor calificat folosind echipament certificat. Trebuie să se respecte toate prevederile curente.

Performanța instalației, operarea sau procedurile de întreținere pe lângă cele descrise în manual pot să cauzeze situații periculoase sau se anuleze garanția producătorului.

Aparatele frigorifice Polar nu sunt concepute pentru a se monta la sol. Aparatele frigorifice se lasă în poziție verticală la temperatura camerei (~25°C) pentru 24 de ore înainte de a se porni. Acest lucru asigură scurgerea înapoi în compresor a uleiului de lubrifiere.

Niciodată să nu aplicați tensiune de linie la conexiunile de comunicare ale aparatului frigorific.

Nu folosiți antigel pentru automobile. Antigelul comercial conține silicați care pot avaria izolația pompei.

Când se folosește un ameste de lichid de procesare cu apă/EG sau apă/PG se verifică regulat concentrația lichidului și a pH-ului. Schimbările concentrației și a Ph-ului afectează randamentul instalației.

Nu folosiți cartuş de filtrare deionizant cu EG Inhibat sau PG Inhibat. Filtrul deionizant va îndepărta inhibitorii din soluție, iar lichidul nu va avea niciun efect de protecție împotriva coroziunii. De asemenea, inhibitorii vor mări conductivitatea lichidului.

Softul aparatului de răcire Polar trebuie să se ajusteze corespunzător lichidului de procesare folosit.

Biocidul au efect coroziv și pot cauza răni ireversibile la nivelul ochilor și arsuri de piele. Sunt toxice dacă se inhalează, dacă se înghit sau dacă se absorb prin piele. Consultați cea mai recentă Fișă cu Date de Siguranță de la producător.

Dacă nu se curăță/înlocuiește filtrul de condensare se poate ajunge la scăderea capacității de răcire și la erori premature ale sistemului de răcire.

La aparatele frigorifice răcite cu aer, cadrul și muchiile de condens din spatele griaului frontal sunt foarte ascuțite.

Nu operați aparatul frigorific dacă panourile sunt îndepărtate.

Scop de utilizare, Aparate frigorifice cu Recirculare:

Aparatele frigorifice Thermo Scientific sunt concepute pentru a asigura alimentarea continuă cu lichid la temperatură și rată de curgere constantă. Aparatul frigorific este alcătuit din sistem frigorific răcit cu aer sau cu apă, un schimbător de căldură, pompă de recirculare, rezervor pentru lichid de procesare și un controler cu microprocesor.

Aparatele frigorifice sunt concepute pentru operare continuă și pentru uz intern conform tuturor procedurilor și condițiilor prevăzute în manualul lor.



Instalare, Aparat frigorific cu recirculare:

Plasați aparatul frigorific în așa fel încât să fie aproape și să aibă acces ușor la aparatul de deconectare.

Aparatul frigorific este conceput pentru a se folosi la o priză dedicată.

Asigurați-vă că toate toate mufele de transport de la linia de instalație s-au îndepărtat înainte de instalare.

Pentru a preveni avanile în cazul aparatelor frigorifice Polar se folosește o contracheie inelară de 19 mm pentru a se îndepărta/instala conexiunile externe.

Conexiunile pentru lichid de procesare se găsesc pe latura din spate a aparatului de răcire și sunt etichetate  (PROCESS OUTLET) (EVACUARE PROCES) și  (PROCESS INLET) (ADMISIE PROCES). Conectați  la admisia de lichid de la aplicația dumneavoastră. Conectați  la evacuarea de lichid de la aplicația dumneavoastră.

Înainte să porniți aparatul frigorific verificați de două ori comunicarea aplicabilă, conexiunile electrice și conexiunile de la instalație.



Základné bezpečnostné pokyny Recirkulačné chladiace jednotky

Ak nerozumiete niektorému z týchto pokynov, pred pokračovaním si prečítajte príručku alebo nás kontaktujte.

Bezpečnosť, všetky produkty:

 označuje bezprostredne nebezpečnú situáciu, ktorá, ak sa jej nevyhnete, spôsobí usmrtenie alebo vážne poranenie.

 označuje potenciálne nebezpečnú situáciu, ktorá, ak sa jej nevyhnete, môže spôsobiť usmrtenie alebo vážne poranenie.

 označuje potenciálne nebezpečnú situáciu, ktorá, ak sa jej nevyhnete, môže spôsobiť ľahké alebo stredne ťažké poranenie. Používa sa aj ako varovanie pred nebezpečnými postupmi.

 slúži na upozornenie používateľa na prítomnosť neizolovaného „nebezpečného napätia“ pod krytom chladiacej jednotky. Napätie je dostatočne vysoké na to, aby predstavovalo riziko úrazu elektrickým prúdom.

 označuje prítomnosť horúcich povrchov.

 označuje nutnosť prečítania príručky.

Zariadenie nepoužívajte ako sterilné alebo ako zariadenie pripojené k pacientovi. Zariadenie okrem toho nie je určené na použitie v nebezpečných prostrediach triedy I, II alebo III definovaných kódom NEC (National Electrical Code).

Zariadenie je určené len na použitie v interiéri. Nikdy ho neumiestňujte na mieste, kde je prítomné nadmerné teplo, vlhkosť, nedostatočné vetranie alebo korozívne materiály. Prečítajte si prevádzkové parametre uvedené v príručke.

Zariadenie pripojte k správne uzmerenej zásuvke.

Použitie chladivá sú ťažšie ako vzduch a ak odíde k úniku, nahradia kyslík a spôsobia stratu vedomia.

Kontakt s unikajúcim chladivom môže spôsobiť popálenie pokožky. Typ použitého chladiwa nájdete na typovom štítku obehového čerpadla a ďalšie informácie nájdete v poslednej karte bezpečnostných údajov (KBÚ) pre USA, predtým známej ako MSDS a karte bezpečnostných údajov pre EÚ.

Zariadenie presúvajte opatrne. Náhle otrasy alebo pády môžu poškodiť jeho komponenty. Pred každým presúvaním vypnite zariadenie a odpojte ho od napájacieho napätia.

Nikdy nepoužívajte poškodené alebo netesné zariadenie.

Nikdy nepoužívajte horľavé alebo korozívne kvapaliny. Používajte iba schválené kvapaliny uvedené v návode na použitie. Pred použitím akejkoľvek kvapaliny alebo vykonaním údržby, kde je pravdepodobný kontakt s kvapalinou, si prečítajte poslednú kartu bezpečnostných údajov (KBÚ) pre USA a kartu bezpečnostných údajov pre EÚ, v ktorých nájdete ďalšie informácie.

Pred každým presúvaním vypnite zariadenie a odpojte ho od napájacieho napätia.

Servis a opravy prenehajte kvalifikovanému technikovi.

Zariadenie skladujte pri teplotách -25°C až 60°C (s obalom) a pri relatívnej vlhkosti $<80\%$.

Vyradenie z prevádzky môže vykonať len oprávnený predajca pomocou certifikovaného vybavenia. Je nutné dodržiavať všetky platné zákonné ustanovenia.

Vykonanie inštalácie, prevádzky alebo postupov údržby, ktoré nie sú popísané v tomto návode, môže viesť k nebezpečným situáciám a bude viesť k zrušeniu platnosti záruky výrobcu.

Chladiace jednotky Polar nie sú navrhnuté na montáž na podlahe. 24 hodín pred spustením nechajte chladiacu jednotku vo zvislej polohe pri izbovej teplote (-25°C). Tým sa zaistí, že mazací olej sa preleje späť do kompresora.

Nikdy nepripájajte sieťové napätie k niektorému z komunikačných pripojení na chladiacej jednotke.

Nepoužívajte automobilovú nemrznúcu kvapalinu. Komerčné nemrznúce zmesi obsahujú silikáty, ktoré poškodzujú tesnenia čerpadla.

Pri použití zmesi procesnej kvapaliny EG/voda alebo PG/voda v pravidelných intervaloch kontrolujte koncentráciu kvapaliny a pH. Zmeny v koncentrácii a pH môžu mať vplyv na výkon systému.

Nepoužívajte deionizačné (DI) filtračné vložky s inhibovanou EG alebo inhibovanou PG. Filter DI odstráni inhibitory z roztoku a spôsobí, že bude mať kvapalina neúčinnú protikoroziu ochranu. Inhibitory tiež zvyšujú vodivosť kvapaliny.

Softvér chladiacej jednotky Polar musí byť upravený tak, aby bol v súlade s použitou procesnou kvapalinou.

Biocidy sú korozívne a môžu spôsobiť nevratné poškodenie očí a popálenie pokožky. Sú škodlivé pri vdýchnutí, požití alebo pri absorpcii cez pokožku. Prečítajte si poslednú KBÚ výrobcu.

Ak nevyčistíte/nevymeníte filter kondenzátora, dôjde k strate chladiaceho výkonu a k predčasnému zlyhaniu chladiaceho systému.

Na vzduchom chladených chladiacich jednotkách sú rámy a lopatky umiestnené za zostavou prednej mriežky veľmi ostré.

Neprevádzkujte chladiace jednotky, ak je odstránený akykoľvek panel.

Určené použitie, recirkulačné chladiace jednotky:

Recirkulačné chladiace jednotky Thermo Scientific sú navrhnuté na nepretržitú dodávku kvapaliny pri konštantnej teplote a prietoku. Chladiaca jednotka pozostáva z chladiaceho systému alebo vzduchom chladeného alebo vodou chladeného výmenníka tepla, recirkulačného čerpadla, nádrže na procesnú kvapalinu a mikroprocesorového regulátora.

Chladiace jednotky sú určené na nepretržitú prevádzku a na vnútorné použitie v súlade so všetkými postupmi a požiadavkami uvedenými v príslušnom návode na použitie.

Inštalácia, recirkulačné chladiace jednotky:

Chladiacu jednotku umiestnite tak, aby bola blízko odpájacieho zariadenia, aby bol k nemu ľahký prístup.

Chladiaca jednotka je určená na pripojenie k vyhradenej zásuvke.

Uistite sa, že sú pred inštaláciou odstránené všetky prepravné zátky inštalátorských potrubí.

V prípade chladiacich jednotiek Polar pri demontáži/montáži externých pripojení použite 19 mm podporný kľúč, aby nedošlo k poškodeniu potrubia chladiacej jednotky.

Pripojky pre procesnú kvapalinu sú umiestnené na zadnej strane chladiacej jednotky a sú označené ako  (PROCESS OUTLET) (PROCESNÝ VÝSTUP) a  (PROCESS INLET) (PROCESNÝ VSTUP). Pripojte  k vstupu kvapaliny na vašej aplikácii. Pripojte  k výstupu kvapaliny na vašej aplikácii.

Pred spustením chladiacej jednotky dvakrát skontrolujte všetky príslušné komunikačné, elektrické a vodovodné pripojky.

SL

Osnovna varnostna navodila Recirkulacijski ohlajevalniki

Če ne razumete kategorikoli navodila, si pogledajte navodila za uporabo ali stopite v stik z nami, še preden nadaljujete.

Varnost - vsi izdelki:

 Opozarja na akutne nevarne okoliščine, ki lahko – če se jim ne izognete – povzročijo resne ali celo smrtne nevarne poškodbe.

 Opozarja na morebitno nevarne okoliščine, ki lahko – če se jim ne izognete – povzročijo resne ali celo smrtne nevarne poškodbe.

 Opozarja na akutne nevarne okoliščine, ki lahko – če se jim ne izognete – povzročijo lažje ali srednje nevarne poškodbe. Uporablja se tudi kot opozorilo proti nevarni praksi.

 opozarja na bližino neizolirane nevarne napetosti v ohišju ohlajevalnika. Napetost je dovolj visoka, da lahko povzroči električni šok.

 opozarja na vroče površine.

 opozarja, da je potrebno prebrati navodila.

Ne uporabljajte aparata kot sterilno napravo, ali napravo, povezane z bolnikom. Poleg tega naprava ni načrtovana za uporabo v napravah, ki delujejo v nevarnih okoljih I., II. in III. razreda po določenih Nacionalnega pravilnika za električne naprave.

Naprava je načrtovana za uporabo v zaprtih prostorih. Nikoli ne postavite naprave na mesto z visoko temperaturo, vlago, nezadostnim prezračevanjem in jedrkimi snovmi. Delovni parametri so navedeni v navodilih.

Priključite napravo v pravilno ozemljeno vtičnico.

Uporabljena hladilna sredstva so težja od zraka. Če obstajajo netesna mesta, bodo izpodrinila kisik in povzročila izgubo zavesti. Stik z uhajajočim hladilnim sredstvom bo povzročil ozeblino. Dodatne informacije boste našli na cirkulatorjevi plošči s podatki, na kateri je naveden tip hladilnega sredstva, najnovjšem varnostnem listu za ZDA (SDS), ki je bil prej poznan pod nazivom MSDS in varnostnem listu za EU.

Previdno premikajte opremo. Nenadni sunki ali padci lahko poškodujejo njene dele. Preden premikate opremo, jo vedno izklopite in odklopite z omrežnega napajanja.

Nikoli ne delajte z opremo, ki je poškodovana ali pušča.

Nikoli ne uporabljajte vnetljivih ali jedkih tekočin. Uporabite le odobrene tekočine, navedene v predmetnih navodilih za uporabo. Preden uporabite katerikoli tekočino ali opravite vzdrževanje, pri katerem je vključen stik s tekočino pregledajte najnovjši varnostni list ZDA (SDS) in varnostni listu EU, kjer bosta naši podrobnejše informacije.

Preden premikate opremo, jo vedno izklopite in odklopite z omrežnega napajanja.

Servis in popravila lahko izvaja le ustrezno usposobljen tehnik

Shranite opremo pri temperaturi med -25 °C in 60 °C (z embalažo) in relativno zračno vlago <80 %.

Razgradnjo naprave lahko opravi le ustrezno usposobljen zastopnik, ki uporablja odobreno opremo.

Uporabljajte vse veljavne zadevne predpise.

Izvajanje kakršnihkoli postopkov, povezanih z montažo, delovanjem ali vzdrževanjem, ki niso navedeni v teh navodilih, lahko povzroči nevarne okoliščine in izniči veljavnost garancije proizvajalca.

Ohlajevalniki Polar niso načrtovani za namestitvev na tla. Ohlajevalniki morajo v pokončnem položaju pri sobni temperaturi (~25 °C) mirovati 24 ur pred začetkom obratovanja. Slednje zagotavlja, da olje za mazanje odteče nazaj v kompresor.

Nikoli ne priključite omrežne napetosti na katerikoli komunikacijski priključek ohlajevalnika.

Ne uporabljajte avtomobilskega antifriz. Antifriz iz redne prodaje vsebujejo silikate, ki lahko poškodujejo tesnila črpalke.

Če uporabljate procesno tekočino EG/voda ali PG/voda, redno preverjajte koncentracijo in pH tekočine. Spremembe koncentracije in pH lahko vplivajo na zmogljivost sistema.

Ne uporabite kartuše deionizacijskega (DI) filtra z inhibiranim EG ali PG. Filter DI bo odstranil inhibitorje iz raztopine, kar pomeni, da tekočina ne bo več ščitila pred korozijo. Inhibitorji poleg tega povečajo prevodnost tekočine.

Programska oprema ohlajevalnika Polar mora biti nastavljena, da ustreza uporabljeni procesni tekočini.

Biocidi so korozivni in lahko nepopravljivo poškodujejo oči in povzročijo kožne opekline. Škodijo pri vdihavanju, zaužiju ali absorpciji skozi kožo. Preverite proizvajalčev najnovjši SDS.

Če ne očistite/zamenjate filtra kondenzatorja, lahko slednje povzroči zmanjšanje hladilne zmogljivosti in predčasno odpoved hladilnega sistema.

Pri zračno hlajenih ohlajevalnikih so okvir in lamele, ki se nahajajo za prednjo rešetko zelo ostri.

Nikoli ne uporabljajte ohlajevalnika, če je odstranjen katerikoli panel.

Namenska uporaba, recirkulacijski ohlajevalniki:

Recirkulacijski ohlajevalniki Thermo Scientific so načrtovani za nenehen dovod tekočine z enekomerno temperaturo in pretokom. Ohlajevalnik je sestavljen iz zračno ali vodno hlajenega hladilnega sistema, toplotnega izmenjevalnika, obtočne črpalke, rezervoarjem procesirane tekočine

Ohlajevalniki so načrtovani za neprekinjeno obratovanje v zaprtih prostorih v skladu z vsemi postopki in zahtevami, navedenimi v tem priročniku.

Namestitev, ohlajevalnik z recirkulacijo:

Namestite ohlajevalnik v bližino, da imate enostaven dostop do odklopne naprave.

Ohlajevalnik je namenjen za uporabo na posebni vtičnici.

Pred montažo preverite, ali so z vseh cevi odstranjeni transportni čepi.

Zaradi preprečevanja poškodb na krogotoku ohlajevalnika, uporabite pri namestitvi/odstranjevanju zunanjih priključkov dodatni držalni ključ 19 mm.

Procesne povezave za tekočino se nahajajo na zadnji strani ohlajevalnika in so ustrezno označene

 PROCESS OUTLET (PROCESNA VTIČNICA) in  PROCESS INLET (PROCESNI DOVOD).
Priključite  na vhod za tekočino vaše aplikacije. Priključite  na dovod za tekočino vaše aplikacije.

Pred vklopom ohlajevalnika dvakrat preverite vse razpoložljive komunikacije ter električne in vodovodne povezave.

Osnovna bezbednosna uputstva Cirkulirajući rashladni uređaji

Ako ne razumete bilo koja od ovih uputstava, pogledajte priručnik ili nas kontaktirajte pre nego što nastavite.

Bezbednost, svi proizvođači:

 označava neposrednu opasnost koja, ako se ne izbegne, će da dovede do smrti ili teške povrede.

 označava potencijalno opasnu situaciju koja, ako se ne izbegne, može da dovede do smrti ili teške povrede.

 označava potencijalno opasnu situaciju koja, ako se ne izbegne, može da dovede do lakše ili srednje teške povrede. Takođe može da se koristi da upozori na nesigurne radnje.

 upozorava korisnika na prisustvo neizolovanog „opasnog napona“ unutar kućišta rashladnog uređaja. Napon je dovoljno velik da predstavlja opasnost od strujnog udara.

 ukazuje na prisustvo vrelih površina.

 ukazuje da je potrebno pročitati priručnik.

Nemojte da koristite opremu kao sterilni uređaj ili uređaj povezan na pacijenta. Pored toga, oprema nije predviđena za upotrebu na opasnim lokacijama klase I, II ili III prema definicijama Nacionalnog električnog standarda (engl. National Electrical Code).

Oprema je predviđena samo za upotrebu u zatvorenim prostorima. Nikad nemojte da je postavljate gde je prisutna prekomerna toplota, vlažnost, neodgovarajuće provetranje ili nagrizajući materijali. Radni parametri navedeni su u priručniku.

Povežite opremu na pravilno uzemljenu utičnicu.

Korišćena sredstva za hlađenje su teža od vazduha a i, ako dođe do curenja, zamenite kiseonik te dovesti do gubitka svesti. Kontakt sa sredstvom za hlađenje koje curi uzrokuje opekotine. Pogledajte pločicu s podacima cirkulatora za vrstu korišćenog sredstva za hlađenje, a zatim potražite dodatne informacije u najnovijem bezbednosnom listu za SAD (engl. Safety Data Sheet; SDS), ranije poznatom kao MSDS, kao i bezbednosnom listu za EU.

Oprezno pomerajte opremu. Naglo drmanje ili ispuštanje opreme može da ošteti njene komponente. Pre pomeranja opreme uvek je isključite i iskopčajte iz napona izvora napajanja.

Nikad nemojte da koristite oštećenu opremu ili opremu koja propušta.

Nikad nemojte da koristite zapaljive ili nagrizajuće tečnosti. Koristite samo odobrene tečnosti koje su navedene u priručniku. Pre korišćenja bilo kakve tečnosti ili obavljanja postupaka održavanja u kojima će verovatno doći do kontakta s tečnošću, potražite dodatne informacije u najnovijem bezbednosnom listu za SAD (engl. Safety Data Sheet; SDS) i bezbednosnom listu za EU.

Pre pomeranja opreme uvek je isključite i iskopčajte iz napona izvora napajanja.

Servisiranje i popravke treba da obavlja kvalifikovani serviser.

Opremu držite na rasponu temperature od -25 °C do 60 °C (s pakovanjem) i relativnoj vlažnosti od <80 %.

Stavljanje izvan pogona mora da obavi isključivo kvalifikovani trgovac pomoću certifikovane opreme. Mora da se pridržava svih važećih propisa.

Obavljanje postupaka ugradnje, korišćenja ili održavanja koji nisu opisani u priručniku može da dovede do opasne situacije i poništiće garanciju proizvođača.

Polarni rashladni uređaji nisu predviđeni za podno montiranje. Pre pokretanja ostavite rashladni uređaj u uspravnom položaju 24 sata na sobnoj temperaturi (~25 °C). Na ovaj se način osigurava da ulje za podmazivanje istekne nazad u kompresor.

Nikad nemojte da primenjujete linijski napon na komunikacijske priključke na rashladnom uređaju.

Nemojte da koristite antifriz za automobile. Komercijalni antifriz sadrži silikate koji oštećuju zaptivke pumpe.

Prilikom upotrebe mešavine radne tečnosti od etilen glikola/vode ili propilen glikola/vode, redovno proveravajte koncentraciju tečnosti i pH vrednost. Promene u koncentraciji i pH vrednosti mogu da utiču na performanse sistema.

Nemojte da koristite uložak filtera za dejonizaciju s inhibiranim etilen glikolom ili inhibiranim propilen glikolom. Filter za dejonizaciju uklanjanja inhibitora iz rastvora, što tečnost čini neefikasnom za zaštitu od korozije. Pored toga, inhibitori povećavaju provodljivost tečnosti.

Softver polarnog rashladnog uređaja mora da se prilagodi da bi odgovarao korišćenju radnoj tečnosti.

Biocidi su nagrizajući i mogu da dovedu do nepopravljivih oštećenja očiju i opekotina. Štetni su ako se udahnu, progutaju ili upiju kroz kožu. Pogledajte najnoviji bezbednosni list proizvođača.

Ako se filter kondenzatora ne čisti/menja, dolazi do gubitka kapaciteta hlađenja i prevremenog kvara sistema hlađenja.

Na vazduhom hlađenim rashladnim uređajima okvir i vertikalni stabilizatori kondenzatora nalaze se iza sklopa prednje rešetke i vrlo su oštri.

S izuzetkom vazduhom hlađenog sklopa rešetke nikad nemojte da koristite rashladni uređaj kad je bilo koja ploča skinuta.

Namena, cirkulirajući rashladni uređaji:

Cirkulirajući rashladni uređaji kompanije Thermo Scientific su predviđeni za pružanje neprekidne isporuke tečnosti uz konstantnu temperaturu i protok. Rashladni uređaj se sastoji od vazduhom hlađenog ili vodom hlađenog rashladnog sistema, izmenjivača toplote, cirkulirajuće pumpe, rezervoara radne tekućine i kontrolera mikroprocesora.

Rashladni uređaji su predviđeni za neprekidan rad i upotrebu u zatvorenim prostorima u skladu sa svim postupcima i zahtevima navedenim u njihovim priručnicima.

Ugradnja, cirkulirajući rashladni uređaji:

Postavite rashladni uređaj tako da bude blizu i ima lak pristup svom uređaju za iskopčavanje.

Rashladni uređaj je predviđen za upotrebu na namenskoj utičnici.

Obavezno skinite sve ambalažne čepove vodovodnih creva pre ugradnje.

Kod rashladnih uređaja Polar, da bi se sprečilo oštećenje vodovoda rashladnog uređaja mora se koristiti podešavajući kličuč od 19 mm za skidanje/postavljanje vanjskih priključaka.

Priključni rashladne tekućine nalaze se sa zadnje strane rashladnog uređaja i označeni su sa  (PROCESS OUTLET) (radni izlazni otvor) i  (PROCESS INLET) (radni ulazni otvor). Povežite  na ulazni otvor za tečnost na uređaju. Povežite  na izlazni otvor za tečnost na uređaju.

Pre pokretanja rashladnog uređaja dvaput proverite sve relevantne komunikacijske, električne i vodovodne priključke.

Viktiga säkerhetsinstruktioner Återcirkulerande kylare

Om någon av dessa anvisningar är svåra att förstå se handboken eller kontakta oss innan du går vidare.

Säkerhet, alla produkter:

 anger en imminent riskfylld situation som, om den inte undviks, resulterar i allvariga skador eller dödsfall.

 anger en riskfylld situation som, om den inte undviks, kan resultera i dödsfall eller allvarig skada.

 anger en riskfylld situation som, om den inte undviks, kan resultera i lättare eller medelsvåra skador. Den ska även användas för att varna om riskfyllda metoder.

 avsedd för att varna användaren om ej isolerad "farlig spänning" inuti kylarens hölje. Spänningen är tillräckligt hög för att utgöra en risk för elchock.

 anger att det finns heta ytor.

 anger att man bör läsa i handboken.

Använd inte utrustningen som steril eller ansluten till patient. Utrustningen är heller inte designad för användning i riskfyllda miljöer Klass I, II eller III, enligt definition i Nationella elbestämmelser.

Utrustningen är endast designad för inomhusbruk. Placera den aldrig på en plats med hög värme, fuktighet, otillräcklig ventilation eller där det förekommer frätande ämnen. Se handboken för driftsparametrar.

Anslut utrustningen till ett korrekt jordat uttag.

Kylmedium som används är tyngre än luft och kommer, om en läcka uppstår, att tränga ut syre vilket orsakar medvetlöshet. Kontakt med läckande kylmedium orsakar brännskador på hud. Se cirkulationspumpens namnskytt för typ av kylmedium som används och sedan tillverkarens aktuella US Säkerhetsdatablad (SDS), tidigare kallat MSDS, och EU Säkerhetsdatablad för ytterligare information.

Flytta utrustningen varsamt. Plötsliga ryck eller fall kan skada dess komponenter. Stäng alltid av utrustningen och koppla bort strömförsörjningen innan den flyttas.

Använd aldrig skadad eller läckande utrustning.

Använd aldrig brandfarliga eller frätande vätskor. Använd endast godkända vätskor som listas i handboken. Innan man använder vätskor eller utför underhåll där man troligen kommer i kontakt med vätskor ska man se tillverkarens aktuella US Säkerhetsdatablad (SDS) och EU Säkerhetsdatablad för ytterligare information.

Stäng alltid av utrustningen och koppla bort strömförsörjningen innan den flyttas.

Överlåt service och reparationer till en behörig tekniker.

Förvara utrustningen inom temperaturområdet -25°C till 60°C (i förpackning) och <80 % relativ luftfuktighet.

Urtagning ur drift för endast utföras av behörig återförsäljare med certifierad utrustning. Alla gällande bestämmelser måste följas.

Installations-, drift- eller underhållsprocedurer, förutom de som beskrivs i handboken, kan resultera i riskfyllda situationer och kommer att upphäva tillverkarens garanti.

Polar-kylare är inte designade för golvmontage. Lämna kylare i en upprätt position vid rumstemperatur (-25°C) under 24 timmar innan den startas. Detta försäkrar att smörjoljan har runnit tillbaka till kompressorn.

Applicera aldrig nätspänning till någon av kylarens kommunikationsanslutningar.

Använd inte kylmedel för bilar. Kommersiella frysskydd innehåller silikat som skadar pumpens tätningar.

När man använder en vätskeblandning med EG/vatten eller PG/vatten, så ska man kontrollera vätskekoncentrationen och pH-värdet regelbundet. Ändringar i koncentration och pH-värde kan påverka systemets prestanda.

Använd inte avjoningsfilter (DI) med inhiberat EG eller inhiberat PG. Ett avjoningsfilter avlägsnar inhibitorer från lösningen vilket gör vätskan ineffektiv mot rost. Inhibitorer höjer även vätskans konduktivitet.

Programvaran i Polar-kylare måste justeras för att fungera med den använda processvätskan.

Biocider är frätande och kan orsaka permanenta skador på ögon och brännskador på huden. De är skadliga vid inandning, förtäring eller om de absorberas genom huden. Se tillverkarens aktuella SDS.

Om man inte rengör/ersätter kondensatorfiltret föroror man kylningsprestanda, vilket snabbare leder till fel i kylningssystemet.

På luftfyllda kylare så är kondensatorns ram och fönor bakom gallret mycket skarpa.

Man aldrig starta kylaren med någon panel borttagen.

Avsedd användning, Återcirkuleringskylare:

Återcirkuleringskylare från Thermo Scientific är designade för att tillhandahålla kontinuerligt vätskeflöde vid en konstant temperatur och hastighet. Kylaren består av ett lyft- eller vattenkyllt kylningssystem, värmeväxlare, återcirkuleringspump, behållare för processvätska och en styrmodul med mikroprocessorer.

Kylare är designade för kontinuerlig drift och för inomhusbruk i enlighet med alla procedurer och krav som anges i denna handbok.

Installation, Återcirkulerande kylare:

Placera kylaren så att den befinner sig nära, med enkel åtkomst till, dess avstängningsanordning.

Kylaren är avsedd för att användas med ett för detta avsett uttag.

Försäkra att alla transportskydd avlägsnas från rör innan installation.

För att förebygga skador vid installation/borttagning av rören på Polar-kylare, så ska man använda en 19 mm nyckel på de externa anslutningarna-

Processvätskornas anslutningar sitter på kylarens baksida och är märkta med  (PROCESS OUTLET) och  (PROCESS INLET). Anslut  till vätskeinloppet på er applikation. Anslut  till vätskeutloppet på er applikation.

Innan kylaren startas så ska man dubbelkolla alla kommunikationer, samt elektriska och avloppsanslutningar.

Section 2 General Information

Description and Intended Use

The Thermo Scientific Accel Series of Cooling/Heating Recirculating Chillers are designed to provide a continuous supply of fluid at a constant temperature and flow rate. The chiller consists of an air-cooled refrigeration system, heat exchanger, recirculating pump, polyethylene reservoir, and a microprocessor controller.

All chillers have a low liquid level protection device.

Chillers are designed for continuous operation and for indoor use on a work bench or table top only, not floor standing. Use the chiller in accordance with all the procedures and requirements stated in this manual.

Specifications

Process Fluid Temperature Range

Temperature Stability

Cooling Capacity¹

	Accel 250 LC/Accel 500 LC	Accel 500 LT	Accel 500 LT/HT
Process Fluid Temperature Range	-10°C to +80°C +14°F to +176°F	-25°C to +80°C -13°F to +176°F	-25°C to +95°C -13°F to +203°F
Temperature Stability	±0.1°C	±0.1°C	±0.1°C
Cooling Capacity ¹			
Heater Capacity at 20°C 50Hz/60Hz	2.0 / 1.2 Kilowatts	2.0 / 1.2 Kilowatts	2.0 / 1.2 Kilowatts
Nominal Weight kg/lb	30 / 66	30 / 66	30 / 66
Pumping Type ² (see next page for curves)	Force / Force-Suction	Force / Force-Suction	Force / Force-Suction
Maximum Flow Rate lpm gpm	15 / 21 4.0 / 5.5	15 / 21 4.0 / 5.5	15 / 21 4.0 / 5.5
Maximum Pressure mbar psi	300 / 805 4.4 / 11.7	300 / 805 4.4 / 11.7	300 / 805 4.4 / 11.7
Reservoir Volume liters/gallons	2.8 / 0.7	2.8 / 0.7	2.8 / 0.7
Serial Interface	USB	USB	USB

1. Specifications obtained at sea level using water (above 5°C) and 50/50 EG/Water (<5°C) as the recirculating fluid at a 20°C process setpoint, 20°C ambient condition, at nominal operating voltage. Other fluids, process temperatures, ambient temperatures, altitude or operating voltage will affect performance.

2. Nominal values ±10%. Depends on chiller's pump type, force only or force/suction. Derate 100V/50Hz chillers ~15% for maximum pressure and maximum flow.

• Thermo Fisher Scientific reserves the right to change specifications without notice.

FP1 Pumping Capacity

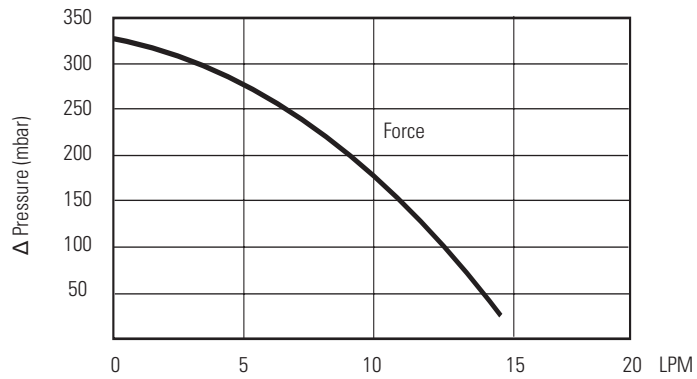

FP2 Pumping Capacity

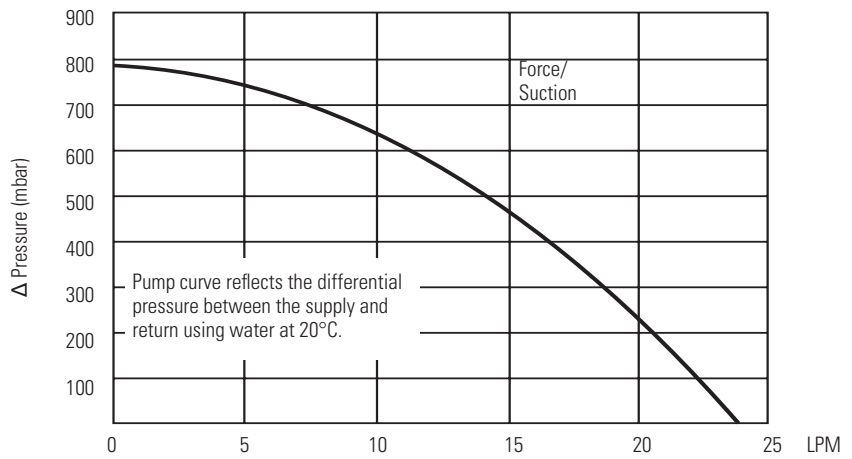

Time to Temperature

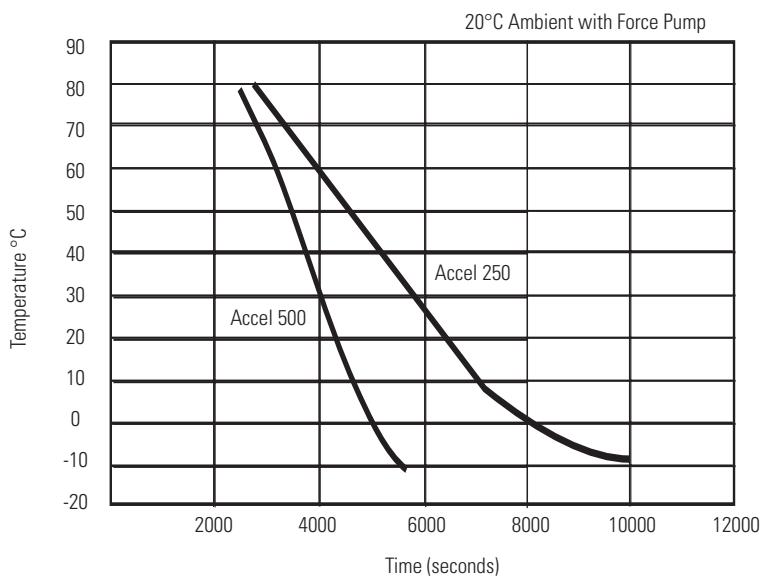

Dimensions
(inches/centimeters)
Top View

H x W x D
24.8 x 9.1 x 19.2 in
(62.0 x 23.2 x 48.7 cm)

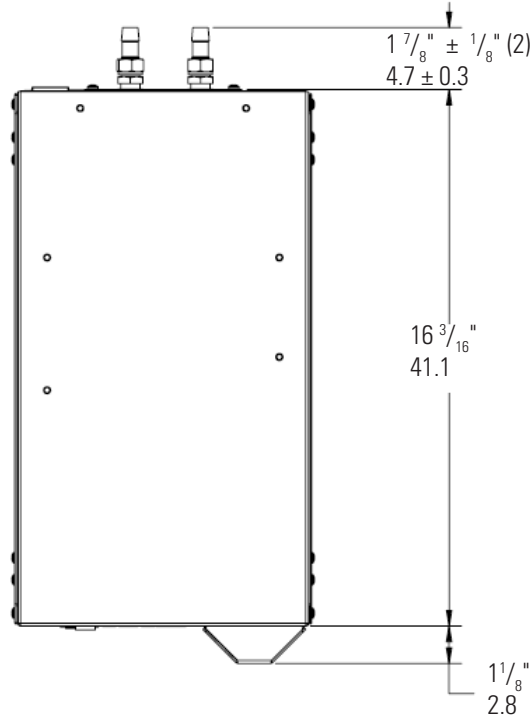

Front View

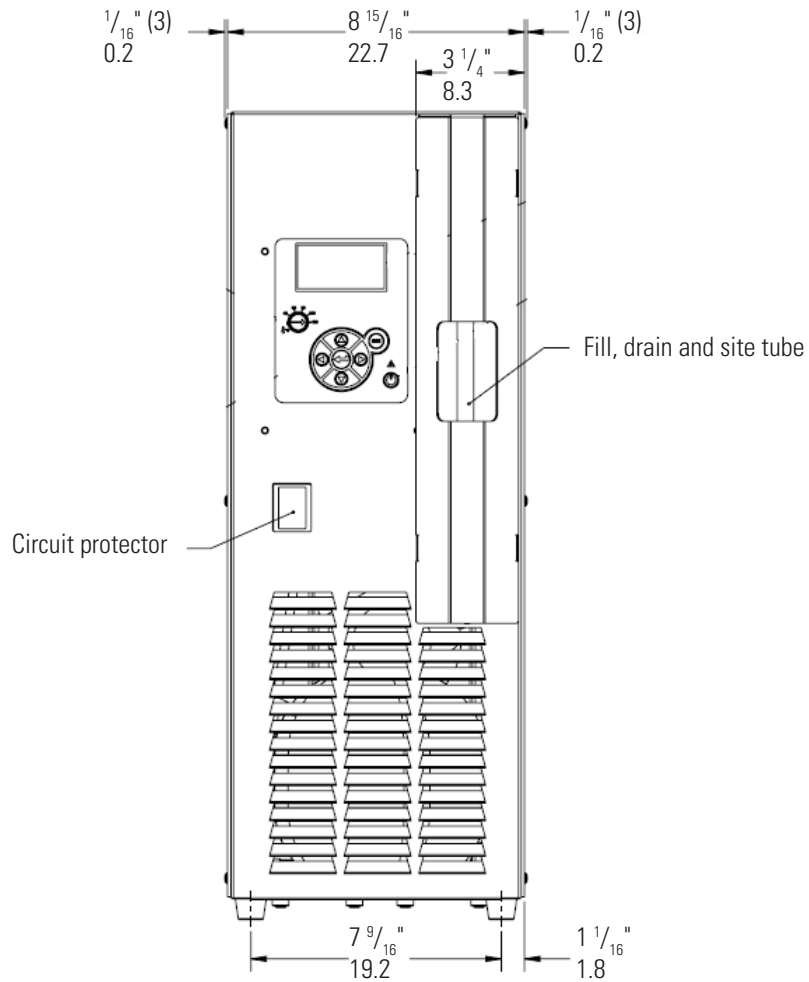

Rear View

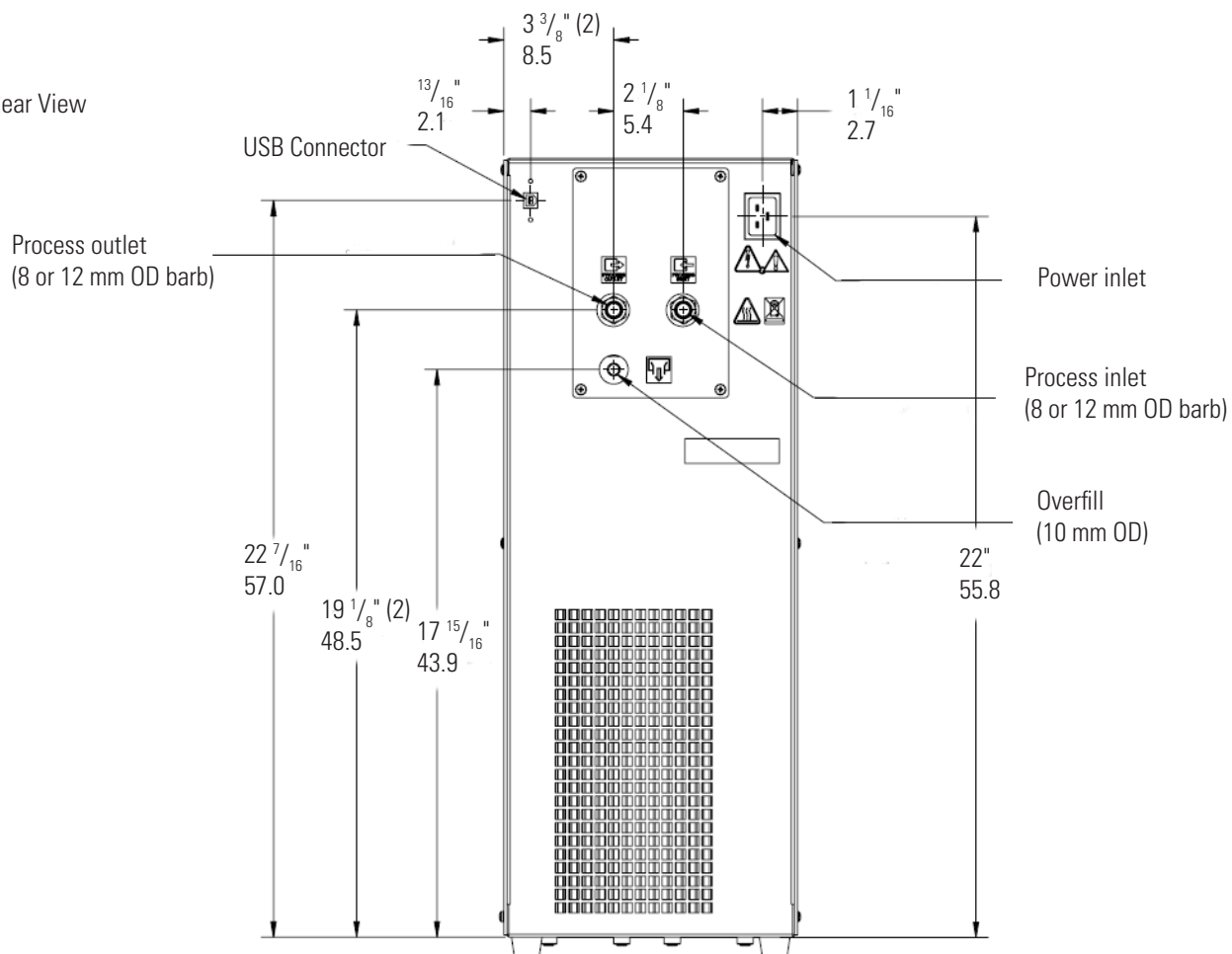

Side View

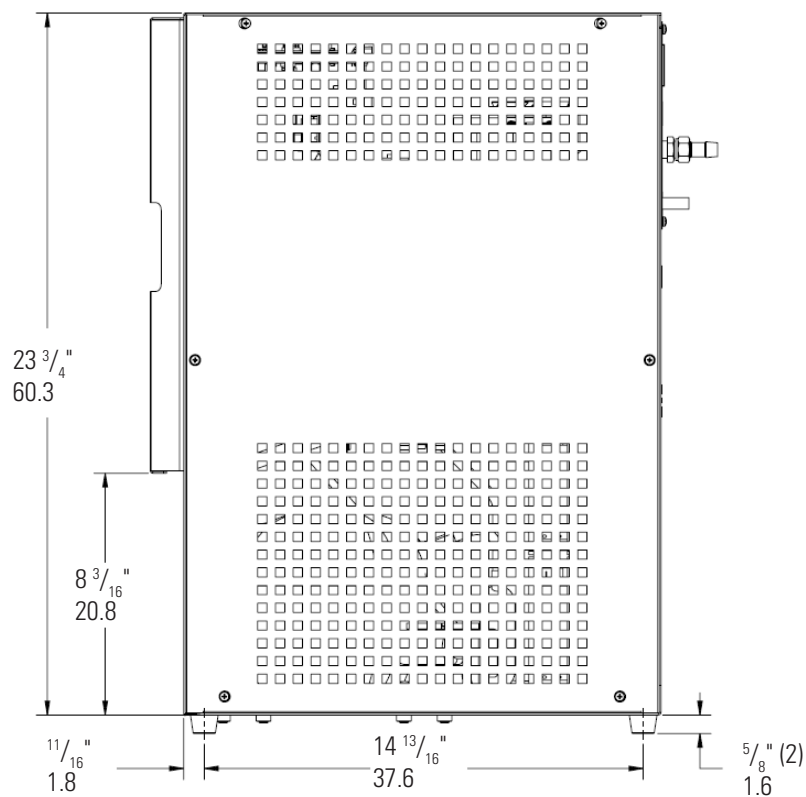

Equipment Ratings

Compliance



Ambient Temperature Range

10°C to 40°C (50°F to 104°F)

Maximum Relative Humidity (Non Condensing)*

0% to 80% at 31°C (88°F)

Operating Altitude*

Sea Level to 2000 meters (6560 feet)

Overvoltage Category

II

Pollution Degree

2

Degree of Protection

IP 20

Sound Power Level

less than 58 dBA

Refrigerant

6.7 ounces R134A

*Limited by ambient temperature, elevation & operating temperature. Maximum relative humidity 80% for temperatures up to 31°C decreasing linearly to 50% relative humidity at 35°C Elevation above sea level requires reduction of 1°C/1000m on maximum ambient and 2%/1000m reduction in rated capacity.

The following power options are available:

Volts ¹ /Hertz/Phase	Amps ²	Total Wattage	Plug Type
115/60/1	12	1345	N5-15
100/50-60/1	12	1150	N5-15
220- 230/50/1	12	2395	Country Specific
220/60/1	12	2395	Country Specific

1. Vac over the range ± 10%

2. Maximum amp draw

3. Refer to chiller's nameplate for additional information

Approved Fluids

5°C to 80°C — Distilled Water or Deionized Water (up to 3 MΩ-cm)

Normal tap water leads to calcareous deposits necessitating frequent unit decalcification, see table on next page.

Calcium tends to deposit itself on the heating element. The heating capacity is reduced and service life shortened.

-10°C to 80°C — 50/50 Water with Laboratory Grade Ethylene Glycol

Wetted Materials

Viton

Vectra

EPDM

Stainless Steel 316

Ryton

Stainless Steel 304

Ultem

Section 3 Installation

The desk-top chiller is designed for continuous operation and for indoor use.



The chiller is not designed to be floor-mounted. ▲



Never place the chiller in a location where excessive heat, moisture, inadequate ventilation, or corrosive materials are present. ▲



Leave chillers in an upright position at room temperature (~25°C) for 24 hours before starting. This ensures the lubrication oil has drained back into the compressor. ▲

Ventilation

The chiller requires clean air for proper operation. Air enters from the rear of the chiller and exits through the sides and front.

The chiller is design to allow blocking of any two sides (except rear) without affecting rated load. The ambient temperature is reduced by 3°C if two sides are blocked.

Electrical Requirements



The chiller's construction provides protection against the risk of electrical shock by grounding appropriate metal parts. The protection will not function unless the power cord is connected to a properly grounded outlet. It is the user's responsibility to assure a proper ground connection is provided. ▲

The chiller is intended for use on a dedicated outlet. Chillers are equipped with a C20 main power inlet and a 20 Amp circuit protector.

Note If the circuit protector activates allow the chiller to cool before resetting the protector. Restart the chiller. Contact us if it activates again. ▲



The chiller's power cord is the electrical disconnecting device, it must be easily accessible at all times. ▲



Operate the chiller using only the supplied line cord, never operate equipment with damaged cords. ▲



Refer to the nameplate on the rear, upper-left-hand corner of the chiller for specific electrical requirements. Voltage range deviations of $\pm 10\%$ are permissible. The outlet must be rated as suitable for the total power consumption of the chiller.

Plumbing Requirements



Ensure that all shipping plugs are removed before installation.

Never connect the process fluid lines to your facility water supply or any pressurized liquid source. ▲

The process fluid connections are located on the rear of the chiller and are labeled  (PROCESS OUTLET) and  (PROCESS INLET).

Connect the PROCESS OUTLET  to the fluid inlet on your application.

Connect the PROCESS INLET  to the fluid outlet on your application.

Connect the reservoir overflow  to a suitable drain. Ensure that the cap is removed and that the overflow is connected to a suitable drain or vessel.

Ensure all connections are secure.

Keep the distance between the chiller and the instrument being cooled as short as possible. To minimize back pressure, ensure tubing is as straight as possible. If diameter reductions are required, make them at the inlet and outlet of your application, not at the chiller.

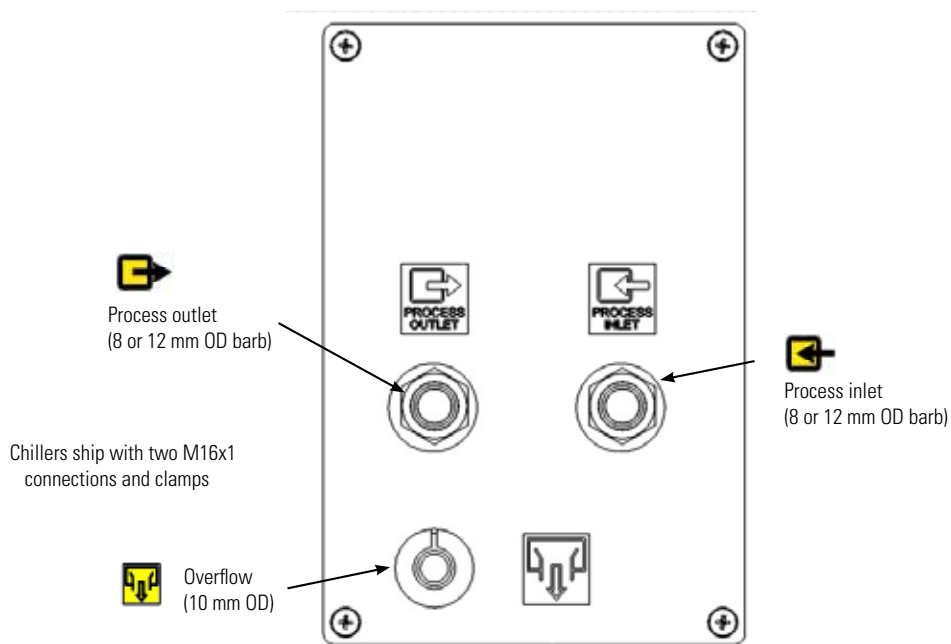

To prevent damage to the chiller's plumbing, use a 19 mm backing wrench when removing/installing the external connections. ▲

Fluid Considerations



Only use the approved fluids listed on the next page. Never use corrosive fluids with this chiller. ▲



Handle and dispose all liquids, other than water, in accordance with the fluid manufacturers specification and/or the fluid MSDS. ▲



Always adjust the chiller's software to the fluid used, see Section 4. ▲



Water/ethylene glycol mixtures require top-offs with pure water, otherwise the percentage of glycol increases resulting in high viscosity and poor performance. ▲

Thermo Fisher Scientific takes no responsibility for damages caused by the selection of an unapproved fluid.

Unapproved fluids are fluids which:

- are very highly viscous (much higher than 30 mPas at the respective working temperature)
- have corrosive characteristics or
- tend to break down at high temperatures

For fluid selection consider application requirements, operating temperature range, material compatibility, safety concerns, and environmental issues.

Chlorine

Short term usage of tap water may not cause any adverse affects on the chiller or your application, but in the long term problems may arise. To help alleviate these problems Thermo Fisher Scientific recommends the use of chlorine.

The duration of time that chlorine remains in solution depends on factors such as water temperature, pH and availability of direct sunlight. We recommend maintaining chlorine levels at proper levels using chlorine test strips, generally 1 to 5 ppm is adequate.

For best results, maintain the pH of the fluid between 6.5 and 7.5. Don't add additional chlorine without first determining the concentration ratio that already exists in the fluid supply. Corrosion and degradation of the circulation components can result from concentration ratios that are too high. Contact our customer support for additional information.

Approved Fluids

Distilled Water or Deionized Water (up to 3 MΩ-cm)

For applications requiring resistivity greater than 1 MΩ-cm please call and speak to an applications engineer for additional information.

Normal tap water leads to calcareous deposits necessitating frequent chiller decalcification, see table on next page. Calcium tends to deposit itself on the heating element. The heating capacity is reduced and service life shortened.

50/50, by volume, Water with Laboratory Grade Ethylene Glycol

Below 5°C water has to be mixed with a glycol. The amount of glycol added should cover a temperature range 5°C lower than the operating temperature of the particular application. This prevents the water/glycol from gelling (freezing) near the evaporating coil.

50% ethylene glycol by volume is the maximum recommendation. Excess glycol deteriorates the temperature accuracy due to its high viscosity.

All our heat transfer fluids are supplied with an EC Safety Data Sheet.



When selecting the heat transfer fluid ensure that no toxic gases can be generated. Inflammable gases can build up during usage. ▲

Water Quality and Standards

Process Fluid	Permissible (PPM)	Desirable (PPM)
Microbiologicals		
(algae, bacteria, fungi)	0	0
Inorganic Chemicals		
Calcium	<25	<0.6
Chloride	<25	<10
Copper	<1.3	<1.0
	0.020 ppm if fluid in contact with aluminum	
Iron	<0.3	<0.1
Lead	<0.015	0
Magnesium	<12	<0.1
Manganese	<0.05	<0.03
Nitrates\Nitrites	<10 as N	0
Potassium	<20	<0.3
Silicate	<25	<1.0
Sodium	<20	<0.3
Sulfate	<25	<1
Hardness	<17	<0.05
Total Dissolved Solids	<50	<10
Other Parameters		
pH	6.5-8.5	7-8
Resistivity	0.01*	0.05-0.1*

* MΩ-cm (compensated to 25°C)

Unfavorably high total ionized solids (TIS) can accelerate the rate of galvanic corrosion. These contaminants can function as electrolytes which increase the potential for galvanic cell corrosion and lead to localized corrosion such as pitting. Eventually, the pitting becomes so extensive that refrigerant leaks into the reservoir.

As an example, raw water in the United States averages 171 ppm (of NaCl). The recommended level for use in a water system is between 0.5 to 5.0 ppm (of NaCl).

Recommendation: Initially fill the reservoir with distilled or deionized water. Do not use untreated tap water as the total ionized solids level may be too high. This reduces the electrolytic potential of the water and prevent or reduce the galvanic corrosion observed.

Filling Requirements



Before using any fluid refer to the manufacturer’s MSDS and EC safety data sheets for handling precautions. ▲

Note Ensure the reservoir overflow located on the rear of the chiller is connected to a suitable drain. ▲

Start with 2.8 liters of fluid.

Lift up on the fill panel on the front of the chiller to remove it.

Insert the supplied funnel into the hose and *slowly* add fluid.



Note Due to the chiller's plumbing configuration, adding fluid too quickly may result in overfilling - the fill level indication lags the actual amount added. ▲

When pouring fluid into the funnel ensure the fluid contacts the side of the funnel first, A. Pouring the fluid into the center of the funnel, B, causes air pockets and substantially slows down the filling time.

Using the fill lines, verify the desired fluid level.

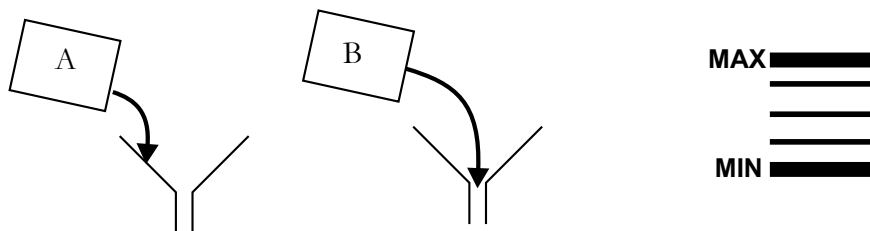

Since the reservoir capacity may be small compared to your application, and air may need to be purged from the lines, have extra cooling fluid on hand to keep the system topped off when external circulation is started.



Avoid overfilling, fluids expand when heated. ▲

Draining



Before draining any fluid refer to the manufacturer's SDS and EC Safety Data Sheet for handling precautions. ▲



Ensure the fluid is at a safe handling temperature (~40°C). Wear protective clothing and gloves. ▲

Lift up on the fill panel on the front of the chiller to remove it.

Pull the fill hose off the clips securing it to the chiller.

Keep your thumb on the end of the hose until ready to drain the fluid into a suitable container.



Storage



If the chiller is to be transported and/or stored in cold temperatures it needs to be drained and then flushed with a 50/50 laboratory grade glycol/water mixture. ▲

The chiller can be stored for up to 90 days inside the temperature range of -20°C to +60°C (-4°F to +140°F).

If necessary, when removing the chiller from storage allow it time to warm up and dry out in order to prevent any condensation issues.

Section 4 Operation

Controller

The Thermo Scientific Accel Series of chillers have a digital display and easy-to-use touch pad, five programmable setpoint temperatures, acoustic and optical alarms and adjustable high temperature protection.

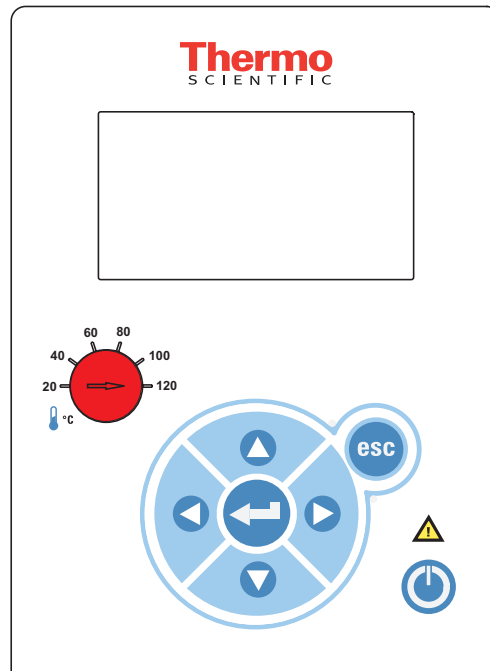

This label indicates read the instruction manual before starting the chiller.



Use this button to place the chiller in and out of stand by.



Use these navigation arrows to move through the controller displays and to adjust values.



Use this button to start/stop the chiller. This button is also used to make and save changes on the controller's display screen.



Use this button to cancel any changes and to return the controller to its previous display. Canceling a change can only be made before the change is saved. In some cases, it is also used to save changes.

Note Holding this button for five seconds resets the display contrast to the default level and also brings up the language menu to change, if needed, the displayed language. See **Settings - Display Options** in this Section. ▲



Use the adjacent dial for adjusting the High Temperature Cutout. Details are explained in the end of this Section.

Setup



Leave the chiller in an upright position at room temperature (~25°C) for 24 hours before starting. This ensures the lubrication oil has drained back into the compressor. ▲





Before starting the chiller, double check all USB, electrical and plumbing connections. ▲

Start Up

Do not run the chiller until fluid is added. Have extra fluid on hand. If the chiller does not start refer to Section 5 Troubleshooting.

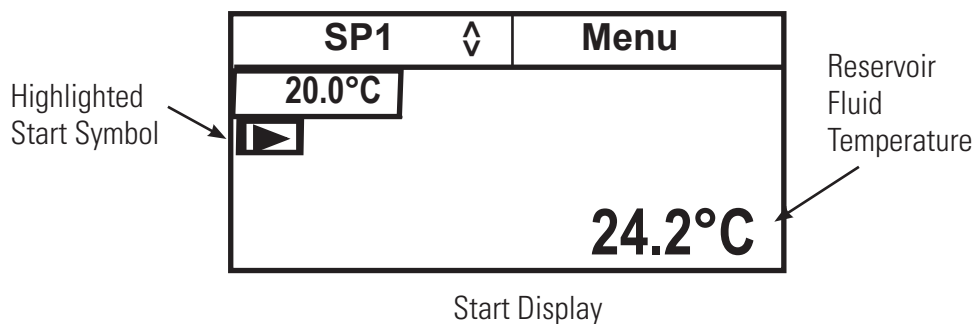
- Place the circuit protector located on the front of the chiller to the **I** position.
- Press , the Start Display appears
- Ensure the start symbol has a highlight box around it, if not use the arrow keys to navigate to the symbol.



- Press . The chiller starts and the start symbol turns into a stop symbol (■).



Note It takes 30 seconds for the compressor to start. ▲

Note After start, check external plumbing connections for leaks. ▲

The **SP1** and **Menu** portions on the top of the display are used to view and/or change the controller's settings. They are explained in detail later in this Section.

Status Display

If desired, press  to toggle between the Start/Status Displays.

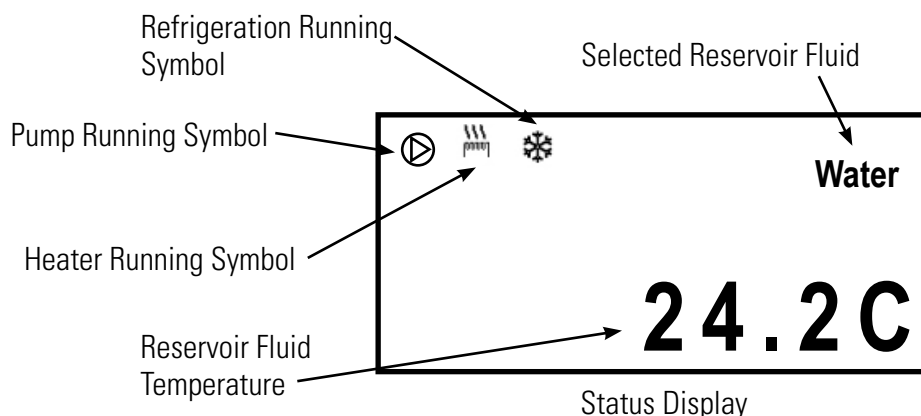



Stand By Mode

Press , the chiller enters the stand by mode.

Stopping the Chiller

Ensure the stop symbol is highlighted, if not use the arrow keys to navigate to the symbol.

Press . The chiller stops and the stop symbol turns into a start symbol ().

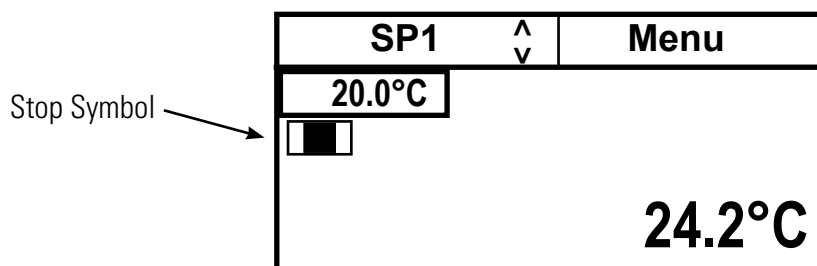

Power Down

Press , the chiller enters the stand by mode.

Shut Down

Place the circuit protector on the front of the chiller to the  position. The display goes blank.



Using any other means to shut the chiller down can reduce the life of the compressor. ▲



Always turn the chiller off and disconnect it from its supply voltage before moving the chiller. ▲



The circuit protector located on the front of the chiller is not intended to act as a disconnecting means. ▲

Restarting

Note When quickly restarting, the compressor may take up to 10 minutes before it starts to operate. Limit chiller cycling to 8 times/hour. ▲

Changing the Setpoint

Note You cannot adjust the setpoint closer than 0.1°C to either of the fluid's system limits, see Fluids Type in this Section, or beyond the chiller's temperature range. ▲

Note The setpoint can be changed with the chiller running or not. ▲

The setpoint is the desired fluid temperature. The controller can store up to five setpoints, **SP1** through **SP5**. The procedure for changing the stored setpoint values is discussed later in this Section.

Use the navigation arrows and move to the setpoint window and then press  to highlight it and the value window as shown below.

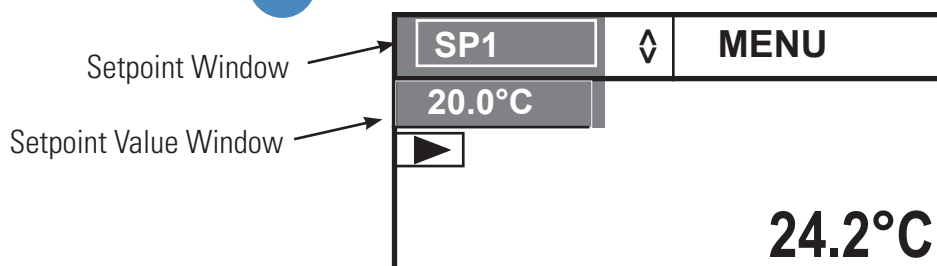

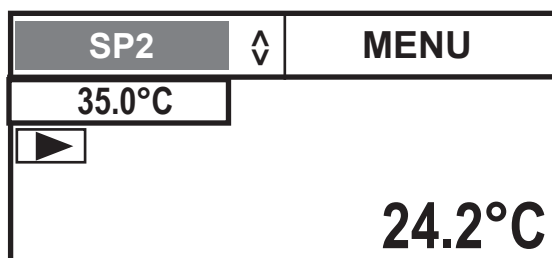

Use the up and down navigation arrows to bring up the desired setpoint and then press .

The display on the Setpoint Value Window now indicates the corresponding setpoint's stored value.

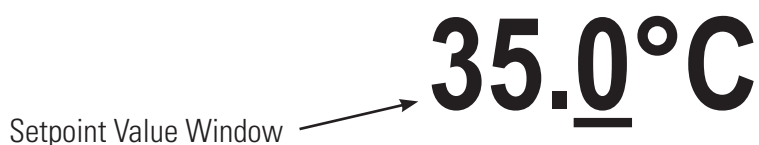

If desired, you can change the displayed setpoint value by using the navigation arrows to highlight the Setpoint Value Window and then pressing . The right-most digit has a cursor beneath it.





Use the left and right arrows to move the cursor to the desired digit and then use the up and down arrows to change the value. Once all the desired changes are made, press  to save the change.

Note Using this procedure also changes the setpoint's stored value.

Menu Displays

The controller uses menus to view/change the chiller's settings.

Note The chiller does not need to be running to view/change these settings. ▲

For all **Menu** displays, once  is pressed to change a display, you can press  to return to the previous screen.

1. Use the arrow buttons to highlight **Menu** and the controller brings up the Main Menu Display.

SP1	↕	Menu
Settings		^
System		v

2. Use the up and down arrow to highlight either **Settings** or **System** and then press  to bring up additional submenus.

Application Settings	^
Display Options	
	v
Menu	

See page 4-7.

SP1	↕	Menu
Settings		^
System		v

Messages	^
Run Time	
Configuration	
Password/Reset	v
Menu	

See page 4-12.

Menu

The **Menu** line, at the bottom of all the submenu displays, is another way to return the controller back to the Main Menu Display.

1. From any submenu display, use the down arrow button to highlight **Menu**.

2. Press  to return to the Start Display.

Application Settings	^
Display Options	
	v
Menu	

SP1	↕	MENU
20.0°C		
		
		24.2°C

Note Pressing  from the Menu line returns you to the previous screen. ▲

Menu Tree

Since the controller can only display five lines of text at a time, keep pressing the down arrow to view any additional options.

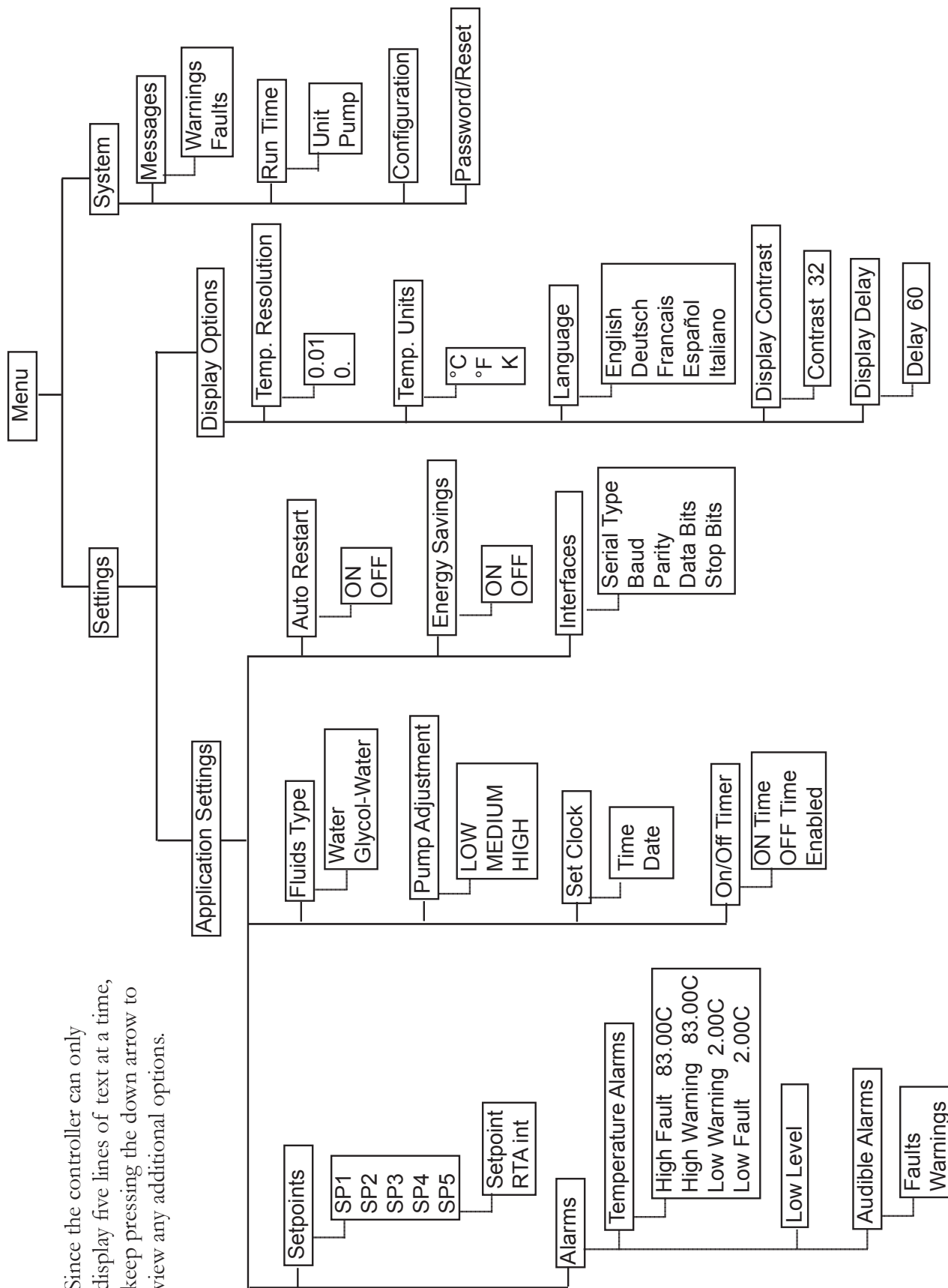

Settings - Application Settings is used to view/adjust the controller's five Setpoints and Real Temperature Adjustments (RTA), enable/disable the alarms, change the fluid type, set the pump speed, configure the interfaces (optional), set the clock, turn the timer on or off, and turn auto restart and energy savings on or off.

1. With **Application Settings** highlighted press  to view:

Setpoints	^
Alarms	
Fluid Type	
Pump Adjustment	v
Menu	

2. Scroll down for additional options:

Interfaces	^
Set Clock	
On/Off Timer	
Auto Restart	v
Menu	

3. With **Setpoints** highlighted, press  to display the list. Use the up/down arrows to highlight the desired **SP**. **Note** Use the down arrow to display **SP5**. ▲

SP1	^
SP2	
SP3	
SP4	v
Menu	

4. Press .

SP1	XX.X	^
RTA int	XX.X	
		v
Menu		

If the temperature on the Start/Status Displays do not accurately reflect the actual temperature in the reservoir, an RTA can be applied. The RTA can be set $\pm 10^{\circ}\text{C}$ ($\pm 18^{\circ}\text{F}$).

As an example, if the chiller's temperature is stabilized and displaying 20°C but a calibrated reference thermometer reads 20.5°C , set the RTA to -0.5°C . After you enter a RTA value allow chiller to stabilize before verifying the temperature. **Note** If display accuracy is required, we recommend repeating this procedure at various setpoint temperatures and on a regular basis. ▲

Note You cannot adjust the setpoint closer than 0.1°C to either of the fluid's system limits, see Fluids Type in this Section. ▲

5. With the desired line highlighted press .

The right-most digit has a cursor beneath it. Use the left and right arrows to move the cursor to the desired digit and then use the up and down arrows to change the value. Once all the desired changes are made, press .

or press  to cancel the change.

35.0°C

Alarms is used to view/adjust the high and low temperature alarm limits, to configure the low level reaction and to enable/disable the audible alarms.

1. With **Alarms** highlighted, press  to display:

Temperature Alarms	^
Low Level	
Audible Alarms	
	v
Menu	

2. With **Temperature Alarms** highlighted, press  to display:

High Fault	83.0°C	^
High Warn	83.0°C	
Low Warn	2.0°C	
Low Fault	2.0°C	v
Menu		

3. Highlight the desired limit and press . Follow the same procedure used to change a setpoint.



If the **Fault** temperature is exceeded the chiller shuts down and, if enabled, the audible alarm sounds. If the **Warn** temperature is exceeded the chiller continues to run and, if enabled, the audible alarm sounds. In both cases a message is displayed.

High Fault cannot be set below **High Warn**.
High Warn cannot be set below **Low Warn**.
Low Fault cannot be set above **High Warn**.

Press , or use the **Menu** window, to save and return to the previous display.

1. With **Low Level** highlighted, press  to display:

Level	Warning
Menu	

2. Press  and the display starts to flash, use the arrow keys to toggle between **Warning** and **Faults**. With the desired option showing press  again to stop the flashing.

A low level condition occurs when the fluid is approximately at the **MIN** reservoir level fill line. A low level condition can either generate a warning or a fault. With warning (the default setting) selected the chiller continues to run, with fault selected the chiller shuts down. In either case a message is displayed and, if enabled, sounds the alarm.

1. With **Audible Alarms** highlighted, press



to display the alarms.

Highlight the desired alarm and press  to toggle between enable and disable mode.

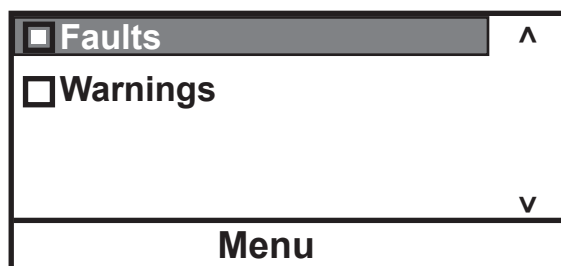

If **Faults** is enabled the alarm sounds when a fault occurs. If **Warnings** is enabled the alarm sounds when a warning occurs.

Press , or use the **Menu** window, to save and return to the previous display.

Fluids Type is used to identify the type of fluid used. The controller uses the fluid type to automatically set certain operating parameters.

1. With **Fluid Type** highlighted, press  to display the list of acceptable fluids.

Highlight the desired fluid and press  to select it.

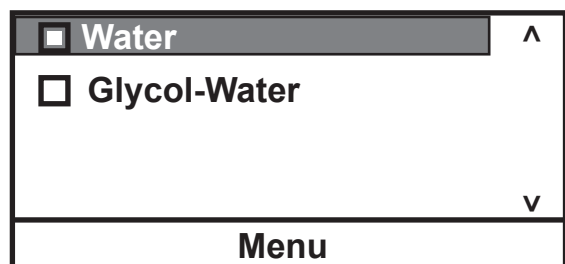

2. With the desired fluid selected press , or use the **Menu** window, to save and return to the previous display.

Pump Adjustment is used to review/set the desired pump speed. **Note** Force only pumps (FP1) have only two speeds, **High** and **Low**. ▲

1. With **Pump Adjustment** highlighted, press



to display the speeds.

Highlight the desired speed and press  to select it.

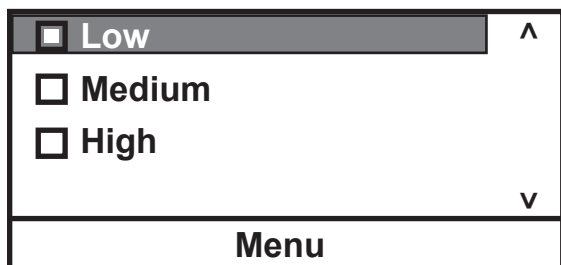

LC Fluid temperature alarm limits:		
	High °C/°F	Low °C/°F
Water	+83/+181	+2/+36
EG-Water	+83/+181	-13/+9
LT Fluid temperature alarm limits:		
	High °C/°F	Low °C/°F
Water	+83/+181	+2/+36
EG-Water	+83/+181	-28/-18
LT/HT Fluid temperature alarm limits:		
	High °C/°F	Low °C/°F
Water	+98/+208	+2/+36
EG-Water	+98/+208	-28/-18

Set Clock is used to set the controller's time (hr : min : sec) and date (year - month - day).

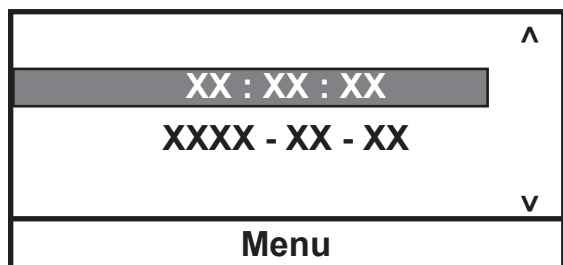

On/Off Timer is used to enable and set the controller's timer.

1. With **On/Off Timer** highlighted, press  to display the on (I) and off (O) time as well as the enable box.

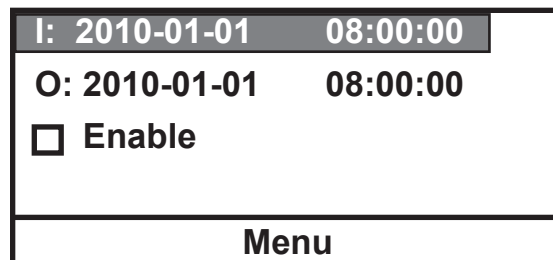

After setting the on and off times select **Enable** to activate the timer.

Auto Restart is used to enable the auto restart feature. When enabled, the chiller automatically restarts after a power failure or power interruption condition is restored. **NOTE** Consider any possible risks before enabling this mode of operation. ▲

1. With **Auto Restart** highlighted, press  to toggle between enable and disable.

Energy Saving is used to enable the energy savings mode. The Energy Saving mode is primarily designed for applications running under a stable load. Enabling the mode saves energy by reducing the chiller's heater power and cooling requirements. This can result in substantial energy savings over the life of the chiller. The default setting is **ON**.

1. With **Energy Saving** highlighted, press  to toggle between enable and disable.

Interfaces is used to enable/configure the optional communications feature. The controller supports AC, NC and Standard protocols.

1. With **Interfaces** highlighted, press  to display the list of parameters.

Highlight the desired parameter and press  to view the available options.

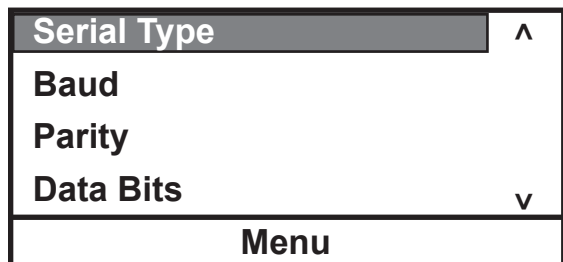

Available options:

Serial Type	USB, Off
Baud	19200, 9600, 4800, 2400, 1200, 600, 300
Parity	None, Odd, Even
Data Bits	8
Stop Bits	1, 2

See the Appendix for additional information.

Settings - Display Options is used to view/adjust the controller's Temperature Units, the Temperature Resolution, the displayed Language, the Display Contrast and the Display Delay.

1. With **Temp. Unit** highlighted press .
Use the up/down arrows to highlight the desired temperature scale. Press .

<input checked="" type="checkbox"/> °C	^
<input type="checkbox"/> °F	
<input type="checkbox"/> K	v
Menu	

2. With **Temp. Resolution** highlighted press .

Use the up/down arrows to highlight the desired resolution. Press .



<input type="checkbox"/> 0.01	^
<input checked="" type="checkbox"/> 0.1	
	v
Menu	

3. With **Language** highlighted press .
Use the up/down arrows to highlight the desired language. (Scroll down for additional languages.)

Press .

<input checked="" type="checkbox"/> English	^
<input type="checkbox"/> Deutsch	
<input type="checkbox"/> Francais	
<input type="checkbox"/> Español	v
Menu	

4. With **Display Contrast** highlighted press .

Press  again and use the up/down arrows keys to change the contrast. With the desired contrast showing, press  again.

Contrast	32	^
		v
Menu		

Note Holding  for five seconds resets the display contrast to the default level and also brings up the language menu to change, if needed, the displayed language. ▲

5. With **Display Delay** highlighted press  to enable/disable it.

Use the up/down arrows to highlight the time and press  again.

Use the up/down arrows to change the value. Once the desired delay is displayed press .

<input checked="" type="checkbox"/> Delay	^
60 sec	v
Menu	

With **Display Delay** enabled and the Start Display showing, if no arrows are pressed the Start Display changes to the Status Display after the delay expires. See pages 4-2 and 4-3.

System

SP1	^	Menu
Settings		^
System		
		v

Messages is used to view any **Warnings** or **Faults** messages.

1. With **Messages** highlighted, press  to display the options.

Warnings	^
Faults	
	v
Menu	

Configuration is used to view the chiller's configuration.

1. With **Configuration** highlighted, press  to display the settings.

Pump	FPXXX
FW	XXXXXXXX.A
Checksum	XXXX
Bath	ACL250; 115V
FW	XXXXXXXX.A
Menu	

Messages	^
Run Time	
Configuration	
Password/Reset	v
Menu	

Run Time is used to view the chiller (**Unit**) and **Pump** operating hours.

1. With **Run Time** highlighted, press  to display the times.

Unit	xxx hours	^
Pump	xxx hours	
		v
Menu		

Pump options:

- FP1LE** Force Pump, Low Level
- FP2LE** Force/Suction Pump, Low Level
- FP1ULE** Force Pump, USB, Low Level
- FP2ULE** Force/Suction Pump, USB, Low Level
- FP2ULEHT** Force/Suction Pump, USB, Low Level, High Temp

Password/Reset is used only by a qualified technician. Changing the password enables controller reset options, the temperature sensor calibration procedure and displays PID values.

1. With **Password/Reset** highlighted, press  to display:

Level	User	^
Password	0	
		v
Menu		

2. Press  and change the number to **1**.

Level	User	^
Password	1	
		v
Menu		

3. Press  to display:

Level	Operator	^
Password	1	
Reset		
Calibration		v
Menu		

Note The controller defaults to the **User** mode whenever the chiller is turned off. The controller also defaults to the **User** mode whenever the Start/Status Display is displayed continuously for 10 minutes. ▲

Scroll down to display **PID Tuning**.

1. If desired, highlight **Reset** and press  to display:

Reset user settings	^
Reset PID settings	
Reset Both	
	v
Menu	

Highlight the desired reset option and press .

A confirmation message appears, press  again. The controller enters the stand by mode.

1. To calibrate the temperature sensor highlight **Calibration** and press  to display:

Internal RTD	^
	v
Menu	

3. Press  to display:

Internal RTD	xx.x	^
High	xx.x	
Low	xx.x	
Calibrate	SP	xx.x v
Menu		

5. Depending on which end you are calibrating highlight **High** or **Low**. Once the **Internal RTD** temperature stabilizes enter the temperature displayed on your reference thermometer and press .

Internal RTD	xx.x	^
High	xx.x	
Low	xx.x	
Calibrate	SP	xx.x v
Menu		

7. Repeat for the low end setpoint.

Internal RTD	xx.x	^
High	xx.x	
Low	xx.x	
Calibrate	SP	xx.x v
Menu		

2. Press  to display:

Calibrate	^
Restore User Cal	
Save User Cal	
Restore Factory Cal	v
Menu	

4. Highlight the **SP** temperature box and enter either the desired high end or low end setpoint value and press .

Internal RTD	xx.x	^
High	xx.x	
Low	xx.x	
Calibrate	SP	xx.x v
Menu		

6. Highlight **Calibrate** and then press  to complete the high end procedure.

Internal RTD	xx.x	^
High	xx.x	
Low	xx.x	
Calibrate	SP	xx.x v
Menu		

Once complete you can store the calibration into memory by selecting **Save User Cal** and pressing .

You can later restore the same calibration by highlighting **Restore User Cal** and pressing



Another option is to restore the factory calibration values by highlighting **Restore Factory Cal** and pressing .

PID Tuning is used to view/change the controller's PID values. **Note** We recommend only a qualified technician change the values, incorrect values will impede chiller performance. ▲

1. With **PID Tuning** highlighted, press  to display:

Cool PID	^
Heat PID	
	v
Menu	

2. Highlight the desired PID and press  to display:

P	XX.X	^
I	x.xx	
D	x.xx	
		v
Menu		

3. If required, press  to change the value.

P	xx. <u>x</u>	^
I	x.xx	
D	x.xx	
		v
Menu		

Factory values are:

P = 05.0

I = 0.10

D = 0.00

High Temperature Cutout

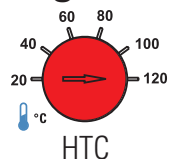

To protect your application, the adjustable High Temperature Cutout (HTC) ensures the heater does not exceed temperatures that can cause serious damage. A temperature sensor is located in the reservoir. A HTC fault occurs when the temperature of the sensor exceeds the set temperature limit.

In the event of a fault the chiller shuts down and the controller displays a fault message, see Section 6. The cause of the fault must be identified and corrected before the chiller can be restarted.

The HTC is factory preset fully clockwise to the highest possible setting. To set the cutout start the chiller and adjust the setpoint a few degrees higher than the highest desired fluid temperature. Allow the chiller to stabilize at the temperature setpoint. Then, using a flathead screwdriver, slowly turn the red dial counterclockwise until the chiller shuts down and the fault message appears. Press  to clear the message.

Before you can restart the chiller it has to cool down a few degrees. To restart the chiller press the black reset ring surrounding the red dial - and then press the enter key again. If Auto Restart is enabled the chiller restarts, if disabled use the Start Up procedure.

Note: We recommend periodically rechecking operation or if the chiller is moved. ▲

Section 5 Preventive Maintenance



Laboratory Grade Ethylene glycol (EG) is poisonous and flammable. Before performing any preventive maintenance refer to the manufacturer's most current MSDS for handling precautions. ▲



Disconnect the power cord prior to performing any maintenance. Ensure chiller is at a safe temperature before handling. ▲



Handle the chiller with care. Sudden jolts or drops can damage its components. ▲

There are no user serviceable components within the equipment cabinet. Only Thermo Fisher should provide required replacement parts listed below.

Cleaning

Clean the chiller's surface with a soft cloth and warm water only.

Condenser

Clean the condenser by running a vacuum over the grid on the lower rear section of the chiller.



Failure to clean the condenser will cause a loss of cooling capacity and lead to premature failure of the cooling system. ▲

Clean/replace the optional condenser filter.

Fluid Maintenance

Check the fluid level, concentration and pH on a regular basis, see Section 3. Change the fluid if it is discolored.

Sight Tube

As required, clean the sight tube using a small soft brush.

Hoses

Inspect and tighten the chiller's external hoses and clamps daily

Testing the Safety Features

The safety features for low fluid level protection and high fluid temperature must be checked at regular intervals. The frequency depends on the chiller's designated application and the heat transfer fluid used.

Low liquid level protection

With the chiller on, slowly drain the reservoir fluid (use a drainage tap if necessary) and ensure the controller displays a message and the chiller reacts as desired.

If not, have the chiller checked by qualified a technician.



High temperature protection

Using a flat-head screw driver, set a cut-off temperature that is lower than the desired setpoint temperature.

Switch on the circulator and ensure the chiller shuts down at the set cut-off temperature. Press the black ring surrounding the dial to reset the HTC.

If the chiller does not shut down have it checked by a qualified technician.

Reset the safety to the desired temperature.

Decommissioning/ Disposal



Decommissioning prepares equipment for safe and secure transportation.

Laboratory Grade Ethylene glycol (EG) is poisonous and flammable. Before disposing refer to the manufacturer's most current MSDS for handling precautions. ▲



Handling and disposal should be done in accordance with the manufacturers specification and/or the MSDS for the material used. ▲



Decommissioning must be performed only by qualified dealer using certified equipment. All prevailing regulations must be followed. ▲

Consider decommissioning the chiller when:

- It fails to maintain desired specifications
- It no longer meets safety standards
- It is beyond repair for its age and worth

Refrigerant (R134A) and oil (Polyol Ester) must be recovered from equipment before disposal.

Note Keep in mind any impact your application may have had on the chiller. ▲

Direct questions about chiller decommissioning or disposal to our Sales, Service and Customer Support.

Section 6 Troubleshooting

Error Displays

The circulator can display error messages and, if enabled, sound an alarm. Error messages are cleared by pressing the enter key (↵). Restart the circulator once the cause of the error message is identified and corrected. If the cause was not corrected the error code will reappear, contact our Sales, Service and Customer Support. If **Auto start** is enabled the circulator will restart, if disabled use the Start Up procedure.

**FAULT:
High Temperature
PRESS ENTER
to clear message**

Error Display (Typical)

Fault Displays





The heating element, pump and, if applicable, refrigeration shut down with a fault. A fault also sounds the alarm, if enabled.

Message	Cause	Actions
High Fixed Temp.	<ul style="list-style-type: none"> circulator's nonadjustable high temperature protection limit exceeded 	<ul style="list-style-type: none"> clear message by pressing the enter key (↵) check fluid selection check environmental conditions
High Temperature	<ul style="list-style-type: none"> adjustable high temperature protection limit exceeded 	<ul style="list-style-type: none"> clear message by pressing the enter key (↵) check limit setting check fluid selection ensure circulator has adequate ventilation
High Temperature Refrigeration	<ul style="list-style-type: none"> high refrigeration temperature 	<ul style="list-style-type: none"> clear message by pressing the enter key (↵) check voltage supply the refrigeration may need servicing, contact us
HPC High Press. Cutout	<ul style="list-style-type: none"> the high refrigeration pressure cutout activated 	<ul style="list-style-type: none"> clear message by pressing the enter key (↵) check for obstructions to air flow the refrigeration may need servicing, contact us

Message	Cause	Actions
HTC High Temp. Cutout	<ul style="list-style-type: none"> the high temperature cutout limit was exceeded 	<ul style="list-style-type: none"> clear message by pressing the enter key (↵) allow chiller to cool down to at least 10°C below than the HTC setting turn the red knob on the HTC fully clockwise press the HTC's black reset ring press the enter key (↵) again reset HTC to desired setting, see Section 4 if message reappears recycle power to chiller and repeat the procedure 
LLC Low Level Cutout	<ul style="list-style-type: none"> reservoir fluid level too low for safe operation 	<ul style="list-style-type: none"> clear message by pressing the enter key (↵) check fluid level check for leaks
Low Fixed Temp.	<ul style="list-style-type: none"> circulator's nonadjustable low temperature protection limit exceeded 	<ul style="list-style-type: none"> clear message by pressing the enter key (↵) check fluid selection
Low Temperature	<ul style="list-style-type: none"> adjustable high temperature protection limit exceeded 	<ul style="list-style-type: none"> clear message by pressing the enter key (↵) check limit setting check fluid selection
Motor Fault	<ul style="list-style-type: none"> high motor temperature 	<ul style="list-style-type: none"> clear message by pressing the enter key (↵) it can take over 10 minutes for the motor temperature to get low enough before the circulator can be restarted
MOL Motor Overload	<ul style="list-style-type: none"> high motor overload temperature 	<ul style="list-style-type: none"> clear message by pressing the enter key (↵) allow circulator to cool down
Open RTD1 Internal	<ul style="list-style-type: none"> open internal temperature sensor 	<ul style="list-style-type: none"> clear message by pressing the enter key (↵)
Shorted RTD1 Internal	<ul style="list-style-type: none"> shorted internal temperature sensor 	<ul style="list-style-type: none"> clear message by pressing the enter key (↵)

Warning Displays

The circulator will continue to run with a warning. A warning also sounds the alarm, if enabled.

Message	Cause	Actions
Bad Calibration	<ul style="list-style-type: none"> bad temperature probe calibration 	<ul style="list-style-type: none"> clear message by pressing the enter key () redo calibration
High Temperature	<ul style="list-style-type: none"> adjustable high temperature protection limit exceeded 	<ul style="list-style-type: none"> clear message by pressing the enter key () check limit setting check fluid selection
Low Level	<ul style="list-style-type: none"> reservoir fluid level too low for safe operation 	<ul style="list-style-type: none"> clear message by pressing the enter key () check fluid level
Low Temperature	<ul style="list-style-type: none"> adjustable low temperature protection limit exceeded 	<ul style="list-style-type: none"> clear message by pressing the enter key () check limit setting check fluid selection

Checklist

Chiller will not start

Check the controller for error displays, see Error Displays in this section.

Ensure the circuit protector is in the on (I) position.

Make sure supply voltage is connected and matches the chiller's nameplate rating $\pm 10\%$.

No display on controller

Cycle the circuit protector on the front of the chiller.

Chiller will not circulate process fluid

Check the reservoir level. Fill, if necessary.

Check the application for restrictions in the cooling lines.

The pump motor overloaded. The pump's internal overtemperature overcurrent device shuts off the pump causing the flow to stop. This can be caused by low fluid, debris in system, operating chiller in a high ambient temperature condition or excessively confined space. Allow time for the motor to cool down.

Make sure supply voltage matches the chiller's nameplate rating $\pm 10\%$.

Inadequate temperature control

Verify the setpoint.

Make sure the condenser and the optional filter are free of dust and debris.

Check the fluid concentration.

Ensure chiller installation complies with the requirements in Section 3.

Make sure supply voltage matches chiller nameplate rating $\pm 10\%$.

If the temperature continues to rise, make sure your application's heat load does not exceed the rated specifications.

Check for high thermal gradients (e.g., the application load is being turned on and off or rapidly changing).

Inadequate pump pressure

Ensure any user installed in-line valves are in the desired position.

Ensure the chiller's process fluid outlet is connected to the application's fluid inlet and not the application's fluid outlet, see Section 3.

Ensure all connections are secure and that the proper sealant/lubricant for the fitting material is used.

Keep the distance between the chiller and the instrument being cooled as short as possible.

Ensure tubing is straight and without bends. If diameter reductions are required, make them at the inlet and outlet of your application, not at the chiller.

Chiller shuts down

Ensure  button wasn't accidentally pressed.

Ensure the circuit protector is in the on (I) position.

Check the controller for error displays.

Make sure supply voltage is connected and matches the chiller's nameplate rating $\pm 10\%$.

Restart the chiller.

USB Driver Not Recognized

If your operating system does not automatically recognize the USB driver log on to:

<http://www.ftdichip.com/FTDrivers.htm>

for instructions.

Please contact Thermo Fisher Scientific Sales Service and Customer Support if you need any additional information, see inside cover for contact instructions.

Appendix AC Serial Communications Protocol

Serial communication is accomplished through the USB port on the chiller. If your operating system does not automatically recognize the optional driver log on to: <http://www.ftdichip.com/FTDrivers.htm> for instructions.

Note This appendix assumes you have a basic understanding of communications protocols. Information on the NC, STANDARD and NAMUR protocols is available upon request. ▲

Note Controller operation is still available with serial communications enabled. ▲

All commands must be entered in the exact format shown in the tables on the following pages. The tables show all commands available, their format and responses. Chiller responses are either the requested data or an error message. The chiller response must be received before the host sends the next command.

The host sends a command embedded in a single communications packet, then waits for the chiller's response. If the command is not understood, the chiller responds with an error command. Otherwise, the chiller responds with the requested data.

Commands are not case sensitive. Upper or lower case letters may be used. Commands are listed in the Commands Table, error responses are given in the Errors Table, and symbols are shown in the Key Table.

Key	
Symbol	Meaning
[B]	A binary value 0 or 1 (0 = Off, FALSE or Disable(d); 1 = On, TRUE or Enable(d)).
[CR]	Carriage return – used as the termination character.
[U]	Text representing the units associated with a value.
[V]	A value that can be requested in a read command or sent as part of a set command.
[V _{MAX}]	Maximum allowed value. Part of error message when set value is too high.
[V _{MIN}]	Minimum allowed value. Part of error message when set value is too low.

Value: Read commands return analog [V] or bit [B] values or settings, while set commands send analog or bit settings. Read commands return values with the same displayed precision. Set command messages missing the space character between the command and the setting will be rejected, as the user's intent is unclear.

Units: A read command returning an analog [V] value or setting, will include the units [U] associated with that value or setting. A set command sending an analog value will not include the units. The units returned by the complementary read command are assumed.

Termination character: A carriage return [CR] is used to terminate command and response messages. (Typically the "Enter" key on the keyboard.)

Note The inter-character timeout (time between transmitted characters) is set to 30 seconds. Exceeding the timeout clears the receiver buffer and requires the user to retransmit the message.

Note Special characters (backspace, delete, insert, etc.) are not recognized by the protocol and generate error responses.

Commands Table:

Commands		<i>All messages from master and slave are terminated with a carriage return [CR]</i>	
Command Description	<i>Notes</i>	Master Sends	Sample Slave Response <i>(echo off)</i> <i>Alternate units</i>
Read Temperature	<i>Internal</i>	RT	[V]C F K
Read Displayed Setpoint		RS	[V]C F K
Read Setpoint X (X = 1 to 5)		RSX	[V]C F K
Read Internal RTAX (X = 1 to 5)		RIRTAX	[V]C F K
Read High Temperature Fault		RHTF	[V]C F K
Read High Temperature Warn		RHTW	[V]C F K
Read Low Temperature Fault		RLTF	[V]C F K
Read Low Temperature Warn		RLTW	[V]C F K
Read Proportional Cool Band Setting		RPC	[V]%
Read Integral Cool Band Setting		RIC	[V]Repeats per minute
Read Derivative Cool Band Setting		RDC	[V]Minutes
Read Temperature Precision		RTP	[V]
Read Temperature Units		RTU	[V] C,F,K
Read Unit On		RO	[B]
Read Auto Restart Enabled		RAR	[B]
Read Energy Saving Mode		REN	[B]
Read Time		RCK	hh:mm:ss
Read Date		RDT	mm/dd/yyyy or dd/mm/yyyy
Read Date Format		RDF	mm/dd/yyyy or dd/mm/yyyy
Read Firmware Version		RVER	[V]
Read Firmware Checksum		RSUM	[V]
Read Unit Fault Status		RUFS	[V ₁ , V ₂ , V ₃ , V ₄ , V ₅] See page 5

Commands			
<i>All messages from master and slave are terminated with a carriage return [CR]</i>			
Command Description	Notes	Master Sends	Sample Slave Response <i>(echo off)</i> <i>Alternate units</i>
Set Displayed Setpoint		SS [V]	OK
Set Setpoint X (X = 1 to 5)		SSX [V]	OK
Set Internal RTA X (X = 1 to 5)		SIRTAX[V]	OK
Set High Temperature Fault		SHTF [V]	OK
Set High Temperature Warning		SHTW [V]	OK
Set Low Temperature Fault		SLTF [V]	OK
Set Low Temperature Warning		SLTW [V]	OK
Set Proportional Cool Band Setting		SPC [V]	OK
Set Integral Cool Band Setting		SIC [V]	OK
Set Derivative Cool Band Setting		SDC [V]	OK
Set Temperature Resolution		STR [V]	OK
Set Temperature Units		STU [V] C,F,K	OK
Set Unit On Status		SO [B]	OK
Set Auto Restart Enabled		SAR [B]	OK
Set Energy Saving Mode		SEN [V]	OK
Set Pump Speed		SPS [V] L,M,H	OK

Errors Table:

Errors		
Error Description	Notes	Slave Responds
<i>Not defined, not implemented or incorrectly formatted</i>		? Unsupported command
<i>Extra characters...</i>		? Format error
<i>Set value too high</i>		? Maximum allowed is $[V_{MAX}]$
<i>Set value too low</i>		? Minimum allowed is $[V_{MIN}]$
<i>Argument to binary set command not 0 or 1</i>		? Value must be 0 or 1
<i>Set command attempted while in read only mode</i>		? Mode is read only
<i>Set command failed (e.g. SO 1 with low level)</i>		? Failed

RUFS Read Unit Fault Status

This command returns 5 values. These are decimal representations of hexadecimal values. Each individual bit of the value represents a different warning, fault or status.

decimal	hex	B7	B6	B5	B4	B3	B2	B1	B0
1	1	0	0	0	0	0	0	0	1
2	2	0	0	0	0	0	0	1	0
4	4	0	0	0	0	0	1	0	0
8	8	0	0	0	0	1	0	0	0
16	10	0	0	0	1	0	0	0	0
32	20	0	0	1	0	0	0	0	0
64	40	0	1	0	0	0	0	0	0
128	80	1	0	0	0	0	0	0	0

Value	Description of bits
V_1	B0 - B5 unused B6 rtd1 shorted B7 rtd1 open
V_2	B0 HTC fault B1 high RA temperature fault B2 - B7 unused
V_3	B0 low level warn B1 lo temperature warn B2 high temperature warn B3 low level fault B4 lo temperature fault B5 high temperature fault B6 low temperature fixed fault B7 high temperature fixed fault
V_4	B0 PWM heat duty cycle > 0 B1 compressor On/Off B2 Pump On status B3 Unit On status B4 Unit Stopping B5 Unit fault status B6 unused B7 Beeper On status
V_5	B0 Pump speed fault B1 MOL fault B2 HPC fault B3 Cool Icon On steady (unit is cooling at max capacity) B4 Cool Icon flashing (unit is cooling) B5 Heat Icon On steady B6 Heat Icon flashing B7 External sensor controlling

Refer to Key table on page 1 for explanation of symbols and their meanings.

Examples:

Read Temperature:

Host

R	T		CR
Command			[CR]

Chiller:

2	0	.	0	C	CR
[V]			[U]	[CR]	

Set Setpoint:

Host

S	S		2	0	CR
Command			[V]	[CR]	

Chiller :

O	K	CR
Command Accepted		[CR]

Read Temperature 2:

Host:

R	T	2	CR	
2	0	.	0	C [CR]

Chiller:

Set Setpoint to -22°C when minimum allowed is -20°C: Minimum allowed is $[V_{MIN}]$

Host:

S	S		-	2	2	CR													
?	M i n i m u m a l l o w e d i s - 2 0 CR																		

Chiller:

DECLARATION OF CONFORMITY

Manufacturer: Thermo Fisher Scientific
Address: 25 Nimble Hill Road
Newington, NH 03801

We declare that the equipment named below has been designed to comply with the relevant sections of the below referenced specifications and is in accordance with the requirements of the indicated directives.

Product: Heated and Refrigerated Liquid Circulators

Models: Thermo Fisher Polar Series, Accel Models 250 and 500:

Directives and Standards:

2014/30/EC ± Electromagnetic Compatibility Directive (EMC)

- EN 61326-1: 2013 Electrical equipment for measurement, control, and laboratory use - EMC requirements. General requirements

2014/35/EC - Low Voltage Directive (LVD):

- EN 61010-1: 2010 Safety requirements for electrical equipment for measurement, control, and laboratory use -- Part 1: General requirements.
- EN 61010-2-010: 2003 Safety requirements for electrical equipment for measurement, control, and laboratory use - Part 2-010: Particular requirements for laboratory equipment for the heating of materials

2011/65/EU – Restriction of the use of certain hazardous substances in electrical and electronic equipment (RoHS Directive)

- EN 50581: 2012 - Technical documentation for the assessment of electrical and electronic products with respect to the restriction of hazardous substances

Authorised representative in the EC:

Name: Thermo Fisher Scientific
Address: Dieselstrasse 4
76227 Karlsruhe Germany

On behalf of the manufacturer:

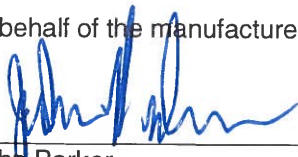

Date:

1 August 2016



John Parker
Electrical Engineering Manager
Temperature Control
Thermo Fisher Scientific
Newington, NH, USA

Warranty

Thermo Fisher Scientific warrants for 24 months from date of shipment the Thermo Scientific Accel chillers according to the following terms.

Any part of the chiller manufactured or supplied by Thermo Fisher Scientific and found in the reasonable judgment of Thermo Fisher to be defective in material or workmanship will be repaired at an authorized Thermo Fisher Repair Depot without charge for parts or labor. The chiller, including any defective part must be returned to an authorized Thermo Fisher Repair Depot within the warranty period. The expense of returning the chiller to the authorized Thermo Fisher Repair Depot for warranty service will be paid for by the buyer. Our responsibility in respect to warranty claims is limited to performing the required repairs or replacements, and no claim of breach of warranty shall be cause for cancellation or rescission of the contract of sales of any chiller. With respect to chiller that qualify for field service repairs, Thermo Fisher Scientific's responsibility is limited to the component parts necessary for the repair and the labor that is required on site to perform the repair. Any travel labor or mileage charges are the financial responsibility of the buyer.

The buyer shall be responsible for any evaluation or warranty service call (including labor charges) if no defects are found with the Thermo Scientific product.

This warranty does not cover any chiller that has been subject to misuse, neglect, or accident. This warranty does not apply to any damage to the chiller that is the result of improper installation or maintenance, or to any chiller that has been operated or maintained in any way contrary to the operating or maintenance instructions specified in this Instruction and Operation Manual. This warranty does not cover any chiller that has been altered or modified so as to change its intended use.

In addition, this warranty does not extend to repairs made by the use of parts, accessories, or fluids which are either incompatible with the chiller or adversely affect its operation, performance, or durability.

Thermo Fisher Scientific reserves the right to change or improve the design of any chiller without assuming any obligation to modify any chiller previously manufactured.

THE FOREGOING EXPRESS WARRANTY IS IN LIEU OF ALL OTHER WARRANTIES, EXPRESSED OR IMPLIED, INCLUDING BUT NOT LIMITED TO WARRANTIES OF MERCHANTABILITY AND FITNESS FOR A PARTICULAR PURPOSE.

OUR OBLIGATION UNDER THIS WARRANTY IS STRICTLY AND EXCLUSIVELY LIMITED TO THE REPAIR OR REPLACEMENT OF DEFECTIVE COMPONENT PARTS AND Thermo Fisher Scientific DOES NOT ASSUME OR AUTHORIZE ANYONE TO ASSUME FOR IT ANY OTHER OBLIGATION.

Thermo Fisher Scientific ASSUMES NO RESPONSIBILITY FOR INCIDENTAL, CONSEQUENTIAL, OR OTHER DAMAGES INCLUDING, BUT NOT LIMITED TO LOSS OR DAMAGE TO PROPERTY, LOSS OF PROFITS OR REVENUE, LOSS OF THE CHILLER, LOSS OF TIME, OR INCONVENIENCE.

This warranty applies to chillers sold by Thermo Fisher Scientific. (Refer to the warranty for chillers sold by the affiliated marketing company of Thermo Fisher Scientific for any additional terms.) This warranty and all matters arising pursuant to it shall be governed by the law of the State of New Hampshire, United States. All legal actions brought in relation hereto shall be filed in the appropriate state or federal courts in New Hampshire, unless waived by Thermo Fisher Scientific.

Thermo Fisher Scientific
81 Wyman Street
P.O. Box 9046
Waltham, Massachusetts 02454-9046
United States

www.thermofisher.com