

**Thermo Scientific Orion Star A112 Benchtop and
Star A122 Portable Conductivity Meters**

Reference Guide



Ross and the COIL trade dress are trademarks of Thermo Fisher Scientific, Inc. and its subsidiaries.

AQUAfast, AQUASensors, BOD AutoEZ, ionplus, KNIpHE, LogR, No Cal, ORION, perpHect, PerpHecT, pHISA, pHuture, Pure Water, Sage, ROSS, ROSS Ultra, Sure-Flow, Titrator PLUS, and TURBO2 are registered trademarks of Thermo Fisher Scientific, Inc. and its subsidiaries.

A+, All in One, Aplus, AUTO-BAR, AUTO-CAL, Auto-ID, AUTO-READ, AUTO-STIR, Auto-Test, AutoTraction, CISA, digital LogR, DuraProbe, EZ Startup, ISEasy, Low Maintenance Triode, Minimum Stir Requirement, MSR, NISS, Optimum Results, Orion Dual Star, Orion Star, SAOB, SMART AVERAGING, SMART STABILITY, Star LogR, Star Navigator 21, Stat Face, Triode are trademarks of Thermo Fisher Scientific, Inc. and its subsidiaries.

Guaranteed Success and The Technical Edge are service marks of Thermo Fisher Scientific, Inc. and its subsidiaries.

© 2011 Thermo Fisher Scientific Inc. All rights reserved. All trademarks are the property of Thermo Fisher Scientific, Inc. and its subsidiaries.

The specifications, descriptions, drawings, ordering information and part numbers within this document are subject to change without notice.

This publication supersedes all previous publications on this subject.

Thermo Scientific Orion Star A112 Benchtop and Star A122 Portable Conductivity Meters

Table of Contents

Chapter 1	Introduction	1
Chapter 2	Meter Overview	3
	Connections	3
	Display Information	4
	Keypad Information	5
	Meter Maintenance	5
Chapter 3	Meter Setup	7
	Navigating the Setup Menu	7
	Setup Examples	9
	<i>Read Type Selection</i>	<i>9</i>
	<i>Entering the Nominal Cell Constant for Conductivity</i>	<i>9</i>
	<i>Adjusting the TDS Factor</i>	<i>9</i>
Chapter 4	Calibration and Measurement	11
	Conductivity Calibration and Conductivity/TDS Measurement	11
	<i>Conductivity Calibration</i>	<i>11</i>
	<i>Conductivity /TDS Measurement</i>	<i>11</i>
	Temperature Measurement and Calibration	12
	<i>Temperature Measurement</i>	<i>12</i>
	<i>Temperature Calibration</i>	<i>12</i>
Chapter 5	Data Storage and Review	13
	Automatic Datalog with AUTO-READ™ Mode	13
	Manual Datalog with Continuous Read Mode	13
	Viewing Stored Readings (the Data Log)	13
Chapter 6	Customer Services	15
	Meter Error Codes	15
	Troubleshooting Guide	16
	Assistance	16
	Warranty and Registration	16
	WEEE Compliance	16
	Declaration of Conformity	17
	Meter Specifications	18
	Ordering Information	19
Chapter 7	Appendix	21
	<i>Temperature Compensation and Reference Temperature</i> ..	<i>21</i>
	<i>Total Dissolved Solids (TDS)</i>	<i>21</i>
	<i>Automatic Conductivity Calibration</i>	<i>22</i>
	<i>Table of Conductivity Standard Values vs. Temperature</i> ..	<i>22</i>
	Notes	24

This page intentionally left blank.

Chapter 1 Introduction

Thank you for your purchase of the Orion Star A112 benchtop conductivity or Star A122 portable conductivity meter. These meters are capable of measuring conductivity in $\mu\text{S}/\text{cm}$ or mS/cm ; TDS in mg/L ; and temperature in $^{\circ}\text{C}$ or $^{\circ}\text{F}$.

The Orion Star A112 benchtop conductivity meters are IP54-rated. The Orion Star A122 portable conductivity meters feature a waterproof, IP67-rating.

Please read this reference guide thoroughly. Any use outside of these instructions may invalidate your warranty and cause permanent damage to the meter.

This page intentionally left blank.

Chapter 2 Meter Overview

Connections

1. Power source:
 - a. Power adapter (included with Orion Star A112 benchtop conductivity meters, sold separately for Star A122 portable conductivity meters) – Select the appropriate wall socket plug. Slide off the clear plastic cover, and slide on the plug plate into the groove on the back of the adapter.
 - b. Batteries (included with and factory installed on Star A122 portable conductivity meters, sold separately for Star A112 benchtop conductivity meters) – Select four AA batteries. Confirm that the meter is off and remove the battery compartment cover. On the Star A122 portable meter, to remove the battery compartment cover:
 - i. Loosen the screws.
 - ii. Release the top portion of the battery compartment from the meter (using a coin or your finger.)
 - iii. Release the bottom portion of the battery compartment (using a coin or your finger). Insert batteries as shown in the battery compartment housing.

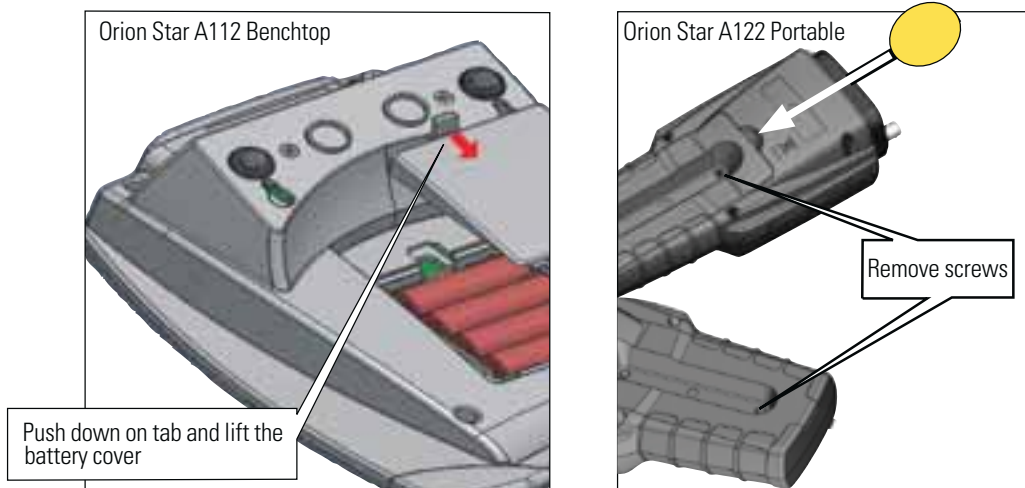

2. Prepare the conductivity probe according to the directions in the conductivity probe user guide. In general, this includes rinsing the cell with distilled water.
3. Connect the appropriate item as labeled on the meter and as shown in figure 1:

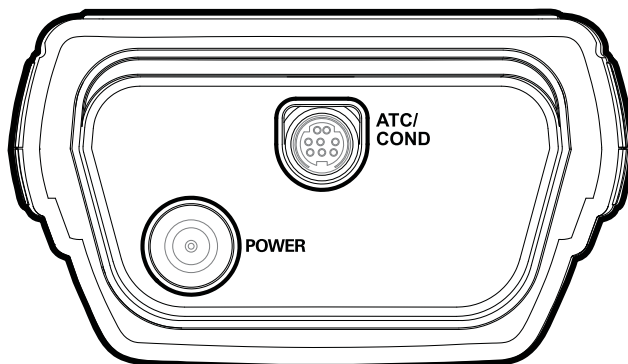
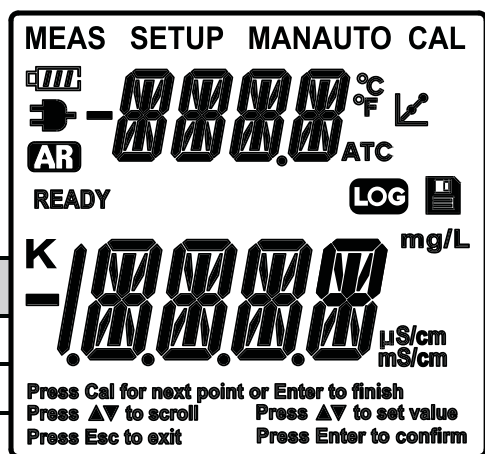









Figure 1

Display Information



Display Icon	Description
MEAS	Indicates that the meter is in the measurement mode.
SETUP	Indicates that the meter is in setup mode.
CAL	Indicates that the meter is the calibration mode.
MAN	Shown when a manual calibration is being done.
AUTO	Shown when automatic calibration buffers are used (100 µS/cm, 1413 µS/cm or 12.9 mS/cm).
	Shows the battery status (more bars = more power remaining). Blinks when power is low and the battery needs to be changed. (Orion Star A122 Conductivity portable meter includes factory-installed batteries.)
	Shown when the meter is running on AC power. (Orion Star A112 Conductivity benchtop meter includes adapter.)
AR	Shown when the meter is on AUTO-READ mode. Default setting. AR and unit of measure will blink until the reading is stable. When the reading is stable it is held on the screen and AR is lit. Press to take a new reading.
READY	Unit of measurement will blink until the reading is stable. When the reading is stable, READY is lit.
	Appears during calibration and after a calibration is done.
	Displayed when a reading is stored into the memory.
LOG	Displayed when viewing stored readings.
Secondary display	Upper display which shows temperature reading in measurement mode and setup menu in setup mode.
Primary display	Larger, lower display showing measured value in selected mode.
Instructions	Located below the primary display. These phrases aid in the setup menu and calibration modes.

Keypad Information

	<p><i>In the measurement screen:</i> Press to take a measurement.</p> <p><i>In the setup screen:</i> Press to escape the setup menu.</p> <p><i>In the calibration screen:</i> Press to abort calibration.</p>		
	<p>Press to turn the meter on or off.</p>		<p><i>In the measurement screen:</i> Press to switch between modes.</p> <p><i>In the setup screen:</i> Press to confirm the selection.</p>
	<p>Press to enter the calibration mode.</p>		<p>Press to enter the setup mode.</p>
<p>store</p> 	<p><i>In the measurement screen:</i> Press to store the data on the screen in continuous read mode and with data logging on.</p> <p><i>In the setup screen:</i> Press to scroll up in the list of options.</p>	 <p>recall</p>	<p><i>In the measurement screen:</i> Press to see the stored data.</p> <p><i>In the setup screen:</i> Press to scroll down in the list of options.</p>

Meter Maintenance

For routine meter maintenance, dust and wipe the meter with a damp cloth. If necessary, warm water or a mild water-based detergent can be used. Meter maintenance can be performed on a daily, weekly or monthly basis, as required by the environment in which the meter is operated. Immediately remove any spilled substance from the meter using the proper cleaning procedure for the type of spill.









This page intentionally left blank.

Chapter 3 Meter Setup





Pressing  will take you to the setup menu.

Navigating the Setup Menu

A complete chart showing the main setup levels and submenus is shown after these steps.

1. In the setup menu, press  or  until the desired main setup level is shown on the top (secondary display) line.
2. Press  to enter into the submenu options.
 - 1.0 Configuration
 - 5.0 Datalog Clear
 - a. Press  or  until the desired submenu is shown.
 - b. Press  to enter into the submenu.
 - c. Press  or  until the desired option is shown.
 - d. Press  to save your selection.





For main setup options with one submenu:

- 2.0 General Meter Setup
 - 3.0 Temperature Settings
 - 4.0 Read Type
 - 6.0 Calibration Data
 - 7.0 Factory Reset
 - a. Press  or  until the desired option is shown.
 - b. Press  to save your selection.
4. Press  to exit the setup menu and return to measurement mode.

Setup Menu Level	Secondary Display	Primary Display	Description	Information
Main	1.0	CONF	Configuration	Select temperature coefficient, TDS factor, cell constant and reference temperature information.
Submenu	COEF	0.0 to 10.0	Linear Temperature Compensation Coefficient	2.1 is the default.
Submenu	TDSF	0.00 to 10.00	TDS Factor	0.49 is the default.
Submenu	CELL	0.001 to 10.00	Conductivity Cell Constant	Used for conductivity automatic calibration with a Thermo Scientific Orion conductivity standard. Default is 0.475.
Submenu	TREF	20.0, 25.0	Conductivity Reference Temperature	25.0 is the default.
Main	2.0	GEN	General Meter Setup	Automatic meter shut-off
Submenu	AUTO	ON, OFF	Automatic Meter Shut-Off	To save battery life, the meter will turn off after 15 minutes without button presses. On is the default setting.
Main	3.0	TEMP	Temperature Settings	Select temperature units and the temperature used for manual temperature compensation
Submenu	UNIT	DEGC, DEGF	Temperature Unit	The default setting is for temperature readout to be displayed in °C.
Submenu	DEGC or DEGF	-5.0 to 105.0	Manual Temperature Compensation Value	This value is used when there is no ATC probe connected, and can be set with the meter's temperature ranges. The temperature unit for this value will match the temperature unit already selected. The default setting is 25.0°C.
Main	4.0	READ	Read Type	
Submenu	READ	AUTO, CONT	AUTO is for AUTO-READ. CONT is for continuous read.	In AUTO-READ mode, the meter will display the measurement as it stabilizes and lock and hold the measurement when it is stable. Press  to take a new measurement. In Continuous read mode, the meter will continuously measure and update the display. The unit of measure will flash. When the reading has been stable, "READY" will stop flashing. The default setting is AUTO-READ.
Main	5.0	LOG	Datalog Clear	
Submenu	DATA	ON, OFF	To enable data storage	The default is off.
Submenu	DEL	LAST, ALL, NO	Clears stored readings in the datalog.	The default is no. "NO" does not delete any readings. "LAST" deletes only the last reading. "ALL" deletes all of the logged data.
Main	6.0	CAL	Calibration Data	
Submenu	CLR	NO, YES	Clears the calibration data.	The default is no.
Main	7.0	RST	Factory Reset	
Submenu	RST	NO, YES	Returns all meter settings to the factory defaults and deletes all stored data (calibration and datalog).	The default is no. Before selecting yes, please make sure any data that you would like to keep has been recorded.

Setup Examples

Read Type Selection

1. In measurement mode, press .
2. Press  three times in setup until "4.0" is shown on the top line and "READ" is shown on the lower line. Press .
3. Press  or  to select the measurement mode:



CONT = Continuous

AUTO = AUTO-READ™





Note: In AUTO-READ mode, the meter will display the measurement as it stabilizes and lock and hold the measurement when it is stable. AR and unit of measure will blink until the reading is stable. When the reading is stable it is held on the screen and AR is lit.

Press  to take a new measurement.

In Continuous read mode, the meter will continuously measure and update the display. The unit of measure will flash. When the reading has been stable, "READY" will appear. This read type is useful when performing an experiment that requires continuous measurements to be taken, regardless of the measurement stability.

4. Press  to save configuration and  to return measurement mode.

Entering the Nominal Cell Constant for Conductivity







1. Press  to enter the setup mode.
2. Press  three times to enter the 1.0 configuration menu and the submenu for cell constant.
3. Press  or  to enter the cell constant value to use for automatic calibration.

Note: Holding the button down will make the value change faster.

4. Press  to save configuration and  to return measurement mode.

Adjusting the TDS Factor

The default value is 0.49.

1. In measurement mode, press .
 2. Press  two times ("TDSF" is displayed on the top line).
 3. Press  or  to enter the TDS factor.
- Note:** Holding the button down will make the value change faster.
4. Press  to save configuration and  to return measurement mode.





This page intentionally left blank.

Chapter 4 Calibration and Measurement

Conductivity Calibration and Conductivity/TDS Measurement

Conductivity Calibration

The single-point calibration can be done automatically or manually with your standard. Automatic calibration can be done using Thermo Scientific Orion conductivity standards at 100 $\mu\text{S}/\text{cm}$, 1413 $\mu\text{S}/\text{cm}$ or 12.9 mS/cm .

1. Make sure the conductivity probe is connected to the meter, and the cell constant has been confirmed (or adjusted if needed) in the setup menu.
2. Select the conductivity standard closest to the expected sample conductivity. The meter will use the cell constant value entered in the setup menu for automatic calibration.
3. Rinse the conductivity probe with distilled water, and insert into the standard and stir gently. Press .
4. "CAL" will appear in the upper right of the display. Wait for "READY" to appear.
5. If "AUTO" appears at the top middle of the display. This indicates the automatic calibration mode and the standard was recognized. Press  to view the calculated cell constant and after 2 seconds the meter will proceed to measurement mode.
6. If "MAN" appears at the top next to "CAL", this indicates a manual calibration mode.
 - a. Press  or  to adjust the value to match your standard.
 - b. Press  to view the calculated cell constant and after 2 seconds the meter will proceed to measurement mode.

Conductivity /TDS Measurement

To measure TDS, confirm the TDS factor is correct and adjust if necessary in the setup menu. The same steps below can be followed with the units being mg/L .

1. Press  to display readings in conductivity.



Note: The units will be $\mu\text{S}/\text{cm}$ or mS/cm . The meter will auto-range to select the appropriate unit).
2. Rinse the conductivity probe with distilled water and blot dry. Insert the probe into the sample and stir gently.
3. If the meter is in AUTO-READ mode (meter default), press . If the meter is in continuous read mode, the meter will immediately start taking readings. Record the result and temperature of the sample when "READY" is displayed and the unit of measurement stops blinking.

Note: If in AUTO-READ mode and memory storage is enabled, the reading will automatically be stored when the "AR" appears. If in continuous read mode and memory storage is enabled, press  to store into the meter's memory.
4. Remove the conductivity probe from the sample, rinse with distilled water and blot dry. To continue taking measurements, place the probe into the next sample, stir gently and repeat step 3.
5. When finished measuring all samples, store probe according to the probe instructions.

Temperature Measurement and Calibration

The Orion Star A112 benchtop conductivity and Star A122 portable conductivity meter show temperature on the top, secondary display. To read only temperature and see the temperature on the primary, lower display, follow the instructions below.

Temperature Measurement

1. In the measurement mode, press  to display the temperature value on the primary display. (The temperature value at the top, secondary display will match that of the lower, primary display field.)
2. Rinse with probe with distilled water, blot dry and place into the sample. If the meter is in AUTO-READ mode (meter default), press . If the meter is in continuous read mode, the meter will immediately start taking readings.

Note: If in AUTO-READ mode and memory storage is enabled, the reading will automatically be stored when the "AR" appears. If in continuous read mode and memory storage is enabled, press  to store into the meter's memory.

3. Remove the probe from the sample, rinse with distilled water and blot dry. To continue taking measurements, place the probe into the next sample and repeat steps 2 and 3.
4. When finished measuring all samples, store probe according to probe instructions.



Temperature Calibration

The meter temperature display has a relative accuracy of ± 0.1 °C. Temperature probes may have varying temperature accuracies, usually ± 0.5 °C to ± 2 °C. Use this function only if it is necessary to calibrate the temperature readings. Since the temperature offset calculated during the calibration is applied to all future temperature measurements, recalibrate if a different probe is used.

1. In the measurement mode, press  to display the temperature reading.
2. Rinse the probe and NIST-traceable thermometers with distilled water, blot dry and place into a solution with a known, stable temperature.

Note: It is recommended that two NIST-traceable thermometers be used to measure and verify the temperature of the solution.

Press .

3. Wait for the readings to stabilize (about 5 to 10 minutes) and "READY" to stop flashing. The meter will display the original temperature read by the probe. Press  or  keys to enter the temperature value read by the thermometer.











Note: The calculated offset will be applied to all future temperature readings. To abort, press  to end without saving and return to the measurement mode.

4. When finished, press  to save and end calibration.











Chapter 5 Data Storage and Review

Orion Star A112 benchtop conductivity and Star A122 portable conductivity meters have a 50-point datalog memory.





Automatic Datalog with AUTO-READ™ Mode

1. In measurement mode, press .
2. Press  three times until "4.0" is shown on the top line and "READ" is shown on the lower line. Press .
3. Press  or  to show "AUTO" on the second line. Press  to save selection.
4. Press  to show "5.0" on the top line and "LOG" on the lower line. Press .
5. Press  to show "ON" on the second line. Press .
6. Press  to return to measurement mode. Each time the reading is locked onto the screen with the "AR" icon. The reading will automatically be stored in the datalog.

Manual Datalog with Continuous Read Mode

1. In measurement mode, press .
2. Press  three times until "4.0" is shown on the top line and "READ" is shown on the lower line. Press .
3. Press  or  to show "CONT" on the second line. Press the "Mode/enter" key to save selection.
4. Press  to show "5.0" on the top line and "LOG" on the lower line. Press .
5. Press  to show "ON" on the second line. Press .
6. Press  to return to measurement mode.
7. In the measurement mode, press  to store the reading into the meter's memory.











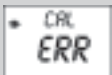

Viewing Stored Readings (the Data Log)

1. In measurement mode, press .
2. Press  or  to scroll through the memory points.
3. Press  to review the reading stored at that point.

This page intentionally left blank.

Chapter 6 Customer Services

Meter Error Codes

Display	Reason	Solution
	Calibrated cell constant is out of range.	The cell constant is not in the range of 0.001 to 199.0 cm ⁻¹ . Clean the conductivity probe according to the probe user guide. Re-calibrate the probe with new standards.
	Memory is full	<p>The meter will automatically change to the submenu to clear the datalog (“CLR” on the top line, “NO” on the second).</p> <p>If the existing memory’s data is still needed:</p> <ol style="list-style-type: none"> 1. Press  to return to the measurement mode and . Record the memory’s data. 2. In measurement mode, press  and then  4 times. (“5.0” appears on the top line.) 3. Press . Press  to delete the last reading or press  to delete all readings. 4. Press  to save the change and delete the data accordingly. <p>If the existing memory’s data can be deleted:</p> <ol style="list-style-type: none"> 1. Press  change to “YES”. 2. Press  to clear the datalog.

Troubleshooting Guide

Problem: The display freezes and the measurement values will not change.

Solution: The meter is in the AUTO-READ measurement mode (the AR icon appears solid on the left of the display).

Press  to start a new reading or select continuous read mode to have readings update constantly.

Problem: How do I abort a calibration?

Solution: Press  abort any meter operation and return to the measurement mode.

Problem: The meter does not recognize the conductivity standard during calibration.

Solution: Verify that the default cell constant was entered in the setup menu. The cell constant is usually printed on the conductivity probe cable. Verify that the conductivity standard is one that is programmed into the meter. Re-calibrate with a fresh standard.

Problem: The measurement is out of range when it should be in range.

Solution: Check that the conductivity probe is fully immersed in the solution. Verify that the cell constant is correct for the conductivity probe that is connected to the meter.

Assistance

After troubleshooting all components of your measurement system, contact Technical Support. Within the United States call 1.800.225.1480 and outside the United States call 978.232.6000 or fax 978.232.6031. In Europe, the Middle East and Africa, contact your local authorized dealer. For the most current contact information, or the latest application and technical resources for Thermo Scientific Orion products, visit www.thermoscientific.com/water.

Warranty and Registration

To register your new meter and for the most current warranty information, visit www.thermoscientific.com/water.

WEEE Compliance



This product is required to comply with the European Union's Waste Electrical & Electronic Equipment (WEEE) Directive 2002/96/EC. It is marked with the symbol above.

Thermo Fisher Scientific has contracted with one or more recycling/disposal companies in each EU Member State and this product should be disposed of or recycled through them. Further information on compliance with these directives, the recyclers in your country, and information on Thermo Scientific Orion products that may assist the detection of substances subject to the RoHS Directive are available at www.thermoscientific.com.

Declaration of Conformity

Manufacturer: Thermo Fisher Scientific Inc.

Address: Ayer Rajah Crescent
Blk 55 #04-16/24
Singapore 139949
Singapore

Hereby declares that the following products:

Benchtop meters are rated 100 to 240 VAC, 50/60 Hz, 0.5A.
Handheld meters use four non-rechargeable AA batteries.

Benchtop Meters

Orion Star A111 pH
Orion Star A112 Conductivity
Orion Star A113 DO

Portable Meters

Orion Star A121 pH
Orion Star A122 Conductivity
Orion Star A123 DO

Equipment Class:

Measurement, control and laboratory
Orion Star A-series meters are EMC Class A

Conforms with the following directives and standards:

EN61326-1:2006

Electromagnetic Compatibility (EMC Directive)

Electrical equipment for measurement,
control and laboratory use - EMC requirements

EN61010-1:2001

UL61010-1:2004

CAN/CSA C22.2 No. 61010-1-04

Safety Standards

Safety requirements for electrical equipment for measurement,
control and laboratory use - general requirements



Cheow Kwang Chan
QA/Regulatory Manager

Place and Date of Issue:
June 15, 2011
Singapore

Meter Specifications

Meter Operating Conditions	
Operating Ambient Temperature	5 to 45 °C
Operating Relative Humidity	5 to 85 %, non-condensing
Storage Temperature	-20 to +60 °C
Storage Relative Humidity	5 to 85 %, non-condensing
Pollution	Degree 2
Overvoltage	Category II
Weight	Portable: 450g Benchtop: 850g
Size	Portable: 5.9 cm (H) x 10.5 cm (W) x 23.1 cm (D) Benchtop: 9.3 cm (H) x 18.0 cm (W) x 23.6 cm (D)
Regulatory and Safety	CE, TUV 3-1, FCC Class A
Power Rating	DC Input: 9 VDC 1A Battery: 4 x AA
Shock and Vibration	Vibration, shipping/handling per ISTA #1A Shock, drop test in packaging per ISTA #1A
Warranty	3 years meter replacement

Universal Power Adapter Operating Conditions	
Operating Ambient Temperature	0 to 50 °C
Operating Relative Humidity	0 to 90 %, non-condensing
Storage Temperature	-20 to +75 °C
Storage Relative Humidity	0 to 90 %, non-condensing
Pollution	Degree 2
Overvoltage	Category II

Meter Parameter Specifications	
Conductivity	
Range	0.1 uS/cm to 200 mS/cm
Resolution	0.01uS Minimum; 3 significant figures minimum
Relative Accuracy	0.5% reading ±1 digit
Reference Temperature	20 °C or 25 °C (default)
Compatible Cell Constants	0.001 to 10.00
Number of Calibration Points	1
TDS	
Range	1 to 19,999 ppm
Resolution	4 significant digits
Relative Accuracy	0.5% reading ±1 digit
TDS Factor Range	Linear 0.01 to 10.00
Temperature	
Range	-5 to 105°C
Resolution	0.1
Relative Accuracy	±0.1
Offset Calibration	1 point
Memory	50 points

Note: Specifications subject to change without notice.

Ordering Information

Benchtop meters include electrode arm.

Kits contain meter, probe and appropriate calibration and fill solutions.

Portable meter kits include a carrying case.

CML #	Description
STARA1110	Orion STAR A111 Benchtop pH Meter
STARA1115	Orion STAR A111 Benchtop pH Meter Kit
STARA1120	Orion STAR A112 Benchtop Conductivity Meter
STARA1125	Orion STAR A112 Benchtop Conductivity Meter Kit
STARA1130	Orion STAR A113 Benchtop Dissolved Oxygen Meter
STARA1135	Orion STAR A113 Benchtop Dissolved Oxygen Meter Kit
STARA1210	Orion STAR A121 Portable pH Meter
STARA1215	Orion STAR A121 Portable pH Meter Kit
STARA1220	Orion STAR A122 Portable Conductivity Meter
STARA1225	Orion STAR A122 Portable Conductivity Meter Kit
STARA1230	Orion STAR A123 Portable Dissolved Oxygen Meter
STARA1235	Orion STAR A123 Portable Dissolved Oxygen Meter Kit
STARA-BEA	Benchtop electrode arm for Orion Star A-series meters
STARA-HB	Freestanding Base for use with Orion Star A-series benchtop electrode arm
STARA-CS	Hard Carrying Case for Orion Star A-series Portable Meters
STARA-AR	Armor for Orion Star A-series Portable Meters, includes electrode holders for pH, conductivity and DO probes
STARA-ESPH	pH Electrode Holder for Orion Star A-series Armor
STARA-ESCD	Conductivity and DO Probe Holder for Orion Star A-series Armor
9157BNMD	Orion Triode 3-in-1 pH/ATC Probe, Refillable, epoxy body
9107BNMD	Orion Triode 3-in-1 pH/ATC Probe, Gel-filled, epoxy body
011050MD	Orion 2-Electrode Conductivity Cell, K=1.0
083005MD	Orion Polarographic DO probe , 1.5m cable

This page intentionally left blank.

Chapter 7 Appendix

Temperature Compensation and Reference Temperature

The Orion Star A112 benchtop conductivity and Star A122 portable conductivity meters have the ability to use a temperature compensation feature that calculates and displays the conductivity measurements at a reference temperature of 20 °C or 25 °C. The closer the sample temperature is to the selected reference temperature, the more accurate the conductivity measurement will be.

The conductivity of a solution with a specific electrolyte concentration changes with temperature and this relationship is described by the temperature coefficient of the solution. The meter has a default temperature coefficient of 2.1 percent change in conductivity per °C, which is representative of many aqueous samples.

Ultra Pure Water	4.55
Salt (NaCl)	2.12
5% NaOH	1.72
Dilute Ammonia	1.88
10% HCl	1.32
5% Sulfuric Acid	0.96
98% Sulfuric Acid	2.84
Sugar Syrup	5.64

Total Dissolved Solids (TDS)

The Orion Star A112 benchtop conductivity and Star A122 portable conductivity meters measure TDS as the total amount of dissolved inorganics in a solution. The dissolved inorganics carry a current that is measured by the conductivity probe. Since there is a direct relationship between conductivity and TDS, conductivity readings are used to estimate the presence of inorganics. The user must enter a TDS factor between 0.01 and 10 mg/L in the setup menu.

The standard method of determining TDS involves evaporating a sample to dryness at 180 °C and weighing the residue. The TDS factor is calculated by taking the residue weight and dividing it by the sample conductivity. Subsequent conductivity readings are multiplied by the TDS factor to determine the TDS value of the sample.

Automatic Conductivity Calibration

The Orion Star A112 benchtop conductivity and Star A122 portable conductivity meters are capable of automatically recognizing 100 µS/cm, 1413 µS/cm and 12.9 mS/cm conductivity standards when the nominal cell constant of the conductivity probe is entered in the setup menu.

Table of Conductivity Standard Values vs. Temperature

Cat. No.	011005	011006	011007	01100910	011008
Temperature (°C)	111.9 mS/cm Conductivity Standard (mS/cm)	12.9 mS/cm Conductivity Standard (mS/cm)	1413 µS/cm Conductivity Standard (µS/cm)	147 µS/cm Conductivity Standard (µS/cm)	100 µS/cm Conductivity Standard (µS/cm)
0	65.10	7.135	776	81	54
1	66.84	7.344	799	83	56
2	68.59	7.555	822	86	58
3	70.35	7.768	846	88	59
4	72.12	7.983	870	91	61
5	73.91	8.200	894	93	63
6	75.70	8.418	918	96	64
7	77.50	8.638	943	98	66
8	79.32	8.860	968	101	68
9	81.15	9.084	992	103	70
10	82.98	9.309	1017	106	72
11	84.83	9.535	1043	108	73
12	86.69	9.763	1068	111	75
13	88.56	9.993	1094	114	77
14	90.45	10.22	1119	116	79
15	92.34	10.46	1145	119	81
16	94.24	10.69	1171	122	83
17	96.15	10.93	1198	125	85
18	98.08	11.16	1224	127	87
19	100.0	11.40	1251	130	88
20	102.0	11.64	1277	133	90
21	103.9	11.88	1304	136	92
22	105.9	12.12	1331	138	94
23	107.9	12.36	1358	141	96
24	109.9	12.61	1386	144	98
25	111.9	12.85	1413	147	100
26	113.9	13.10	1441	150	102
27	115.9	13.35	1468	153	104
28	117.9	13.59	1496	156	106
29	120.0	13.84	1524	159	108
30	122.0	14.09	1552	161	110
31	124.1	14.34	1580	164	112
32	126.2	14.59	1608	167	114
33	128.3	14.85	1636	170	117
34	130.4	15.10	1665	173	119

Cat. No.	011005	011006	011007	01100910	011008
Temperature (°C)	111.9 mS/cm Conductivity Standard (mS/cm)	12.9 mS/cm Conductivity Standard (mS/cm)	1413 µS/cm Conductivity Standard (µS/cm)	147 µS/cm Conductivity Standard (µS/cm)	100 µS/cm Conductivity Standard (µS/cm)
35	132.5	15.35	1693	176	121
36	134.6	15.61	1722	179	123
37	136.7	15.86	1751	182	125
38	138.9	16.12	1780	185	127
39	141.0	16.37	1808	188	129
40	143.2	16.63	1837	191	131
41	145.4	16.89	1866	194	134
42	147.6	17.15	1896	197	136
43	149.8	17.40	1925	200	138
44	152.0	17.66	1954	203	140
45	154.2	17.92	1983	206	142
46	156.4	18.18	2013	209	145
47	158.7	18.44	2042	212	147
48	160.9	18.70	2071	215	149
49	163.2	18.96	2101	219	151
50	165.4	19.22	2130	222	154

Water Analysis Instruments



North America

166 Cummings Center
Beverly, MA 01915 USA
Toll Free: 1-800-225-1480
Tel: 1-978-232-6000
info.water@thermo.com

Netherlands

Tel: (31) 033-2463887
info.water.uk@thermo.com

India

Tel: (91) 22-4157-8800
wai.asia@thermofisher.com

Japan

Tel: (81) 045-453-9175
wai.asia@thermofisher.com

China

Tel: (86) 21-68654588
wai.asi@thermofisher.com

Singapore

Tel: (65) 6778-6876
wai.asia@thermofisher.com

Australia

Tel: (613) 9757-4300
in Australia (1300) 735-296
InfoWaterAU@thermofisher.com
www.thermoscientific.com/water

© 2011 Thermo Fisher Scientific Inc. All rights reserved.

267276-001 Rev. B 07-11