



Thermo Scientific™

Multidrop™ Pico 1 Digital Dispenser

Operating manual

Cat. no. 1509060 Rev. 01

thermo
scientific

Copyright © 2020 Thermo Fisher Scientific Inc. All rights reserved.

Microsoft and Windows are registered trademarks of the Microsoft group of companies.

All other trademarks and registered trademarks are the property of their respective holders.

Thermo Fisher Scientific Inc. provides this document to its customers with a product purchase to use in product operation. This document is copyright protected and any reproduction of the whole or any part of this document is strictly prohibited, except with the written authorization of Thermo Fisher Scientific Inc.

The contents of this document are subject to change without notice. All technical information in this document is for reference purpose only. System configurations and specifications in this document supersede all previous information received by the purchaser.

Thermo Fisher Scientific Inc. makes no representations that this document is complete, accurate or error-free and assumes no responsibility and will not be liable for any errors, omissions, damage or loss that might result from any use of this document, even if the information in the document is followed properly.

This document is not part of any sales contract between Thermo Fisher Scientific Inc. and a purchaser. This document shall in no way govern or modify any Terms and Conditions of Sale, which Terms and Conditions of Sale shall govern all conflicting information between the two documents.

About This User Manual

Warnings and other markings used in the documentation

The following symbols and markings appear in this user manual.



Warning / Caution Risk of injury to the user. Risk of damage to the instrument, other equipment or loss of performance or function in a specific application.



Note Marks a tip, important information that is useful in the optimum operation of the system, or an item of interest.



Tip Gives a helpful hint for getting the most out of the software functionality.

Contents

	About This User Manual.....	3
	Warnings and other markings used in the documentation	3
Chapter 1	Introduction to the Multidrop Pico dispenser.....	7
	How the Multidrop Pico dispenser works.....	7
	Advantages of the Multidrop Pico dispenser	8
Chapter 2	Safety.....	9
	General safety rules.....	9
	Personal protective equipment	9
	Possible inhalation hazard.....	9
	Electrical safety	10
	Electrical emissions safety	10
	Decontamination prior to servicing.....	10
	Safe disposal of cassettes and pipette tips	10
	Ergonomic safety.....	11
	Additional assistance.....	11
Chapter 3	System specifications.....	12
	Intended use	12
	Hardware.....	12
	Environmental operating conditions	12
	Shipping and storage conditions.....	12
	Compatible well plates.....	13
	Additional specifications.....	13
Chapter 4	Understanding the Multidrop Pico dispenser.....	14
	Hardware components	14
	Assembly and startup.....	15
	Adjusting the cassette-to-plate height	17
Chapter 5	Running a protocol	18
	Run/Simulation Window layout – plate and fluid preparation.....	18
	Status area.....	19
	Pause/Abort	19
	Well plate grid display	20
	Plate prompt and loading a plate.....	20
	Loading a plate.....	21
	Cassette prompt and loading a cassette	21
	Loading a cassette.....	22
	Load fluid prompt.....	22
	Modifying load volume	23

	Loading the fluids	24
	Fluid dispensing	26
	Plate changes.....	26
	Cassette changes.....	26
Chapter 6	Preventative maintenance procedures.....	27
	Turning off the Multidrop Pico dispenser	27
	Cleaning the Multidrop Pico dispenser.....	28
	Pogo pin inspection.....	29
	Pogo pin cleaning.....	30
	A1 alignment check.....	30
	Load and validate	31
	Fluid and Dispense.....	32
	Adjust.....	32
	A1 realignment	33
	Preventive maintenance completion form.....	34
	Legal and regulatory notices	35

Chapter 1

Introduction to the Multidrop Pico dispenser

How the Multidrop Pico dispenser works

The Multidrop Pico dispenser provides fast and reliable dispensing performance across a large dynamic range, eliminating slow, wasteful, and error-prone manual serial dilutions and enabling assay miniaturization through low-volume assay component addition.

The Multidrop Pico dispenser provides fast and reliable dispensing across a wide range of life science applications:

- Dose-response curves for small molecule and biomolecule-based drug discovery research
- Drug-drug synergy experiments for drug discovery
- Low-volume assay component dispensing of a wide range of fluids into microplates
- Complex enzyme kinetic studies
- DMPK standards

Using single-use cassettes to help avoid the possibility of cross-contamination, the Multidrop Pico dispenser offers non-contact digital dispensing in the picoliter to microliter range. It combines walk-up convenience, ready-to-run performance and flexible, intuitive experiment design software to increase research productivity, reliability of results, and speed of life science research.

Even the most complex experimental plate layouts, such as drug-drug interaction (synergy) studies, can be made simple. Titrating one drug down the plate while another is titrated orthogonally across the plate enables two or more drug doses to be independently generated in every well. In addition, plate layouts can be randomized to reduce the impact of edge effects, increasing the integrity of the experimental data. The Multidrop Pico dispenser offers a convenient solution to address the most challenging experiments.

The Multidrop Pico dispenser offers non-contact digital dispensing utilizing single-use cassettes to avoid contamination in picoliter to microliter range. It increases research productivity by reliable results provided at higher speed using flexible and intuitive experiment design software.

Advantages of the Multidrop Pico dispenser

The Multidrop Pico dispenser adds breakthrough capability to life science research workflows by offering picoliter-to-microliter non-contact dispensing directly into assay plates.

- **High-Performance Digital Dispensing:** Reliably dispense drop-by-drop from low picoliters to microliters in seconds. Easily complete set-ups even for the most complex experiments such as drug-drug co-titration or enzyme kinetic studies in minutes. Achieve excellent data resolution (0.02 Log Increments). Capable of digitally randomized plate layouts to reduce edge effects and increase data integrity.
- **Resource Savings:** Eliminate slow, error prone, wasteful manual serial-dilution steps. Optimize the use of precious materials and research time. Avoid ergonomic injuries and rework associated with repetitive hand pipetting processes.
- **Ease of Use:** Enjoy a simple, intuitive user experience with quick do-it-yourself experiment design software. Use the Enzyme Profile Wizard to aid in designing complex enzyme kinetic experiments. Boost productivity with walk-up, just-in-time bench top convenience. Avoid carry-over and contamination with single use, non-contact dispensing supplies. The Multidrop Pico dispenser is applicable to many low-volume assay procedures with one system.

Chapter 2

Safety

The Multidrop Pico dispenser should be used in accordance with all applicable safety rules that are in effect in the lab in which it is installed. Use of the Multidrop Pico dispenser should also follow common-sense Multidrop safety guidelines for chemical, mechanical, and electrical safety.



Note If this unit requires servicing, or you are unsure about any aspect of operation or safety, contact the Service Help Desk. The contact information can be found in the Multidrop Pico dispenser *Service and Support* document.



Caution Do not remove any of the Multidrop Pico dispenser covers. Contact your Service Help Desk if the Pico dispenser is not working properly. Do not attempt to repair the Multidrop Pico dispenser yourself.

General safety rules

- Place the Multidrop Pico dispenser on a work surface that supports all four feet securely.
- Plug the Multidrop Pico dispenser into a standard, grounded, electrical outlet. Note the power requirement listed on the back label of the Multidrop Pico dispenser.
- Avoid the moving parts of the Multidrop Pico dispenser during operation.

Personal protective equipment

The safety precautions and personal protective equipment (PPE) specified by your employer for chemicals used and fluid transfer operations and disposal should be used when operating the Multidrop Pico dispenser and handling these materials.

Possible inhalation hazard

The Multidrop Pico dispenser was designed with chemical safety in mind; however, it does dispense picoliter droplets of fluid and generates a small amount (less than 1 %) by volume, of very small aerosol droplets that might not be trapped within the well plate that you are dispensing into. If the fluids are known or suspected to be an inhalation or contact hazard, use the Multidrop Pico dispenser in an enclosure, with an exhaust, such as a lab fume hood.

Electrical safety

The Multidrop Pico dispenser is TUV certified for the CE mark signifying compliance with applicable electrical regulations in the regions where the product is sold. Electrical specifications of the Multidrop Pico dispenser: voltage 100-240V AC, 1 phase/3 wire, 50/60 Hertz, 1.7A full load amperage.



Caution Do not touch the static eliminator electrode probe located under the cover guard. Even if device power is off, directly touching the probe may result in personal injury, electrical shock, or malfunction.

Electrical emissions safety

The Multidrop Pico dispenser has passed an FCC/EMC test for electrical emissions safety. This device complies with part 15 of the FCC Rules. Operation is subject to the following two conditions:

1. This device may not cause harmful interference, and
2. This device must accept any interference received, including interference that may cause undesired operation.

Any changes or modifications to this equipment not expressly approved by Thermo Fisher Scientific may cause harmful interference, and it would void your warranty.

This equipment has been tested and found to comply with the limits for a Class A digital device, pursuant to part 15 of the FCC Rules. These limits are designed to provide reasonable protection against harmful interference when the equipment is operated in a commercial environment. This equipment generates, uses, and can radiate radio frequency energy and, if not installed and used in accordance with the instruction manual, may cause harmful interference to radio communications. Operation of this equipment in a residential area is likely to cause harmful interference in which case users will be required to correct the interference at their own expense. This Class A digital apparatus also complies with Canadian ICES -003.

Decontamination prior to servicing

Service personnel may require you to certify that appropriate cleaning, decontamination, and other abatement of potential threats to service personnel have been performed prior to shipping the Multidrop Pico dispenser for servicing. Recommended cleaning and decontamination procedures are described in the Cleaning the Multidrop Pico dispenser section.

Safe disposal of cassettes and pipette tips

Disposal of used pipette tips and cassettes should be performed in accordance with your company's chemical waste procedures. The DHCs do not require any special disposal procedures except for those required for the chemicals, which have been placed in them, by your laboratory.

Ergonomic safety

The Multidrop Pico dispenser typically requires a single manual pipetting operation for each dispensed compound. In most situations, using the Multidrop Pico dispenser in the intended manner decreases the frequency of shoulder, arm, and wrist motions and so decreases the stress on these joints compared to traditional methods.

To minimize ergonomic risks associated with the use of the Multidrop Pico dispenser, consider the following work area design ideas:

- Place the Multidrop Pico dispenser on a work bench at a height that allows for proper visual and physical access for operators. Having the Multidrop Pico dispenser too high can lead to greater shoulder elevation when pipetting into the cassette and having the Multidrop Pico dispenser too low can lead to increased neck and back flexion.
- If an operator is too short to comfortably access the Multidrop Pico dispenser, consider moving the Multidrop Pico dispenser to a lower bench height. Alternatively, use a footstool or high lab stool that adjusts to the proper work height.
- Place the Multidrop Pico dispenser close to the front of the work surface to minimize the distance the operator must reach to pipette into the cassette.
- Place the pipette tip disposal receptacle close to the Multidrop Pico dispenser.
- Place the computer keyboard close to the Multidrop Pico dispenser to minimize reach distance.
- Adjust the computer monitor height and screen angle for good physical and visual access during Multidrop Pico dispenser operation.
- Perform data analysis at a separate ergonomically designed workstation whenever possible rather than at the Multidrop Pico dispenser computer.

Additional assistance

Contact the Service Help Desk for additional assistance. The contact information can be found in the Multidrop Pico dispenser *Service and Support* document.

Chapter 3

System specifications

Intended use

The Multidrop Pico dispenser and cassettes are intended only for the following uses, wherein all three conditions must be met:

- Dispensing of DMSO solvent or water containing surfactant with or without small molecule compounds or biomolecule(s).
- For general laboratory use.
- Single-usage (i.e., non-reusable) operation of a cassette.

In addition to the requirement of Intended Use, the products should not be used for any of the following: (a) applications in Bio Safety Level 3 or 4 (BSL-3 or-4), food, animal or human testing or therapeutic delivery (except solely for therapeutic delivery for in vitro research uses) (b) dispensing cells, biofluids (unless otherwise specified on product packaging), bacteria, viruses, pathogens, contagions, infectious agents, toxins, oncogenes, or radioactive substances; and (c) in uses that are unsafe, bypassing any product safety features, and/or disobeying any safety instruction.

Hardware

- Dimensions of Multidrop Pico dispenser (W x D x H): 38.5cm x 28cm x 19cm
- Grounded electrical outlet
- 100-240V
- USB port

Environmental operating conditions

- Temperature: 20°C - 30°C laboratory conditions (68 - 86°F)
- Humidity: 30% - 80% RH

Shipping and storage conditions

- Temperature: 10°C - 32°C (50°F – 90°F)
- Humidity: 20% - 80% RH

Compatible well plates

Well plates that meet the following criteria are compatible with the Multidrop Pico dispenser.

- One of the following types: 12, 24, 48, 96, 384 well format.
- Meet ANSI specifications for footprint dimensions and well locations, if applicable.
- Between 4mm and 47mm in height.

Additional specifications

See the Multidrop Pico dispenser *Software User Guide* for more system specifications.

Chapter 4

Understanding the Multidrop Pico dispenser

Hardware components

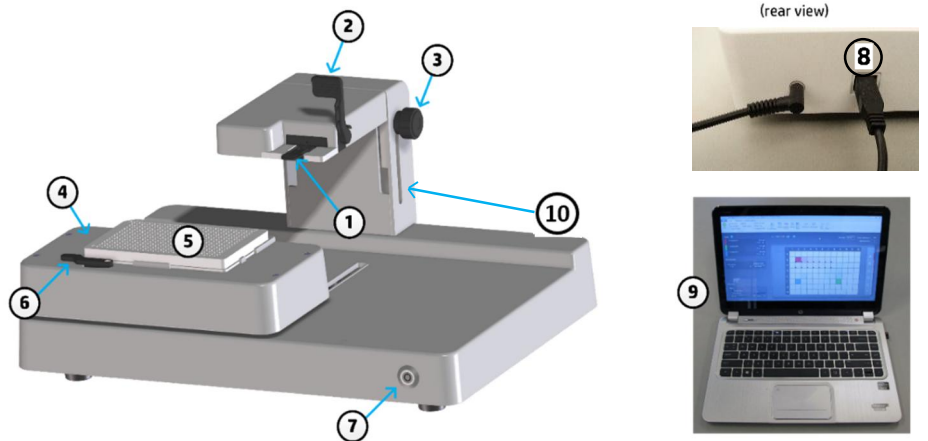

1. Cassette
2. Cassette clamp
3. Plate height adjustment lock
4. Motorized stage and destination plate holder
5. Destination plate
6. Plate clamp
7. Power switch and indicator light
8. Power and USB connections
9. PC with Multidrop Pico dispenser software
10. Cassette holder

Assembly and startup



The Multidrop Pico dispenser runs on standard AC power, between 100-240V.

Warning Be sure the Multidrop Pico dispenser power requirements match your outlet voltage. The voltage requirement is shown on the power supply label. Do NOT plug the power supply into the incorrect voltage. If the labeled voltage on the power supply does not match your standard outlet, contact the Service Help Desk. The contact information can be found in the Multidrop Pico dispenser *Service and Support* document.

An electrical outlet is required for the computer connected to the Multidrop Pico dispenser. A dedicated circuit is not required as the Multidrop Pico dispenser draws less than two amps.

The Multidrop Pico dispenser requires a level bench space which is at least 40 cm (16 inches) wide, 32 cm (13 inches) deep, and 23 cm (9 inches) high. This does not include space for the required computer.

Warning Do not place items other than microplates on the top surface of the Multidrop Pico dispenser.

- Unpack the Multidrop Pico dispenser.
- Connect the power cord (packaged separately) to the back of the Multidrop Pico dispenser (see below, left).
- Plug the other end of the power cord into the appropriate power outlet.
- Turn the Multidrop Pico dispenser on by depressing the main power switch on the front of the Multidrop Pico dispenser.
- The power switch will illuminate and the LED will flash, indicating the beginning of the Multidrop Pico dispenser initialization routine.
- Use the USB cable that came with the Multidrop Pico dispenser to connect the computer to the Multidrop Pico dispenser. The USB port is on the back of the Multidrop Pico dispenser (see below, right).

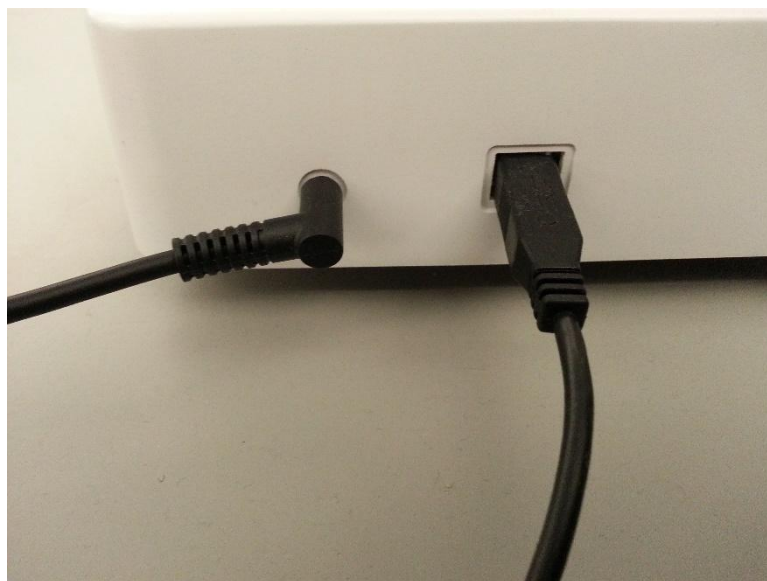

Adjusting the cassette-to-plate height

It is important to set the height of the cassette above the well plate so that it clears the well plate and dispenses optimally.

Turn off the Multidrop Pico dispenser.

Place a well plate on the destination plate holder and move it under the cassette holder.

Use a cassette as a spacer by placing it directly on the well plate. The cassette should be placed as shown below.

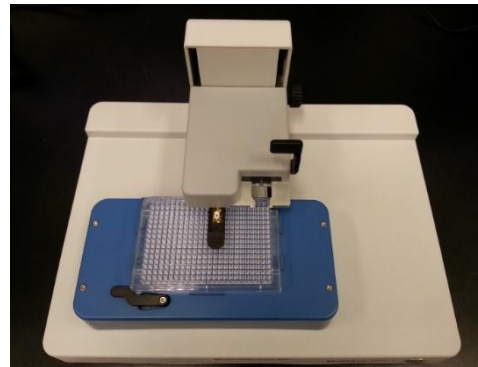
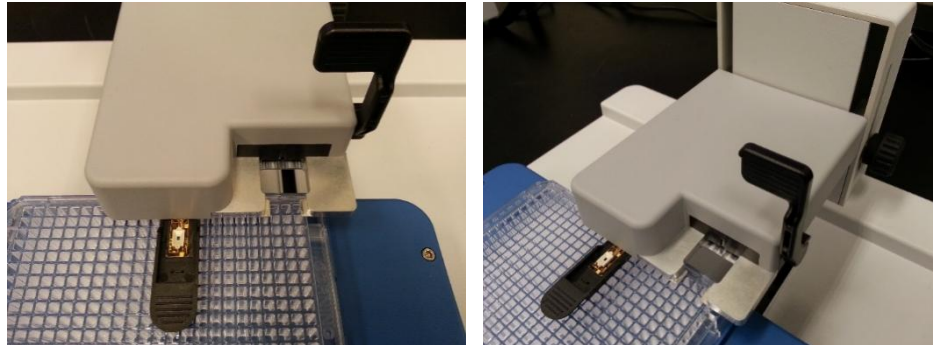

Loosen the adjustment knob and lower the cassette holder until it touches the cassette. The space should be ~ 1.25 mm. Gently tighten the knob and remove the cassette.

The height adjustment can also be made at protocol runtime before the actual dispensing or during A1 alignment check before actual dispensing.

Chapter 5

Running a protocol

Refer to the Multidrop Pico dispenser *Software User Guide* for information about initiating and completing a protocol run.

Run/Simulation Window layout – plate and fluid preparation

In this phase of the run, you load the plate, cassette, and fluids as prompted.

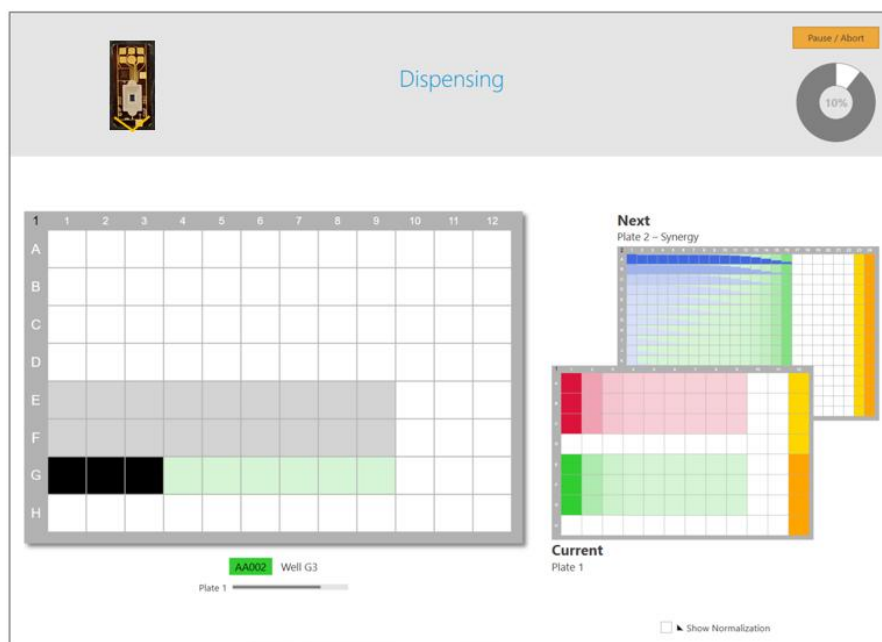

Initially, you will be prompted for both plate and cassette load. Plate and cassette load regions will be displayed as needed during the run. You have the opportunity to adjust the cassette-to-plate height during the run before starting the actual dispensing.

The Simulation Speed bar is displayed if you are running a simulation. Use the bar to adjust the progress speed of the dynamic display of fluids as they are being dispensed. You can adjust the simulation speed at any time during the simulated run.

Fluid dispensing begins when the plate and cassette are loaded and fluid reservoir has been filled for dispensing.

The sections of the Run Window for this phase are:

Status area

The upper portion shows a “status” display area, indicating Waiting on Operator for plate and fluid preparation. There is also a progress circle that lets you know how far along the protocol run is.

Additionally, a Pause/Abort button is available for the balance of the run. If you want to quit the run, you must click this button to leave the run before completion – you cannot exit by clicking the X in the upper right corner of the window.



Note A run can be paused by either using the Pause/Abort button or staying in the Waiting on operator state. Pausing for long periods during a run is not recommended. If the USB connection to the Multidrop Pico dispenser is lost, the protocol cannot be resumed. Various PC settings can influence how quickly an idle PC will disconnect from hardware.

Pause/Abort

Click **Pause/Abort** to pause or abort the run while dispensing is occurring. After you click Pause/Abort, click **Resume** to proceed with the just-paused run (below left) or **Abort** to terminate it.

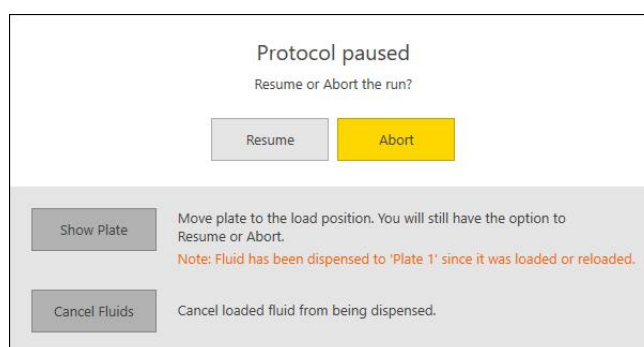

When appropriate, additional options will be offered.

Show Plate will move the plate to where it can be examined by the operator. Resume will return the plate to the dispense area and continue dispensing.

Cancel Fluids allows un-dispensed fluid to be re-planned using a new cassette. This may be used if an incorrect fluid has been loaded into the cassette.

Warning status messages may be displayed for both Show Plate and Cancel Fluids.

Well plate grid display

The current plate is displayed in the Well plate grid. However, the tools and functions of the Main Operating Window are not available. Nevertheless, you can move your cursor over the wells on the monitor screen to see the well summary information. Once dispensing begins the Well plate grid shows the dispense progress as fluids are dispensed into the wells.

Plate prompt and loading a plate

Load Plate 1

Plate ID (optional)

This box prompts you to load the plate and then click **Loaded** (or F6) once you have done so.



Note If the plate load sequence is not strictly sequential, Note plate number messages will be displayed as a reminder to load the correct plate.

If the plate has an identification code you want to track, scan the bar code on the plate using a USB bar code reader attached to your computer, or enter its identification number manually into the Plate ID (optional) field.



Note If **Require and validate plate ID** option has been selected in Run Settings, you must enter a Plate ID and re-enter that ID each time the plate is re-loaded so it can be validated.

Loading a plate

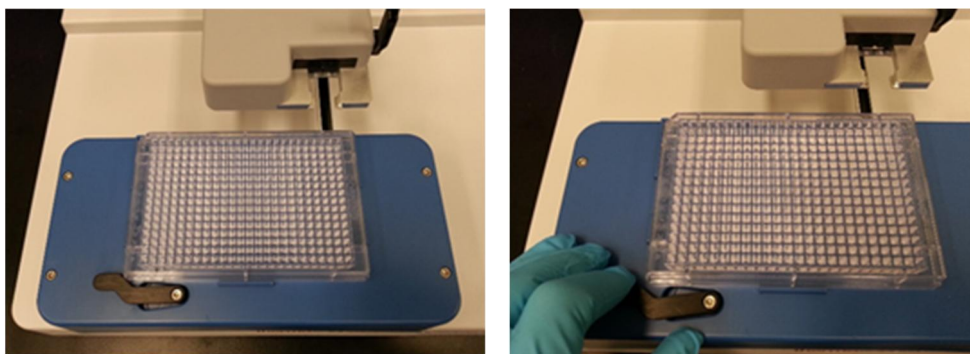

Pull back on plate clamp lever and place the well plate on the plate holder. Ensure the plate sits within the metal guides on all sides. Release the plate clamp lever to secure the plate.

- Make sure the plate is completely level and down on the destination plate holder.
- Ensure that the **A1 well position** (upper-left-most well in the grid) is at the top-left corner of the destination plate holder.

Click **Loaded** (or F6) to proceed.

Cassette prompt and loading a cassette

When a cassette is required, a Cassette Load prompt is displayed, indicating the type of cassette required.



Load a cassette



Load a cassette

Loading a cassette

When prompted, load a cassette as shown.

- If a used cassette is in the Multidrop Pico, release the cassette clamp (put the handle in the 'up' position) and remove the cassette by pulling it horizontally toward the front of the dispenser.
- With the handle in the 'up' position, insert a new cassette by pushing a new cassette into the cassette holder horizontally towards the back of the dispenser.
- Clamp the cassette by rotating the clamp lever handle downward.

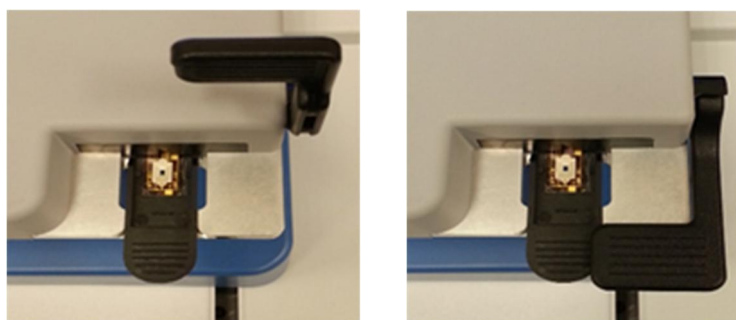

Once you have confirmed that the cassette has been clamped, the dispenser will detect that it has been loaded and will validate the cassette.

If the cassette was used in a previous run, the software program will show the cassette as **used**.

Load fluid prompt

After the cassette has been loaded, the Load Fluid prompt will appear. The prompt has an entry for fluids used in the protocol, color-coded and number-coded (in concert with the numbered cassette reservoirs) with stock concentration and the required load volume.



Fill the cassette reservoir (see [Loading fluid](#) for the description of the physical loading). At this point, the software is waiting for you to fill the reservoir and then indicate that the reservoir has been filled by clicking **Filled** (or Enter). When you click **Filled**, dispensing of that fluid will proceed.



Note The Load Volume quantity of the Load Fluid prompt will always be greater than the amount of fluid requested to be dispensed. The volume to be dispensed for each fluid is labeled as the Total Volume in the right-hand column of Fluid list on the Main Operating Window. The difference between the dispense volume and the load volume is to account for the dead volume, the fluid which is retained in the dispensehead after dispensing. The dead volume is dependent upon the dispense volume and fluid class, with greater dispense volumes and certain fluid classes having greater dead volumes. The minimum load volume ensures proper priming of the dispenseheads (see [Appendix E – Dispense Specifications](#) in the dispenser [Software User Guide](#)).

Modifying load volume

The load volume, which is included in reports, can be modified at the fluid prompt to match the actual volume to be loaded. Load volumes can only be increased from the required amount.

To modify load volume, move the cursor over the volume on the monitors and click when highlighted. A popup box allows the dispensehead volume to be modified.

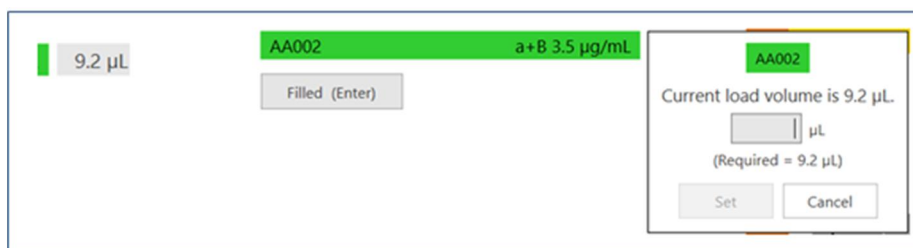

Loading the fluids

Fill an E1-ClipTip electronic pipette with at least the amount of fluid that is indicated in the Load Fluid prompt, or fill a multichannel E1-ClipTip with the appropriate number of fluids in the proper order as shown in the Load Fluid prompt.

E1 Pipette	Description	Cassette compatibility
4670020BT	E1-ClipTip Single channel, 2-125 μ L	LTR0001, LTR0004
4670030BT	E1-ClipTip Single Channel, 10-300 μ L	LTR0002, LTR0003
4672030BT	E1-ClipTip Equalizer 384, 8-ch 1-30 μ L	LTR0004

E1-ClipTip electronic pipette compatibility chart.

Load fluid into the dispensehead when prompted.



Insert the pipette tip directly into the opening.

Do NOT depress the plunger to the second “blow out” stop.



Note Make sure to load the fluid into the opening on top of the dispensehead by placing the pipette tip in the opening and expelling the fluid as shown above. Do NOT depress the pipette plunger to the second “blow out” stop because this could introduce air into the dispensehead.

Examples of good and bad load on **low-volume cassettes**:

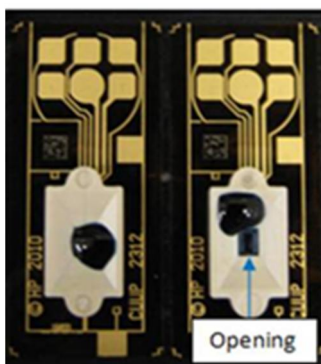

Good load Bad load

When loading a **high-volume cassette**, position the pipette tip in the slot at bottom/left side of the fluid reservoir. Pipette slowly to prevent fluid from spilling out of reservoir.

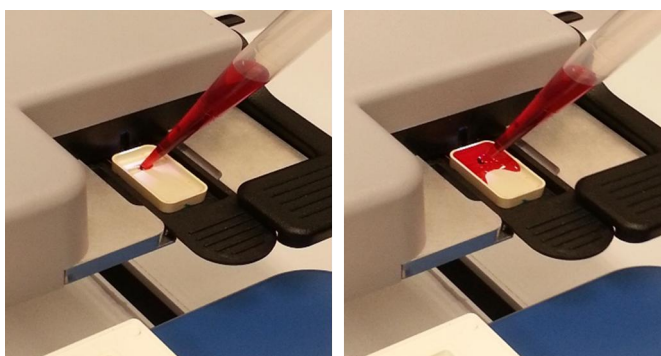

Insert the pipette tip directly into the opening.

Do NOT depress the plunger to the second “blow out” stop

Examples of good and bad load on **high-volume cassettes**:



Good load



Bad load

Fluid dispensing

Once you click **Filled**, dispensing of the fluid is initiated and the dynamic display of the protocol dispensing begins. In the Status Area, the status says **Dispensing** and the progress circle begins to advance.

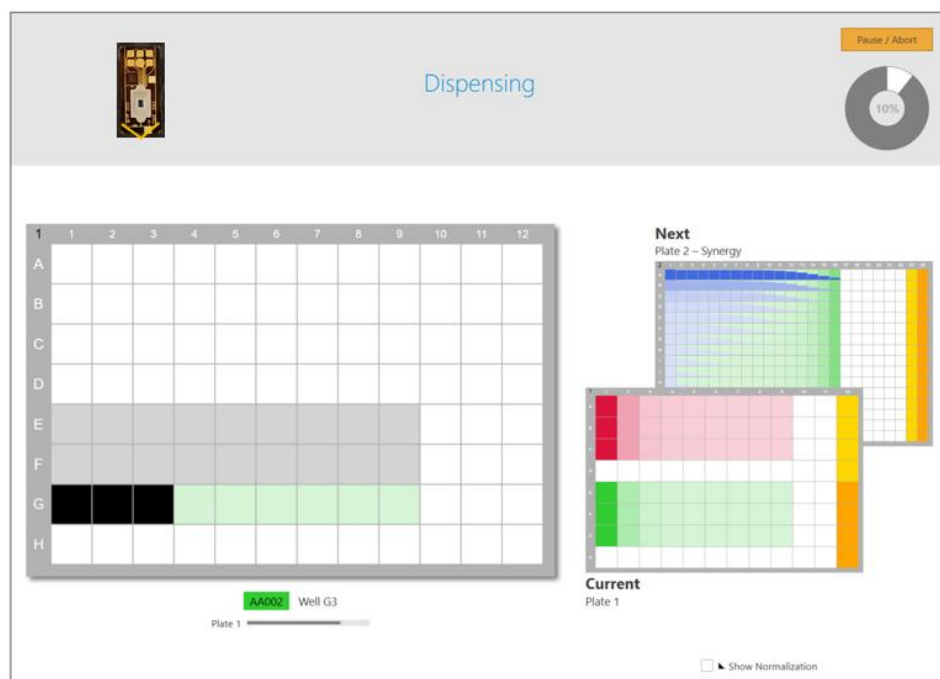

The lower area shows a larger view of the fluid being dispensed, with additional fluid and well information. As dispense is completed for a well, it changes to black. There is a small plate progress bar which indicates progress for all fluids on the current plate.

The **current dispense plate** is shown at the right, along with the **next dispense plate**.

The run continues until all fluid has been dispensed to all plates.

Plate changes

If the protocol has more than one plate, dispensing will pause when a different plate is required, and you will be prompted to change the plate.



Note You may need to load a plate more than once, and plates will not always be requested in order.

Cassette changes

As additional cassettes are needed, dispensing will pause and, you will be prompted to load a new cassette and the fluid needed for that cassette.

Chapter 6

Preventative maintenance procedures

This section describes Multidrop Pico dispenser preventative maintenance. Detailed instructions for each (PM) procedure are described, and a form is provided at the end to document PM completion. The completed PM form can be printed for record keeping.

Unlike many other types of laboratory equipment, there are no electrical or mechanical preventative maintenance adjustments or procedures required. The consumable supply which provides the dispense performance is used just one time prior to disposal. If dispense results are not satisfactory, the instrument will likely need to be returned for repair. Contact information can be found in the *Service and Support* document, which can be accessed from the **File --> Documentation** menu in the Multidrop Pico dispenser software.

Turning off the Multidrop Pico dispenser

Once you have finished using the Multidrop Pico dispenser and will not use it again for an extended period of time, turn it off as follows:

- Close the Multidrop Pico dispenser software, either by clicking the **X** in the upper right corner of the main operating window or by clicking **Exit** in the File Menu.
- Turn the Multidrop Pico dispenser off using the main power switch on the front of the Multidrop Pico dispenser. Depress and hold the power button until the light and power are off.
- Unplug both the power cable and USB cable from the back of the Multidrop Pico dispenser.

Remove any unused cassettes from the Multidrop Pico dispenser to avoid contamination from cleaning solutions or the laboratory environment, and place them back in the cassette tray.

Clean the Multidrop Pico dispenser according to the cleaning procedures described in the Cleaning the Multidrop Pico dispenser section below.

Cleaning the Multidrop Pico dispenser

As with any lab instrument, it is a best practice to routinely clean areas of the Multidrop Pico dispenser that come into contact with chemicals.



Warning Observe the following cautions when cleaning the Multidrop Pico dispenser:

- Do not spray cleaning fluid directly onto the Multidrop Pico dispenser when a cassette is installed. Always avoid exposing unused cassettes to cleaning fluids.
- Do not spray or wipe the ionizer bar that is mounted under the deck to the right of the cassette location.
- Do not spray or wipe the sensors under the Multidrop Pico dispenser deck. Doing so could cause the sensors to become misaligned.

Close the Multidrop Pico software, either by clicking the **X** in the upper right corner of the main operating window or by clicking **Exit** in the File Menu.

Turn off the Multidrop Pico.

Turn off the Multidrop Pico dispenser and remove the power and USB cables from the back of the Multidrop Pico dispenser.

Remove any unused cassettes from the Multidrop Pico dispenser to avoid contamination from cleaning solutions or the laboratory environment and place them back in the cassette tray.

Spray a cleaning solution, such as bleach or a 70% ethanol solution, onto a fabric Texwipe or other cloth that does not generate particles.

Wipe down all accessible Multidrop Pico dispenser surfaces, including the following:

- The top and bottom surfaces of the Multidrop Pico dispenser deck, avoiding the ionizer bar in the cutout on the right side of the bottom of the deck and the sensors at the front corners of the bottom of the deck.
- The destination plate holder.

- The top surface of the bottom cover, below the destination plate holder.
- All the outside surfaces of the Multidrop Pico dispenser.

Clean the pogo pins (see [Pogo pin cleaning](#)).

Pogo pin inspection

For both the pogo pin inspection and cleaning, turn off the Multidrop Pico dispenser:

- Close the Multidrop Pico dispenser software, either by clicking the X in the upper right corner of the main operating window or by clicking Exit in the File Menu.
- Turn off the Multidrop Pico dispenser.

Remove any unused cassettes from the Multidrop Pico dispenser to avoid contamination and place them back in the cassette tray.

Place the handle in the down position to lower the pogo pins down.

Carefully, tip the dispenser on its back to be able to see under the cassette holder.

Inspect the pogo pins through the slot in the cassette holder and ensure that all pogo pins are not bent and extend fully. Pogo pins that are bent or not fully extended must be replaced (contact Support).

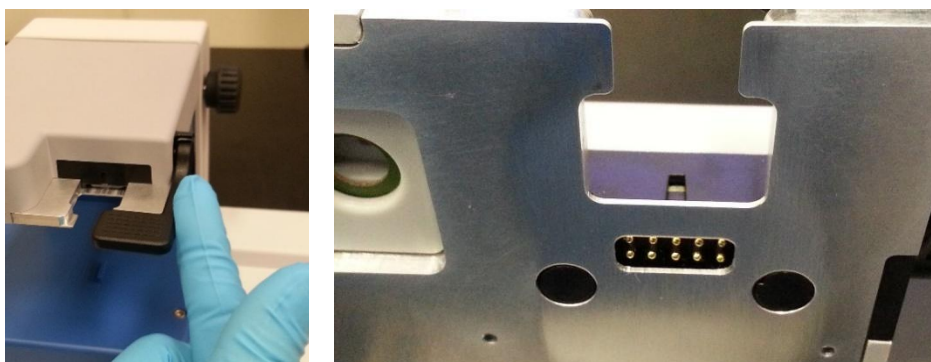

Tip the dispenser back upright and plug the cables back in.

Pogo pin cleaning

If a cassette is in the cassette holder, remove the cassette. Place the handle in the down position to lower the pogo pins. Very gently, in order to not to bend the pogo pins, wipe the pogo pins with a non-fibrous cloth, such as a Texwipe, saturated with isopropyl alcohol. A foam-tipped applicator can also be used, but do not use a fibrous one, like a cotton swab.

- Do not spray the pogo pins with cleaning fluid.
- Do not wipe the pogo pins with cleaning fluid other than isopropyl alcohol.

After wiping the pogo pins, return the handle to the 'up' position. Allow the isopropyl alcohol to dry prior to next use.

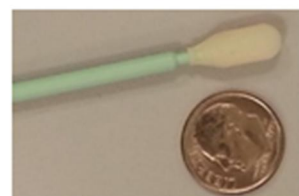
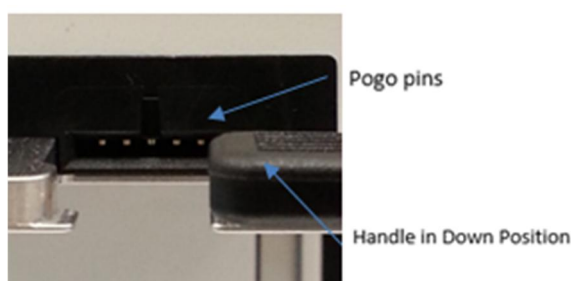

Warning Pogo pins are easily damaged by side pressure. Be careful not to bend them.

A1 alignment check

During shipment or movement of the Multidrop Pico dispenser, it is possible the position of the stage assembly relative to the cassette may change. After re-locating the Multidrop Pico dispenser, you can follow this procedure to test and modify the alignment of stage assembly to cassette. If you notice poor CVs or fluids dispensed on side walls or ribs of the destination plates you may also want to test alignment.

Please use this section only if you are comfortable with resetting computer parameters for instruments such as the Multidrop Pico dispenser. If you are unsure about this procedure at any point, call the Service Help Desk for assistance. The contact information can be found in the Multidrop Pico dispenser *Service and Support* document.

1. Click **A1 Alignment** on the Advanced tab of the ribbon. The A1 Alignment dialog opens as shown below. Select the **well plate** type that you are aligning.

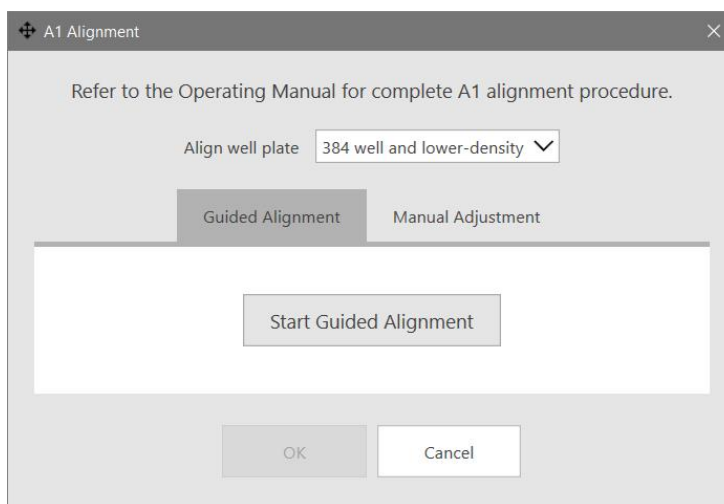

2. Click on **Start Guided Alignment** to be guided through the verification and (optional) alignment process. To skip guided alignment, select the Manual Adjustment tab to adjust the dispense location.

Load and validate

A cassette and plate are loaded in the first step. Any type of cassette can be used for alignment. Place a clear lid or plate seal on the plate.

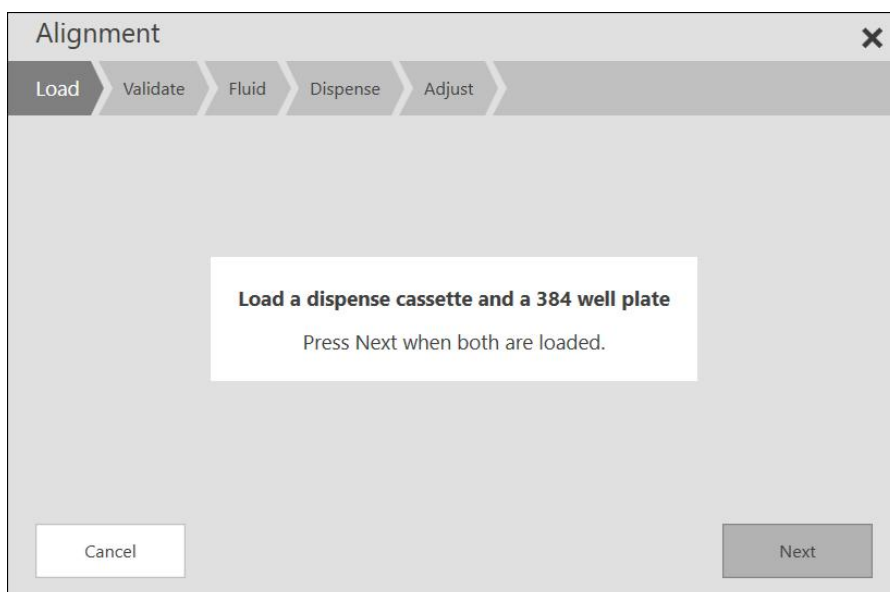

After the cassette and plate are loaded, click **Next** and they will be validated. If necessary, you will be prompted again for cassette and/or plate load.

Fluid and Dispense

DMSO or an aqueous fluid with surfactant can be used for dispensing. Colorant (not more than 10% food coloring in DMSO) may be added to the fluid to make it easier to verify alignment.

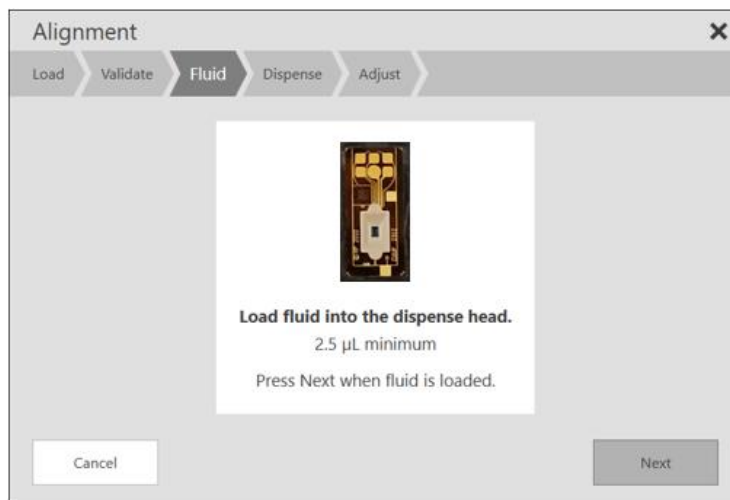

After loading the fluid and clicking **Next**, fluid will be dispensed to the centers of the 4 corner wells.

Adjust

After dispensing, the plate will be moved to a position where it can be examined or removed for closer examination.

If the alignment is correct, you can simply exit the procedure by clicking the **Close** button.

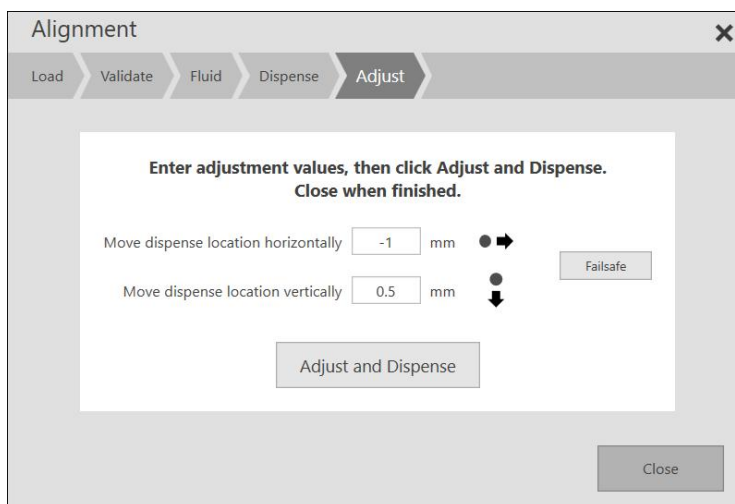

A1 realignment

If the dispense alignment is not correct, it may be helpful to make a sketch showing where the drop landed relative to the well outline. This will help you to remember which direction the drop landed relative to the center of the well.

Measure the approximate offset of the fluid from the center of the well using a metric ruler. Measure to within about a quarter millimeter, noting the offsets.



Note If the fluid in any one corner is off by more than 1.0 mm in a different direction than the other corners, the stage assembly is not square and you need to contact the Service Help Desk. The contact information can be found in the Multidrop Pico dispenser *Service and Support* document.



In the example above, the alignment is off by about 1 mm horizontally and 0.5 mm vertically. The drop position must be moved to the left and down. Typing a negative number in the entry box moves the drop in the opposite direction to the arrow – that is, either left or up.

Clicking **Adjust and Dispense** will adjust the alignment (as specified) and then dispense to the four corners again. Remember to clean the plate cover or seal before re-dispensing. The usual procedure is to adjust and re-dispense to verify the adjustment until alignment is good.

Preventive maintenance completion form

This page can be printed for record keeping.

Instrument Information
Company/Location:
Instrument Name:
Instrument Serial Number:
Installation Date:
Instrument Building /Floor/ Room: / / /
Multidrop Pico dispenser Software Version:

Preventative Maintenance Procedures	NA	Done
Cleaning the Instrument		<input type="checkbox"/>
Pogo Pin Inspection		<input type="checkbox"/>
Pogo Pin Cleaning		<input type="checkbox"/>
A1 Alignment Check		<input type="checkbox"/>
A1 Realignment	<input type="checkbox"/>	<input type="checkbox"/>

The undersigned confirms that these Preventive Maintenance procedures have been performed:

PM(s) Performed By	Email
Signature	Date

Legal and regulatory notices

Thermo Fisher Scientific is committed to providing our customers with information about the chemical substances in our products as needed to comply with legal requirements such as REACH (Regulation EC No 1907/2006 of the European Parliament and the Council). For a chemical report please contact www.thermofisher.com.

Türkiye Cumhuriyeti: AEEE Yönetmeliğine Uygundur

[English meaning: Republic of Turkey: In conformity with the WEEE Regulation]

This product, as well as its related consumables and spares, complies with the reduction in hazardous substances provisions of the "India E-waste Rule 2016." It does not contain lead, mercury, hexavalent chromium, polybrominated biphenyls or polybrominated diphenyl ethers in concentrations exceeding 0.1 weight % and 0.01 weight % for cadmium, except where allowed pursuant to the exemptions set in Schedule 2 of the Rule.

Disposal of Waste Equipment by Users



English

Disposal of Waste Equipment by Users in Private Households in the European Union

This symbol on the product or on its packaging indicates that this product must not be disposed of with your other household waste. Instead, it is your responsibility to dispose of your waste equipment by handing it over to a designated collection point for the recycling of waste electrical and electronic equipment. The separate collection and recycling of your waste equipment at the time of disposal will help to conserve natural resources and ensure that it is recycled in a manner that protects human health and the environment. For more information about where you can drop off your waste equipment for recycling, please contact your local city office, your household waste disposal service or the shop where you purchased the product.

Français

Evacuation des équipements usagés par les utilisateurs dans les foyers privés au sein de l'Union européenne

La présence de ce symbole sur le produit ou sur son emballage indique que vous ne pouvez pas vous débarrasser de ce produit de la même façon que vos déchets courants. Au contraire, vous êtes responsable de l'évacuation de vos équipements usagés et à cet effet, vous êtes tenu de les remettre à un point de collecte agréé pour le recyclage des équipements électriques et électroniques usagés. Le tri, l'évacuation et le recyclage séparés de vos équipements usagés permettent de préserver les ressources naturelles et de s'assurer que ces équipements sont recyclés dans le respect de la santé humaine et de l'environnement. Pour plus d'informations sur les lieux de collecte des équipements usagés, veuillez contacter votre mairie, votre service de traitement des déchets ménagers ou le magasin où vous avez acheté le produit.

Deutsch

Entsorgung von Elektrogeräten durch Benutzer in privaten Haushalten in der EU

Dieses Symbol auf dem Produkt oder dessen Verpackung gibt an, dass das Produkt nicht zusammen mit dem Restmüll entsorgt werden darf. Es obliegt daher Ihrer Verantwortung, das Gerät an einer entsprechenden Stelle für die Entsorgung oder Wiederverwertung von Elektrogeräten aller Art abzugeben (z.B. ein Wertstoffhof). Die separate Sammlung und das Recyceln Ihrer alten Elektrogeräte zum Zeitpunkt ihrer Entsorgung trägt zum Schutz der Umwelt bei und gewährleistet, dass sie auf eine Art und Weise recycelt werden, die keine Gefährdung für die Gesundheit des Menschen und der Umwelt darstellt. Weitere Informationen darüber, wo Sie alte Elektrogeräte zum Recyceln abgeben können, erhalten Sie bei den örtlichen Behörden, Wertstoffhöfen oder dort, wo Sie das Gerät erworben haben.

Italiano

Smaltimento delle apparecchiature elettriche ed elettroniche a fine vita nell'Unione Europea

Questo simbolo, riportato sull'apparecchiatura o sulla confezione, indica che il prodotto alla fine della propria vita utile deve essere smaltito separatamente dagli altri rifiuti domestici. L'utente dovrà quindi portare l'apparecchiatura giunta a fine vita agli appositi centri di raccolta differenziata per rifiuti elettrici ed elettronici. L'adeguata raccolta differenziata e il successivo riciclo contribuiscono a evitare possibili effetti negativi sull'ambiente e sulla salute e favoriscono la conservazione delle risorse naturali. Per ulteriori informazioni sui punti di raccolta delle apparecchiature a fine vita, contattare il proprio comune di residenza, il servizio di smaltimento dei rifiuti locale o il negozio presso il quale è stato acquistato il prodotto.

Español

Eliminación de residuos de aparatos eléctricos y electrónicos por parte de usuarios domésticos en la Unión Europea

Este símbolo en el producto o en el embalaje indica que no se puede desechar el producto junto con los residuos domésticos. Por el contrario, si debe eliminar este tipo de residuo, es responsabilidad del usuario entregarlo en un punto de recolección designado de reciclado de aparatos electrónicos y eléctricos. El reciclaje y la recolección por separado de estos residuos en el momento de la eliminación ayudará a preservar recursos naturales y a garantizar que el reciclaje proteja la salud y el medio ambiente. Si desea información adicional sobre los lugares donde puede dejar estos residuos para su reciclado, póngase en contacto con las autoridades locales de su ciudad, con el servicio de gestión de residuos domésticos o con la tienda donde adquirió el producto.

Бългaрски	<p>Изхвърляне на отпадъчни уреди от потребители на домакинства в Европейския съюз</p> <p>Този символ на продукта или на опаковката му о бозначава, че продуктът не трябва да се изхвър ля заедно с другите битови отпадъци. Напротив, вашa отговорност е да изхвърлите отпадъчното оборудване до определено място за рециклиран е на електрическо и електронно оборудване. Раз делното събиране и рециклиране на отпадъчно о борудване в момента на изхвърлянето му помага да се съхранят природните ресурси и да се гара нтира, че то ще бъде рециклирано по начин, който предпазва човешкото здраве и околната среда. За допълнителна информация относно местата за предаване на отпадъчното оборудване за рециклиране се свържете с общинската служба, служба та за събиране на битовите отпадъци или магази на, откъдето сте закупили уреда.</p>
Česky	<p>Likvidace vysloužilého zařízení uživateli v domácnosti v zemích EU</p> <p>Tato značka na produktu nebo na jeho obalu označuje, že tento produkt nesmí být likvidován prostým vyhozením do běžného domovního odpadu. Odpovídáte za to, že vysloužilé zařízení bude předáno k likvidaci do stanovených sběrných míst určených k recyklaci vysloužilých elektrických a elektronických zařízení. Likvidace vysloužilého zařízení samostatným sběrem a recyklací napomáhá zachování přírodních zdrojů a zajišťuje, že recyklace proběhne způsobem chránícím lidské zdraví a životní prostředí. Další informace o tom, kam můžete vysloužilé zařízení předat k recyklaci, můžete získat od úřadů místní samosprávy, od společnosti provádějící svoz a likvidaci domovního odpadu nebo v obchodě, kde jste produkt zakoupili.</p>
Dansk	<p>Bortskaffelse af affaldsudstyr for brugere i private husholdninger i EU</p> <p>Dette symbol på produktet eller på dets emballage indikerer, at produktet ikke må bortskaffes sammen med andet husholdningsaffald. I stedet er det dit ansvar at bortskaffe affaldsudstyr ved at aflevere det på dertil beregnede indsamlingssteder med henblik på genbrug af elektrisk og elektronisk affaldsudstyr. Den separate indsamling og genbrug af dit affaldsudstyr på tidspunktet for bortskaffelse er med til at bevare naturlige ressourcer og sikre, at genbrug finder sted på en måde, der beskytter menneskers helbred samt miljøet. Hvis du vil vide mere om, hvor du kan aflevere dit affaldsudstyr til genbrug, kan du kontakte kommunen, det lokale renovationsvæsen eller den forretning, hvor du købte produktet.</p>
Nederlands	<p>Afvoer van afgedankte apparatuur door gebruikers in particuliere huishoudens in de Europese Unie</p> <p>Dit symbool op het product of de verpakking geeft aan dat dit product niet mag worden afgevoerd met het huishoudelijk afval. Het is uw verantwoordelijkheid uw afgedankte apparatuur af te leveren op een aangewezen inzamelpunt voor de verwerking van afgedankte elektrische en elektronische apparatuur. De gescheiden inzameling en verwerking van uw afgedankte apparatuur draagt bij tot het sparen van natuurlijke bronnen en tot het hergebruik van materiaal op een wijze die de volksgezondheid en het milieu beschermt. Voor meer informatie over waar u uw afgedankte apparatuur kunt inleveren voor recycling kunt u contact opnemen met het gemeentehuis in uw woonplaats, de reinigingsdienst of de winkel waar u het product hebt aangeschaft.</p>
Eesti	<p>Eramajapidamistes kasutuselt kõrvaldatavate seadmete käitlemine Euroopa Liidus</p> <p>Kui tootel või toote pakendil on see sümbol, ei tohi seda toodet visata olmejäätmete hulka. Teie kohus on viia tarbetuks muutunud seade selleks ettenähtud elektri- ja elektroonikaseadmete utiliseerimiskohta. Utiliseeritavate seadmete eraldi kogumine ja käitlemine aitab säästa loodusvarasid ning tagada, et käitlemine toimub inimeste tervisele ja keskkonnale ohutult. Lisateavet selle kohta, kuhu saate utiliseeritava seadme käitlemiseks viia, saate küsida kohalikust omavalitsusest, olmejäätmete utiliseerimispunkti või kauplusest, kust te seadme ostsite.</p>
Suomi	<p>Hävitettävien laitteiden käsittely kotitalouksissa Euroopan unionin alueella</p> <p>Tämä tuotteessa tai sen pakkauksessa oleva merkintä osoittaa, että tuotetta ei saa hävittää talousjätteen mukana. Käyttäjän velvollisuus on huolehtia siitä, että hävitettävä laite toimitetaan sähkö- ja elektroniikkalaiteromun keräyspisteeseen. Hävitettävien laitteiden erillinen keräys ja kierrätys säästää luonnonvaroja. Näin toimimalla varmistetaan myös, että kierrätys tapahtuu tavalla, joka suojelee ihmisten terveyttä ja ympäristöä. Saat tarvittaessa lisätietoja jätteiden kierrätyspaikoista paikallisilta viranomaisilta, jätteyhtiöiltä tai tuotteen jälleenmyyjältä.</p>

Ελληνικά	<p>Απόρριψη άχρηστων συσκευών στην Ευρωπαϊκή Ένωση</p> <p>Το παρόν σύμβολο στον εξοπλισμό ή στη συσκευασία του υποδεικνύει ότι το προϊόν αυτό δεν πρέπει να πεταχτεί μαζί με άλλα οικιακά απορρίμματα. Αντίθετα, ευθύνη σας είναι να απορρίψετε τις άχρηστες συσκευές σε μια καθορισμένη μονάδα συλλογής απορριμμάτων για την ανακύκλωση άχρηστου ηλεκτρικού και ηλεκτρονικού εξοπλισμού. Η χωριστή συλλογή και ανακύκλωση των άχρηστων συσκευών θα συμβάλει στη διατήρηση των φυσικών πόρων και τη διασφάλιση ότι θα ανακυκλωθούν με τρόπο ώστε να προστατεύεται η υγεία των ανθρώπων και το περιβάλλον. Για περισσότερες πληροφορίες σχετικά με το πού μπορείτε να απορρίψετε τις άχρηστες συσκευές για ανακύκλωση, επισκεφτείτε τις κατά τόπους αρμόδιες αρχές ή το κατάστημα από το οποίο αγοράσατε το προϊόν.</p>
Magyar	<p>A hulladékok kezelése a magánháztartásokban az Európai Unióban</p> <p>Ez a szimbólum, amely a terméken vagy annak csomagolásán van feltüntetve, azt jelzi, hogy a termék nem kezelhető együtt az egyéb háztartási hulladékkal. Az Ön feladata, hogy a készülék hulladékhanyagait eljuttassa olyan kijelölt gyűjtőhelyre, amely az elektromos hulladékhanyagok és az elektronikus berendezések újrahasznosításával foglalkozik. A hulladékhanyagok elkülönített gyűjtése és újrahasznosítása hozzájárul a természeti erőforrások megőrzéséhez, egyúttal azt is biztosítja, hogy a hulladék újrahasznosítása az egészségre és a környezetre nem ártalmas módon történik. Ha tájékoztatást szeretne kapni azokról a helyekről, ahol leadhatja újrahasznosításra a hulladékhanyagokat, forduljon a helyi önkormányzathoz, a háztartási hulladék begyűjtésével foglalkozó vállalathoz vagy a termék forgalmazójához.</p>
Latviski	<p>Lietotāju atbrīvošanās no nederīgām ierīcēm Eiropas Savienības privātajās mājāsaimniecībās</p> <p>Šis simbols uz ierīces vai tās iepakojuma norāda, ka šo ierīci nedrīkst izmest kopā ar pārējiem mājāsaimniecības atkritumiem. Jūs esat atbildīgs par atbrīvošanos no nederīgās ierīces, to nododot norādītajā savākšanas vietā, lai tiktu veikta nederīgā elektriskā un elektroniskā aprīkojuma atbrīvējā pārstrāde. Speciāla nederīgās ierīces savākšana un atbrīvējā pārstrāde palīdz taupīt dabas resursus un nodrošina tādu atbrīvējo pārstrādi, kas sargā cilvēku veselību un apkārtējo vidi. Lai iegūtu papildu informāciju par to, kur atbrīvējai pārstrādei var nogādāt nederīgo ierīci, lūdzu, sazinieties ar vietējo pašvaldību, mājāsaimniecības atkritumu savākšanas dienestu vai veikalu, kurā iegādājāties šo ierīci.</p>
Lietuviškai	<p>Europos Sąjungos vartotojų ir privačių namų ūkių atliekamos įrangos išmetimas</p> <p>Šis simbolis ant produkto arba jo pakuotės nurodo, kad produktas negali būti išmestas kartu su kitomis namų ūkio atliekomis. Jūs privalote išmesti savo atliekamą įrangą atiduodami ją į atliekamos elektronikos ir elektros įrangos perdirbimo punktus. Jei atliekama įranga bus atskirai surenkama ir perdirbama, bus išsaugomi natūralūs ištekliai ir užtikrinama, kad įranga yra perdirbta žmogaus sveikatai ir gamtą tausojančiu būdu. Dėl informacijos apie tai, kur galite išmesti atliekamą perdirbti skirtą įrangą, kreipkitės į atitinkamą vietos tarnybą, namų ūkio atliekų išvežimo tarnybą arba į parduotuvę, kurioje pirkote produktą.</p>
Polski	<p>Utylizacja zużytego sprzętu przez użytkowników domowych w Unii Europejskiej</p> <p>Symbol ten umieszczony na produkcie lub opakowaniu oznacza, że tego produktu nie należy wyrzucać razem z innymi odpadami domowymi. Użytkownik jest odpowiedzialny za dostarczenie zużytego sprzętu do wyznaczonego punktu zbierania zużytych urządzeń elektrycznych i elektronicznych. Zbieranie osobno i recykling tego typu odpadów przyczyniają się do ochrony zasobów naturalnych i są bezpieczne dla zdrowia i środowiska naturalnego. Dalsze informacje na temat sposobu utylizacji zużytych urządzeń można uzyskać u odpowiednich władz lokalnych, w przedsiębiorstwie zajmującym się usuwaniem odpadów lub w miejscu zakupu produktu.</p>
Portugués	<p>Descarte de equipamentos por usuários em residências da União Européia</p> <p>Este símbolo no produto ou na embalagem indica que o produto não pode ser descartado junto com o lixo doméstico. No entanto, é sua responsabilidade levar os equipamentos a serem descartados a um ponto de coleta designado para a reciclagem de equipamentos eletro-eletrônicos. A coleta separada e a reciclagem dos equipamentos no momento do descarte ajudam na conservação dos recursos naturais e garantem que os equipamentos serão reciclados de forma a proteger a saúde das pessoas e o meio ambiente. Para obter mais informações sobre onde descartar equipamentos para reciclagem, entre em contato com o escritório local de sua cidade, o serviço de limpeza pública de seu bairro ou a loja em que adquiriu o produto.</p>

Română	<p>Scoaterea din uz a echipamentelor uzate de către utilizatorii persoane fizice din Uniunea Europeană</p> <p>Prezența acestui simbol pe produs sau pe ambalajul acestuia indică faptul că nu poate fi aruncat împreună cu gunoiul menajer. În schimb, este răspunderea dvs. să scoateți din uz echipamentul uzat predându-l la punctul de colectare indicat pentru reciclarea echipamentelor electrice și electronice uzate. Colectarea și reciclarea separată a echipamentelor uzate la scoaterea din folosință ajută la conservarea resurselor naturale și asigură reciclarea acestora într-un mod care protejează sănătatea oamenilor și mediul înconjurător. Pentru informații suplimentare despre locațiile în care puteți preda echipamentele uzate pentru reciclare, contactați primăria locală, serviciul de salubritate care deservește gospodăria dvs. sau magazinul de la care ați cumpărat produsul.</p>
Slovenčina	<p>Postup používateľov v krajinách Európskej únie pri vyhadzovaní zariadenia v domácom používaní do odpadu</p> <p>Tento symbol na produkte alebo na jeho obale znamená, že nesmie byť vyhodnený s iným komunálnym odpadom. Namiesto toho máte povinnosť odovzdať toto zariadenie na zbernom mieste, kde sa zabezpečuje recyklácia elektrických a elektronických zariadení. Separovaný zber a recyklácia zariadenia určeného na odpad pomôže chrániť prírodné zdroje a zabezpečiť taký spôsob recyklácie, ktorý bude chrániť ľudské zdravie a životné prostredie. Ďalšie informácie o separovanom zbere a recyklácii získate na miestnom obecnom úrade, vo firme zabezpečujúcej zber vášho komunálneho odpadu alebo v predajni, kde ste produkt kúpili.</p>
Slovenščina	<p>Ravnanje z odpadno opremo v gospodinjstvih znotraj Evropske unije</p> <p>Ta znak na izdelku ali embalaži izdelka pomeni, da izdelka ne smete odlagati skupaj z drugimi gospodinjstvenimi odpadki. Odpadno opremo ste dolžni oddati na določenem zbirnem mestu za recikliranje odpadne električne in elektronske opreme. Z ločenim zbiranjem in recikliranjem odpadne opreme ob odlaganju boste pomagali ohraniti naravne vire in zagotovili, da bo odpadna oprema reciklirana tako, da se varuje zdravje ljudi in okolje. Več informacij o mestih, kjer lahko oddate odpadno opremo za recikliranje, lahko dobite na občini, v komunalnem podjetju ali trgovini, kjer ste izdelek kupili.</p>
Svenska	<p>Kassering av förbrukningsmaterial, för hem- och privat användare i EU</p> <p>Produkter eller produktförpackningar med den här symbolen får inte kasseras med vanligt hushållsavfall. I stället har du ansvar för att produkten lämnas till en behörig återvinningsstation för hantering av el- och elektronikprodukter. Genom att lämna kasserade produkter för återvinning hjälper du till med att bevara våra gemensamma naturresurser. Dessutom skyddas både människor och miljön när produkter återvinns på rätt sätt. Kommunala myndigheter, sophanteringsföretag eller butiken där varan köptes kan ge mer information om var du lämnar kasserade produkter för återvinning.</p>
简体中文	<p>欧盟国家/地区用户在私人住宅中对废旧设备的处理</p> <p>产品或包装上包括此标志表示此产品不得作为住宅垃圾来处理。而且您有责任将废旧设备送到指定的废旧电力电子设备回收点，通过这种方式来处理废旧设备。废旧设备的分类收集与回收有助于节约自然资源，保证以有利于人类健康和环保的方式回收废旧设备。有关废旧设备回收的详细信息，请与当地市政机关、家庭垃圾处理站或购买产品的商店联系。</p>

产品中有害物质或元素的名称及含量
根据中国《电子信息产品污染控制管理办法》

部件名称	有害物质					
	铅 (Pb)	汞 (Hg)	镉 (Cd)	六价 铬 (Cr(VI))	多溴联 苯 (PBB)	多溴二 苯醚 (PBDE)
电缆 / 电线	○	○	○	○	○	○
机壳	○	○	○	○	○	○
消耗品	○	○	○	○	○	○
外壳面板	X	○	○	○	○	○
激光检测仪	○	○	○	○	○	○
媒体 (CD)	○	○	○	○	○	○
电机组件	○	○	○	○	○	○
印刷电路组 件 / 电气元件	X	○	○	○	○	○
电源适配器/ 电源	X	○	○	○	○	○
传感器	○	○	○	○	○	○
静电消除棒	X	○	○	○	○	○

本表格依据SJ/T 11364 的规定编制。
 ○: 表示该有害物质在该部件所有均质材料中的含量均在GB/T 26572 规定的限量要求以下。
 X: 表示该有害物质至少在该部件的某一均质材料中的含量超出GB/T 26572 规定的限量要求。

此表中所有名称中含 表中所有的部件均符合欧盟 RoHS 立法。

注: 环保使用期限的参考标识取决于产品正常工作的温度和湿度等条件

The Table of Hazardous Substances/Elements and their Content

as required by China's Management Methods for Controlling Pollution by Electronic Information Products

Part Name	Hazardous Substances					
	Lead (Pb)	Mercury (Hg)	Cadmium (Cd)	Hexavalent Chromium (Cr(VI))	Polybrominated biphenyls (PBB)	Polybrominated diphenyl ethers (PBDE)
Cable / Wiring	○	○	○	○	○	○
Chassis	○	○	○	○	○	○
Consumable	○	○	○	○	○	○
Outer Cover Panel	X	○	○	○	○	○
Laser Detector	○	○	○	○	○	○
Media (CD)	○	○	○	○	○	○
Motor Assembly	○	○	○	○	○	○
PCA / Electrical Component	X	○	○	○	○	○
Power Adapter / Supply	X	○	○	○	○	○
Sensor	○	○	○	○	○	○
Static Elimination Bar	X	○	○	○	○	○

This form has been prepared in compliance with the provisions of SJ/T 11364

O: Indicates that the content of said hazardous substance in all of the homogenous materials in the component is within the limits required by GB/T 26572

X: Indicates that the content of said hazardous substance exceeds the limits required by GB/T 26572 in at least one homogenous material in the component.

All parts named in this table with an “X” are in compliance with the European Union’s RoHS Legislation.

Note: The referenced Environmental Protection Use Period Marking was determined according to normal operating use conditions of the product such as temperature and humidity.

