



MaxQ SHKE8000 Series

Stackable Orbital Shakers*

Operating and Maintenance Manual 7010443 Rev. 6

Visit us online to register your warranty
www.thermoscientific.com/labwarranty

Thermo
SCIENTIFIC

(from cover)

* Triple counter-balanced, single eccentric drive mechanism (U.S. Patent #5,558,437)

* Horizontal, HEPA-filtered airflow design (U.S. Patent #5,577,837)

* Test Tube Rack (U.S. Patent #5,632,388)

Models covered by this manual

Model	Number	Voltage, Frequency	Temperature Control
SHKE8000	443	120VAC, 60Hz	incubated
SHKE8000-1CE	444	230VAC, 50Hz	incubated
SHKE8000-7	493	120VAC, 60Hz	incubated/refrigerated
SHKE8000-8CE	496	230VAC, 50Hz	incubated/refrigerated

MANUAL NUMBER 7010443

6	41343	05/01/17	Remove certification info, added F-Gas statement	bpg
5	40787	04/18/17	Remove Optional Platform Assy	bpg
4	40769	6/21/16	Updated Maximum Load/Speed in Specifications to Maximum Product Weight	ccs
3	40970	6/8/16	Updated Temperature Specification on pg 5-1 (S. Livingston)	ccs
2	--	7/27/15	Corrected typo in Electrical in Specifications	ccs
1	40139	4/15/15	Updated warranty information	ccs
0	28036/OS-751	9/3/14	Release 3 (new control board)	ccs
REV	ECR/ECN	DATE	DESCRIPTION	By



Important Read this instruction manual. Failure to read, understand and follow the instructions in this manual may result in damage to the unit, injury to operating personnel, and poor equipment performance. ▲

Caution All internal adjustments and maintenance must be performed by qualified service personnel. ▲

Warning Use MaxQ SHKE8000 Series Orbital Shakers to process non-flammable materials only! ▲

Warning Grounding circuit continuity is vital for the safe operation of this shaker. Never operate this unit with the grounding conductor disconnected. ▲

Material in this manual is for information purposes only. The contents and the product it describes are subject to change without notice. Thermo Fisher Scientific makes no representations or warranties with respect to this manual. In no event shall Thermo be held liable for any damages, direct or incidental, arising out of or related to the use of this manual.

When this manual is translated into other languages, the US English version is binding.

©2014 Thermo Fisher Scientific. All rights reserved.



Important operating and/or maintenance instructions. Read the accompanying text carefully.



Potential electrical hazards. Only qualified persons should perform procedures associated with this symbol.



Equipment being maintained or serviced must be turned off and locked off to prevent possible injury.

Hot surface(s) present which may cause burns to unprotected skin, or to materials which may be damaged by elevated temperatures.

WEEE Compliance: Thermo Fisher Scientific has contracted with companies for recycling/disposal in each EU Member State. For further information, send an email to weee.recycle@thermofisher.com.

- ✓ Always use the proper protective equipment (clothing, gloves, goggles, etc.)
- ✓ Always dissipate extreme cold or heat and wear protective clothing.
- ✓ Always follow good hygiene practices.
- ✓ Each individual is responsible for his or her own safety.

Do You Need Information or Assistance on Thermo Scientific Products?

If you do, please contact us 8:00 a.m. to 6:00 p.m. (Eastern Time) at:

1-740-373-4763

1-800-438-4851

1-877-213-8051

<http://www.thermofisher.com>

service.led.marietta@thermofisher.com

www.unitylabservices.com

Direct

Toll Free, U.S. and Canada

FAX

Internet Worldwide Web Home Page

Tech Support Email Address

Certified Service Web Page

Our **Sales Support** staff can provide information on pricing and give you quotations. We can take your order and provide delivery information on major equipment items or make arrangements to have your local sales representative contact you. Our products are listed on the Internet and we can be contacted through our Internet home page.

Our **Service Support** staff can supply technical information about proper setup, operation or troubleshooting of your equipment. We can fill your needs for spare or replacement parts or provide you with on-site service. We can also provide you with a quotation on our Extended Warranty for your Thermo Scientific products.

Whatever Thermo Scientific products you need or use, we will be happy to discuss your applications. If you are experiencing technical problems, working together, we will help you locate the problem and, chances are, correct it yourself...over the telephone without a service call.

When more extensive service is necessary, we will assist you with direct factory trained technicians or a qualified service organization for on-the-spot repair. If your service need is covered by the warranty, we will arrange for the unit to be repaired at our expense and to your satisfaction.

Regardless of your needs, our professional telephone technicians are available to assist you Monday through Friday from 8:00 a.m. to 6:00 p.m. Eastern Time. Please contact us by telephone or fax. If you wish to write, our mailing address is:

Thermo Fisher Scientific (Asheville) LLC
401 Millcreek Road, Box 649
Marietta, OH 45750

International customers, please contact your local Thermo Scientific distributor.

Table of Contents

Section 1	Installation	1-1
	Positioning	1-2
	Location	1-2
	Floor Installation of Single or Base Unit	1-3
	Floor Installation of Stacked Units	1-3
	Single Unit on a Stand	1-5
	Positioning	1-5
	Single or Base Unit on Stand	1-6
	Stacking Units on a Stand	1-7
	Leveling the Stackable Shaker	1-9
	Chamber Drain	1-10
	Condensate Drain	1-10
	Assemble Flask Clips	1-10
	Install Flask Clips	1-11
	Install Test Tube Holders	1-12
	Test Tube Racks & Adj. Angle Rack Holder	1-13
	RS-232 Interface Connector	1-13
	Connect the Remote Alarm	1-15
	Connect to Electrical Power	1-16
	Quick Release Platform	1-17

Section 2	Operation	2-1
	Introduction	2-1
	Control Panel Operation	2-2
	Quick Start-Up	2-3
	Change Temperature, Speed, Time Settings	2-4
	Factory Settings	2-4
	Hold Temperature Control	2-5
	Change Temperature	2-5
	Change Time	2-6
	Change Speed	2-6
	Alarms	2-7
	Overtemp Shutdown	2-8
	Undertemp Shutdown (SHKE8000-7 & SHKE8000-8CE)	2-8
	Power Failure	2-9
	Cycle Complete	2-9
	RPM Tracking	2-9
	Temperature Sensor Fault	2-10
	Check Belt	2-10
	Temperature is High or Low	2-10
	Check Fuse	2-11
	Platform Stalled	2-11
	Change Configuration	2-11
	Turn the Audible Alarm On and Off	2-12
	Set Alarm Limits	2-13
	Power Failure	2-16
	Cycle Complete	2-16
	Remote Alarm System	2-16
	RPM Tracking	2-17
	Check Belt	2-17
	Temperature High or Low	2-17
	Temperature Sensor Fault	2-17
	Heat %	2-18
	View Total Operating Hours	2-18
	Software Version	2-19
	Heat %	2-19
	Software Version	2-20
	Overtemp Sensor	2-21
	Overtemp Sensor Reading	2-21
	Temperature Control	2-21
	Defrost Control	2-22
	Set the Defrost Temperature	2-23

Section 3	Maintenance	3-1
	Platform and Cabinet Cleaning	3-1
	Quick Release Platform	3-1
	Platform Handle Adjustment	3-2
	Control Panel	3-2
	Clean/Replace Condenser Air Filter	3-2
Section 4	Service	4-1
	Alarms and Alarm Conditions	4-1
	Change the Chamber Air Filter	4-2
	If the Shaker Will Not Operate	4-2
	Replace the Door Stop	4-3
	Spare Fuses	4-4
	Circuit Boards	4-5
	Temperature Sensors	4-5
	Heater Element Circuit Breaker	4-5
	Platform Vibration Adjustment	4-6
	Tune the Cabinet	4-6
	Platform Adjustments	4-6
	Handle Adjustment	4-7
	Calibrate the Temperature	4-8
	Calibrate Platform Speed (RPM)	4-9
Section 5	Specifications	5-1
Section 6	Parts List	6-1
Section 7	Refrigeration Schematic	7-1
Section 8	Electrical Schematics	8-1
Section 9	Warranty Information	9-1

Section 1 Installation

The shipping carton should be inspected upon delivery. When received, carefully examine for any shipping damage before unpacking. If damage is discovered, the delivering carrier should specify and sign for the damage on your copy of the delivery receipt.

Open the carton carefully making certain that all parts are accounted for before packaging materials are discarded. After unpacking, if damage to any of the contents is found, promptly report it to the carrier and request a formal damage inspection.

Important Failure to request an inspection of damage within a few days after receipt of shipment absolves the carrier from any liability for damage. Call for a damage inspection promptly.

MaxQ SHKE8000 Series Stackable Orbital Shakers are shipped with the following materials:

- 4 - Foot pads
- 4 - Painted 1½” spacer blocks
- 4 - 5/16-18 x 4” hex bolts
- 4 - 5/16” lockwashers
- 1 - T-handle 5/32” hex wrench
- 1 - Removeable shaker platform
- 6 - Grade 8, 5/32” hex socket flat head screws (with platform)
- 2 - 7/16” Open end wrench
- 2 - ¾” open end wrench
- 1 - 8¾” Phillips screwdriver for flask clip installation and removal
- 1 - Line cord (country of destination)

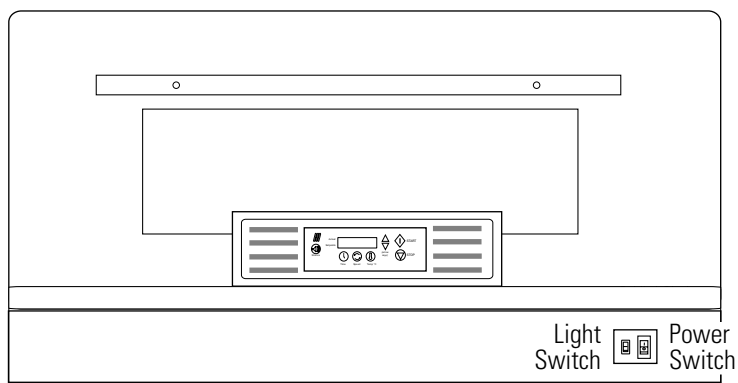

Figure 1-1. Model SHKE8000 Incubated Stackable Orbital Shaker

Location

Locate the shaker on a firm, level surface in an area free of dust and dirt. To allow for service access, the back of the shaker must be at least 4 inches from the wall. Note location of the power and light switches (Figure 1-1).

As the electrical plug is the mains disconnect for the unit, the electrical wall outlet must be easily accessible at all times.

Positioning

Warning Use extreme caution when lifting and positioning these units. Model SHKE8000 & SHKE8000-1CE each weigh 550 lbs (249.5kg) and Model SHKE8000-7 & SHKE8000-8CE each weigh 600 lbs (272.2kg). ▲

Warning Do not lift the unit by hand. Always use suitable equipment designed to support over 600 lbs. (272.2kg). ▲

Warning It is imperative that all specified installation hardware be used when stacking shakers. Failure to do so may result in severe injury and/or equipment damage. ▲

Caution Do not lift Model SHKE8000-7 or SHKE8000-8CE under the refrigeration assembly attached to the side of the shaker! This structure is not designed to support the weight of the unit. ▲

Caution Do not lift or position the unit by the door or door handle. Damage to door mounting and gasket may occur. ▲

Caution Do not lift with forklift or other lifting device near the center of the unit base. Damage to the shaker mechanism mounting may occur. When lifting from the base, position the lifting device as close as possible to the leveling feet. Whenever possible, lift the unit by the four threaded inserts (Figure 1-2). Do not attempt to lift a stack of units by the threaded inserts. The inserts are provided to lift and position only one unit at a time. ▲

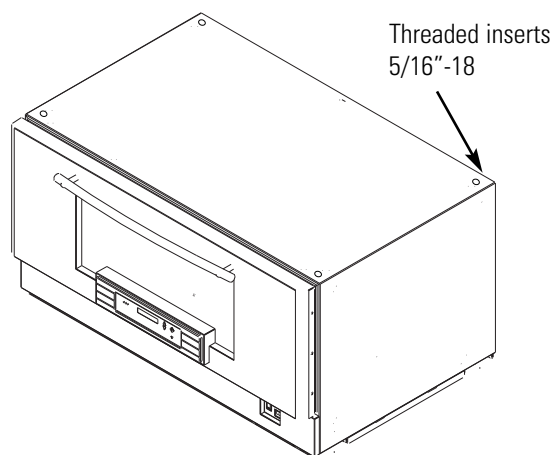

Figure 1-2. Exterior Top of Unit

Floor Installation of Single or Base Unit

Make sure unit is turned off and disconnected from the power source.

1. To install a single unit, or the base unit of a stack on the floor, first position the unit in its final location.
2. Install the neoprene pads under each of the units leveling feet (Figure 1-3).
3. Level the unit. Refer to Leveling the Stackable Shaker in this section.

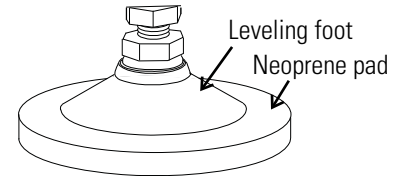

Figure 1-3. Leveling Feet

Floor Installation of Stacked Units

Before stacking the units, make sure all are turned off and disconnected from the power source. Move the units to the final position. The stacking of multiple units (minimum 3 units total) can be accomplished from the front of the unit. To access the stacking connection points to secure one unit to another, remove the front kick panel (Figure 1-4).

If access to rear of unit is possible with cabinet in final position, the back cover plate can be removed for easier access to connection points. See Figure 1-5. Reinstall the back cover plate after stack is secure.

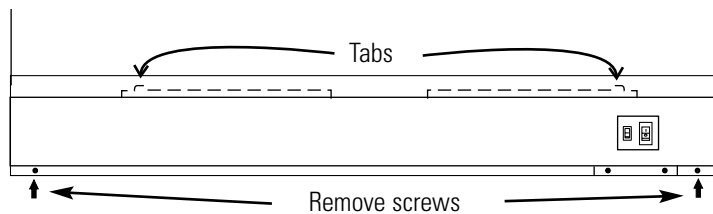

Figure 1-4. Kick Panel on Front of Unit (middle or top unit)

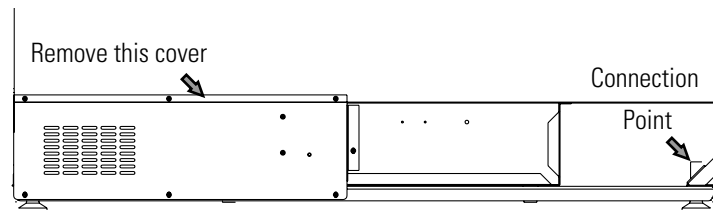

Figure 1-5. Cover Plate on Back of Unit (middle or top unit)

Floor Installation of Stacked Units (cont.)

1. For easier access to stacking connection points on the middle or top units, the four screws on the front of the relay box bracket may be removed (Figure 1-6). The relay box can be pushed carefully back approximately an inch or pulled carefully outward to access the back connection point. The stacking hardware can then be installed as follows. When the stack has been secured, pull the relay box forward and reinstall the four screws.

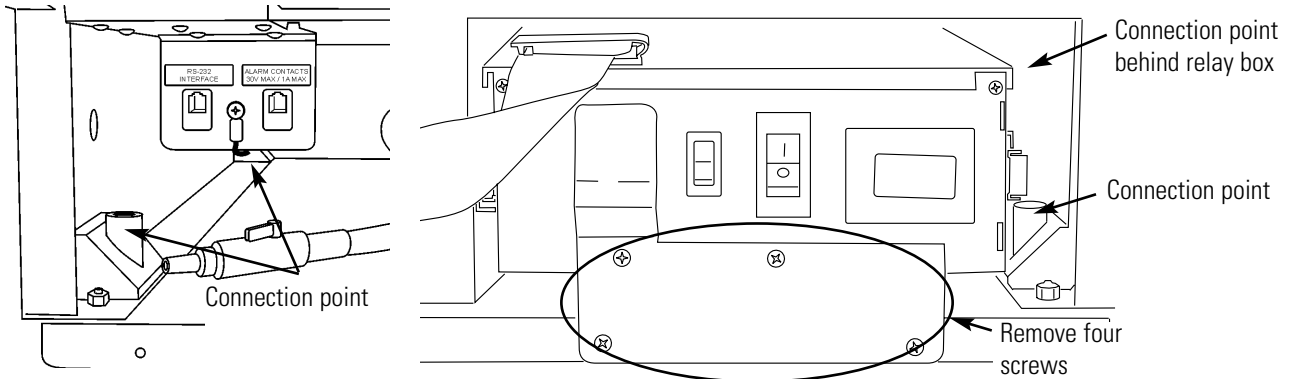

Figure 1-6. Remove Four Screws (middle or top unit)

2. Place the 1½ inch tall spacers (Figure 1-7) over the threaded inserts in the top four corners of the base unit (Figure 1-2).
3. Using the appropriate lifting device, carefully raise the unit to be stacked. Remove all (4) leveling feet.

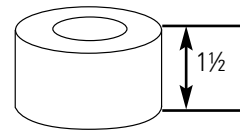

Figure 1-7. Spacer

4. Carefully lift and position the middle or top unit over the spacers on the base unit. Align the (4) connection point holes in the bottom of the middle or top unit with the (4) spacers and threaded inserts. (Helpful hint: use masking tape around outside edge of spacers to hold in place during installation. Remove tape after installation.)

5. Assemble the lockwashers, then the flatwashers, onto the 5/16-18 x 4” bolts. Thread the bolts through the connection point and spacer and into the unit below (Figure 1-8). Tighten bolts.

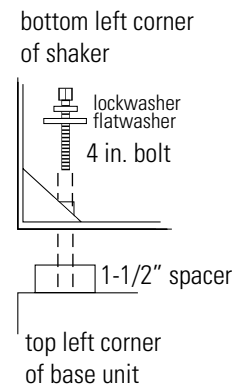

Figure 1-8. Shaker To Shaker

6. Repeat Steps 2 through 5 for top unit if required.
7. Reinstall all brackets and cover panel. Be careful when routing wiring and wire connectors on rear of relay box. This may affect operation of the shaker.

Single Unit on a Stand

Stackable Shaker Stands (Stock #194222 and 194223) are shipped with the following materials:

- 4 - Foot pads
- 4 - Painted spacers blocks 1" high
- 4 - ½"-13 x 4" hex head bolts
- 4 - 5/16" lockwashers
- 4 - D-shaped washers

Locate the shaker stand on a firm, level surface in an area free of dust and dirt. To allow for service access, the shaker back must be at least 4 inches from the wall. Note location of power and light switches (Figure 1-9).

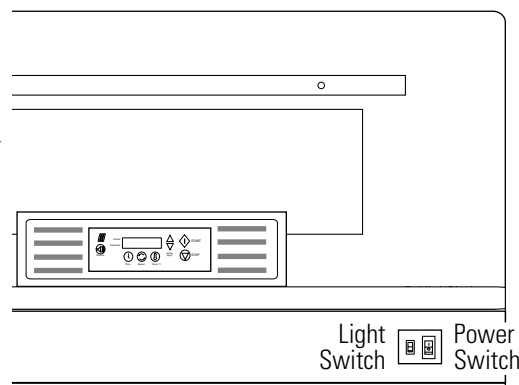

Figure 1-9. Model SHKE8000 Series Incubated Stackable Orbital Shaker

As the electrical plug is the mains disconnect for the unit, electrical wall outlet must be easily accessible at all times.

Positioning

Warning Use extreme caution when lifting and positioning these units. Model SHKE8000 & SHKE8000-1CE each weigh 550 lbs (249.5kg) and Model SHKE8000-7 & SHKE8000-8CE each weigh 600 lbs (272.2kg). ▲

Warning Do not lift the unit by hand. Always use suitable equipment designed to support over 600 lbs. (272.2kg). ▲

Warning It is imperative that all specified installation hardware be used when stacking shakers. Failure to do so may result in severe injury and/or equipment damage. ▲

Caution Do not lift Model SHKE8000-7 or SHKE8000-8CE under the refrigeration assembly attached to the side of the shaker! This structure is not designed to support the weight of the unit. ▲

Caution Do not lift or position the unit by the door or door handle. Damage to door mounting and gasket may occur. ▲

Positioning (continued)

Caution Do not lift with forklift or other lifting device near the center of the unit base. Damage to the shaker mechanism mounting may occur. When lifting from the base, position the lifting device as close as possible to the leveling feet. Whenever possible, lift the unit by the four threaded inserts (Figure 1-10). Do not attempt to lift two units by the threaded inserts. The inserts are provided to lift and position only one unit at a time. ▲

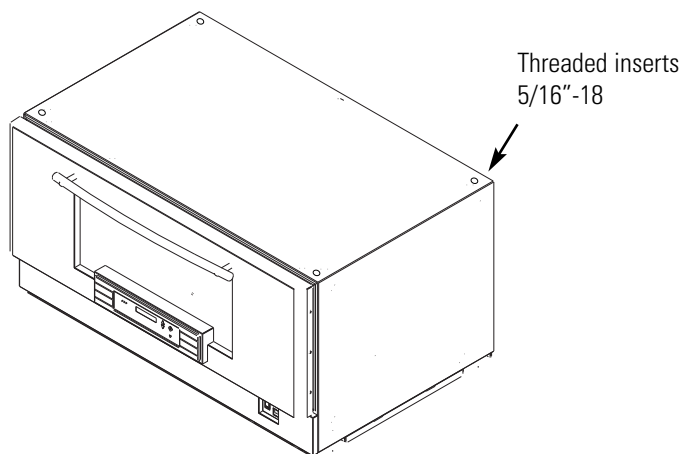

Figure 1-10. Exterior Top of Unit

Single or Base Unit on Stand

Make sure unit is turned off and disconnected from the power source.

1. To install a single unit, or the base unit of a stack, first position the stand in its final location.
2. Assemble the neoprene pads to the bottom of each of the leveling feet (Figure 1-11).
3. Place a 1 inch tall spacer over each hole on the top four corners of the stand. Refer to Figure 1-12.

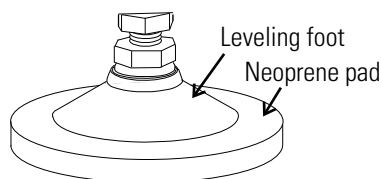

Figure 1-11. Leveling Feet

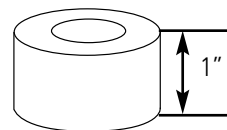

Figure 1-12. Spacer

4. Using the appropriate lifting device, carefully raise the unit to be stacked and remove all (4) leveling feet.

Single or Base Unit on Stand (continued)

- Carefully lift and position the unit over the spacers on the stand. Align the (4) connection point holes in the bottom of the unit with the (4) spacers and holes in the stand. (Helpful hint: Use masking tape around outside edge of spacers to hold in place during installation. Remove tape after installation.)
- Assemble the lockwashers, then the D-shaped flatwashers onto the ½”-13 x 4” bolts. Then thread the bolts through the underside of the stand top rails, through the spacers and into the holes in the bottom of the unit. Tighten these bolts to secure the shaker to the stand. Refer to Figure 1-13 and 1-14.

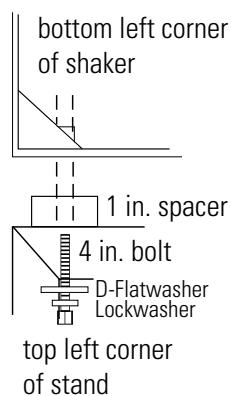

Figure 1-13. Shaker To Stand

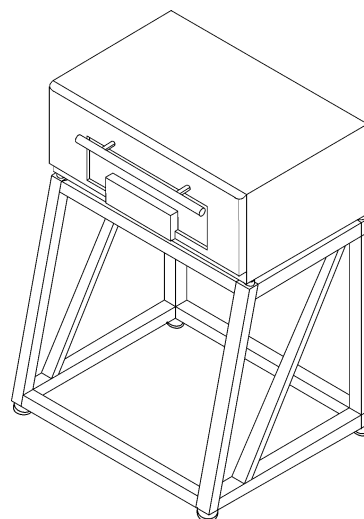

Figure 1-14. Single Shaker on Stand

- Level the stand. Refer to the Leveling the Stackable Shaker section of this manual.

Stacking Units on a Stand

The stacking of two units can be accomplished from the front of the unit. To access the stacking connection points needed to secure one unit to another, remove the front kick panel of the top unit (Figure 1- 15). If access to the rear of the unit is possible in it's final position, the back cover plate can be removed for easier access to connection points. See Figure 1- 16. Re-install back cover plate after stack is secure.

Stacking Units on a Stand (continued)

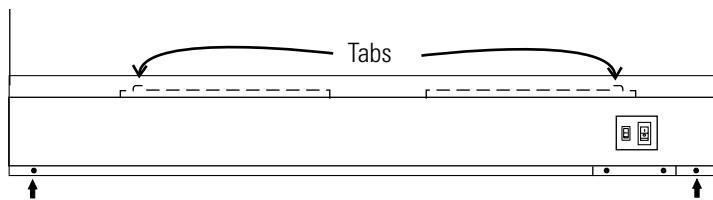

Figure 1-15. Kick Panel on Front of Unit (middle or top unit)

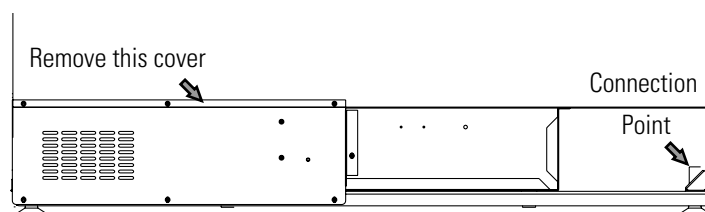

Figure 1-16. Cover Plate on Back of Unit

1. For easier access to stacking connection points on the top unit, the four screws on the front of the relay box bracket may be removed (Figure 1-17). The relay box can be pushed carefully back approximately an inch or pulled carefully outward to access the back connection point. The stacking hardware may then be installed as follows. When the stack has been secured, pull the relay box forward and reinstall the four screws.

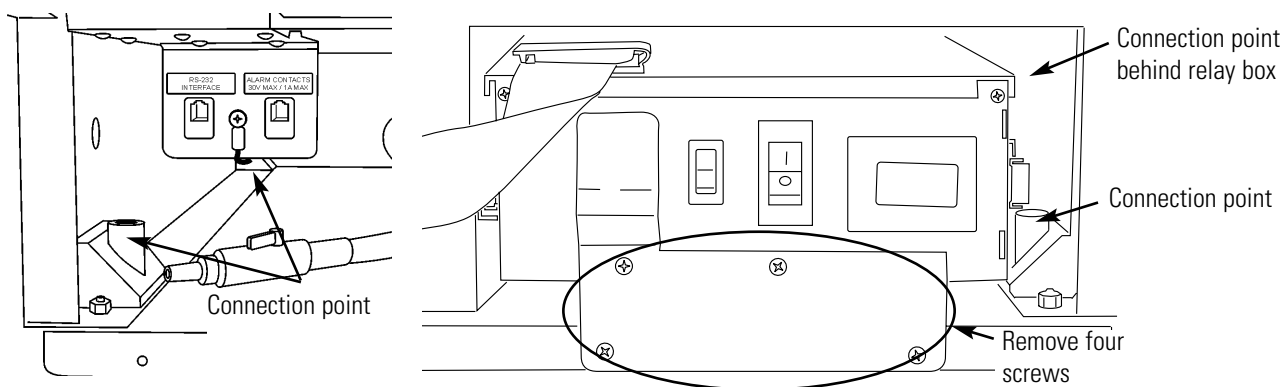

Figure 1-17. Remove Four Screws (top unit)

2. Place the 1-1/2 inch tall spacers (Figure 1-18) over the threaded inserts in the top four corners of the bottom unit (Figure 1-10).
3. Using the appropriate lifting device, carefully raise the unit to be stacked and remove all (4) the leveling feet.

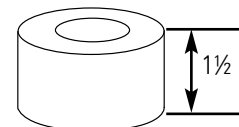

Figure 1-18. Spacer

Stacking Units on a Stand (continued)

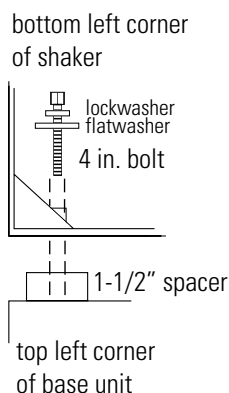

Figure 1-19. Shaker To Shaker

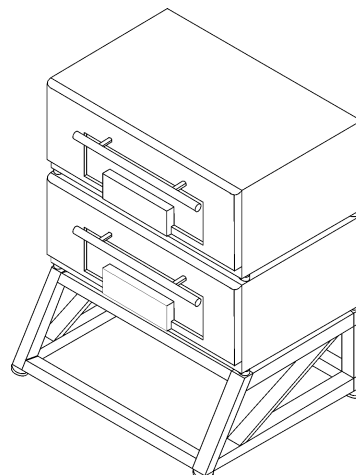

Figure 1-20. Two Shakers Stacked on Stand

4. Carefully lift and position the top unit over the spacers on the bottom unit. Align the (4) connection point holes in the bottom of the top unit with the (4) spacers and threaded inserts. (Helpful hint: Use masking tape around outside edge of spacers to hold in place during installation. Remove tape after installation.)
5. Assemble the lockwashers, then the flatwashers onto the 5/16-18 x 4" bolts. Then thread the bolts through the connection point and spacer, and into the unit below. Refer to Figures 1-19 & 1-20. Tighten bolts.
6. Reinstall all brackets and cover panel. Be careful when routing wiring and wire connectors on rear of relay box. This can affect operation of the shaker.

Leveling the Stackable Shaker

After positioning the shaker (or stack) in its final location, it is critical that the unit(s) be as level as possible. Each of the leveling feet on a shaker or stand has an adjustment nut (the lower one, for leveling purposes) and a locknut (the upper one, for securing the adjustment). See Figure 1-21.

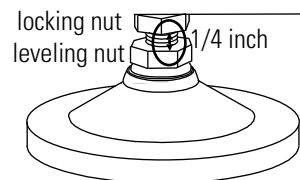

Figure 1-21. Leveling Feet

Using a 3/4" or adjustable wrench, turn the adjustment nut (to extend the leveling foot) to achieve a level condition. Make sure the shaker (or stack) is leveled side-to-side and front-to-back. This can usually be accomplished by adjusting only two feet. Verify that all four feet are in full contact with the floor when leveling is complete. To "tune out" any vibrations, see the Tuning the Cabinet section. After each leveling and/or tuning, secure the adjustment in place by tightening the locknut against the base of the cabinet/stand.

Caution Leveling feet extend only a very short distance. When unit is leveled and tuned, with leveling feet locked in place, adjustment and locking nuts should be no further than 1/4 inch apart. ▲

Chamber Drain

A drain is provided in the bottom of the chamber for convenience when cleaning or removing spills (Figure 1-22). A clear vinyl hose and plastic valve are connected to the drain and accessed by removing the lower front panel. The panel has two screws along the bottom and tabs along the top located in slots.

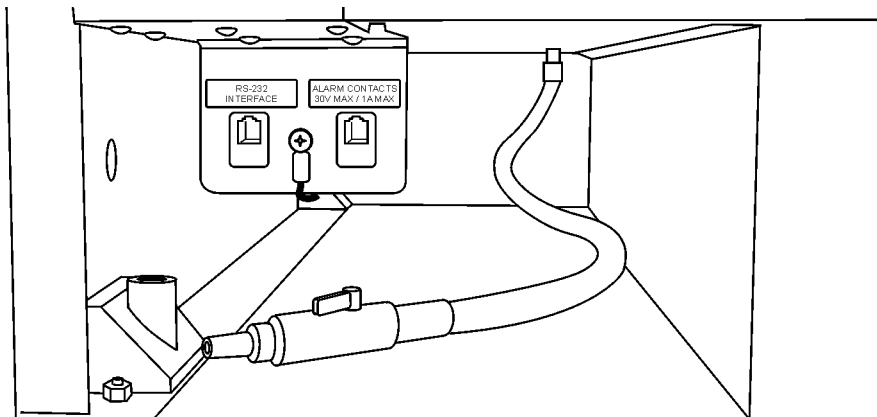

Figure 1-22. Chamber Drain

Condensate Drain

A 3/8" O.D. stainless steel condensate drain is located on the right side of the shaker in the side car (refrigerated models only). This drain removes any water which may collect in the air ductwork. Water accumulates into a pan where it is evaporated by the heat from the refrigeration system. This drain does not require maintenance.

Assemble Flask Clips

Each flask clip up to 2.8 liters in size comes with a metal spring which must be installed onto the clip. For flask clips through 500 ml, insert the end of each spring into the holes on the top of the clip leg as shown in Figure 1-23.

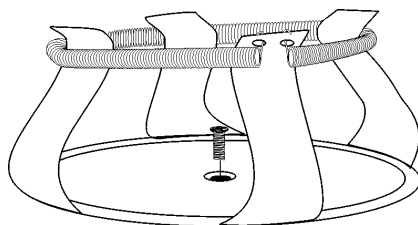

Figure 1-23. Clip Assembly

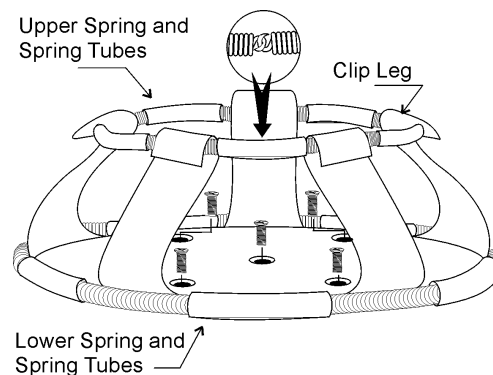

Figure 1-24. For Liter or Larger Flasks

Assemble Flask Clips (continued)

The 2.0 and 2.8 liter Flask Clips use two sets of metal springs and rubber spring tubes. On these larger clips, the springs are installed by hooking their ends together as illustrated in Figure 1-24. The upper spring and spring tubes should be installed prior to mounting the clip to the platform. The lower spring and spring tubes however, are placed around the bottom of the clip legs after the flask clip is fastened to the platform.

Note that rubber spring tubes are placed between each clip leg.

Install Flask Clips

All models accommodate glassware in numbers and sizes from ninety-one 25ml flasks to six 2.8 liter flasks. All platforms have mounting holes for flask clips and test tube racks made by other manufacturers.

Listed below are the dedicated platform kits available for these shakers.

Table 1-1. Available Dedicated Platform Kits

Dedicated Platform Number	No. of Clips	Flask Size	Springs per Clip	Screws per Clip
238066	91	25 ml	1	1
238067	91	50 ml	1	1
238068	40	125 ml	1	1
238069	30	250/300 ml	1 (w/ 1 large pad)	1
238070	40	250/300ml	1 (w/ 1 large pad)	1
238071	24	500 ml	1	1
238072	15	1 L	1	5
238073	12	2 L	2 (w/ 10 tubes)	5
238074	6	2800mL	2 (w/ 10 tubes)	5

Flask clips can be attached anywhere on the shaker platform and flasks can be inserted into any flask clip as the counter-balanced design of these shakers compensates for unbalanced loads.

The flask clips are supplied with the proper screws and can be attached to the platform with a standard Phillips screwdriver or the screwdriver provided with the unit.

Figures 1-25 and 1-26 illustrate the installation of the flask clips. Note that clips for 1, 2 and 2.8 liter flasks use five screws. The 250/300ml flask clip has an adhesive-backed flask cushion pad which is installed on the flat base of the clip body. A hole is provided in the pad for the mounting screw.

Install Test Tube Holders

The Accessory Test Tube Racks and Test Tube Rack Holders are available in four sizes and are listed in Table 1-2.

Table 1-2. Available Test Tube Racks and Holders

Part Number	Description
950040	Test Tube Rack, 10-13 mm size
950060	Test Tube Rack, 16-20 mm size
600074	Test Tube Rack, 21-25 mm size
600075	Test Tube Rack, 26-30 mm size
600076	Adjustable-Angle Test Tube Holder with Rack, 10-13 mm
600077	Adjustable-Angle Test Tube Holder with Rack, 16-20 mm
600078	Adjustable-Angle Test Tube Holder with Rack, 21-25 mm
600079	Adjustable-Angle Test Tube Holder with Rack, 26-30 mm
600088	Universal Adjustable-Angle Test Tube Holder, 10-25 mm
600089	2 Tier Micro-Plate Rack
600090	3 Tier Micro-Plate Rack
194024	#10-24 pan head Phillips screws for mounting test tube holders to Orbital Shaker platforms

All the Test Tube Rack Holders are adjustable in seven positions, swinging and locking at 15°, 30° and 45° in either direction. Figure 1-25 illustrates the Test Tube Rack Holder with the rack in place.

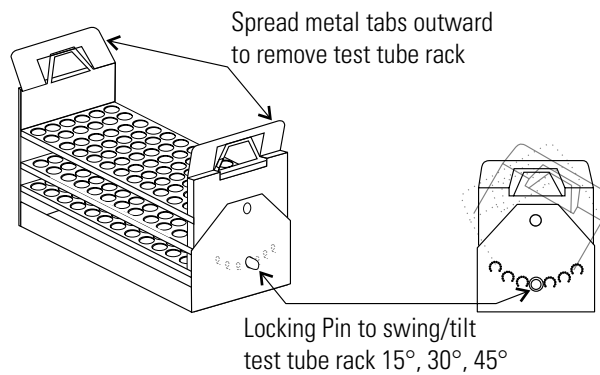

Figure 1-25. Test Tube Rack with Swing/Tilt Mechanism

Test Tube Racks & Adj. Angle Rack Holder

To remove the rack, spread the metal tabs on either end of the holder and lift it out.

To install the Test Tube Rack Holder onto the shaker platform, remove the rack and rotate the swing-bed of the holder 90° by pulling the knobs of the locking pins on either end of the holder outward. The pins are locked in the outward position by turning the knobs 1/4-turn (Figure 1-26).

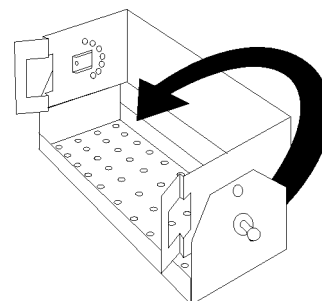

Figure 1-26. Test Tube Rack Holder w/
Rack Removed and Bed Rotated 90°

Attach the holder to the platform with the screws provided.

RS-232 Interface Connector

These orbital shakers are equipped with an RS-232 Serial Communication Interface for the remote transmission of data. An RJ-11 telephone style connector is located on the lower front left corner of the cabinet, behind the kick panel (Figure 1-27). A cable with RJ-11 plugs and an RJ-11 to DB-25 adapter are required.

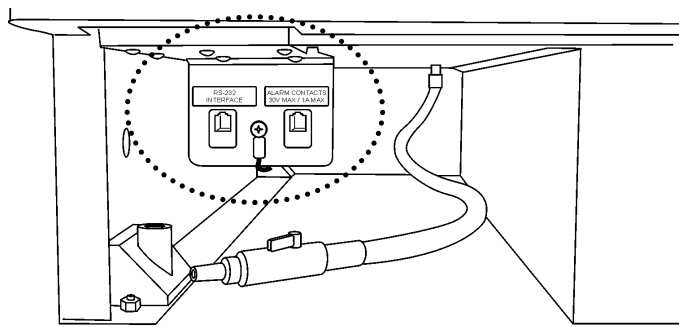

Figure 1-27. Location of RS-232 and Remote Alarm Connectors

RS-232 Interface Connector (cont.)

Figure 1-28 identifies the RS-232 and Remote Alarm connector pins.

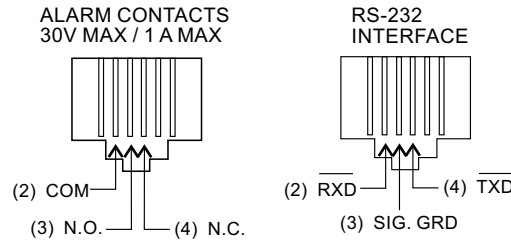

Figure 1-28. Remote Alarm and RS-232 Connectors

The data is “dumb terminal” formatted, which permits interfacing with either a computer or a serial printer.

Three wires are used for the RS-232 interface:

1. Transmit data (/TXD) - pin 2 DB-25 connections
2. Receive data (/RXD) - pin 3 DB-25 connections
3. Signal ground (GND) - pin 7 DB-25 connections

The data format is:

Baud1200 (9600 baud with jumper at J2 on the Control Board)
 Data bits 8 (7 bit ASCII with leading zero)
 Start bits 1
 Stop bits 1
 Parity none

The data transfer sequence is transmitted in the following format. X refers to the numerical time, speed and temperature.

(NUL)XXX.XX(H)(SP)(SP)XXXRPM(SP)(SP)XX.XC(SP)(LF)(CR)(EOT)
 NULNull character (0)
 SPSpace (32)
 LFLine feed (10)
 CRCarriage return (13)
 EOTEnd of transmission (4)
 HH for timer count up mode (Hold) or no
 H for timer countdown mode

RS-232 Interface Connector (cont.)

The MaxQ SHKE8000 Series Shakers transmit time, speed and temperature information one minute after power is first applied to the unit and then every 60 minutes thereafter unless the shaker receives either a <Ctrl><Q> or a <Ctrl><S>.

The shaker's microprocessor responds to two commands from the remote.

- <Ctrl><Q> (XON)

The shaker will immediately transmit time, speed and temperature data upon receiving <Ctrl><Q> and will reset the 60 minute data transmission interval timer.

- <Ctrl><S> (XOFF)

The shaker will stop serial data transmission upon receiving a <Ctrl><S> until a <Ctrl><Q> is received or power is cycled.

Connect the Remote Alarm

IMPORTANT USER INFORMATION

CAUTION! Stored product should be protected by a redundant 24 hour/day monitoring system with alarm capability. An interconnect jack and thermocouple are installed for centralized monitoring, should on-board system fail.

An internal, remote alarm SPDT relay is provided to monitor alarms and is connected by an RJ-11 (telephone style) jack, located on the lower left front corner of the cabinet, behind the kick panel. The relay provides NO (normally open) and NC (normally closed) output and may be wired to a central remote alarm location or to an independent alarm system.

Figure 1-28 identifies the pin contacts. Figure 1-27 shows the location of the Remote Alarm Connector.

A modular to modular cable (Stock No. 190388) and an RJ-11 telephone style terminal converter (Stock No. 190392 or equivalent) may be used to convert to a screw terminal connection. Refer to Figures 1-29 and 1-30.

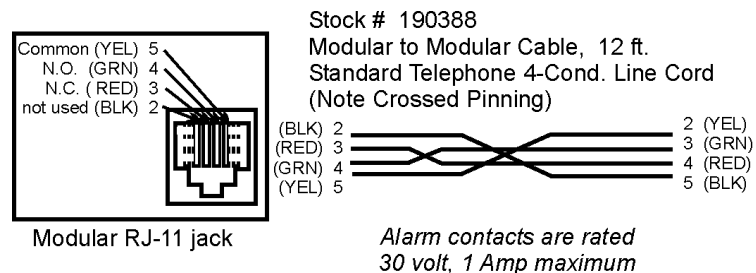

Figure 1-29. Pin Connections

Connect the Remote Alarm (continued)

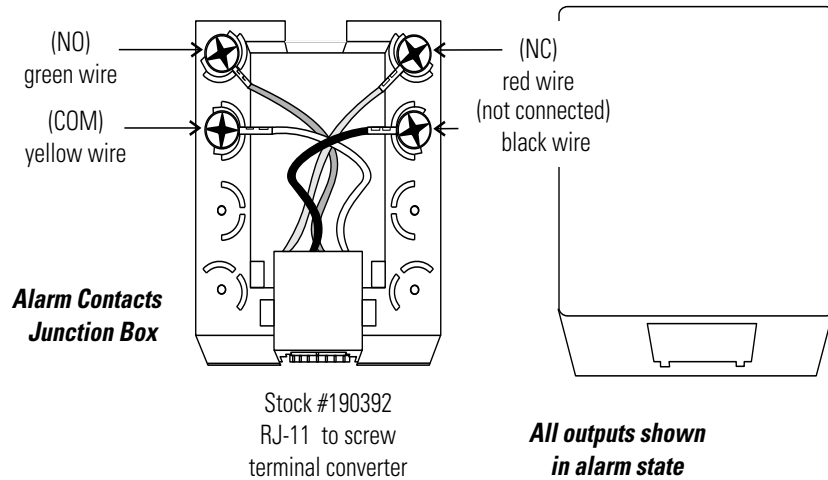

Figure 1-30. Converter

Connect to Electrical Power

Connect the line cord to the power inlet on the back of the unit. Route the cord through the factory-installed tie wrap anchor and tie wrap into place. This avoids accidental disconnection of the power cord from the unit.

See the serial tag on the side of the unit or Specification section for electrical specifications. Refer to the electrical schematics at the end of this manual.

Caution Connect the orbital shaker to a grounded, dedicated circuit. The power outlet plug is the mains disconnect device for the orbital shaker. Position the unit so the plug is easily accessible. ▲

Quick Release Platform

The quick release platform base is shipped already installed in the unit.

1. To load the platform, open the chamber door.
2. Grasp the center handle, pull the inner release bar upward, then press the handle downward until it clicks into a horizontal position.
3. Pull outward on the platform. Load your samples, making sure all are securely fastened. Push the platform all the way into the chamber.
4. Pull up on the inner release bar and press the center handle upward into a vertical position. The door to the chamber may now be closed.

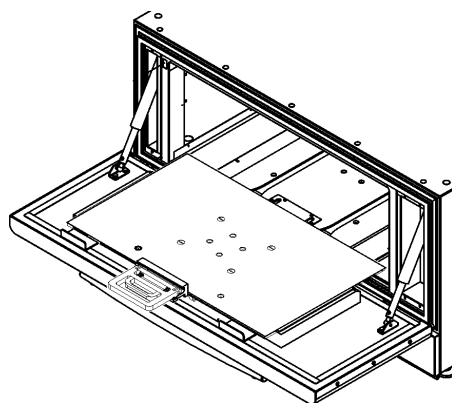

Figure 1-31. Handle When Loading

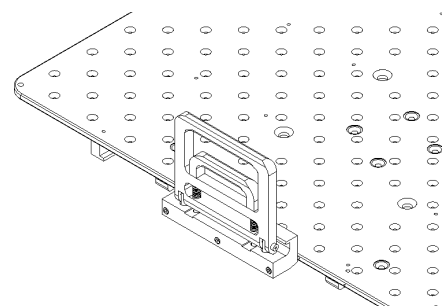

Figure 1-32. Handle Up to Close Door

Note The platform must be fully inserted into the cabinet and the center handle pressed into the 'up' position to ensure the platform is secured. ▲

Section 2 Operation

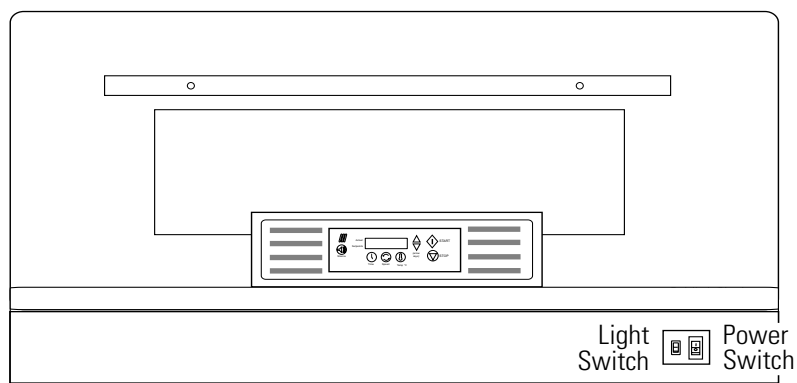

Figure 2-1. Model SHKE8000-7 Incubated/Refrigerated Stackable Shaker

Introduction

The incubated and incubated/refrigerated orbital stackable shaker models are microprocessor-controlled and designed to accommodate a wide variety of flasks, test tubes and other glassware. The control system is easily programmed and stores the user-defined time, temperature and speed settings in battery-supported memory which remains even when the shaker is turned off and unplugged.

The platform speed controller continuously adjusts for line voltage fluctuations and provides smooth transitions with consistent control. The circuitry is designed to slowly bring the platform up to speed and down to a stop to prevent splashing from flasks or test tubes.

Important Refrigerated models only - Line Frequency Switch must be set to the correct mains line frequency before power is applied. Figure 1-4 shows switch location. ▲

The insulated door with viewing port has pneumatic dampers and spring assist for ease in opening and closing. A safety interlock requires that the door be closed for the drive motor, circulating fans and temperature control system to operate.

Caution It may take up to one minute to bring the platform up to full speed. Never leave the shaker unattended while starting. Make sure all flasks and test tube racks are firmly seated in the clips. Check the security of the flask clip and platform attachment screws monthly. Do not operate the shaker at maximum speed without a load. ▲

Warning Do not load or unload the platform until it has come to a complete stop. ▲

Control Panel Operation

The control panel on these units has a liquid crystal display and eight operating buttons that are identified by word and symbol. During programming, the up and down arrows increase and decrease the numerical values of time, platform speed, or temperature. Press and hold either arrow to cause values to scroll in that direction; hold for more than five seconds to increase scrolling speed.

When changing the system configuration, the down arrow advances the display to the next screen, while the up arrow returns the display to the previous screen. Pressing the Time, Speed and Temperature button selects the parameter above it to be changed, while the up and down arrows increase and decrease the numerical values, respectively, or toggle between two different options. Pressing and holding either arrow will cause the values to scroll in that direction. Pressing and holding for more than 5 seconds increases the scrolling speed.

The START button begins platform operation as defined by the Time and Speed setpoints, while the STOP button halts the platform. Chamber temperature begins upon power-up as defined by the Temp setpoint.

The alarm indicator and alarm silence button complete the shaker control panel. When in alarm, the unit sounds an audible warning and flashes the three red indicators. Depending on the error detected, pressing the Silence button turns off the audible alarm. However, the three red indicators continue to flash until the alarm condition is corrected. For most alarms, the audible warning will sound again in about fifteen minutes, if the condition is not corrected.

Alarm features are discussed in detail later in this section.

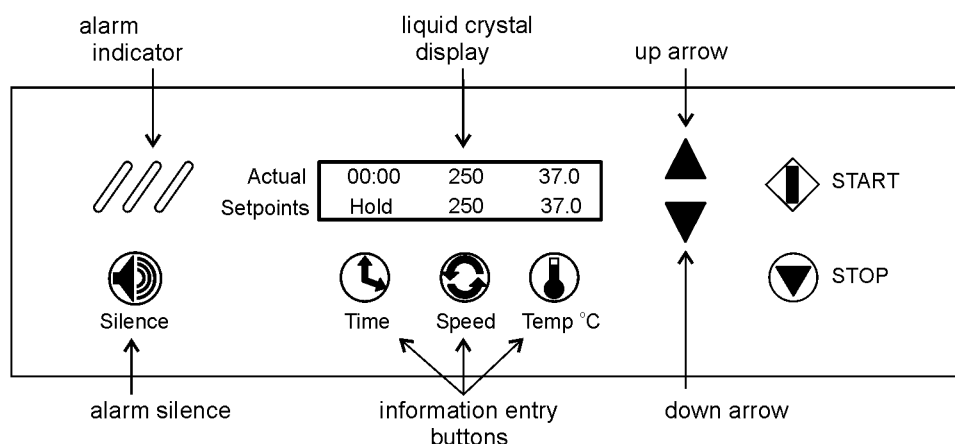

Figure 2-2. Control Panel

Quick Start-Up

Caution If the unit is shipped or stored in very cold conditions, allow the unit to warm to ambient temperatures before using. ▲

Caution This unit should be operated by trained personnel only, as described in this manual. All appropriate personal protective equipment should be worn as required. ▲

At power-up, one of the the screens at right will appear on the display for 10 seconds (where X.XX is the current software revision) before it shows the Actual and Setpoint times, speeds and temperatures similar to those illustrated in Figure 2-2. For convenience, this is called the Operating Screen throughout this manual.

Software Version # 443 / 444 / 445 REL X.XX
--

SHKE8000 & SHKE8000-1CE

Software Version # 493 / 495 / 496 REL X.XX
--

SHKE8000-7 & SHKE8000-8CE

Initially, the Actual values along the top of the liquid crystal display will differ from the Setpoint values shown along the bottom. The Actual numbers will change as the unit continues to operate.

Time - With the time set at Hold, the time showing in the upper left portion of the LCD will begin to count upward, showing the total operating hours and minutes. The system will reset to 00:00 whenever the unit is stopped and restarted, using the Stop and START buttons. The system will not reset if the unit is turned off and on using the power switch, or if the shaker door is repeatedly opened and closed.

Speed - The speed shown in the upper center portion of the LCD will indicate the present platform speed. It will display zero RPM at rest and will gradually rise to the setpoint speed after the START button is pressed and the platform begins to rotate.

Temperature - The temperature shown in the upper right portion of the LCD will indicate the ambient temperature inside the shaker and will gradually move toward the setpoint value.

The values shown in Figure 2-2 are factory default settings. Other factory settings are shown in the table below.

Table 2-1. Factory Default Settings

Function	Default SHKE8000 & SHKE8000-1CE	Default SHKE8000-7 & SHKE8000-8CE
Audible Alarm	ON	ON
RPM Tracking Limit (fixed)	5 RPM	5 RPM
Temp Tracking Limit	10°C	10°C
Over Temp Shutdown	63°C - 65°C	
Under Temp Shutdown	N/A	-1°C to +2°C
All Remote Alarms	ON	ON
Defrost	N/A	ON, 12°C

Factory Settings

The Stackable Shakers are shipped from the factory with the following default settings:

Time: When the shaker is turned on for the first time, the liquid crystal display will show 00:00H. (Hold time) This means the unit is set to record accumulated operating time. Any programming changes in the Time settings are made in increments of five minutes.

Speed: The display shows the unit ready to operate at 25 RPM. Programming changes in Speed are made in increments of 1 RPM. However, if the up or down buttons are held for about two seconds, the display will scroll in that direction.

Temperature: The display shows the operating temperature set at 35.0°C. Changes to the Temperature program settings are made in increments of 0.1°C. However, if the up or down buttons are held for about two seconds, the display will scroll in that direction.

The Stackable Shaker can be easily programmed to meet the most demanding laboratory requirements using its microprocessor-based technology. The following sections outline the procedures for changing the settings and programming the control system.

Change Temperature, Speed, Time Settings

All programming or setting changes start from the Operating Screen as typically illustrated in Figure 2-2.

The instructions to program the Stackable Shaker are written in a step-by-step format. For convenience, these instructions begin and end at the Operating Screen.

Note If no control panel buttons are pressed for about fifteen seconds during programming or changing configuration settings, the display automatically returns to the Operating Screen, storing and acting upon any changes made. New settings are also stored and acted upon immediately when either arrow button is pressed.



Change Temperature

1. Press the button beneath temperature setpoint (Temp°C). The Run temperature value will begin to flash.
2. Press the up or down arrows to set the new Run temperature in 0.1°C increments. Hold either arrow button to scroll. However, if the up or down arrow buttons are held for about 2 seconds, the display will scroll in that direction.
3. Press the temperature button again. The Hold temperature value will begin to flash. Press the up and down arrow buttons to set the new Hold temperature in 0.1°C increments. Hold either arrow button to scroll. If the up or down arrow buttons are held for about 2 seconds, the display will scroll in that direction.
4. Press the temperature button one more time (twice for Model SHKE8000-7 & SHEK8000-8CE) to return to the Operating Screen.

The temperature can be set over a range of 5.0°C to 60.0°C. However, Model SHKE8000 & SHKE8000-7 may not control temperature properly if the temperature is set less than 10.0°C above ambient temperature.

Note Heating system and temperature alarms can be disabled on Model SHKE8000 & SHKE8000-1CE by setting the temperature to 4.0°.

Hold Temperature Control

The Model SHKE8000-7 & SHKE8000-8CE Shakers have the ability to hold the product at a specific temperature after operating for a predetermined time.

A typical example is shown at right. In this example, the shaker is operating at 250 RPM with cabinet temperature at 37°C. The 06:30 time value in the lower left corner of the display indicates that the shaker is counting down and will stop motion in six and one-half hours.

Actual	06:30	250	37.0
Setpoints	06:30	250	37.0



The illustration at right shows that time has counted down to zero and the shaker platform has stopped (zero RPM). The temperature value of 5.0°C in the lower right corner of the display is the temperature at which the product is being held. Hold will continue at this temperature until the START button is pressed or a new Hold or operating temperature is entered.

Actual	00:00	00	37.0
Setpoints	06:30	250	37.0



Hold Temperature Control (continued)

To set a new Hold temperature, press the Temp button twice. The screen at right appears. The Hold temperature flashes.

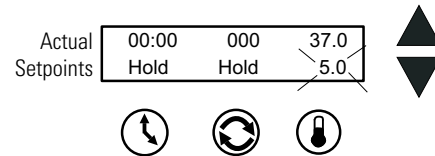

Using the up and down arrows, program a new Hold temperature. Press the Temp button or press nothing for about 15 seconds to save the new setting and return to the Operating Screen.

Change Speed

1. Press the button beneath the speed setpoint. The speed value will begin to flash.
2. Press the up or down arrows to set the new speed in 1 RPM increments. Hold either arrow button to scroll. However, if the up or down arrow buttons are held for about 2 seconds, the display will scroll in that direction.
3. Press the speed button again to return to the Operating Screen.

Speed can be set over a range of 25 to 400 RPM.

Change Time

The Stackable Shaker manages operating time in two ways:

Hold - When time is set to Hold, the value shown in the 'Actual' display represents total operating time and may be reset at the operator's convenience. The shaker will continue to count upwards even if the shaker door has been repeatedly opened and closed, or turned off and on with the power switch. The time however, will reset to 00:00 when the STOP button is pressed, then the unit restarted by pressing the START button.

Countdown - When the Hold setpoint is changed to Countdown, entering a time value in hours and minutes programs the platform to operate for that period of time and automatically stop platform motion. The display will show the programmed time in the Setpoint segment and the operating time remaining in the 'Actual' display, as the microprocessor counts down to zero. The countdown time can be set over a range of 5 minutes to 200 hours in 5 minute increments.

An additional feature on Model SHKE8000-7 & SHKE8000-8CE is Hold temperature. The refrigerated shaker can be programmed to operate at one temperature, then hold the cabinet at another temperature when the countdown reaches zero. The platform will stop, but the fans and the temperature control systems continue to operate.

Change from Hold to Countdown

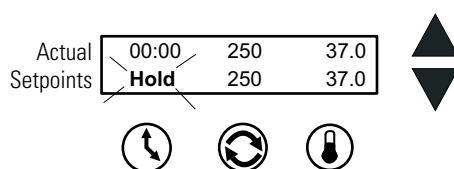

1. Press the button beneath the time setpoint. Hold will begin to flash.
2. Press either arrow to access the countdown time setpoint. The last preset time setpoint will begin to flash.
3. Press the up or down arrows to set the desired operating time in five minute increments. Hold either arrow to scroll in that direction. However, if the up or down arrow buttons are held for about 2 seconds, the display will scroll in that direction.
4. When the desired elapsed time is set (8 hours, 30 minutes in this example), press the Time button to return to the Operating Screen. Pressing the START button will start the platform and begin the countdown sequence. As it counts down, the Actual time shown will decrease. When 00:00 is reached, the shaker platform motion will automatically stop and the Cycle Complete alarm will sound.

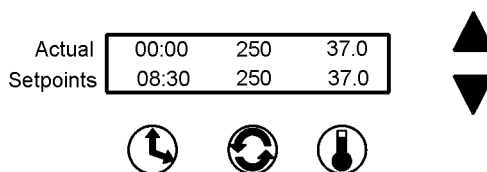

Alarms

The Stackable Orbital Shaker control system monitors and provides alarms for nine operating parameters.

Parameter	Alarm Message	Remote Alarm
Overtemp Setpoint Status	Overtemp Shutdown, Undertemp Shutdown (refrigerated units)	No
Cycle Status	Cycle Complete	Yes
Loss of Input Power	Power Failure	Yes
RPM versus Setpoint	RPM is High, RPM is Low	Yes
Drive Belt Integrity	Check Belt	Yes
Temp Sensor Integrity	Main Temp Sensor, Over Temp Sensor	Yes
Temp Control Status	Temperature is High, Temperature is Low	Yes
Platform Movement Status	Platform Stalled	No
Motor Drive Board Input Power Integrity	Check Fuse	No

Alarms (continued)

Both audible and visual alarm warnings for these nine parameters are provided by the shaker. Visual flashing of the three diagonal indicator lights on the control panel, a progression of alarm messages on the display, and an audible tone alerts the operator that an alarm condition has occurred, or currently exists.

For convenience, the audible tone is muted by pressing the Silence button, but will ring back in about 15 minutes if the alarm condition is still present, for most alarms. However, the alarm indicator lights and alarm messages continue until the alarm condition is corrected by the operator. After the root cause of the fault has been corrected, pressing the Silence button will clear the alarm message from the display. The audible tone will ring back in about 30 minutes for the Check Belt and Check Fuse alarm if the alarm condition is still present. These alarm messages clear from the display when the unit is turned back on after correcting the alarm condition and the alarm indicator lights steady from flashing.

As discussed in the Configuration section of this manual, the audible alarm feature may be turned off to suit operator or laboratory needs. Refer also to the Alarm Message/Corrective Actions chart in the Service section of this manual.

Overtemp Shutdown

Overtemp Shutdown alerts the operator that the overtemp setpoint has been exceeded by a few tenths of a degree. The Overtemp Shutdown message displays and the heaters turn off, but the platform and blowers continue to operate.

Actual	08:41	250	37.0
Setpoints	Overtemp Shutdown		

In the alarm state, the audible alarm is muted by pressing the Silence button, but will ring back in about 15 minutes if the alarm condition is still present. However, the alarm message and indicator lights persist until the fault is corrected. Afterward, the remaining relevant alarm components are cleared by pressing the Silence button.

Undertemp Shutdown (SHKE8000-7 & SHKE8000-8CE)

Undertemp Shutdown alerts the operator that the chamber temperature has dropped below the Undertemp setpoint by a few tenths of a degree. The Undertemp Shutdown message displays and the refrigeration turns off, but the platform and blowers continue to operate.

Actual	08:41	250	37.0
Setpoints	Undertemp Shutdown		

In the alarm state, the audible alarm is muted by pressing the Silence button, but will ring back in about 15 minutes if the alarm condition is still present. However, the alarm message and indicator lights persist until the fault is corrected. Afterward, the remaining relevant alarm components are cleared by pressing the Silence button.

Cycle Complete

Cycle Complete alerts the operator that the end of the count-down running time has been reached. The Cycle Complete message displays and the platform stops. Chamber temperature is controlled by the Hold Temperature setpoint (SHKE8000-7 & SHKE8000-8CE).

Actual	00:00	00	37.0
Setpoints	Cycle Complete		

Pressing the Silence button clears the alarm message from the display screen and mutes the audible alarm.

Power Failure

Power Failure alerts the operator that electrical power to the unit was interrupted, under specific operating conditions. While the system returns to normal operation when power is restored, the alarm message remains and the audible tone continues to sound. Both the display message and the audible tone are cleared by pressing the Silence button.

Actual	00:00	00	37.0
Setpoints	Power Failure		

Note The alarm will not occur if the power failure is less than 15 seconds in duration while the unit is shaking. ▲

If power is interrupted for 1½ hours while the unit is turned on but not shaking, a Power Failure alarm will occur. The purpose of the alarm in this case is to alert the user that an extended duration power failure occurred during the Hold interval after a timed shaking operation (SHKE8000-7 & SHKE8000-8CE), or during a period of incubation only. This alarm will also occur any time the unit is turned on after being turned off for more than 1½ hours (such as when the unit is shipped from the factory, or when it is returned to use after a period of storage).

RPM Tracking

RPM Tracking alerts the operator consistently for at least 2 minutes by the appropriate alarm message (as shown at right), that the platform speed has varied ±5 RPM.

Actual	08:41	255	37.0
Setpoints	RPM is High		

Actual	08:41	245	37.0
Setpoints	RPM is Low		

In the alarm state, the audible alarm is muted by pressing the Silence button, but will ring back in about 15 minutes if the alarm condition is still present. However, the alarm message and indicator lights persist until the fault is corrected. Afterward, the remaining relevant alarm components are cleared by pressing the Silence button.

Check Belt

Check Belt alerts the operator that the drive belt may have broken, is slipping because it needs tightened, or an obstruction is slowing or preventing platform movement.

Actual	08:41	00	37.0
Setpoints	Check Belt		

In the alarm state, the audible alarm is muted by pressing the Silence button, but will ring back in about 30 minutes if the alarm condition is still present. However, the alarm message and indicator lights persist until the fault is corrected. The remaining relevant alarm components are cleared when the unit is turned back on after correcting the alarm condition.

Temperature Sensor Fault

Sensor Fault alerts the operator that either of the shaker's two temperature sensors has failed by the appropriate alarm message as shown at right.

Actual	08:41	250	37.0
Setpoints	Main Temp Sensor		

Actual	08:41	250	37.0
Setpoints	Over Temp Sensor		

In the alarm state, the audible alarm is muted by pressing the Silence button, but will ring back in about 15 minutes if the fault condition is still present. However, the alarm message and indicator lights will persist until the fault is corrected. Afterward, the remaining relevant alarm components are cleared by pressing the Silence button.

Temperature is High or Low

Temperature is High or Temperature is Low alerts the operator that the operating temperature of the shaker has risen above, or fallen below, the programmed temperature tracking limit control point, by the appropriate alarm message as shown.

Actual	08:41	250	47.0
Setpoints	Temperature is High		

Actual	08:41	250	27.0
Setpoints	Temperature is Low		

In the alarm state, the audible alarm is muted by pressing the Silence button, but will ring back in about 15 minutes if the alarm condition is still present. However, the alarm messages and indicator lights persist until the fault is corrected. Afterward, the remaining relevant alarm components are cleared by pressing the Silence button.

Model SHKE8000-7 & SHKE8000-8CE - An alarm time delay of 3.5 hours is activated when the unit is first turned on or when the temperature setpoint is changed to allow adequate time for the heating or refrigeration system to recover to the setpoint. The delay is reduced to 20 minutes when the temperature is within the temperature setpoint alarm band. See Section 3 for further information on setting the tracking alarm.

Platform Stalled

Platform Stalled alerts the operator that free platform movement is inhibited.

Actual	08:41	0	23.7
Setpoints	Platform Stalled		

The motor will automatically shut off and attempt to restart after approximately 15 seconds. In the alarm state, the audible alarm is muted by pressing the Silence button but will ring back in about 15 minutes. However, the alarm messages and indicator lights will persist until the fault is corrected. The motor will continue to cycle on and off until the obstruction is removed, or the unit is turned off. On motor restart, the audible alarm and indicator lights are automatically cleared, but the alarm messages will remain until cleared by pressing the Silence button.

Caution Turn off unit power when removing any platform obstruction to prevent possible injury. ▲

Check Fuse

Check Fuse alerts the operator that there is no communication with the motor drive circuit board (historically the primary drive motor fuse has blown). In the alarm state, the audible alarm is muted by pressing the Silence button, but will ring back in about 30 minutes. However, the alarm messages and indicator lights persist until the fault is corrected. When the unit is turned on after fuse replacement, all alarm indicators are automatically cleared.

Actual	08:41	0	23.7
Setpoints	Check Fuse		

Warning Fuse replacement must be performed by qualified service personnel. See Service section. ▲

Change Configuration

To access the system Configuration menu, press the down arrow, the up arrow, then the Silence button, in that order. This screen will appear.

The screenshot shows a control interface with a data table at the top and several control buttons below. The data table is as follows:

Actual	00:00	250	37.0
Setpoints	Hold	250	37.0

Below the table are four circular icons labeled: Silence (with a speaker icon), Time (with a clock icon), Speed (with a circular arrow icon), and Temp °C (with a thermometer icon). To the right of these icons are directional arrow controls: a left arrow with '2' and 'Press', a right arrow with '1' and 'Press', and a circle with 'STOP'. At the bottom left, there is an up arrow with '3' and 'Press'.

Pressing the down arrow continues system configuration.

Actual	▼ for system configuration
Setpoints	▲ to return

Pressing the up arrow returns to the Operating Screen.

Change Configuration (continued)

During the following configuration procedures, menu options are given to either modify a setting as it appears in sequence, or scroll past to the next item. If no selection is made by pressing a button or arrow, the display reverts to the Operating Screen in about fifteen seconds. The complete configuration menu is shown in the chart at the end of this section.

Note In these procedures, values and settings for time, temperature, speeds, alarms, and so forth are shown on the display screens. These numbers are for example only and may not be the values encountered when programming your unit.

Turn the Audible Alarm On and Off

Open the Configuration menu by pressing the down arrow, the up arrow, and the Silence button, and then the down arrow once again, in the sequence shown at right.

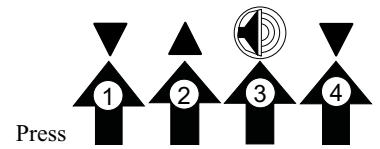

The screen at right will appear on the display.

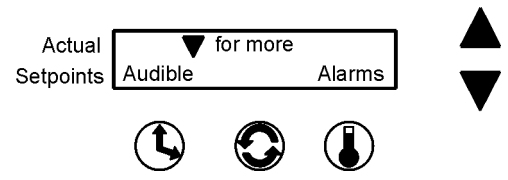

Next, press the Time button beneath Audible. The screen at right appears.

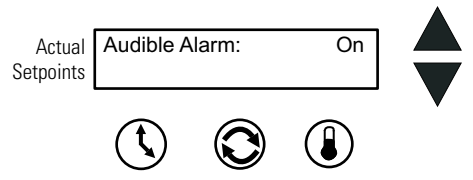

Press the up or down arrow to turn the audible alarm function on or off. Press any of the three buttons (Time, Speed or Temp) to save the new setpoint value and return the display to the previous screen, or press nothing for about 15 seconds to save the new setpoint value and return the display to the Operating Screen.

When the audible alarm is disabled, a warning message displays in the Setpoint portion of the Operating Screen as shown at right.

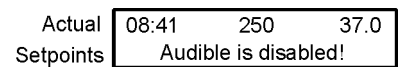

Set Alarm Limits

Three temperature alarms are programmed into the MaxQ SHKE8000 Series Stackable Orbital Shaker; Overtemperature, Undertemperature (Model SHKE8000-7 & SHKE8000-8CE), and Tracking Limits.

Set the Overtemperature Alarm

The Overtemperature alarm activates whenever the operating temperature goes above the Overtemp setpoint temperature by a few tenths of °C. This adjustable limit is set at the factory at approximately 64°C. To change this value, open the Configuration menu by pressing the down arrow, the up arrow, and the Silence button, and then the down arrow once again, in the sequence shown at right.

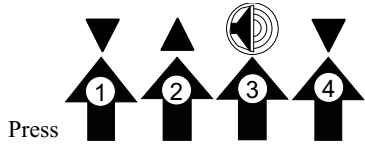

Then press the Temperature button beneath Alarms.

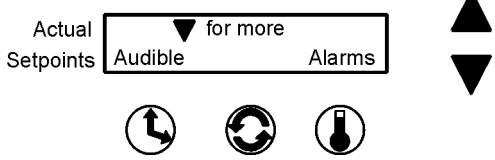

To change the Overtemperature alarm setting, press the Time button beneath Over.

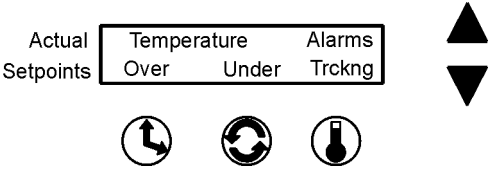

The following screen appears and the present Overtemperature alarm setting flashes.

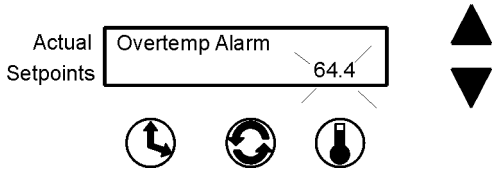

Change the Temperature setting by pressing the up or down arrow. When set, press any of the three buttons (Time, Speed, or Temp) to save the new setpoint value and return to the previous screen or press nothing for about 15 seconds to save the new setpoint value and return the display to the Operating Screen.

Note The Overtemp Alarm setpoint values are calculated from the hardware and will not include every numerical value between the upper and lower limits.

Set the Undertemperature Alarm

The Undertemperature alarm (Model SHKE8000-7 & SHKE8000-8CE) activates whenever the operating temperature drops below the Undertemperature setpoint by a few tenths of a °C. This adjustable limit is set at the factory at approximately -1°C. To change this value, open the Configuration menu by pressing the down arrow, up arrow, and the Silence button, and then the down arrow once again, in the sequence shown at right.

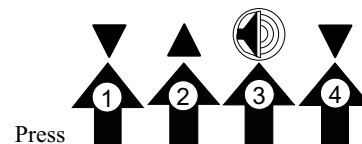

Then press the Temperature button beneath Alarms.



To change the Undertemperature alarm setting, press the Speed button beneath Under.

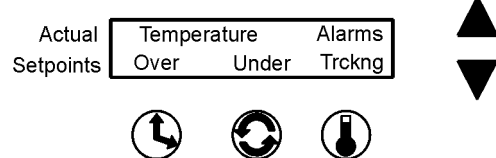

The following screen appears and the present Undertemperature alarm setting flashes.

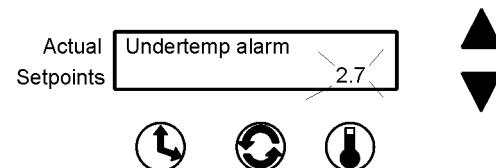

Change the Temperature setting by pressing the up or down arrow. When set, press any of the three buttons (Time, Speed, or Temp) to save the new setpoint value and return to the previous screen, or press nothing for about 15 seconds to save the new setpoint value and return to the Operating Screen.

Note The Undertemp Alarm setpoint values are calculated from the hardware and will not include every numerical value between the upper and lower limits.

Set the Temperature Alarm Tracking Limit

The Temperature Tracking alarm activates whenever the operating temperature goes above or below the setpoint temperature by a user selectable value in the range of 1°C to 20°C. The limit is set at the factory as 10°C above and below the temperature setpoint.

Note The above and below limits are always the same value.

To change this limit, open the Configuration menu as in the previous alarm procedures, by pressing the down arrow, up arrow, and the Silence button, and then the down arrow once again, in the sequence shown at right.

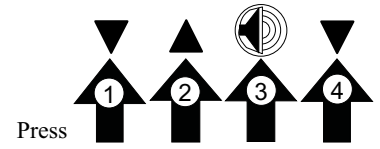

Then press the Temperature button beneath Alarms.

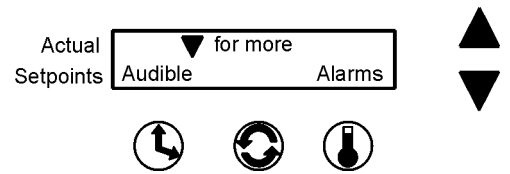

To change the Temperature Tracking alarm setting, press the temperature button beneath Tracking (Trcking).

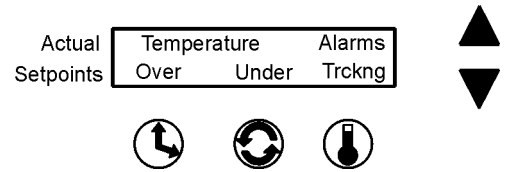

The screen at right appears and the present Temperature Tracking alarm limit setting flashes.

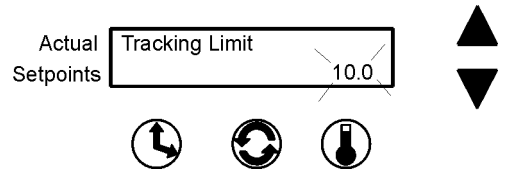

Change the Temperature Tracking limit by pressing the up or down arrow. When set, press any of the three buttons (Time, Speed, or Temp) to save the new setpoint value and return to the previous screen, or press nothing for about 15 seconds to save the new setpoint value and return the display to the Operating Screen.

Remote Alarm System

Most of the alarm states described previously (Table 2-2, pg 2-7) can alert a remote alarm monitoring system through an internal SPDT relay connected to an RJ-11 connector on the left front of the shaker, behind the kick panel. Refer to ‘Connect the Remote Alarm’ in Section 1. For the convenience of the laboratory, these remote alarms can be individually turned on or off. Any of the remote alarms that are set to On will activate the internal relay.

Note The Overtemp Shutdown, Undertemp Shutdown, Platform Stalled, and Check Fuse remote alarms cannot be deactivated.

To set the remote alarms to On or Off, open the Configuration menu by pressing the down arrow, up arrow, and the Silence button, and then the down arrow three times, in the sequence shown below.

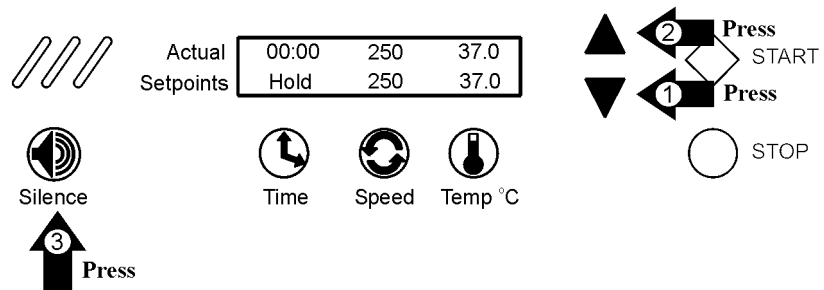

The screen shown at the right will appear on the display.

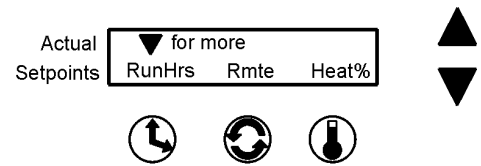

Press the Speed button beneath Remote (Rmte). The alarms will be shown in the following sequence:

Cycle Complete

Toggle the Cycle Complete alarm with either the up (On) arrow or the down (Off) arrow. Pressing the Temp button beneath Next advances the display to the next alarm, saving the Cycle Complete alarm setting to memory. If no buttons are pressed, the display will automatically return to the Operating Screen after about 15 seconds, saving the selection to memory.

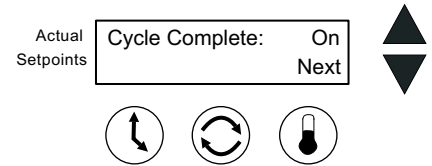

Power Failure

Toggle the Power Failure alarm with either the up (On) arrow or the down (Off) arrow. Pressing the Temp button beneath Next advances the display to the next alarm, saving the Power Failure setting to memory. If no buttons are pressed, the display will automatically return to the Operating Screen after about 15 seconds, saving the selection.

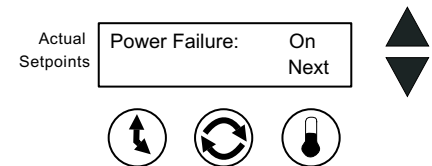

RPM Tracking

Toggle the RPM Tracking alarm with either the up (On) arrow or the down (Off) arrow. Pressing the Next (temperature) button advances the display to the next alarm, saving the RPM Tracking setting to memory. If no buttons are pressed, the display will automatically return to the Operating Screen after about 15 seconds, saving the selection to memory.

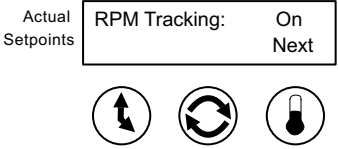

Check Belt

Toggle the Check Belt alarm with either the up (On) arrow or the down (Off) arrow. Pressing the Temp button beneath Next advances the display to the next alarm, saving the Check Belt setting to memory. If no buttons are pressed, the display will automatically return to the Operating Screen after about 15 seconds, saving the selection to memory.

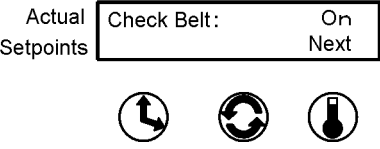

Temperature Sensor Fault

Toggle the Sensor Fault alarm with either the up (On) arrow or the down (Off) arrow. Pressing the Temp button beneath Next advances the display to the next alarm, saving the On/Off setting to memory. If no buttons are pressed, the display will automatically return to the Operating Screen after about 15 seconds, saving the selection to memory.

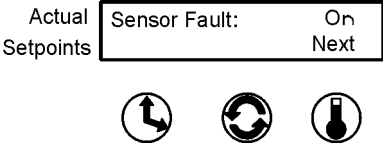

Temperature High or Low

Toggle the Temp High/Low alarm with either the up (On) arrow or the down (Off) arrow. Pressing the Temp button beneath Return returns the display to the previous screen, saving the On/Off setting to memory. If no buttons are pressed, the display will automatically return to the Operating Screen after about 15 seconds, saving the selection to memory.

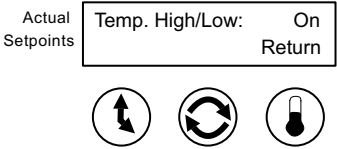

Whether the unit has been operated in the Hold or Countdown modes, and/or has been turned off and unplugged many times, the microprocessor control system maintains a running total of platform operating hours.

View Total Operating Hours

To view this information, open the Configuration menu by pressing the down arrow, up arrow, and the Silence button, and then the down arrow three times, in the sequence shown below.

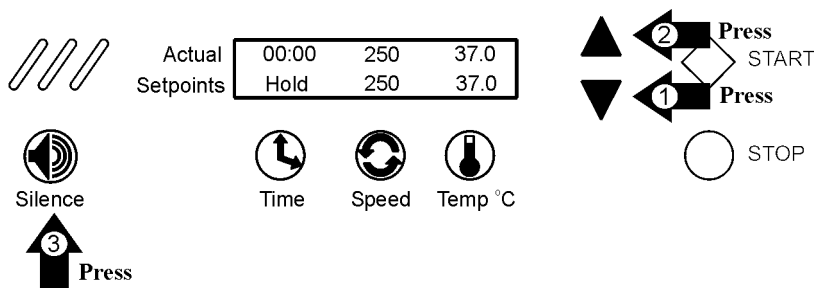

The screen at the right will appear on the display.

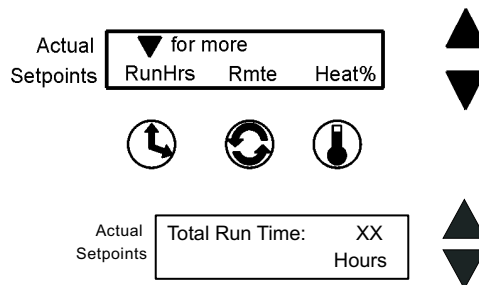

Pressing the Time button beneath RunHrs shows the total accumulated run hours as displayed at right. When finished, press any of the three buttons (Time, Speed, or Temp) to save the new setpoint value and return to the previous screen, or press nothing for about 15 seconds to save the new setpoint value and return to the Operating Screen.

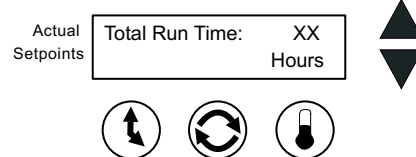

Heat %

Heat percentages are intended for factory use only, and can be helpful in troubleshooting the heat control system.

To view this information, open the Configuration menu by pressing the down arrow, up arrow, and the Silence button, and then the down arrow three times, in the sequence shown below.

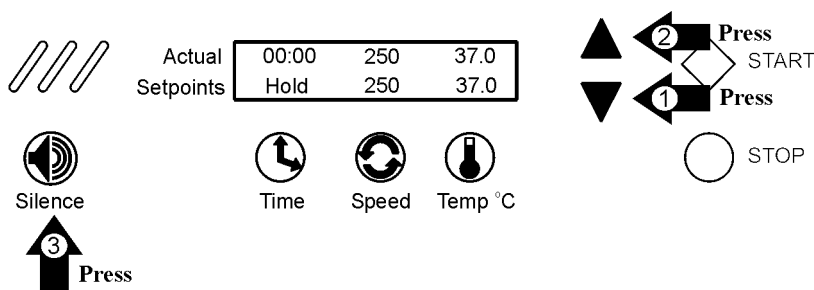

The screen shown at the right will appear on the display.

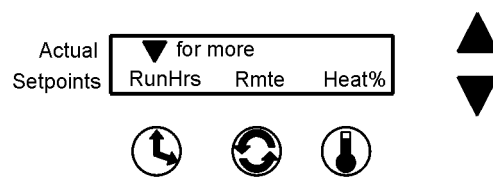

Press the Temp button beneath Heat %.

Heat % (continued)

Main Heat % is the percentage of time that the chamber heater is turned on during a five second period. Example: If the heater is being cycled on for two seconds and off for three seconds, the Heat % value is 40 percent.

Main:	XXX.X %
Door:	XXX.X %

Door Heat % is the percentage of time that the door glass heater is operating during a five second period (Model SHKE8000-7 & SHKE8000-8CE).

When finished, press any of the three buttons (Time, Speed, or Temp) to save the new setpoint value and return to the previous screen, or press nothing for about 15 seconds to save the new setpoint value and return to the Operating Screen.

Software Version

Software Version is for factory use only and will be important if troubleshooting the microprocessor programming is ever necessary. To view this information, open the Configuration menu by pressing the down arrow, up arrow, and the Silence button, and then the down arrow four times, in the sequence shown below.

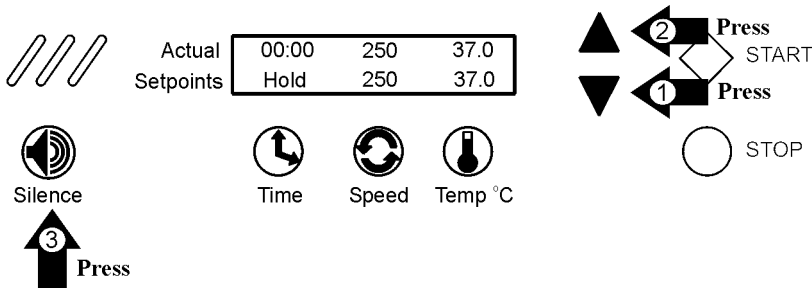

The screen at right will appear on the display.

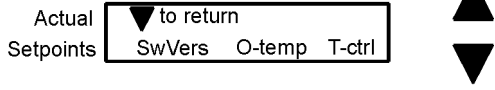

Press the Time button beneath SwVers and the next screen will appear, showing the appropriate MaxQ SHKE8000 Series software version in the control system memory, where X is the release level and y is the revision level.

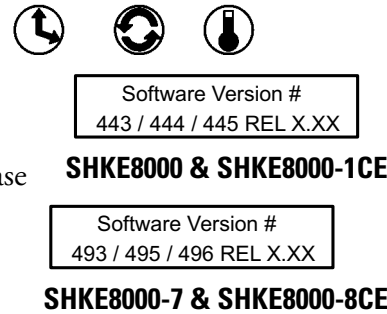

When finished, press any of the three buttons (Time, Speed, or Temp) to save new setpoint value and return to previous screen, or press nothing for about 15 seconds to save new setpoint value and return to Operating Screen.

Overtemp Sensor Reading

Overtemp Sensor Reading is for factory use only and will be important if troubleshooting is ever necessary.

Overtemp Sensor

To view this information, open the Configuration menu by pressing the down arrow, up arrow, and the Silence button, and then the down arrow four times, in the sequence shown below.

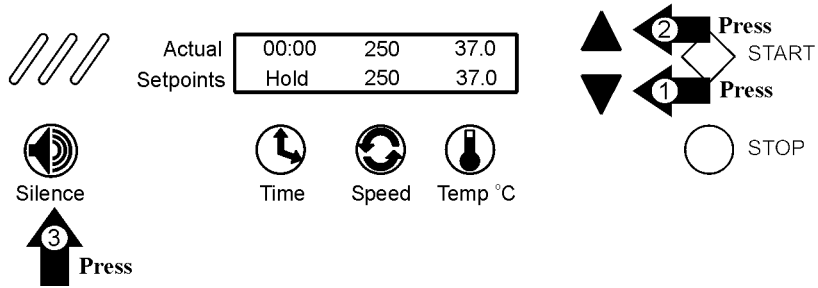

The screen at the right will appear on the display.

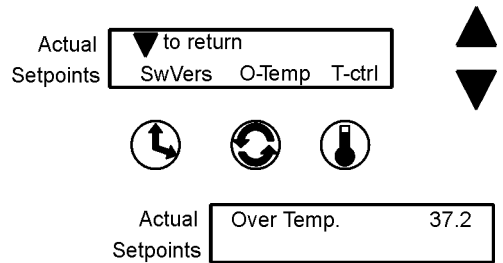

Press the Speed button beneath O-Temp and the screen at right will appear, showing the temperature being read by the Overtemp sensor.

When finished, press any of the three buttons (Time, Speed, or Temp) to save the new setpoint value and return to the previous screen, or press nothing for about 15 seconds to save the new setpoint value and return to the Operating Screen.

Temperature Control

This control allows the unit to be operated without heat or refrigeration.

To turn the Temperature Control on or off, open the Configuration menu by pressing the down arrow, the up arrow, the Silence button, and then the down arrow button four times, in the sequence shown below.

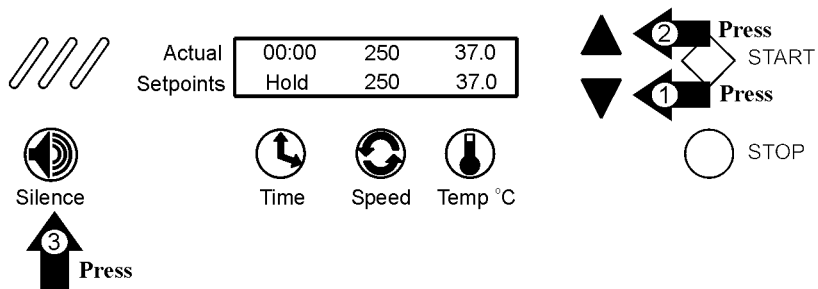

Temperature Control (continued)

The screen shown at the right will appear on the display.

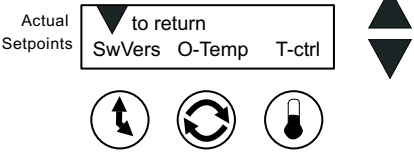

Press the Temperature button beneath T-ctrl and the screen shown at the right will appear.

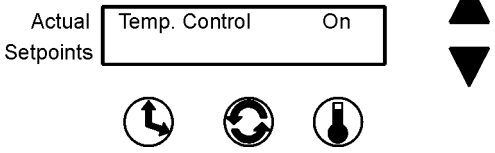

Toggle the Temperature Control with either the up (On) arrow or the down (Off) arrow.

When finished, press any of the three buttons (Time, Speed, or Temp) to save the new setpoint value and return to the previous screen, or press nothing for about 15 seconds to save the new setpoint value and return to the Operating Screen.

Defrost Control

Defrosting of Model SHKE8000-7 & SHKE8000-8CE takes place automatically about every eight hours, when the setpoint temperature is 10°C or less. When turned on, the defrost control turns off the refrigeration system and increases the cabinet temperature until it reaches the 12°C or 14°C defrost setpoint. At that time, the system turns the refrigeration system back on. The defrost cycle will continue for about thirty seconds. Then the cabinet circulation fan is turned back on and the Defrost message is cleared from the display.

To turn the Defrost Control On and Off, open the Configuration menu by pressing the down arrow, up arrow, and the Silence button, and then the down arrow five times, in the sequence shown below.

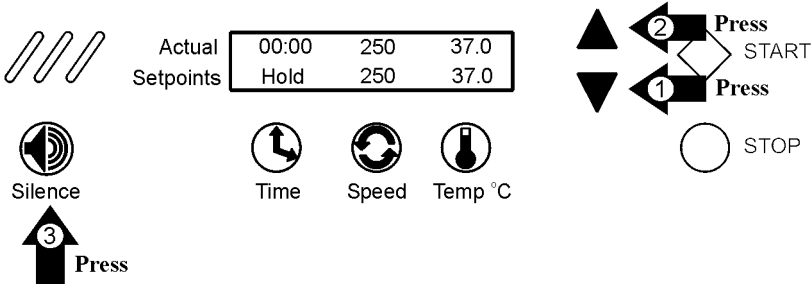

The screen shown at right appears on the display.

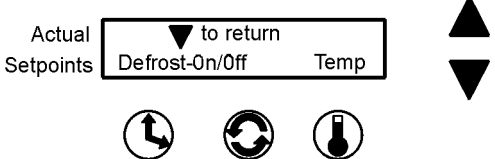

Press the Speed button beneath On/Off and the screen on the right appears.

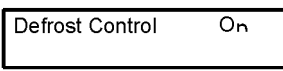

Defrost Control (continued)

Toggle the Defrost Control with either the up (On) arrow or the down (Off) arrow.

When finished, press any of the three buttons (Time, Speed, or Temp) to save the new setpoint value and return to the previous screen, or press nothing for about 15 seconds to save the new setpoint value and return to the Operating Screen.

Set the Defrost Temperature

To toggle the Defrost temperature between 12°C and 14°C, open the Configuration menu by pressing the down arrow, up arrow, and the Silence button, and then the down arrow five times, in the sequence shown at right.

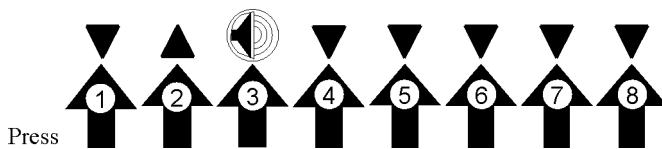

The screen shown at right will appear on the display.

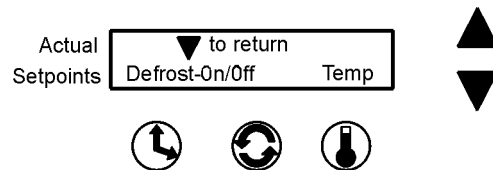

Press the Temperature button beneath the Temp button and the screen at right will appear.

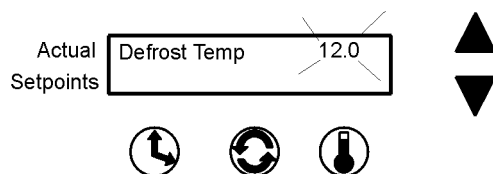

Toggle between the two Defrost temperatures using the up and down arrows.

When finished, press any of the three buttons (Time, Speed, or Temp) to save the new setpoint value and return to the previous screen, or press nothing for about 15 seconds to save the new setpoint value and return to the Operating Screen.

- Selecting Hold or Countdown Time
- Setting Operating Speed
- Setting Operating Temperature
- Setting Hold Temperature

Orbital Shaker Menu Map

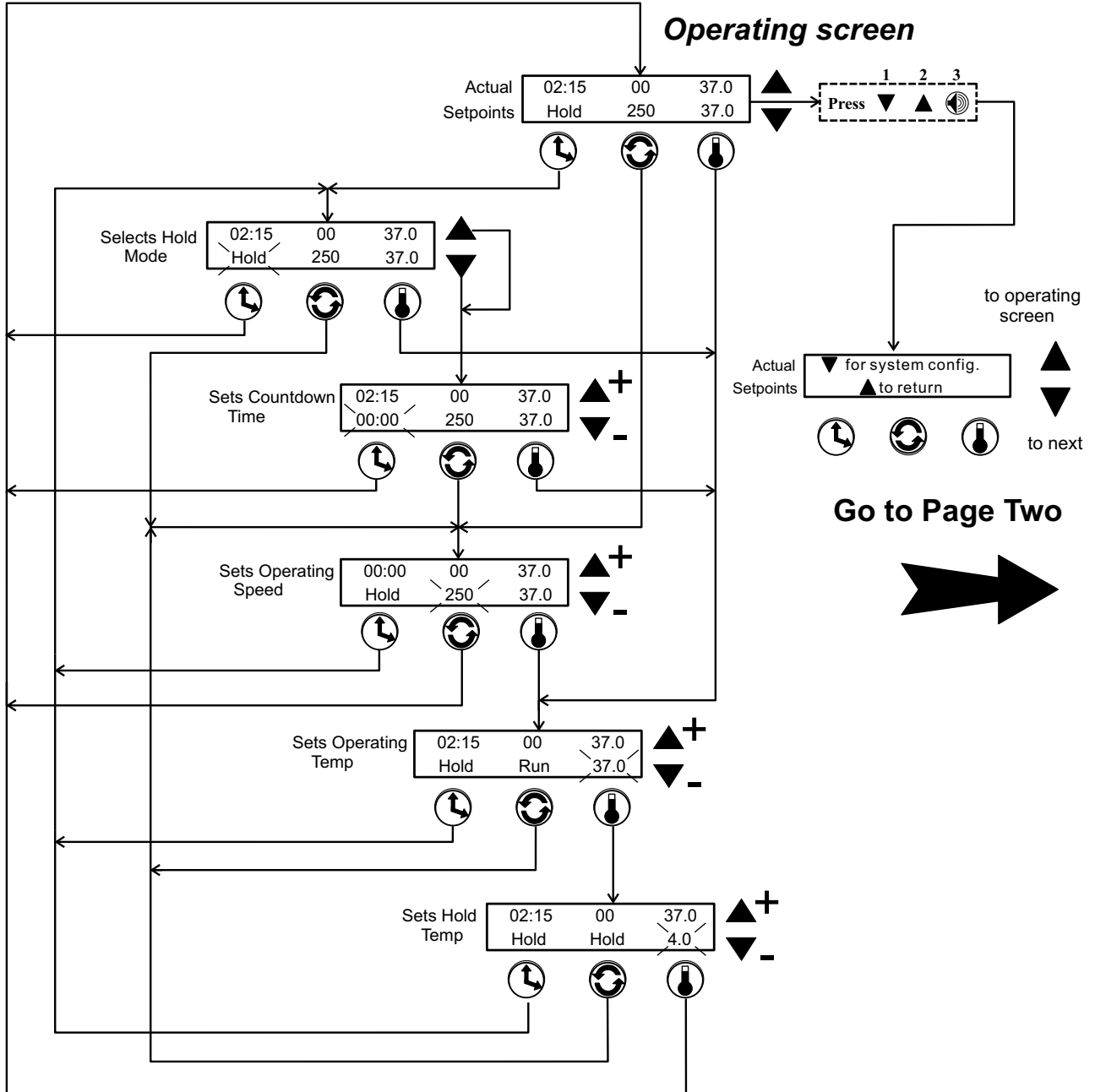

Note: Numerical values and alarm settings shown here are for reference only and may not match any specific shaker

Page One

Turning the Audible Alarm On and Off

Orbital Shaker Menu Map

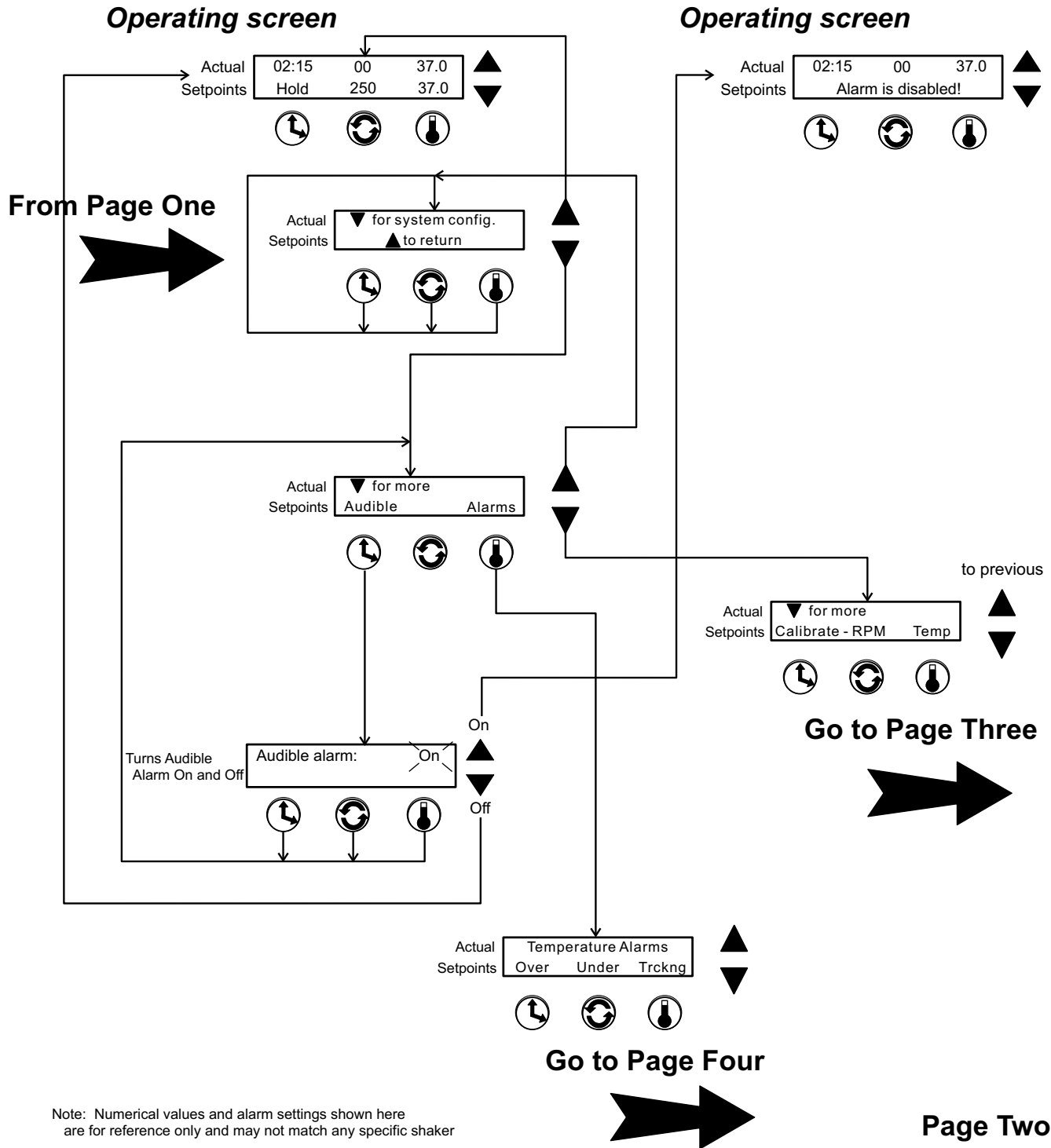

- Calibrating Speed
- Calibrating Temperature
- Viewing Total Unit's Running Time
- Viewing Percent Heat

Orbital Shaker Menu Map

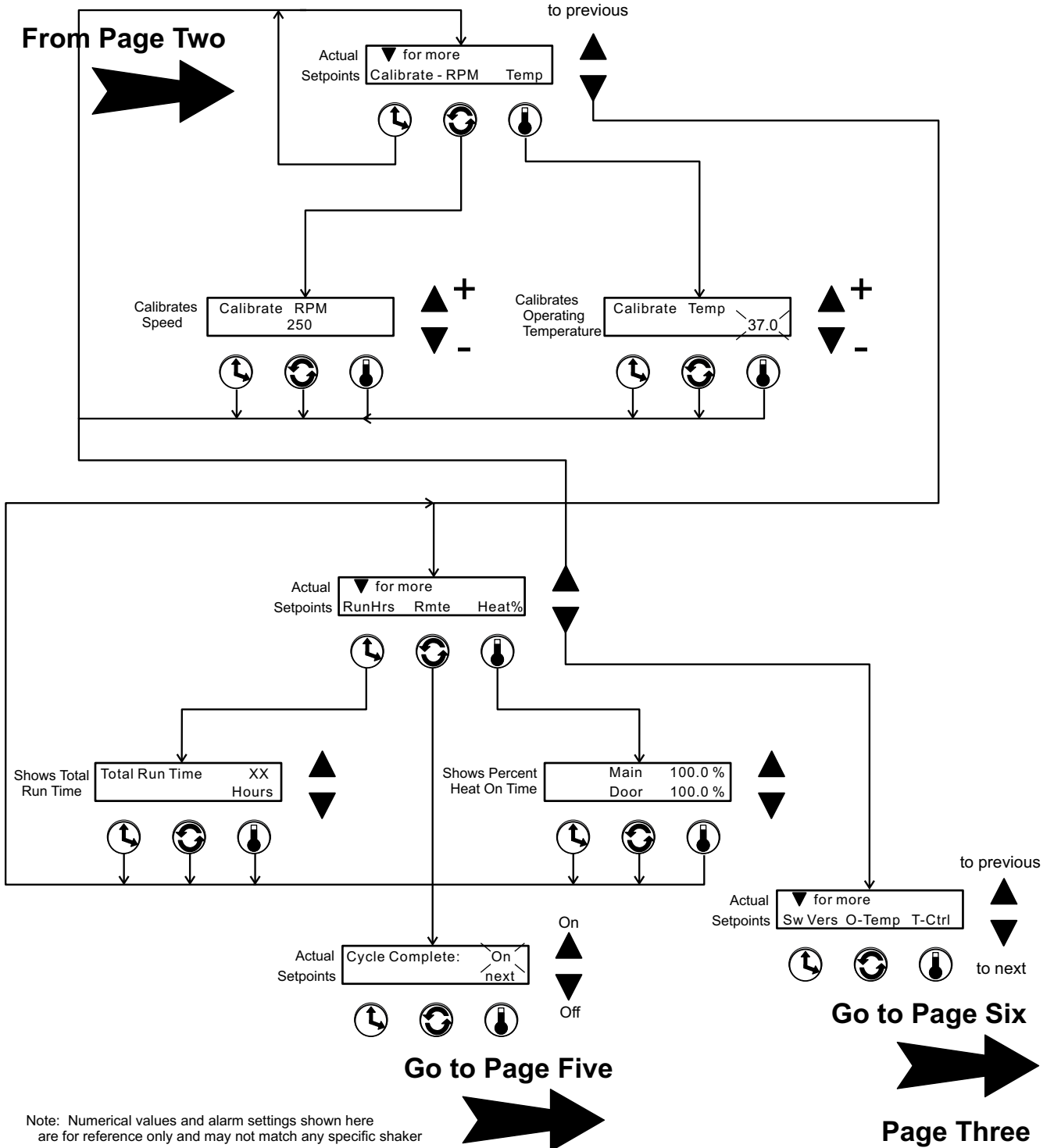

Setting Overtemperature Alarm Value
Setting Undertemperature Alarm Value
Setting Temperature Tracking Limit Value

Orbital Shaker Menu Map

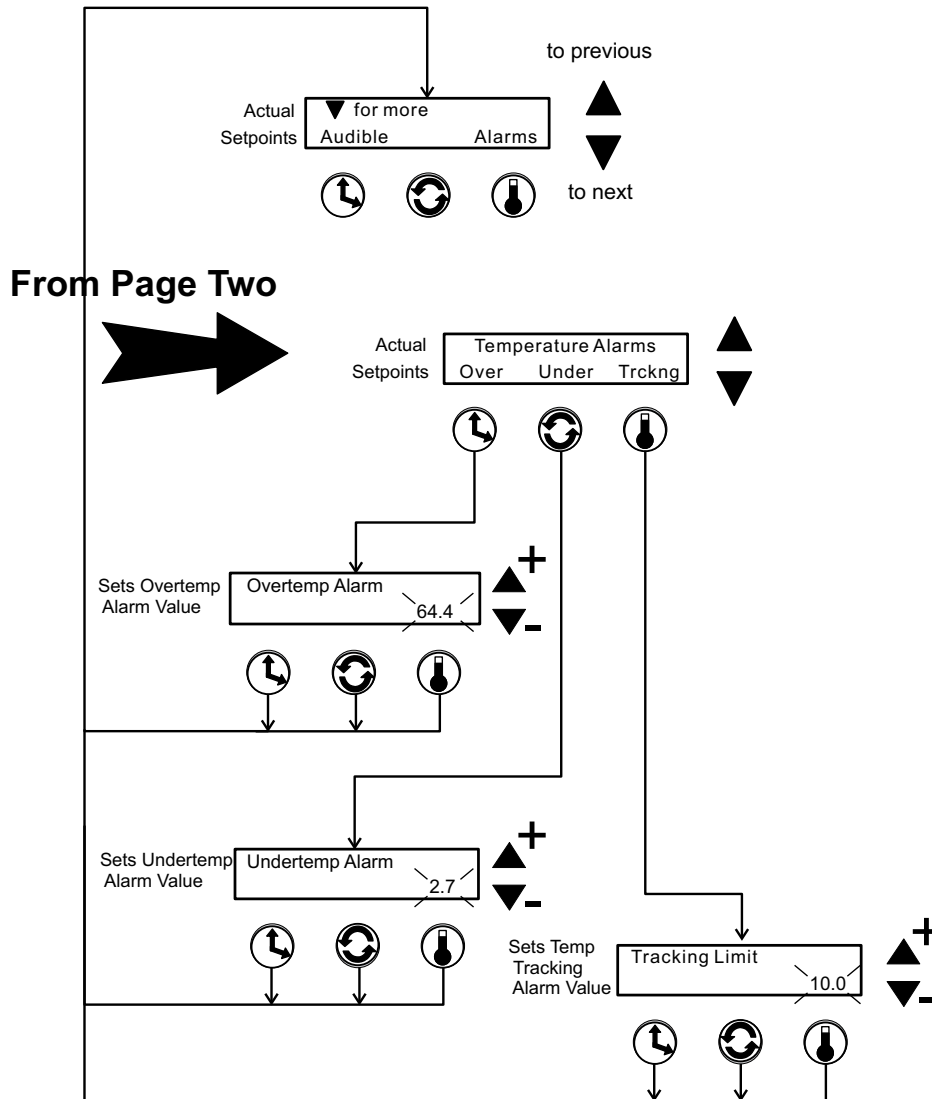

Note: Numerical values and alarm settings shown here are for reference only and may not match any specific shaker

Turning the Individual Remote Alarms
On and Off

Orbital Shaker Menu Map

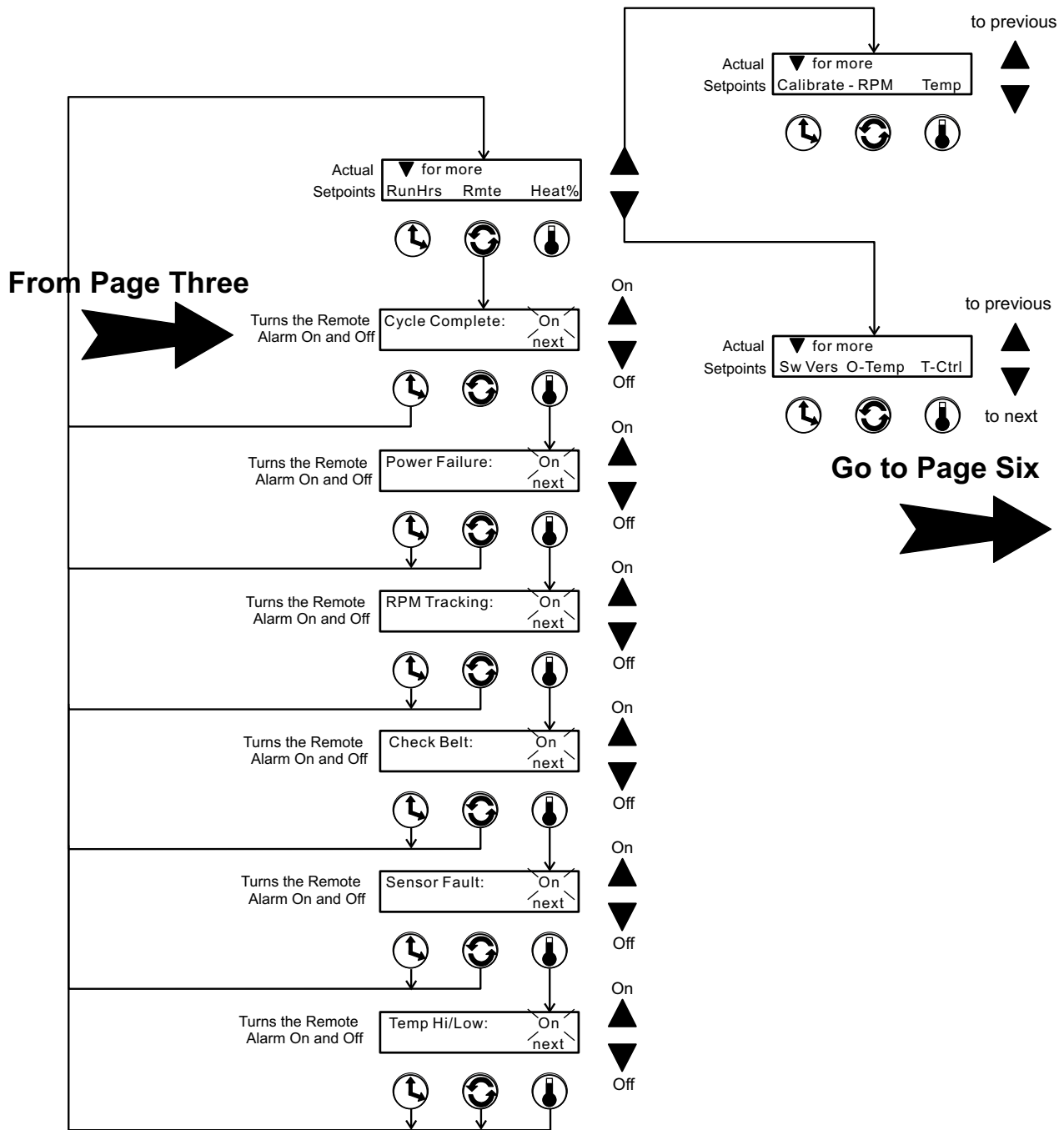

Note: Numerical values and alarm settings shown here are for reference only and may not match any specific shaker

- Viewing Software Version
- Viewing Overtemperature Sensor Reading
- Turning Temperature Control On and Off
- Turning Defrost Control On and Off
- Setting Defrost Temperature (12.0° or 14.0°)

Orbital Shaker Menu Map

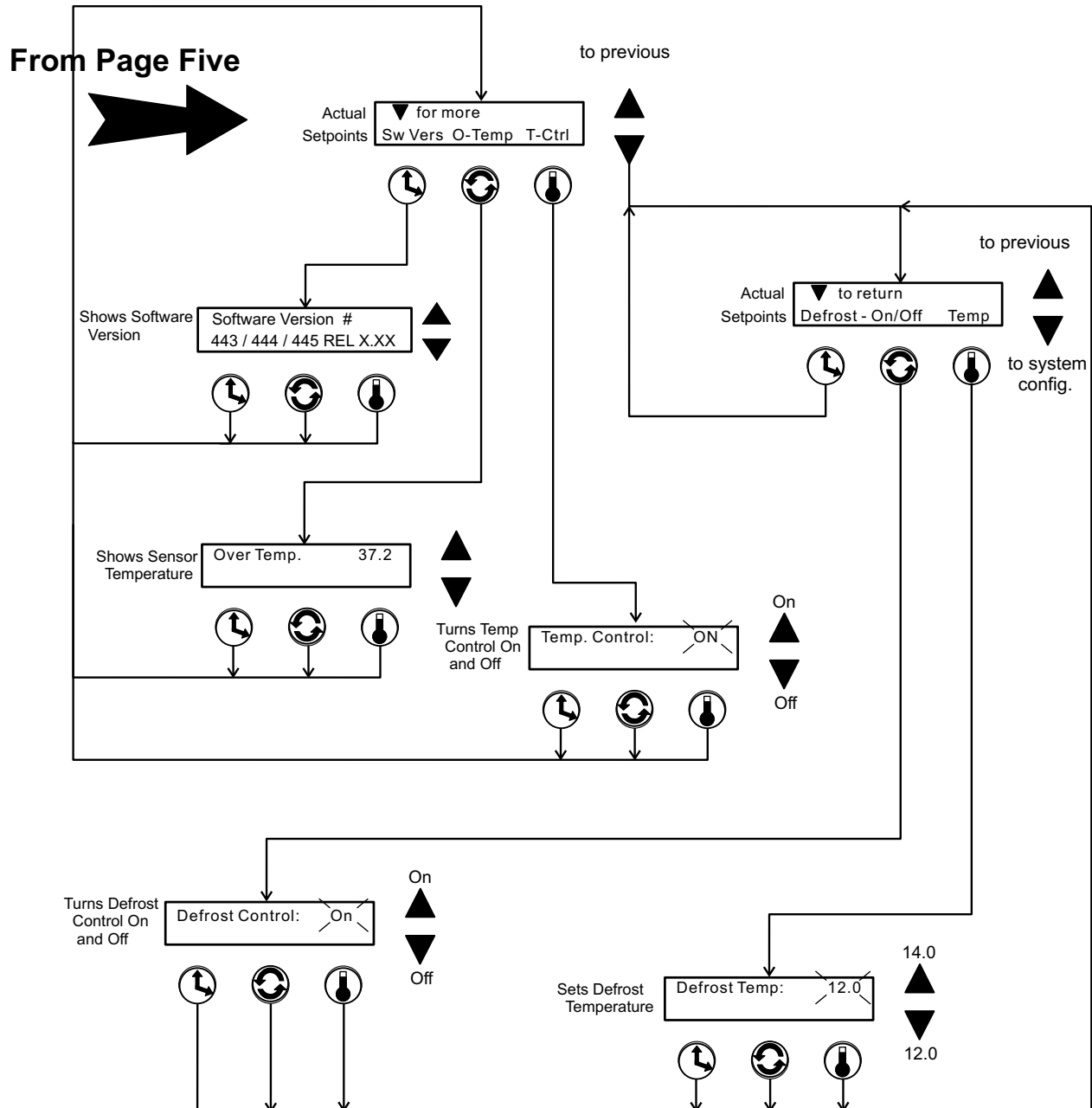

Note: Numerical values and alarm settings shown here are for reference only and may not match any specific shaker

Section 3 Maintenance

The MaxQ SHKE8000 Series Shakers use a brushless DC motor and oversized, permanently lubricated bearings which require no maintenance.

Platform and Cabinet Cleaning

The anodized brushed aluminum platform and powder-coated steel cabinet surfaces can be cleaned with common laboratory materials. However, liquids should not be allowed to enter the shaker cabinet from under the platform. All spills should be cleaned up immediately. If necessary, remove the platform. Follow 'Platform Adjustments' procedure in Section 4, when re-installing the platform.

Quick Release Platform

If the platform makes undue vibration noise during operation, adjustments may be needed.

1. Pull universal platform from the cabinet. At the back of the platform are two tapered pins (Figure 3-1).

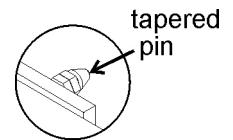

Figure 3-1. Pin

2. Loosen the nut closest to the platform. Turn the center nut slightly to extend the pin away from the platform. A quarter-turn or less is a good first test.
3. While holding the center nut, tighten the nut closest to the platform back against the pin mounting block.
4. Align the guide rails to the outer edge of the quick-release platform. Slide the platform into the cabinet.
5. Turn the unit on, and with the unit empty, set the speed to 300 RPM. Allow the unit to run for several minutes. If the vibration is normal, return the unit to service. If not, repeat steps above.

Platform Handle Adjustment

1. Grasp the platform handle and pull up on the inner release bar to move the handle to a horizontal (down) position.
2. Remove the screws from the sides of the handle, as indicated in Figure 3-2. Remove the handle.
3. Turn the adjustment screws just one-half turn clockwise to increase the clamping force, or one-half turn counterclockwise to reduce the clamping force.
4. Reassemble the handle and install the side screws. Slide the platform into the shaker chamber. Place the handle into a vertical position.
5. Close the door, and with the unit empty, set the speed to 300 RPM. If there is undue vibration noise, repeat the steps above. If not, return the unit to service.

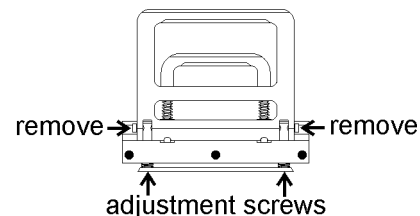

Figure 3-2. Screws

Control Panel

The control panel uses sealed push buttons and liquid crystal display. It may be cleaned with a mild detergent and dried with a soft cloth.

Clean/Replace Condenser Air Filter

The condenser air filter is located behind the grille on the front of the refrigeration assembly attached to the side of the shaker (Model SHKE8000-7 & SHKE8000-8CE). The grille is secured by four press-in type retainers at the top and bottom. Remove it by grasping the edge of the cover and pulling outward.

The air filter is held in place with a flange around its perimeter (Figure 3-3) and is easily removed. It may be replaced, or washed in water with a mild detergent and dried between two lint-free towels.

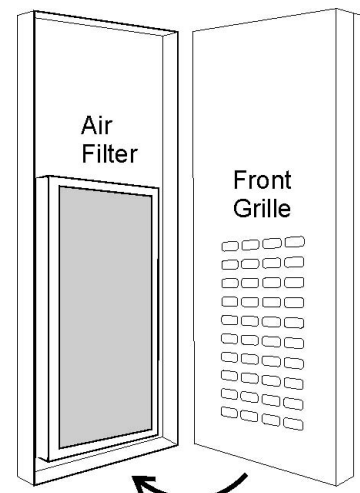

Figure 3-3. Inside Front Grille

PREVENTIVE MAINTENANCE

Shakers

Your equipment has been thoroughly tested and calibrated before shipment. Regular preventive maintenance is important to keep your unit functioning properly. The operator should perform routine cleaning and maintenance on a regular basis. For maximum performance and efficiency, it is recommended the unit be checked and calibrated periodically by a qualified service technician.

The following is a condensed list of preventive maintenance requirements. See the specified section of the operating manual for further details.

We have qualified service technicians, using NIST traceable instruments, available in many areas. For more information on Preventive Maintenance or Extended Warranties, please contact Technical Services.

Cleaning and calibration adjustment intervals are dependent upon use, environmental conditions and accuracy required.

Tips for all shakers

- Use only our standard flat-head screws for flask clips.
- Use only our standard round-head screws for test tube racks, holders and utility trays.

Section 3
Maintenance

Refer to Manual Section	Action	Daily	Monthly	Yearly
3	Inspect the air filter. Clean as needed		✓	
--	Clean the unit with mild detergent and wipe dry as needed		✓	
--	Clean the window with a glass cleaner and wipe dry		✓	
--	Check under the platform for broken glass or other debris.		✓	
--	Inspect and/or clean the condenser, if present.			✓
--	* Verify operation of the circulation fan motor			✓
2	* Check and document calibration of temperature, alarms, speed and time, as applicable			✓
4	Change the HEPA filter, as needed			✓

* Qualified service technicians only

Section 4 Service

Caution The procedures outlined in this section must be performed by persons experienced in servicing and maintaining laboratory equipment. Lockout and tagout electrical power connections whenever removing cabinet panels or working on electrical or motor control components. To avoid damage to solid state electrical components, proper grounding techniques must be observed whenever working on this shaker. ▲

With the exception of the chamber air filter, Model SHKE8000 Series Orbital Shakers contain no user-serviceable components.

Alarms and Alarm Conditions

If the microprocessor control system senses a fault, malfunction or abnormal operating condition, alarm messages appear on the liquid crystal display. These messages are helpful if service or repair assistance should become necessary. Refer to Table 4-1 below and the alarm matrix at the end of this section.

Table 4-1. Alarms

Alarm Message	Fault Condition
Overtemp Shutdown	System shutdown due to over temperature condition
Undertemp Shutdown (SHKE8000-7JPN only)	System shut down due to under temperature condition
Main Temp Sensor	Temperature sensor failed
Over Temp Sensor	Temperature sensor failed
Temperature is High	Temperature tracking sensed higher temperature than setting
Temperature is Low	Temperature tracking sensed lower temperature than setting
RPM is High	RPM tracking has sensed shaker speed is higher than setpoint
RPM is Low	RPM tracking has sensed shaker speed is lower than setpoint
Power Failure	Power failed during shaker operation, or shaker power is off for more than 1.5 hours
Cycle Complete	Blank screen, end of countdown cycle reached
Check Belt	Motor V-belt is broken or slipping
Audible is Disabled!	Continuously notifies operator that audible alarm is disabled
Platform Stalled	Free movement of platform is obstructed
Check Fuse	Power loss to motor drive circuit board, most likely the primary drive motor fuse is blown

Change the Chamber Air Filter

The chamber air filter is located on the left side of the chamber and is accessed by first removing the endplate. Eight screws secure the endplate and filter assembly to the chamber wall. Refer to Figure 4-1 below.

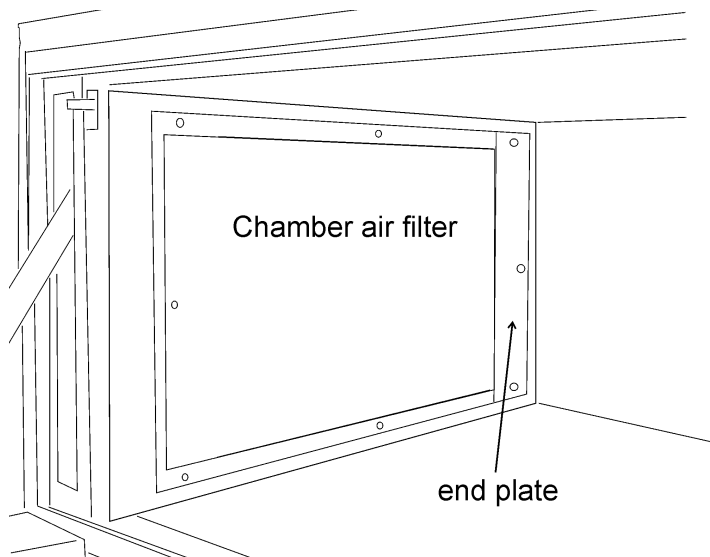

Figure 4-1. Filter Location

Remove the three screws from each end of the filter assembly first. Set the screws and endplate aside. Then remove the top and bottom screws from the filter and discard the filter.

To install the new filter, secure the filter first at the top and bottom with the two screws. Then secure the front edge of the filter with the three screws and the far end with the endplate and screws as above.

If the Shaker Will Not Operate

If the shaker platform will not operate with the unit plugged in and the power switch turned on, the following conditions may be present:

- The door may be open - Lift the door to its fully closed position.
- Time countdown reached - Reset the time, or change to continuous operation (Hold).

Replace the Door Stop

1. Turn the unit off and disconnect from the power source.
2. Pull the door of the shaker fully open.
3. At the bottom of the door stop, where it attaches to the door bracket, is a retaining clip which must be removed (Figure 4-2).

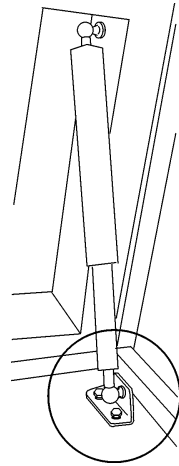

Figure 4-2.
Locate Clip

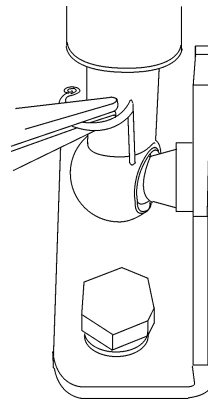

Figure 4-3.
Rotate Clip

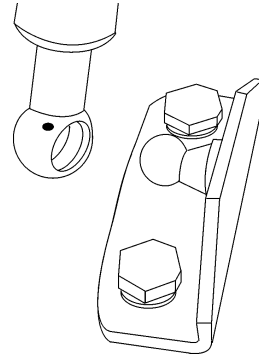

Figure 4-4.
Disengage Ball

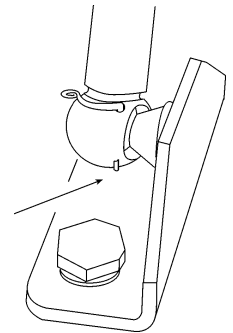

Figure 4-5.
Position Clip

4. Using needle-nose pliers, rotate the retaining clip outward, then pull the clip out (Figure 4-3).
5. Locate the retaining clip at the top of the door stop. Rotate the clip away from the stop and remove.
6. Remove the door stop from the balls on each mounting bracket, top and bottom (Figure 4-4). Discard the damper inside the assembly (see assembly drawing 440-200-5 toward the end of the English manual).
7. Fit the new damper into the assembly, as previously.
8. Install the new door stop as it was removed. Make sure each retaining clip is installed so that the tip of the clip is showing at the bottom of the door stop (Figure 4-5).

Spare Fuses

Two fuses are located on the front of the relay enclosure located in the lower right area of the stackable cabinet. Refer to Table 4-2 for a list of their electrical ratings, part numbers and application. Gain access to the relay enclosure by removing the kick panel on the lower front of the cabinet. It is held in place by a screw on each end of the panel and two tabs at the top. To access the fuses, remove the retainer/cover plate holding the relay enclosure in place. See Figure 4-6.

Table 4-2. Fuses

MaxQ SHKE8000 Series Shakers		
Rating	Application	Part Number
0.25 amp	Main Power Relay Board	230144
1.6 amp	Drive Motor	230145

Caution Do not substitute! Replace these fuses only with fuses of identical electrical ratings. ▲

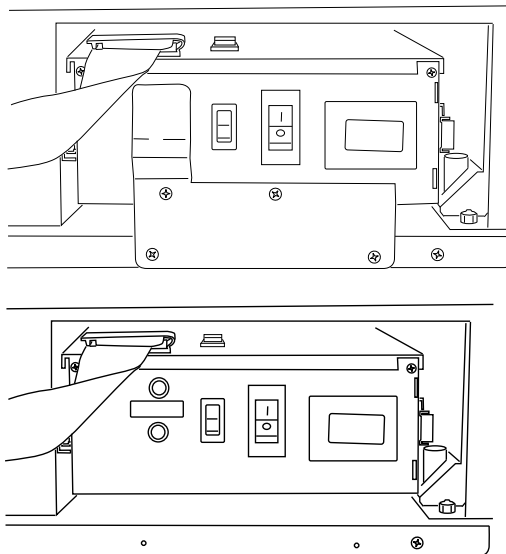

Figure 4-6. Relay Enclosure with and without Cover Plate

Circuit Boards

Four circuit boards control the Orbital Shaker. Three boards are located in the relay tray compartment, the fourth is behind the liquid crystal display. Refer to the relay tray illustrations on the following pages.

Temperature Sensors

Two temperature sensors are located on the air intake grille on the right side of the chamber (Figure 4-7). To access these sensors, remove the protective cover, then disconnect the sensors from their respective clips.

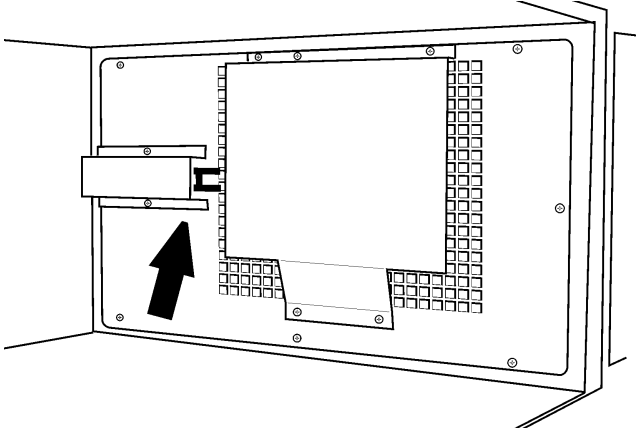

Figure 4-7. Temp Sensor Location

Heater Element Circuit Breaker

Warning Only qualified service personnel should perform this procedure.

Warning Remove and lockout electrical power when working on or near the heating element connectors. Allow sufficient time for the heating elements to cool before reaching into that area. ▲

A manual reset circuit breaker is located between the heating element electrical connectors on the top of the heater assembly (Figure 4-8). The heating element is attached to the duct wall behind the grille. To access the heating element and this circuit breaker, remove the eight Phillips screws securing the right side grille to the chamber wall (Figure 4-7).

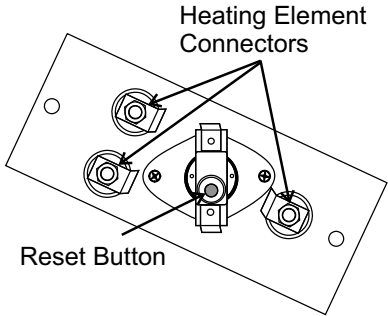

Figure 4-8. Circuit Breaker Reset

Tune the Cabinet

Make sure the shaker is in place, level and the platform installed. With the unit turned on and empty, set the speed to 300 RPM. Kneeling in front of the shaker, lightly touch the lower left and right corners of the cabinet. If one side seems to vibrate more than the other, raise or lower the leveling foot using the 3/4" open end wrench supplied in the parts bag. Continue this "fine tuning" until the vibrations are reduced as far as possible. Ensure locking nuts are secured when complete.

Caution Do not extend leveling feet more than 1/4 inch from the bottom of the unit. When the unit is leveled and tuned, with the leveling feet locked in place, the adjustment and locking nuts should be no further apart than 1/4 inch. ▲

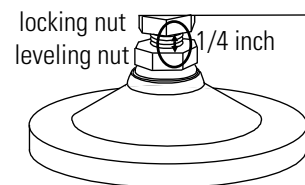

Figure 4-9. Locked Feet

Platform Adjustments

Each platform is adjusted to fit the unit with which it is shipped. In the instance of replacement or additional platforms, adjustments may be required. To check for undue platform vibration noise during operation, see the steps following.

Platform Vibration Adjustment

1. Make sure the platform handle is in the vertical position and the door is closed. The unit should also be leveled and tuned.
2. With the unit turned on and empty, set the speed to 300 RPM. Allow the shaker to run for several minutes. If the vibration is normal, return the unit to service. If not, continue to Step 3.

3. Remove the platform from the chamber. At the back of the platform are two tapered pins (Figure 4-10).
4. Loosen the nut closest to the platform. Turn the center nut slightly to extend the pin away from the platform. A quarter-turn or less is a good first test.

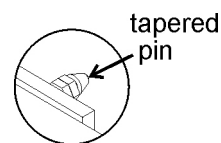

Figure 4-10. Pin

5. While holding the center nut, tighten the nut closest to the platform back against the pin mounting block. Install the platform into the chamber. Note pin locators (Figure 4-11) on quick-release platform.

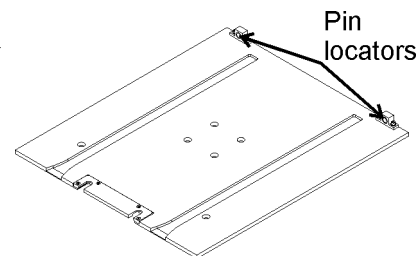

Figure 4-11. Pin Locators

6. With the unit turned on and empty, set the speed to 300 RPM. Allow shaker to run for several minutes. If the vibration is normal, return the unit to service. If not, repeat Step 4.

Handle Adjustment

1. Grasp the platform handle and pull up on the inner release bar to move the handle to a horizontal (down) position.
2. Remove the screws from the sides of the handle, as indicated in Figure 4-12. Remove the handle.
3. Turn the adjustment screws just one-half turn clockwise to increase the clamping force, or one-half turn counterclockwise to reduce the clamping force.
4. Reassemble the handle and install the side screws. Slide the platform into the shaker chamber. Place the handle into a vertical position.
5. Close the door and with the unit empty, set the speed to 300 RPM. If there is undue vibration noise, repeat the steps above. If not, return the unit to service.

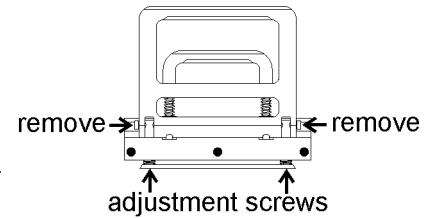
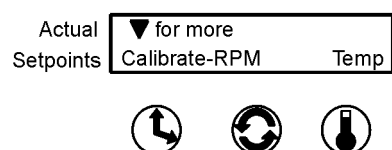

Figure 4-12. Adjustment

Calibrate the Temperature

1. Place a 250ml Erlenmeyer flask (filled with approximately 100ml of liquid) in approximately the geometric center of the platform.
2. Suspend an independent temperature measuring device of known accuracy into the flask. The sensor should be submerged in the liquid but not in contact with the bottom or sides of the flask.
3. Adjust the shaker temp setpoint at desired calibration temperature.
4. Set the shaking speed setpoint to 75 RPM.
5. Start the unit and allow a minimum of 2 hours stabilization of cabinet and flask liquid.

6. Enter Calibration mode by pressing the down arrow, the up arrow, the Silence button. Then press the down arrow twice. The screen at right will appear on the display:



7. Press the Temperature button beneath Temp.

8. Using the up and down arrows, increase or decrease the temperature value to match the independent, accurate temperature measuring device.

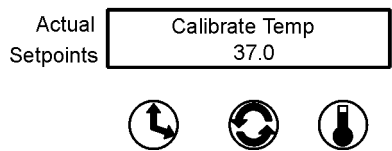

9. When complete, press the Time, Speed, or Temp button to save the setting. The display will return to the Calibrate - RPM Temp screen. (Or, if nothing is pressed for about fifteen seconds, the display will return to the Operating Screen and the setting will be automatically saved to memory.)
10. Allow the cabinet to re-stabilize for 1 hour. Recheck temperature. If necessary, return to Step 6 until no additional adjustments are needed.
11. Temperature calibration is now complete. Remove calibration equipment and resume use.

Calibrate Platform Speed (RPM)

An external calibrated speed measuring device can be used to adjust the actual platform speed so that the unit setpoint speed matches the external device measurement. Calibration of the platform speed is performed at the factory at 250 RPM. To change the actual platform speed, open the Configuration menu by pressing the down arrow, up arrow, and the Silence button, and then the down arrow once again, in the sequence shown below.

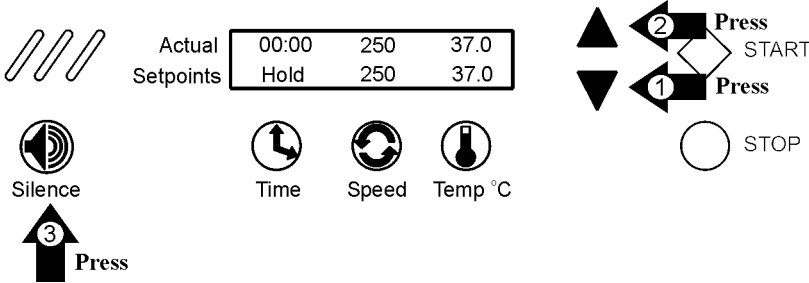

Then press the Speed button beneath RPM.

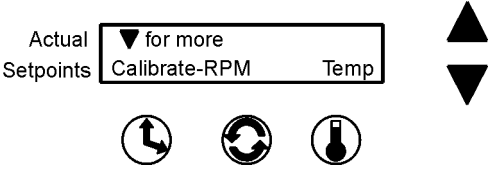

The value shown on this screen is the present Speed setpoint. Using the up and down arrows, increase or decrease the platform speed until the reading on an independent, accurate speed measuring device matches the shaker speed setpoint.

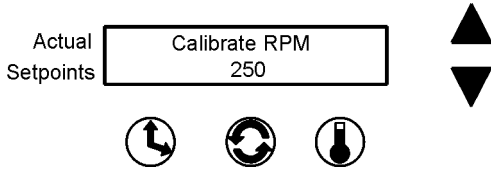

When finished, press any of the three buttons (Time, Speed, or Temp) to save the new setpoint value and return to the previous screen, or press nothing for about 15 seconds to save the new setpoint value and return to the Operating Screen.

Alarm Message	Alarm Criteria	Alarm Delay*	Alarm Ringback*	System State	Corrective Action
Over Temp Shutdown	Temperature at the over temp sensor is a few tenths of a degree over the shut down set point	None	15 min.	Alarm light on Audible alarm on Blower fans on Shaker motor on Heaters off	Press the Silence button to mute audible alarm Air intake blockage Over temperature probe malfunction Sensor connector unplugged Heater circuit not cycling Main circuit board failure Call the Technical Services Department
Under Temp Shutdown	Temperature at the over temp sensor is a few tenths of a degree under the shut down set point	None	15 min.	Alarm light on Audible alarm on Blower fans on Shaker motor on Refrig compressor off (493/495 only)	Press the Silence button to mute audible alarm Over temperature probe malfunction Sensor connector unplugged Heater circuit not cycling Refrigeration system stuck on Main circuit board failure Call the Technical Services Department
Main Temp Sensor	Sensor circuit is open or shorted beyond the expected resistance range in either direction	30 sec.	15 min.	Alarm light on Audible alarm on Blower fans on Shaker motor on Heaters off	Press the Silence button to mute audible alarm Check board connector Check sensor circuit Replace sensor Call the Technical Services Department
Over Temp Sensor	Sensor circuit is open or shorted beyond the expected resistance range in either direction.	30 sec.	15 min.	Alarm light on Audible alarm on Blower fans on Shaker motor on Heaters on	Press the Silence button to mute audible alarm Check board connector Check sensor circuit Replace sensor Call the Technical Services Department
Temperature is High	Temperature is above the control system's temperature tracking limit	**	15 min.	Alarm light on Audible alarm on Blower fans on Shaker motor on Heaters on	Press the Silence button to mute audible alarm Check temperature tracking limit Check sensor circuit Replace main temperature sensor Call the Technical Services Department

* Alarm Delay and Ringback times are approximate

** A 3.5 hour time delay is built into the system to allow the shaker to reach the temperature setpoint. When this point is reached, a 20 minute delay becomes effective. When the lid is opened, a 15 minute interval is added to allow the system to recover to the set temperature. (Note: all of these times are approximate)

Alarm Message	Alarm Criteria	Alarm Delay*	Alarm Ringback*	System State	Corrective Action
Temperature is Low	Temperature is below the control system's temperature tracking limit	**	15 min.	Alarm light on Audible alarm on Blower fans on Shaker motor on Heaters on	Press the Silence button to mute audible alarm Check if lid is completely closed Check temperature tracking limit Check sensor circuit Replace main temperature sensor Call the Technical Services Department
Power Failure	Mains - Unit power has been off for more than 1½ hours or electrical power has been disrupted during operation for more than 15 seconds. - Transformer Auto Reset thermostat reaches its trip temp	30 sec after power up	None	Alarm light on Audible alarm on Fans, motor, heaters, refrigeration same as before power interruption.	Warning notice only Press the Silence button to mute audible alarm and extinguish visible alarm - Room ambient too high or overload condition exists. Lower ambient & have cabinet evaluated by qualified service technician.
Cycle Complete	Count-down time has reached zero	None	None	Alarm light on Audible alarm on Blower fans on Shaker motor off Heaters, refrigeration per Hold temp setpoint	Advisory notice only Press the Silence button to mute audible alarm and extinguish visible alarm
RPM is High	Speed is above control set point by 5 RPM tracking limit	2 min.	15 min.	Alarm light on Audible alarm on Blower fans on Shaker motor on Heaters on	Press the Silence button to mute audible alarm Check platform loading Shut the unit off and call the Technical Services Department
RPM is Low	Speed is below control setpoint by 5 RPM tracking limit	2 min.	15 min.	Alarm light on Audible alarm on Blower fans on Shaker motor on Heaters on	Press the Silence button to mute audible alarm Check for overloaded platform Check for obstruction to edges of platform Shut the unit off and call the Technical Services Department

* Alarm Delay and Ringback times are approximate

** A 3.5 hour time delay is built into the system to allow the shaker to reach the temperature setpoint. When this point is reached, a 20 minute delay becomes effective. When the lid is opened, a 15 minute interval is added to allow the system to recover to the set temperature. (Note: all of these times are approximate)

Alarm Message	Alarm Criteria	Alarm Delay*	Alarm Ringback*	System State	Corrective Action
Check Belt	Rotation sensor circuit sees no mechanical rotation or receives unusual signals	None	30 min.	Alarm light on Audible alarm on Blower fans on Shaker motor off Heaters off	Press the Silence button to mute audible alarm Shut the unit off and check the belt If the alarm persists, call the Technical Services Department
Audible is Disabled!	Operator has turned off the audible alarm	None	None	Normal operation	The lower half of the display will show this warning as long as the audible alarm remains turned off
Platform Stalled	Motor tries to start but platform is obstructed.	15 sec.	15 min.	Alarm light on Audible alarm on Blower fans on Shaker motor on/off/on Heaters off	Press the Silence button to mute audible alarm Check for overloaded platform Check for platform edge obstructions Turn unit off and call the Technical Services Department
Check Fuse	Power disconnected from motor drive circuit board	30 sec.	30 min.	Alarm light on Audible alarm on Blower fans on Shaker motor off Heaters off	Press the Silence button to mute audible alarm Shut unit off and check the motor drive fuse If alarm persists, call the Technical Services Department

* Alarm Delay and Ringback times are approximate

Section 5 Specifications

Shaking

Range 25-400 RPM
Accuracy 1 RPM
Motion One inch/orbital
Indicator LCD in 1 RPM increments

Temperature

Range:
SHKE8000 & SHKE8000-1CE
. 10°C (50°F) above ambient to 60°C (140°F)
SHKE8000-7 & SHKE8000-8CE
. 5°C (41°F) or 20°C below ambient, to 60°C (140°F)
Control ±0.15°C
Uniformity ±0.3°C (in flask)
Indicator LCD in 0.1°C increments

Timer

Range . . . Programmable from 1 minute to 199 hours 59 minutes,
or for continuous operation
Indicator LCD in 1 minute increments
Run Time . . . LCD counts down for a timed run or counts up when in
“hold” function in 1 minute decrements/increments

Alarms

Temperature Software independent overtemperature and
undertemperature shutdown circuit
Platform Speed Software independent speed control circuit
Platform Stall Software independent motor overcurrent protection
circuit
Time Cycle complete
Power Failure Loss of input power

Safety

Temperature Independent over and under temp
Speed Independent platform motion

LCD (Liquid Crystal Display)

Top line displays actual elapsed run time, speed and temperature; bottom line displays user time, speed and temperature setpoints alternating with any active alarm messages.

Mechanical Drive System

Triple counterbalanced. Compensates for unbalanced platform loads

Drive Motor

1/3 HP brushless DC, permanently lubricated ball bearing

Door

Fold-down door with pneumatic dampers and spring assisted closure.

Automatic Restart

Microprocessor retains all programming in non-volatile memory. In the event of a power outage, the shaker restarts automatically.

Construction

Cabinet

Interior Stainless steel with coved corners

Exterior Cold rolled steel

Finish . . . Powder coated for a durable, easily maintained surface

Platform Anodized brushed aluminum

Door

Powder coated stainless steel

Tempered thermal pane window (Heated window - refrigerated units)

Dimensions

Exterior - SHKE8000 46.5”W x 25.0”H x 33.3”F-B
. (118.1cm x 63.5cm x 84.6cm)

Exterior - SHKE8000-7JPN . . 56.5”W x 25.0”H x 33.3”F-B
. (143.5cm x 63.5cm x 84.6cm)

Exterior - door open 46.6” (118.4cm) F-B

Interior 33.4” W x 11.8” H x 23.8” F-B
. (84.8cm x 30.0cm x 60.5cm)

Electrical

SHKE8000

Nominal 120VAC, 60Hz, 1 PH, 6.4 FLA

SHKE8000-1CE

Nominal 230VAC, 50Hz, 1 PH, 3.0 FLA

SHKE8000-7

Nominal 120VAC, 60Hz, 1 PH, 9.0 FLA

SHKE8000-8CE

Nominal 230VAC, 50Hz, 1 PH, 4.5 FLA

Data Output RS-232 standard

Remote Alarm Contacts

Certifications

Declaration of Conformity available upon request.

Capacity

Flasks From (91) 25ml up to (6) 2.8L

Weights

Net

SHKE8000 & SHKE8000-1CE545 lbs. (247.2kg)

SHKE8000-7 & SHKE8000-8CE . . 610 lbs. (276.7kg)

Shipping

SHKE8000 & SHKE8000-1CE 658 lbs. (298.5kg)

SHKE8000-7 & SHKE8000-8CE . . .723 lbs. (328.0kg)

Maximum Product Weight (equally distributed) Per Platform *

71 lbs (32.2kg)

Optional Platforms

Size 30" x 18" (76.2cm x 45.7cm)

Clips . . .25ml, 50ml, 125ml, 250/300ml, 500ml, 1L, 2L, 2.8L

Racks . . Adjustable angle test tube holder with rack, 10-30mm

Chamber Air Filter

Rated 95% efficient at 0.3 microns

11.0" x 20.0" x 1.5" (27.9cm x 50.8cm x 3.8cm)

Ambient Operating Conditions

Indoor use only

Temperature 5°C (41°F) to 32°C (89.6°F)

Humidity 80% RH at or below 31°C, decreasing linearly to 50% RH at 32°C

Sound Level Not to exceed 64db

Caution Running Maximum Product Weight and Maximum RPM may not be possible. ▲

Intended Use

Orbital shakers are designed to provide increased aeration in a stable environment

Unintended Use

- 1) Not intended for use in Class I or II applications as defined in 21 CFR
- 2) Not intended for mixtures of flammable materials

Safety Specifications

Indoor Use Only

Altitude 2,000 meters

Temperature 5°C to 32°C

Humidity 80% RH at or below 32°C,
decreasing linearly to 50% RH at 32°C

Mains Supply Fluctuations ±10%

Installation Category II ¹

Pollution Degree 2 ²

Class of Equipment I

Climatic Condition - ST (EN 60335, Subtropical)

Fluorinated Greenhouse Gases

Compliant with REGULATION (EU) No 517/2014 OF THE EUROPEAN PARLIAMENT AND OF THE COUNCIL on fluorinated greenhouse gases.

This product contains fluorinated greenhouse gases in a hermetically sealed system. This product contains foam blown with fluorinated greenhouse gas, R-245fa. If a leak in the sealed system is detected, the operator shall repair without undue delay.

The following model is designed with the following amounts of fluorinated greenhouse gases:

Model	Refrigerant	Amount (kg)	GWP
SHKE8000-8CE	R-134a	0.298	1430

1 Installation category (overvoltage category) defines the level of transient overvoltage which the instrument is designed to withstand safely. It depends on the nature of the electricity supply and its overvoltage protection means. For example, in CAT II which is the category used for instruments in installations supplied from a supply comparable to public mains such as hospital and research laboratories and most industrial laboratories, the expected transient overvoltage is 2500V for a 230V supply and 1500V for a 120V supply.

2 Pollution Degree describes the amount of conductive pollution present in the operating environment. Pollution Degree 2 assumes that normally only non-conductive pollution such as dust occurs with the exception of occasional conductivity caused by condensation.

Section 6 Parts List

Common Parts to All Models

Part No.	Description
191535	Board, Motor Drive
192589	Replacement Control Board
190525	Board, Triple Output Relay
142050	LED Interior Lamp
129051	Damper Pneumatic, Door
900138	Fan, 123 CFM Internal Circulation 24VDC
900139	Fan, 18 CFM Component 24VDC
270179	Filter, EMI Power
760440	Filter HEPA
990046	Gasket Door
138013	Heater, 600W, 100 VAC
156089	Motor, 24VDC Brushless
191734	Kit, Display/Keypad Replacement
400161	Power Supply, 24VDC Output
290181	Sensor, Temperature 2252 Ohm @ 25C
194046	Spare Parts Bag (platform and clips)
285306	Switch, Door
360237	Switch, Light
400113	Thermostat, Heater
420130	Transformer, 1KVA
420064	Transformer, 130VA
420085	Transformer, 25VA
800040	V-Belt
443021	Wrench, 3/4" Open End
443020	Wrench, 5/32" Hex T-Handle
129052	Spring, Door
194024	Spare Parts Bag (Test Tube Holder)
194254	Platform Assembly Latch Handle

Specific Parts for Model SHKE8000 and SHKE8000-ICE

Part No.	Description
107005	Window, Door Glass

Specific Parts for Model SHKE8000

Part No.	Description
230178	Circuit Breaker/Switch, 8A
230144	Fuse, 5 x 20mm, 0.25A
230145	Fuse, 5 x 20mm, 1.6A
300275	Relay, 20A

Specific Parts for Model SHKE8000-ICE

Part No.	Description
230186	Circuit Breaker/Switch, 5A
230142	Fuse, 5 x 20mm, 0.150A
230141	Fuse, 5 x 20mm, 0.8A
300276	Relay, 20A

Specific Parts for Model SHKE8000-7 and SHKE8000-8CE

Part No.	Description
760202	Filter, Condenser Air
204012	Condenser
220630	Constant Pressure Valve
209007	Dryer
204013	Evaporator
107006	Window, Door Glass

Specific Parts for Model SHKE8000-7

Part No.	Description
230179	Circuit Breaker/Switch, 10A
900105	Fan, 235 CFm Condenser 120VAC
230144	Fuse, 5 x 20mm, 0.25A
230145	Fuse, 5 x 20mm, 1.6A
203033	Compressor
300275	Relay, 20A

Specific Parts for Model SHKE8000-8CE

Part No.	Description
230178	Circuit Breaker/Switch, 8A
900107	Fan, 235 CFm Condenser 230VAC
230142	Fuse, 5 x 20mm, 0.15A
230141	Fuse, 5 x 20mm, 0.8A
203034	Compressor
300276	Relay, 20A

DRAWING NUMBER: 493-90-1-B

REV	ECN NO.	DATE	BY	CAD APPD	DESCRIPTION OF REVISION	
0	DS-429	12-06-11	MSB	KDG	CCS	RELEASED FOR PRODUCTION/MAS DWG: 490

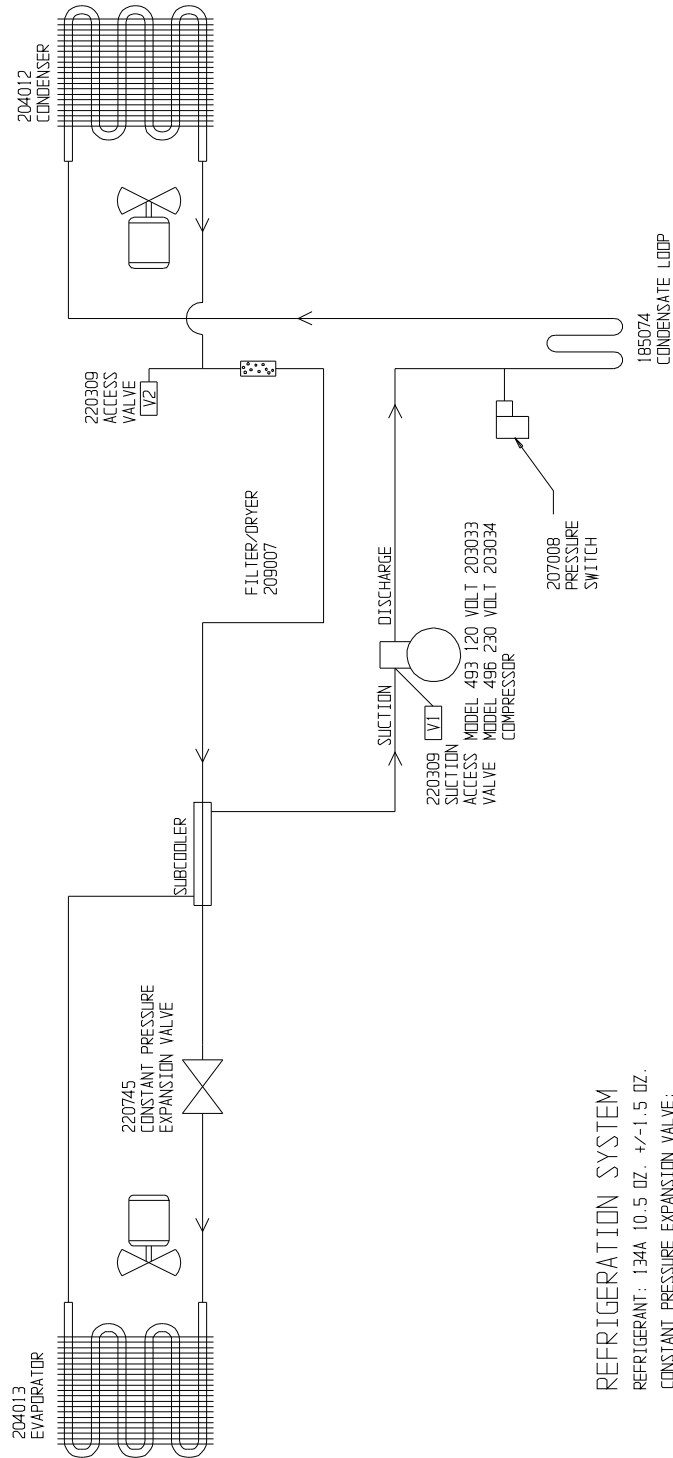

REFRIGERATION SYSTEM

REFRIGERANT: 134A 10.5 OZ. +/- 1.5 OZ.
 CONSTANT PRESSURE EXPANSION VALVE:
 SET AT 23.5 PSIG +/- 2 PSIG MEASURED AT V1.

THIS DOCUMENT CONTAINS PROPRIETARY INFORMATION AND SUCH INFORMATION IS NOT TO BE DISCLOSED TO OTHERS FOR ANY PURPOSE NOR USED FOR MANUFACTURING PURPOSES WITHOUT WRITTEN PERMISSION FROM THERMO FISHER SCIENTIFIC		MODEL/PART NAME: 493,496 REFRIGERATED STACKED SHAKERS	
DRAWING TITLE: REFRIGERATION SCHEMATIC		DATE: 12-06-11 SCALE: NONE	
DRAWN: KDG		APPD: DRP	
MATERIAL:			
PAINT COLOR:			
TOLERANCE UNLESS OTHERWISE SPECIFIED		DRAWING NUMBER	
ANGLES: DECIMAL: .XXX±		493-90-1	
		SIZE	
		B	

1. COMMON TO: 493 & 496

POWER CONNECTION
120 VAC, 1 PH, 60Hz, 6.0 AMPS

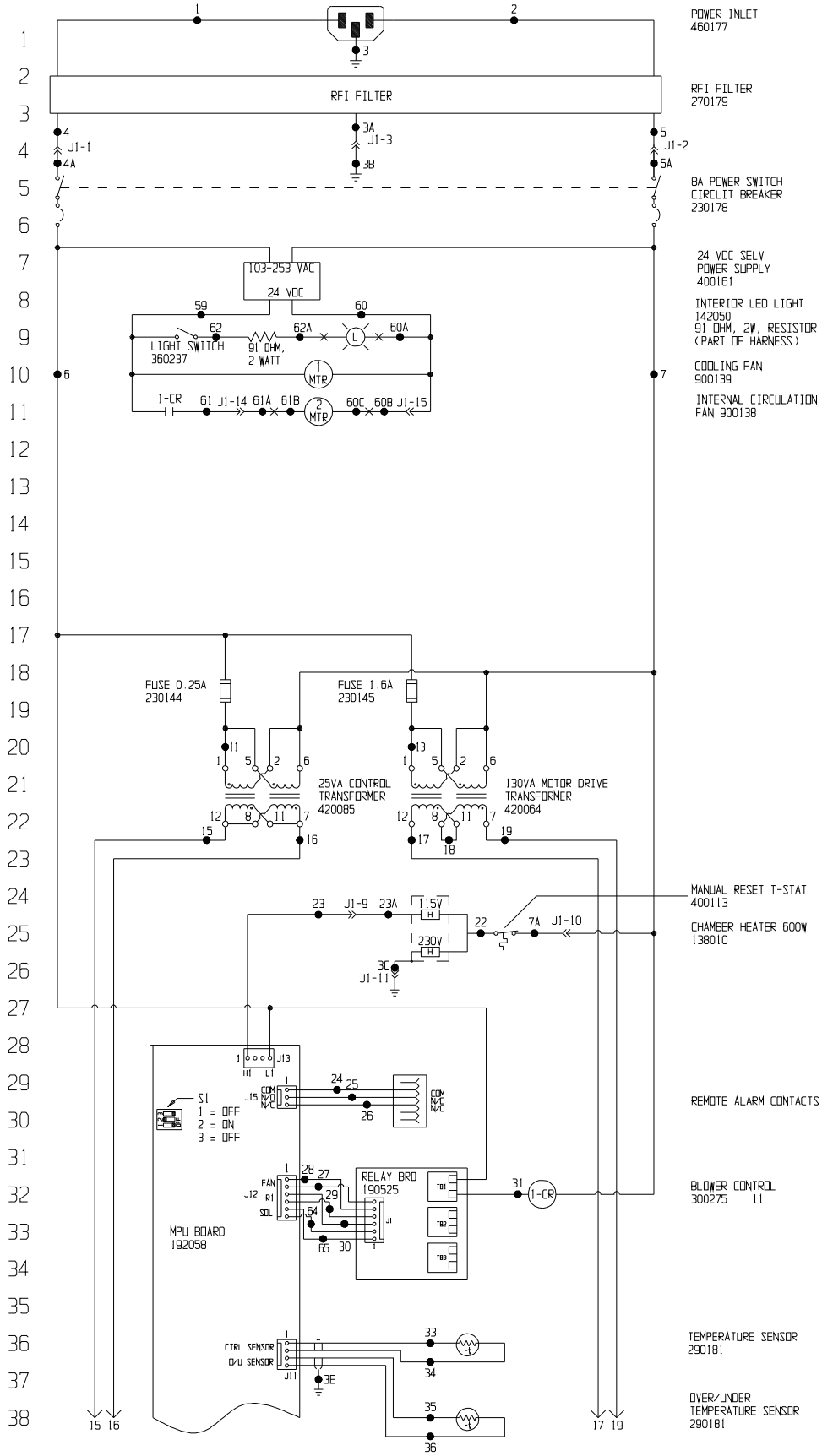

Electrical Schematic
Model:
443
Incubator
Stacked Shaker

443-70-1-D REV. 2
Page 1 of 3

39
40
41
42
43
44
45
46
47
48
49
50
51
52
53
54
55
56
57
58
59
60
61
62
63
64
65
66
67
68
69
70
71
72
73
74
75
76

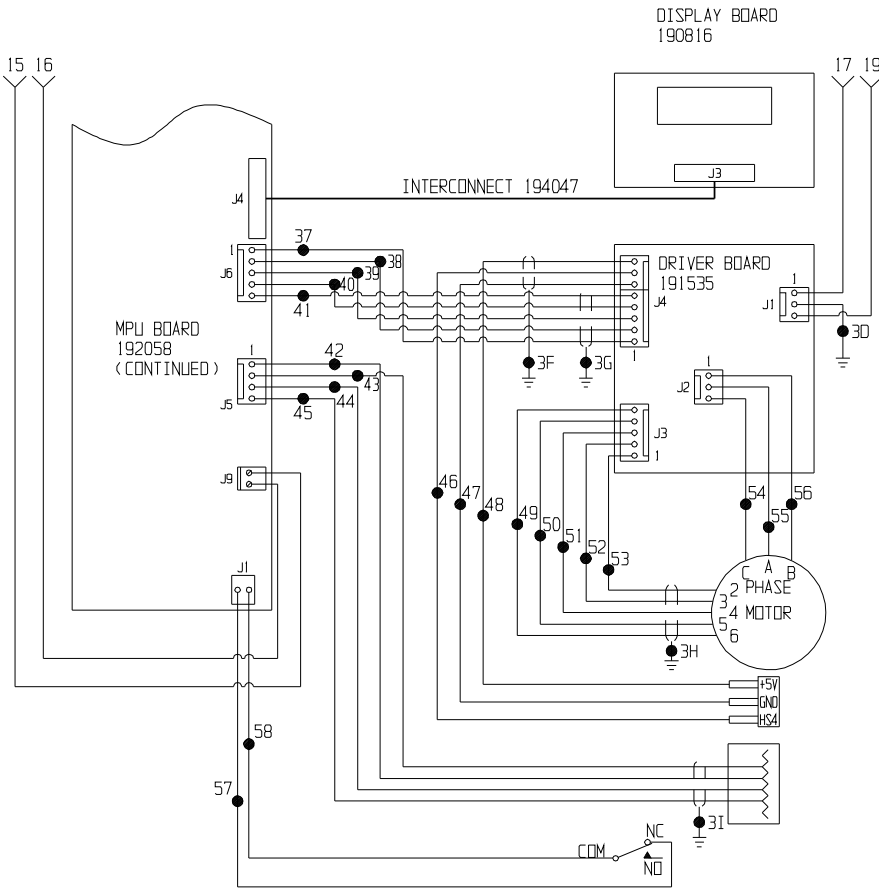

MOTOR
156089

BELT SENSOR
290144

RS-232	RS-485	PIN
RX DATA	-XEV	2
GND	+XEV	3
TX DATA		4
GND		5

DOOR SWITCH
(SHOWN DOOR OPEN)
285306

Electrical Schematic
Model:
443
Incubator
Stacked Shaker

443-70-1-D REV. 2
Page 2 of 3

77
78
79
80
81
82
83
84
85
86
87
88
89
90
91
92
93
94
95
96
97
98
99
100
101
102
103
104
105
106
107

WIRE REFERENCE CHART

WIRE #	GAUGE	COLOR	WIRE #	GAUGE	COLOR
1	18	BROWN	28	24	BLACK
2	18	BLUE	29	24	BLACK
3-3B	18	GRN/YEL	30	24	BLACK
3C-3D	18	GRN/YEL	31	18	YELLOW
3E-3I		SHIELDS			
4-4A	18	BROWN	33	24	RED
			34	24	GREEN
5-5A	18	WHITE	35	24	WHITE
			36	24	BLACK
			37	24	BLACK
6	18	BLACK	38	24	RED
7-7A	18	WHITE	39	24	GREEN
			40	24	WHITE
			41	24	BROWN
			42	24	BLACK
			43	24	RED
			44	24	GREEN
			45	24	WHITE
			46	24	GREEN
			47	24	BLACK
11	18	RED	48	24	RED
			49	24	BLACK
13	18	YELLOW	50	24	RED
15	18	BROWN	51	24	GREEN
16	18	BLUE	52	24	WHITE
17	18	RED	53	24	BROWN
18	18	ORANGE	54	18	RED
19	18	RED	55	18	WHITE
22	18	YELLOW	56	18	BLACK
23-23A	18	BROWN	57	22	GREEN
			58	22	WHITE
24	24	GREEN	59	18	RED
25	24	RED	60-60C	18/22	BLACK
26	24	BLACK	61-61B	18/22	RED
27	24	BLACK	62-62A	18/22	RED
			64	24	BLACK
			65	24	BLACK

2	DS-751	03-13-14	GLS	GLS	CCS	CHG MICRO BD FROM 191688, EMC CHG	
1	DS-683	11-27-13	GLS	GLS	DRP	CHG FROM HALOGEN TO LED LIGHT	
0	DS-429	12-06-11	MSB	KDG	DRP	RELEASED FOR PRODUCTION WAS 440 DWG.	
REV	EN	NO	DATE	BY	CAD	APPD	DESCRIPTION OF REVISION

MODEL/PART NAME: 443 INCUBATOR STACKED SHAKER
 DWG TITLE: ELECTRICAL SCHEMATIC
 DWN: KDG CAD: KDG APPD: DRP DATE: 12-6-11 SCALE: NONE

MATERIAL:
 PAINT COLOR:
 TOLERANCE UNLESS OTHERWISE SPECIFIED: ANGLES: DECIMAL: .XX±
 DRAWING NUMBER: 443-70-1
 SIZE: D

Electrical Schematic
 Model:
 443
 Incubator
 Stacked Shaker

443-70-1-D REV. 2
 Page 3 of 3



THIS DOCUMENT CONTAINS PROPRIETARY INFORMATION AND SUCH INFORMATION IS NOT TO BE DISCLOSED TO OTHERS FOR ANY PURPOSE NOR USED FOR MANUFACTURING PURPOSES WITHOUT WRITTEN PERMISSION FROM THERMO FISHER SCIENTIFIC

ThermoFisher
SCIENTIFIC

BOX 649, MARIETTA, OHIO 45750

POWER CONNECTION
230 VAC, 1 PH, 50 Hz, 3 AMPS

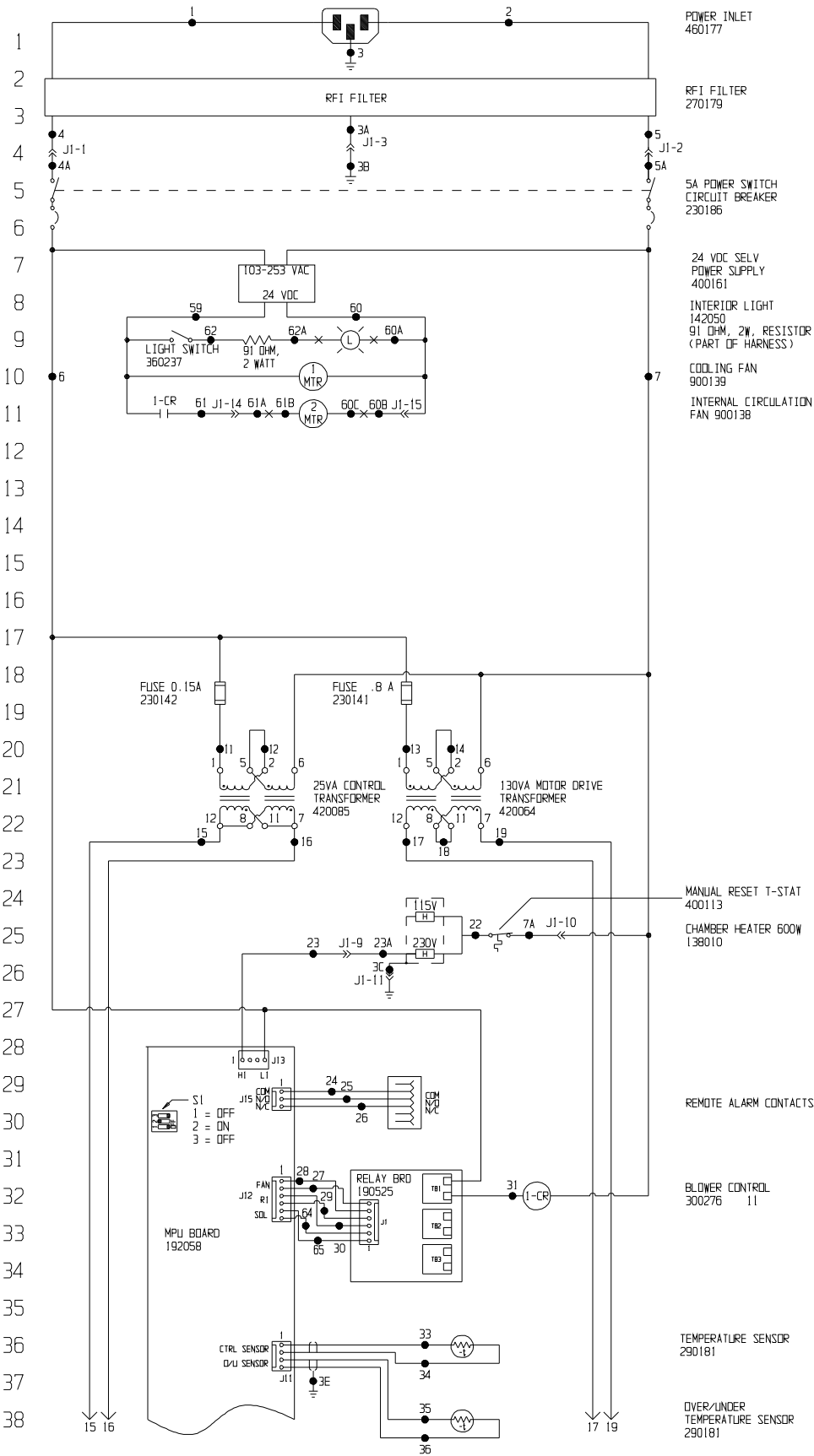

Electrical Schematic
Model:
444
Incubator Stacked
Shaker

444-70-1-D REV. 2
Page 1 of 3

39
40
41
42
43
44
45
46
47
48
49
50
51
52
53
54
55
56
57
58
59
60
61
62
63
64
65
66
67
68
69
70
71
72
73
74
75
76

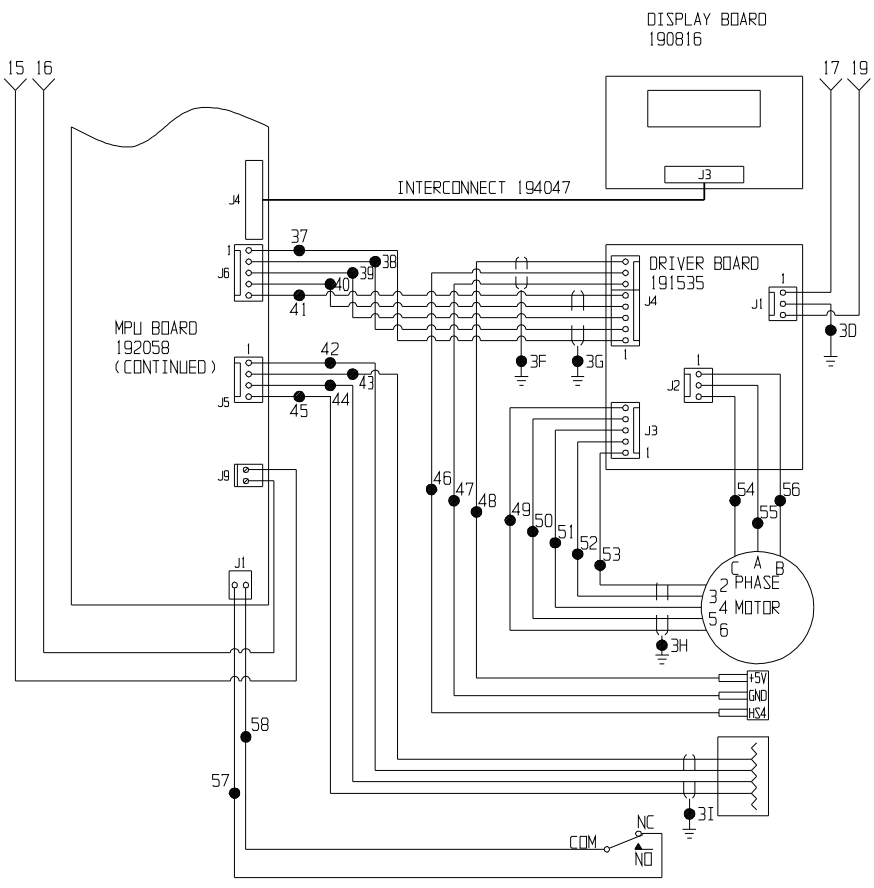

MOTOR
156089

BELT SENSOR
290144

RS-232	RS-485	PIN
RX DATA	-XCV	2
GND		3
TX DATA	+XCV	4
GND		5

DOOR SWITCH
(SHOWN DOOR OPEN)
285306

Electrical Schematic
Model:
444
Incubator Stacked
Shaker

444-70-1-D REV. 2
Page 2 of 3

77
78
79
80
81
82
83
84
85
86
87
88
89
90
91
92
93
94
95
96
97
98
99
100
101
102
103
104
105
106
107

WIRE REFERENCE CHART

WIRE #	GAUGE	COLOR	WIRE #	GAUGE	COLOR
1	18	BROWN	28	24	BLACK
2	18	BLUE	29	24	BLACK
3-3B	18	GRN/YEL	30	24	BLACK
3C-3D	18	GRN/YEL	31	18	YELLOW
3E-3I		SHIELDS			
4-4A	18	BROWN	33	24	RED
			34	24	GREEN
5-5A	18	WHITE	35	24	WHITE
			36	24	BLACK
			37	24	BLACK
6	18	BLACK	38	24	RED
7-7A	18	WHITE	39	24	GREEN
			40	24	WHITE
			41	24	BROWN
			42	24	BLACK
			43	24	RED
			44	24	GREEN
			45	24	WHITE
			46	24	GREEN
			47	24	BLACK
11	18	RED	48	24	RED
			49	24	BLACK
13	18	YELLOW	50	24	RED
15	18	BROWN	51	24	GREEN
16	18	BLUE	52	24	WHITE
17	18	RED	53	24	BROWN
18	18	ORANGE	54	18	RED
19	18	RED	55	18	WHITE
22	18	YELLOW	56	18	BLACK
23-23A	18	BROWN	57	22	GREEN
			58	22	WHITE
24	24	GREEN	59	18	RED
25	24	RED	60-60C	18/22	BLACK
26	24	BLACK	61-61B	18/22	RED
27	24	BLACK	62-62A	18/22	RED
			64	24	BLACK
			65	24	BLACK

2	DS-751	03-13-14	GLS	GLS	CCS	CHG MICRO BD FROM 191688, EMC CHG
1	DS-683	12-05-13	GLS	GLS	DRP	CHG FROM HALOGEN TO LED LIGHT
0	DS-429	12-06-11	MSB	KDG	DRP	RELEASED FOR PRODUCTION WAS 441 DWG.
REV	ECN NO.	DATE	BY	CAD	APPD	DESCRIPTION OF REVISION

Electrical Schematic
Model:
444
Incubator Stacked
Shaker



ATTENTION
OBSERVE PRECAUTIONS
ELECTROSTATIC
SENSITIVE DEVICES

THIS DOCUMENT CONTAINS PROPRIETARY INFORMATION AND SUCH INFORMATION IS NOT TO BE DISCLOSED TO OTHERS FOR ANY PURPOSE NOR USED FOR MANUFACTURING PURPOSES WITHOUT WRITTEN PERMISSION FROM THERMO FISHER SCIENTIFIC

ThermoFisher
SCIENTIFIC
BOX 649, MARIETTA, OHIO 45750

MODEL/PART NAME: 444 INCUBATOR STACKED SHAKER						
DWG TITLE: ELECTRICAL SCHEMATIC						
DWN:	KDG:	CAD:	KDG:	APPD:	DRP:	DATE: 12-6-11 SCALE: NONE
MATERIAL:						
PAINT COLOR:						
TOLERANCE UNLESS OTHERWISE SPECIFIED			DRAWING NUMBER		SIZE	
ANGLES: DECIMAL: .XX±			444-70-1		D	

444-70-1-D REV. 2
Page 3 of 3

POWER CONNECTION
120 VAC, 1 PH, 60Hz, 9.0 AMPS

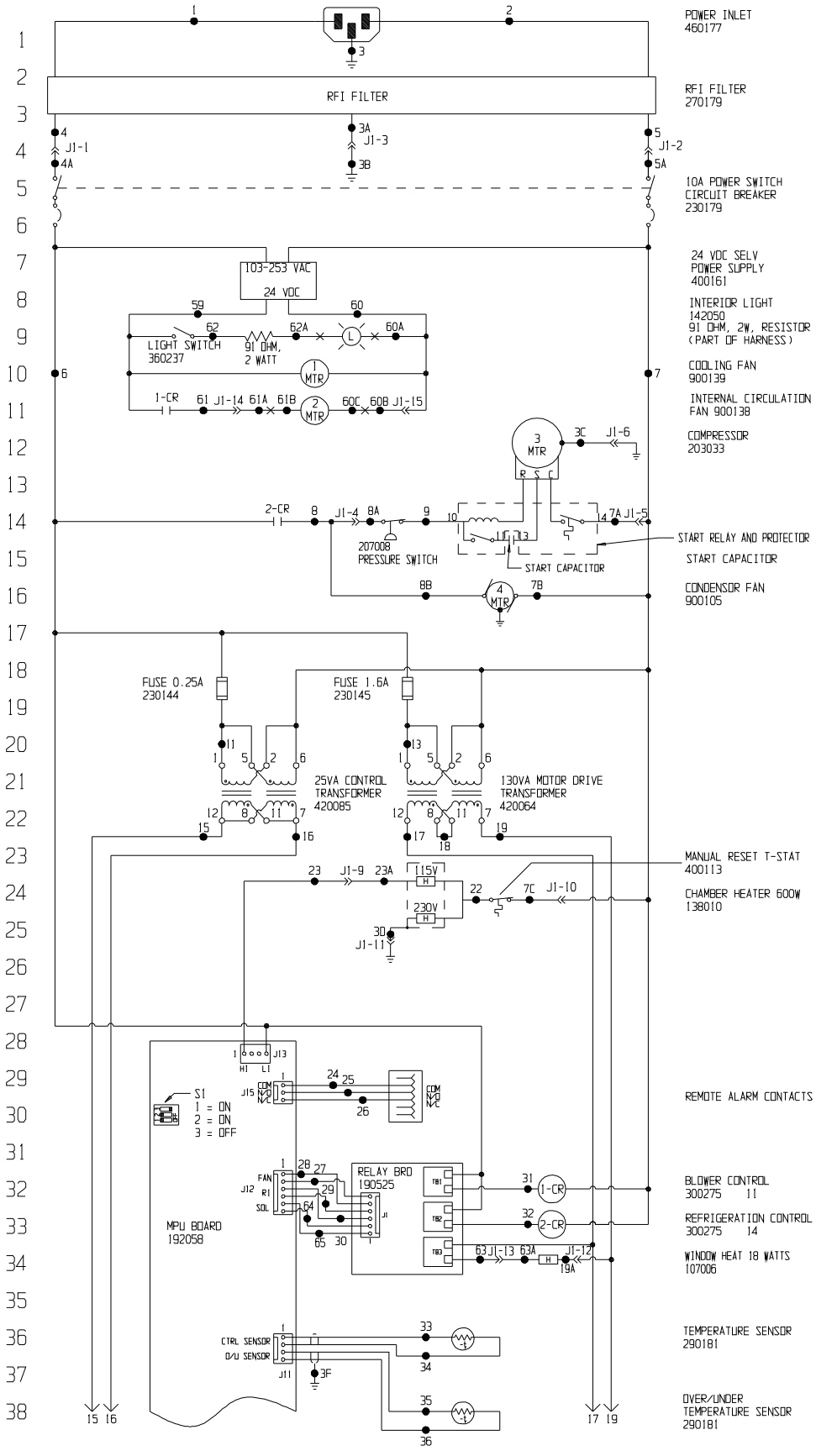

Electrical Schematic
Model:
493 MaxQ8000JPN
Refrigerated
Stacked Shaker

493-70-1-D REV. 2
Page 1 of 3

39
40
41
42
43
44
45
46
47
48
49
50
51
52
53
54
55
56
57
58
59
60
61
62
63
64
65
66
67
68
69
70
71
72
73
74
75
76

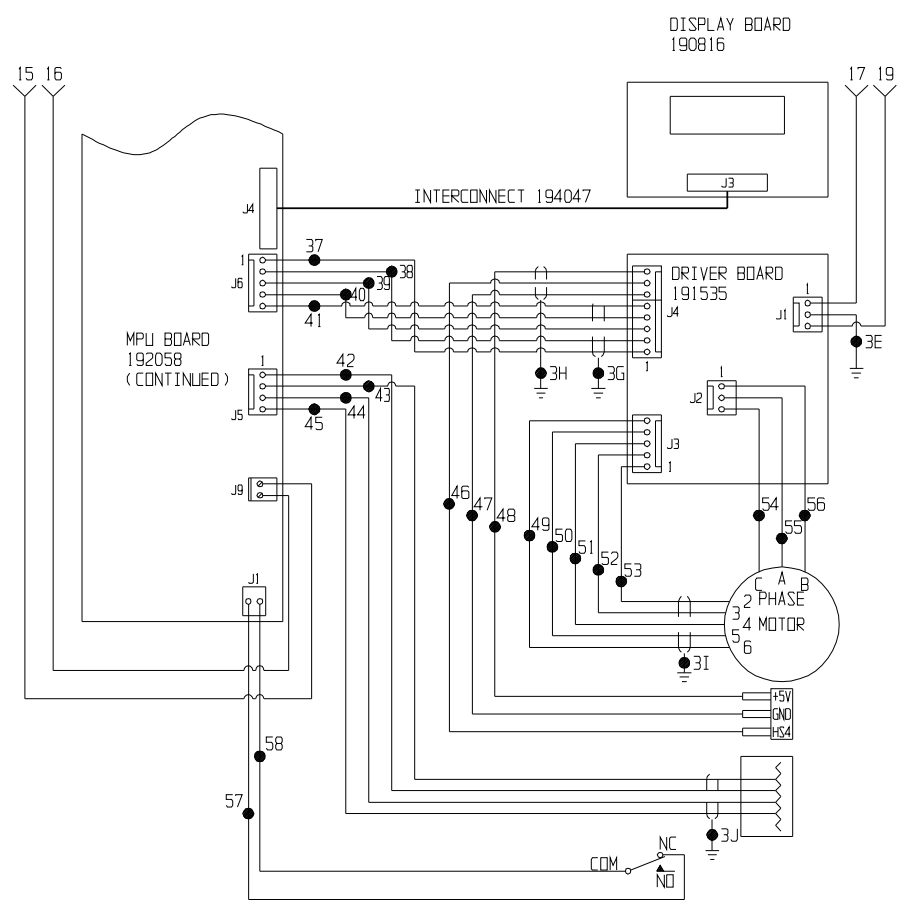

MOTOR
156089

BELT SENSOR
290144

RS-232	RS-485	PIN
RX DATA	-XCV	2
GND	+XCV	3
TX DATA		4
GND		5

DOOR SWITCH
(SHOWN DOOR OPEN)
285306

Electrical Schematic
Model:
493 MaxQ8000JPN
Refrigerated
Stacked Shaker

493-70-1-D REV. 2
Page 2 of 3

77
78
79
80
81
82
83
84
85
86
87
88
89
90
91
92
93
94
95
96
97
98
99
100
101
102
103
104
105
106
107

WIRE REFERENCE CHART

WIRE #	GAUGE	COLOR	WIRE #	GAUGE	COLOR
1	14	BROWN	28	24	BLACK
2	14	BLUE	29	24	BLACK
3-3B	14	GRN/YEL	30	24	BLACK
3C-3E	16/18	GRN/YEL	31	18	YELLOW
3F-3J		SHIELDS	32	18	BROWN
4-4A	14	BROWN	33	24	RED
			34	24	GREEN
5-5A	14	WHITE	35	24	WHITE
			36	24	BLACK
			37	24	BLACK
6	16/18	BLACK	38	24	RED
7-7A	16/18	WHITE	39	24	GREEN
7B	18	WHITE	40	24	WHITE
7C	18	WHITE	41	24	BROWN
			42	24	BLACK
			43	24	RED
8-8A	16	BROWN	44	24	GREEN
8B	18	BROWN	45	24	WHITE
9	16	BROWN	46	24	GREEN
			47	24	BLACK
			48	24	RED
			49	24	BLACK
			50	24	RED
			51	24	GREEN
			52	24	WHITE
			53	24	BROWN
			54	18	RED
			55	18	WHITE
			56	18	BLACK
			57	22	GREEN
22	18	YELLOW	58	22	WHITE
23-23A	18	BROWN	59	18	RED
24	24	GREEN	60-60C	18/22	BLACK
25	24	RED	61-61B	18/22	RED
26	24	BLACK	62-62A	18/22	RED
27	24	BLACK	63-63A	18	RED
			64	24	BLACK
			65	24	BLACK

2	DS-751	03-13-14	GLS	GLS	CCS	CHG MICRO BD FROM 191688, EMC CHG
1	DS-683	12-05-13	GLS	GLS	DRP	CHG FROM HALOGEN TO LED LIGHT
0	DS-429	12-06-11	MSB	KDG	DRP	RELEASED FOR PRODUCTION WAS 490 DWG.
REV	ECN NO.	DATE	BY	CAD	APPD	DESCRIPTION OF REVISION

Electrical Schematic
Model:
493 MaxQ8000JPN
Refrigerated
Stacked Shaker

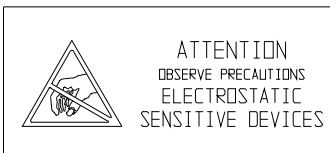

THIS DOCUMENT CONTAINS PROPRIETARY INFORMATION AND SUCH INFORMATION IS NOT TO BE DISCLOSED TO OTHERS FOR ANY PURPOSE NOR USED FOR MANUFACTURING PURPOSES WITHOUT WRITTEN PERMISSION FROM THERMO FISHER SCIENTIFIC

ThermoFisher
SCIENTIFIC
BDX 649, MARIETTA, OHIO 45750

MODEL/PART NAME: 493 REFRIGERATED STACKED SHAKER					
DWG TITLE: ELECTRICAL SCHEMATIC					
DWN: KDG	CAD: KDG	APPD: DRP	DATE: 12-6-11	SCALE: NONE	
MATERIAL:					
PAINT COLOR:					
TOLERANCE UNLESS OTHERWISE SPECIFIED			DRAWING NUMBER	SIZE	
ANGLES: DECIMAL: .XX±			493-70-1	D	

493-70-1-D REV. 2
Page 3 of 3

POWER CONNECTION
230 VAC, 1 PH, 50Hz, 4.5 AMPS

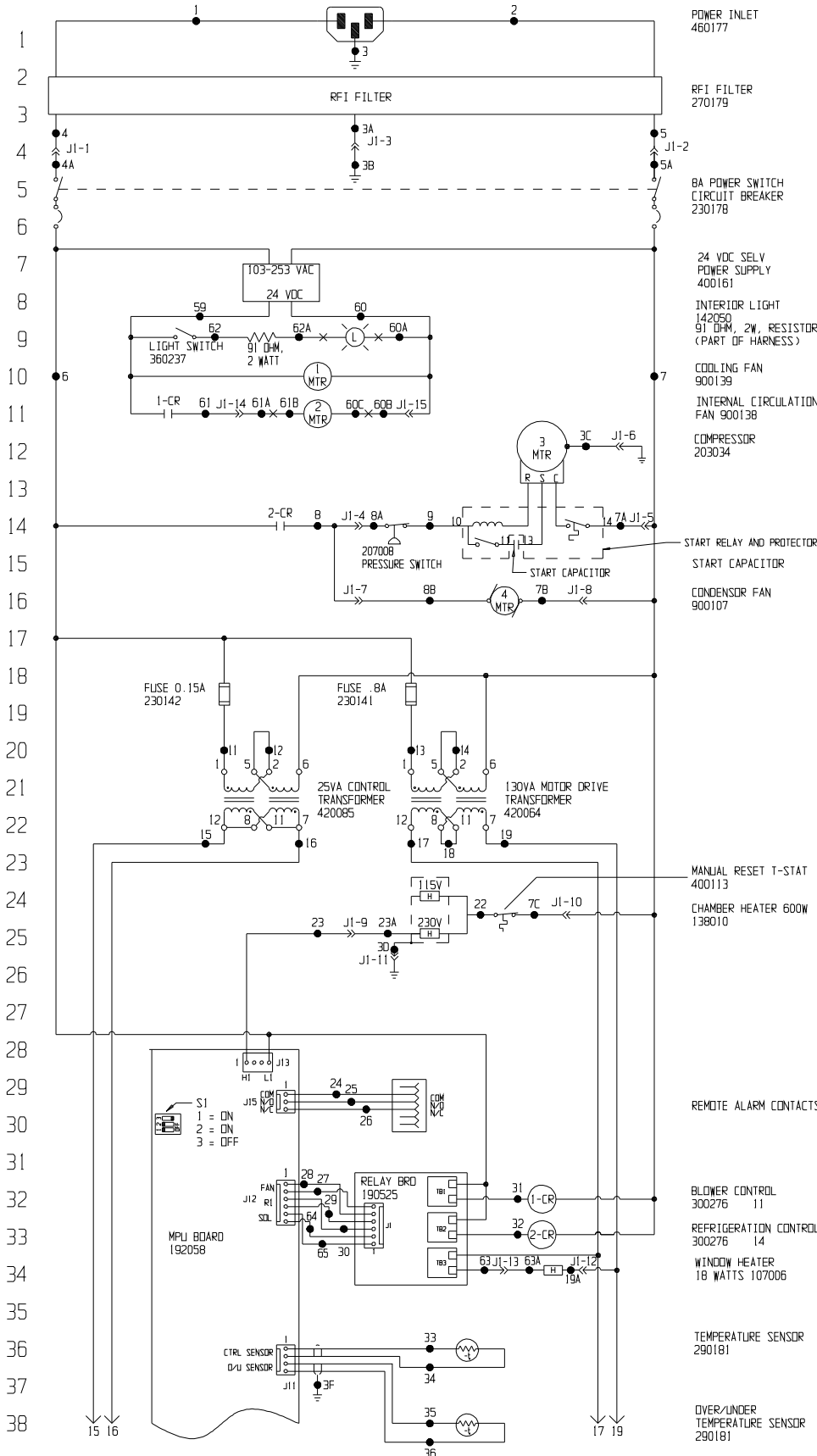

Electrical Schematic
Model:
496 MaxQ 8000-8CE
Refrigerated Stack
Shaker
496-70-1-D REV. 2
Page 1 of 3

39
40
41
42
43
44
45
46
47
48
49
50
51
52
53
54
55
56
57
58
59
60
61
62
63
64
65
66
67
68
69
70
71
72
73
74
75
76

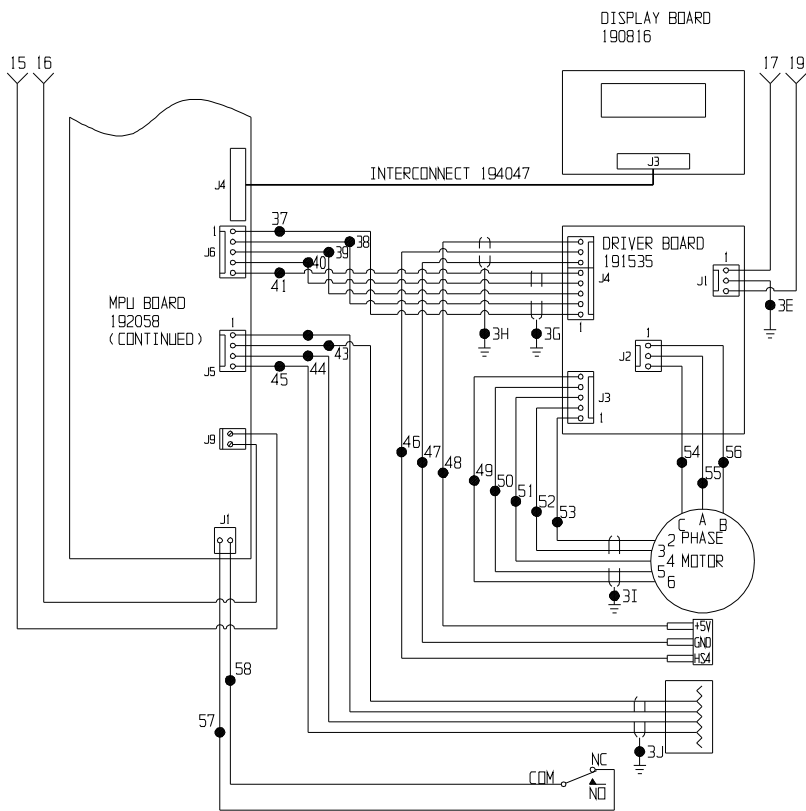

MOTOR
156089

BELT SENSOR
290144

RS-232	RS-485	PIN
RX DATA	-XCV	2
GND	+XCV	3
TX DATA		4
GND		5

DOOR SWITCH
(SHOWN DOOR OPEN)
285306

Electrical Schematic
Model:
496 MaxQ 8000-8CE
Refrigerated Stack
Shaker

496-70-1-D REV. 2
Page 2 of 3

77
78
79
80
81
82
83
84
85
86
87
88
89
90
91
92
93
94
95
96
97
98
99
100
101
102
103
104
105
106
107

WIRE REFERENCE CHART

WIRE #	GAUGE	COLOR	WIRE #	GAUGE	COLOR
1	14	BROWN	28	24	BLACK
2	14	BLUE	29	24	BLACK
3-3B	14	GRN/YEL	30	24	BLACK
3C-3E	16/18	GRN/YEL	31	18	YELLOW
3F-3J		SHIELDS	32	18	BROWN
4-4A	14	BROWN	33	24	RED
			34	24	GREEN
5-5A	14	WHITE	35	24	WHITE
			36	24	BLACK
			37	24	BLACK
6	16/18	BLACK	38	24	RED
7-7A	16/18	WHITE	39	24	GREEN
7B	18	WHITE	40	24	WHITE
7C	18	WHITE	41	24	BROWN
			42	24	BLACK
			43	24	RED
8-8A	16	BROWN	44	24	GREEN
8B	18	BROWN	45	24	WHITE
9	16	BROWN	46	24	GREEN
11	18	RED	47	24	BLACK
12	18	BROWN	48	24	RED
13	18	YELLOW	49	24	BLACK
14	18	BROWN	50	24	RED
15	18	BROWN	51	24	GREEN
16	18	BLUE	52	24	WHITE
17	18	RED	53	24	BROWN
18	18	ORANGE	54	18	RED
19-19A	18	RED	55	18	WHITE
			56	18	BLACK
			57	22	GREEN
22	18	YELLOW	58	22	WHITE
23-23A	18	BROWN	59	18	RED
24	24	GREEN	60-60C	18/22	BLACK
25	24	RED	61-61B	18/22	RED
26	24	BLACK	62-62A	18/22	RED
27	24	BLACK	63-63A	18	RED
			64	24	BLACK
			65	24	BLACK

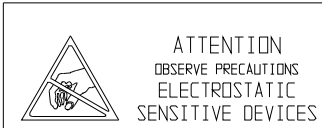

ATTENTION
OBSERVE PRECAUTIONS
ELECTROSTATIC
SENSITIVE DEVICES

THIS DOCUMENT CONTAINS PROPRIETARY INFORMATION AND SUCH INFORMATION IS NOT TO BE DISCLOSED TO OTHERS FOR ANY PURPOSE NOR USED FOR MANUFACTURING PURPOSES WITHOUT WRITTEN PERMISSION FROM THERMO FISHER SCIENTIFIC



BDX 649, MARIETTA, OHIO 45750

2	DS-751	03-13-14	GLS	GLS	CCS	CHG MICRO BD FROM 191688, EMC CHG
1	DS-683	12-05-13	GLS	GLS	DRP	CHG FROM HALOGEN TO LED LIGHT
0	DS-429	12-06-11	MSB	KDG	DRP	RELEASED FOR PRODUCTION/WAS 491 DWG.
REV	ECN NO.	DATE	BY	CAD	APPD	DESCRIPTION OF REVISION

MODEL/PART NAME: 496 REFRIGERATED STACKED SHAKER
DWG TITLE: ELECTRICAL SCHEMATIC
DWN: KDG CAD: KDG APPD: DRP DATE: 12-6-11 SCALE: NONE

MATERIAL:		DRAWING NUMBER		SIZE
PAINT COLOR:		496-70-1		D
TOLERANCE UNLESS OTHERWISE SPECIFIED				
ANGLES: DECIMAL: .XX±				
DECIMAL: .XXX±				

Electrical Schematic
Model:
496 MaxQ 8000-8CE
Refrigerated Stack
Shaker

496-70-1-D REV. 2
Page 3 of 3

THERMO FISHER SCIENTIFIC DIGITAL SHAKER WARRANTY USA

The Warranty Period starts two weeks from the date your equipment is shipped from our facility. This allows shipping time so the warranty will go into effect at approximately the same time your equipment is delivered. The warranty protection extends to any subsequent owner during the warranty period.

During the first 24 months, component parts proven to be non-conforming in materials or workmanship will be repaired or replaced at Thermo's expense, labor included. For an additional 3 years, component parts proven to be non-conforming in materials or workmanship will be repaired or replaced at Thermo's expense, labor excluded. In addition, the Orbital Shaker mechanism is warranted for 10 years, parts only, F.O.B. factory. The mechanism is defined as the bearing assemblies. The warranty will be void if the equipment is altered without written authorization from Thermo. Installation and calibration is not covered by this warranty agreement. The Technical Services Department must be contacted for warranty determination and direction prior to performance of any repairs. Expendable items, i.e., glass, filters, light bulbs and lid gaskets are excluded from this warranty. Extended warranties are dependent on the units being maintained regularly as stated in the operation and service manuals.

Replacement or repair of components parts or equipment under this warranty shall not exceed the warranty to either the equipment or to the component part beyond the original warranty period. The Technical Services Department must give prior approval for return of any components or equipment.

THIS WARRANTY IS EXCLUSIVE AND IN LIEU OF ALL OTHER WARRANTIES, WHETHER WRITTEN, ORAL, OR IMPLIED. NO WARRANTIES OF MERCHANTABILITY OR FITNESS FOR A PARTICULAR PURPOSE SHALL APPLY. Thermo shall not be liable for any indirect or consequential damages including, without limitation, damages relating to lost profits or loss of products.

Your local Thermo Sales Office is ready to help with comprehensive site preparation information before your equipment arrives. Printed instruction manuals carefully detail equipment installation, operation, and preventive maintenance.

If equipment service is required, please call your Technical Services Department at 1-800-438-4851 (USA and Canada) or 1-740-373-4763. We're ready to answer any questions on equipment warranty, operation, maintenance, service and special applications. Outside the USA, contact your local distributor for warranty information.



Rev. 2 6/2015

THERMO FISHER SCIENTIFIC INTERNATIONAL DIGITAL SHAKER WARRANTY

The Warranty Period starts two months from the date your equipment is shipped from our facility. This allows shipping time so the warranty will go into effect at approximately the same time your equipment is delivered. The warranty protection extends to any subsequent owner during the warranty period.

During the first 24 months, component parts proven to be non-conforming in materials or workmanship will be repaired or replaced at Thermo's expense, including labor. For an additional 3 years, component parts proven to be non-conforming in materials or workmanship will be repaired or replaced at Thermo's expense, excluding labor. In addition, the Orbital Shaker drive mechanism is warranted for 10 years, parts only, F.O.B. factory. The mechanism is defined as the bearing assemblies. The warranty will be void if the equipment is altered without the written authorization from Thermo. Installation and calibration is not covered by this warranty agreement. The local Thermo Fisher Scientific office must be contacted for warranty determination and direction prior to performance of any repairs. Expendable items, i.e., glass, filters, light bulbs and lid gaskets are excluded from this warranty. Extended warranties are dependent on the units being maintained regularly as stated in the operation and service manuals.

Replacement or repair of component parts or equipment under this warranty shall not exceed the warranty to either the equipment or to the component part beyond the original warranty period. The local Thermo Fisher Scientific office must give prior approval for return of any components or equipment.

THIS WARRANTY IS EXCLUSIVE AND IN LIEU OF ALL OTHER WARRANTIES, WHETHER WRITTEN, ORAL, OR IMPLIED. NO WARRANTIES OF MERCHANTABILITY OR FITNESS FOR A PARTICULAR PURPOSE SHALL APPLY. Thermo shall not be liable for any indirect or consequential damages including, without limitation, damages relating to lost profits or loss of products.

Thermo International Sales Office is ready to help with comprehensive site preparation information before your equipment arrives. Printed instruction manuals carefully detail equipment installation, operation, and preventative maintenance.

If equipment service is required, please call your local Thermo Fisher Scientific office. We're ready to answer your questions on equipment warranty, operation, maintenance, service and special applications.



Rev. 2 6/2015

thermoscientific.com

© 2014 Thermo Fisher Scientific Inc. All rights reserved. All trademarks are the property of Thermo Fisher Scientific and its subsidiaries. Specifications, terms and pricing are subject to change. Not all products are available in all countries. Please consult your local sales representative for details.

Thermo Fisher Scientific (Asheville) LLC

401 Millcreek Road
Marietta, Ohio 45750
United States

Thermo
S C I E N T I F I C
A Thermo Fisher Scientific Brand