

Digital Tube Rocker

88882017 & 88882018

In the United States:

For customer service, call 1-800-766-7000
To fax an order, use 1-800-926-1166
To order online: thermofisher.com

In Canada:

For customer service, call 1-800-234-7437
To fax an order, use 1-800-463-2996
To order online: thermofisher.ca

Find out more at thermofisher.com

ThermoFisher
SCIENTIFIC

Operating Manual

Revision A .04 01 2021

ThermoFisher
SCIENTIFIC

Contents

Section 1 Important Information	1
Disposing of Product	2
<hr/>	
Section 2 Introduction	2
Features	2
<hr/>	
Section 3 Inspection and Installation	3
Packing List	3
Connections	4
Structure Diagram	4
<hr/>	
Section 4 Overview	5
Specifications	5
Environmental Conditions	5
Safety Instructions	6
Loads, Angle and Speed	7
<hr/>	
Section 5 Operation	8
Control Panel	8
Installation	9
Settings	9
Installation of Accessories	10
<hr/>	
Section 6 Safety Tips and Maintenance	11
<hr/>	
Section 7 Troubleshooting	12
<hr/>	
Section 8 Optional Accessories	13
<hr/>	
Section 9 Warranty	14
<hr/>	
Section 10 Compliance	15
<hr/>	

Section 1 Important Information

Ignoring the following warnings could cause serious injuries or even fatal accidents.

Check the voltage, phase and capacity of power supply on the ID plate before installation. Connect properly.

Power supply must be properly grounded. Abnormal grounded connection causes serious damage. Grounded connection must not be on the water pipe and gas pipe.

Use provided power cord. Power cord: Wall outlet with grounded terminal power cord 250V 10A.

Do not install the product in a place that gas could leak. Do not use in a place that has industrial oil smoke or metallic dust. It causes fire or electric shock. Do not use the machine near to places where explosion could happen due to organic evaporating gases.

Explosive materials: acid, ester, nitro compound.

Inflammable materials: salt peroxides, inorganic peroxide, salt acids.

Check equipment for permissible environmental conditions when using inside of Temperature and Humidity Chamber or Incubator. It can be the cause of fire or trouble by stirrer electricity, electronic, and damage of motor.

Rocker's permissible environmental condition. Temperature 5°C to 40°C, Maximum relative humidity 85%.

Unplug if there is a strange sound, smell and/or smoke from the product. Stop

operating and request the service.

Keep out of the direct sunlight. It may influence product life and proper operation.

Do not use the machine at places where moisture is high and flooding can happen.

Do not assemble, repair, modify on your own, this product may not work well and electrical shock may possible.

Changes to the product could result in product inefficiency. Also this will void warranty. Which also indicates a hazardous situation, if not avoided may result in minor or moderate injury.

Do not put heavy things on the power cord. Do not put the machine on the cord. It may take off the wire coating and cause electric shock or fire.

Do not touch it with wet hands and place the main plug correctly. It could cause the electric shock or injuries.

Installing power outlet near instrument may be convenient. Allow adequate spacing around the product to ensure proper ventilation, accessibility to the power switch and for allowing the instrument to run without impediment.

Do not install the rocker near machinery generating high frequency noise. Avoid installation close to high frequency-welding machine, sewing machine, or mass SCR controller.

Do not inject any liquid and inflammable things inside of product.

Do not pour water or put liquid on the

top of the product when cleaning.

Disconnect the main power immediately and request the service if water may be in the product.

Do not let the product take any strong shock or vibration. It could cause abnormal operation or trouble. It may deteriorate the ability of the product operation and not obtain correct results.

Do not sprinkle insecticide or flammable spray on the product. Use smooth cloths. Cleaning with solvent can cause fire and deformity.

Power off while product cleaning. It may cause electric shock or fire.

Do not drop or allow the machine to fall. It will cause wrong operation and malfunction.

Only accessories that meet the manufacturer's specifications shall be used.

Disposing of Product

Dispose of the unit by separating the plastic, motor and electronics and dispose according to local laws and regulations.

Section 2 Introduction

Welcome to Thermo Scientific Digital Tube Rocker. This Digital Tube Rocker can be used in various mixing experiments, including gel colorization/ decolorization, sample cleaning, antibody staining, hybridization, immunoprecipitation, blot, and small volume tissue culture.

This product is intended to be used in a laboratory setting and is not to be used in a clinical setting.

Features

- Speed and angle are adjustable for different applications.
- It has speed/angle adjustment display function.
- It uses step-motor, with accurate speed control, stability, safe and reliable features.
- It has a power recovery function.
- Excellent heat resistance, corrosion resistance, impact resistance and chemical resistance.

Section 3 Inspection and Installation

Before unpacking the unit, first check for damages in the package of the unit.



Then unpack the unit. Check carefully to see if there were damages incurred during transit.

After unpacking, check that all unit parts and accessories are as listed below.

Contact us or the agent from which you purchased the unit if any components were omitted.

3.1 Packing List

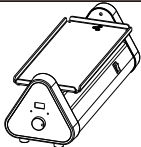
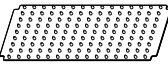
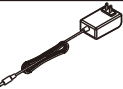
Table -1. Packing List

Description	Catalog Number		Figure
Digital Tube Rocker	88882017	88882018	
Rubber Mat (Installed)	1	1	
Power Adapter 120V	1	N/A	
Multi-Power Adapter 220V	N/A	1	

3.2 Connections

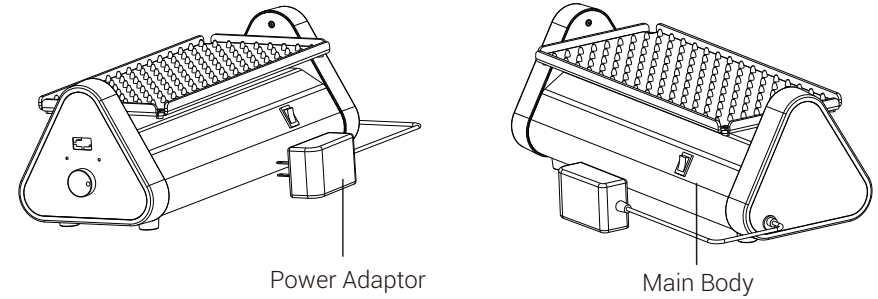

3.3 Structure Diagram

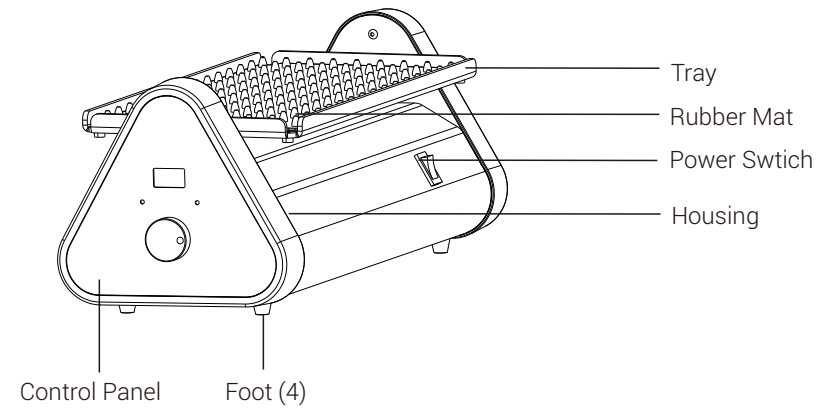

Section 4 Overview

4.1 Specifications

Rotation Speed	Speed Range.....2~40rpm Display Accuracy.....1rpm Speed Accuracy.....±1rpm
Rocking Angle	Rocking Mode.....Left right reciprocating motion Angle Range.....1°~24° Angle Accuracy.....±1°
Load	Maximum Load (Centered on tray).....16pcs (dia 10~20 mm tube)/ 7pcs (dia 22~30 mm tube)
Double Tray Load	Maximum Load (Centered on tray).....30pcs (dia 10~20 mm tube)/ 14pcs (dia 22~30 mm tube)
Size	Overall Dimensions.....411×149×146mm Tray Dimensions.....330×140×15mm Packaging Dimensions.....467×210×220mm
Weight	Net Weight.....3.4Kg(7.5lb) Gross Weight.....4.5Kg(9.9lb)
Power Supply	Input Requirement.....100-240VAC ~, 50/60Hz, 0.1A Output Requirement.....24V =, 1A
Others	Certificate.....RoHS, WEEE, cCSAus, CE Mark

4.2 Environmental Conditions

Application Environmental Conditions: indoor use
 Temperature.....5 to 40°C
 Voltage Fluctuation.....±10% of the nominal voltage
 Altitude.....≤2,000 m
 Humidity.....20% to 85%

Storage Environmental Conditions

Temperature.....0 to 60°C
 Humidity.....20% to 85%, non-condensing

4.3 Safety Instructions

Please read the entire instruction manual before operating the Digital Rocker.

WARNING DO NOT use the Digital Tube Rocker in a hazardous atmosphere or with hazardous materials for which the unit was not designed. Also, the user should be aware that the protection provided by the equipment may be impaired if accessories used are not provided or recommended by the manufacturer, or are used in a manner not specified by the manufacturer.

CAUTION ! To avoid electrical shock, completely cut off power to the unit by disconnecting the power cord from the unit or unplug from the wall outlet. Disconnect unit from the power supply prior to maintenance and service. Any spills should be removed promptly. Bio hazard spills should be cleaned using approved liquid promptly. Solvent spills are a fire hazard. Stop the unit immediately, and **DO NOT** operate until clean up is complete and vapors have dissipated.

DO NOT immerse the unit for cleaning.

DO NOT operate the unit if it shows signs of electrical or mechanical damage.

Position of Loads

Place the tube in the recommended positions below:

1. Place tube in the groove of the Rubber Mat .

Correct placement

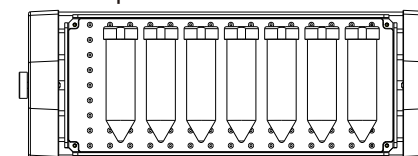

Incorrect placement

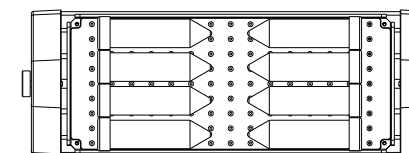

4.4 Loads, Angle and Speed

Loads of Single Tray

Tilt Angle	Tube(mm)	Maximum Speed (rpm)	Maximum Quantity (pcs)
24°	dia 10~20	40	16
1°	dia 10~20	40	16
24°	dia 22~30	40	7
1°	dia 22~30	40	7

Loads of Double Tray

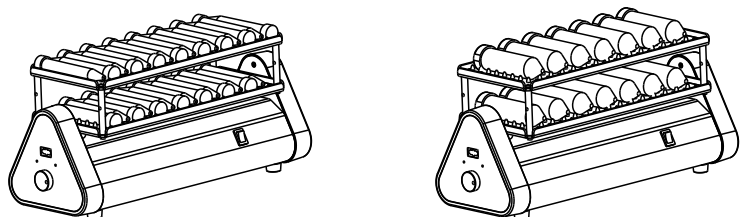

Tilt Angle	Tube(mm)	Maximum Speed (rpm)	Maximum Quantity (pcs)
20°	dia 10~20	35	30
1°	dia 10~20	35	30
20°	dia 22~30	35	14
1°	dia 22~30	35	14

Warning: It may affect the maximum speed of the instrument if placing the overweight tube.

Section 5 Operation

This chapter covers the control panel and its operation.

5.1 Control Panel

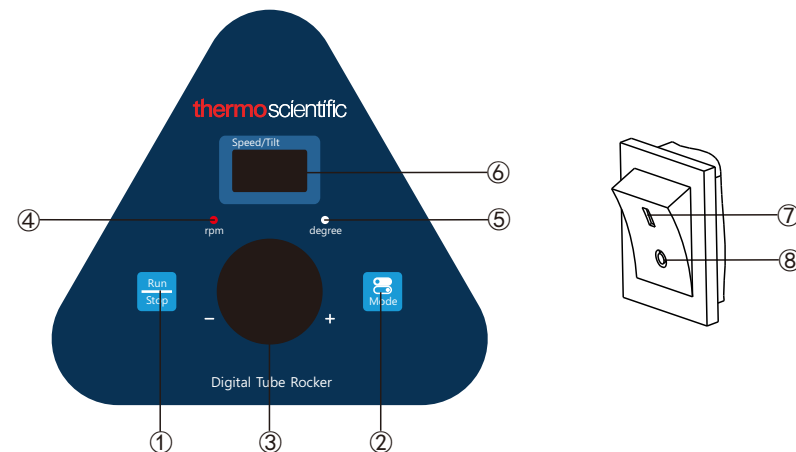

- ①. Run/Stop button: Start or stop the instrument.
- ②. Mode button: Switch modes between Speed and Tilt settings.
- ③. Rotary knob: Rotary knob is used to increase/decrease the set Speed/Tilt of the instrument.
- ④. rpm indicator: The light is on when the instrument is running in Speed Mode.
- ⑤. degree indicator: The light is on when the instrument is running in Tilt Adjustment Mode.
- ⑥. Speed/Tilt display Window: The window displays set Speed/Tilt or current speed (when the instrument is running).
- ⑦. Gear I: When the switch is in "gear I", the instrument power is on.
- ⑧. Gear O: When the switch is in "gear O", the instrument power is off.

5.2 Installation

1. Connect all the components according to the figures shown on page 4 of this manual. Use grounded power outlet. Ensure the machine is on a flat surface prior to operating.
2. Press the power switch "I" side and switch on the instrument.

5.3 Settings

Speed Settings

1. Press the "Mode" button, the "rpm" indicator light will be on.
2. Press the rotary knob, the number shown on the Speed/Tilt display window starts flashing, turn rotary knob to increase or decrease the speed value.
3. When the speed shown on Speed/Tilt display window reaches the set value, press the knob again within 5s to save the value, and the display window will stop flashing. The speed setting is completed.

Tilt Angle Setting

1. Press "Mode" button and the "degree" indicator light will be on.
2. Press the rotary knob, the number shown on the Speed/Tilt display window starts flashing, turn rotary knob to increase or decrease the Tilt value. The range of the tilt displayed on the window is 1° to 24°.

3. When the angle shown on the Speed/Tilt display window reaches the set value, press the rotary knob again within 5s to save the value, and the display window will stop flashing. The tilt angle setting is completed.

Run and Stop

Press "Run/Stop" button and the instrument will start running.

Press "Run/Stop" button again and the instrument will slow down until it stops. The instrument will then be in standby and the display window will show the set values.

Finish Operation

After the operation is finished, press the power switch at the back right side the instrument and put it into the "O" state. Unplug the instrument and store the instrument according to the storage guide.

Alarm System

E1: If running speed does not match the setting speed for 3mins, there will be a buzzer, and then E1 will be displayed on the Speed display window.

When the instrument alarms, press any key and the instrument goes into standby mode.

Power Recovery

If the power supply is cut off suddenly while the instrument is in operation, the unit will automatically run at the previously set parameter upon power restoration. The display window will flash. Press any button to stop the flashing.

Mechanical Zero Correction

To ensure accurate and quality rocking, the instrument will automatically run mechanical zero correction in the following situations:

1. First operation after the machine is turned on.
2. First operation after the rocking speed is reset.
3. After 8 hours of continuous operation.

5.4 Installation of Accessories

Only accessories that meet the manufacturer's specifications shall be used.

Installation of Double Tray

1. Place the Tube Rocker Stacking Bars on the base tray.

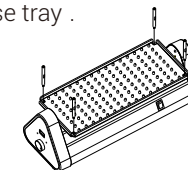

2. Stack the Double tier tube platform on the Bars.

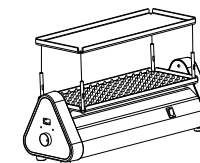

3. Tighten screws using a screw driver.

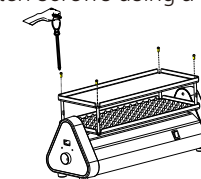

4. Place the Rubber Mat on the tray.

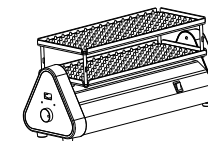

Section 6 Safety Tips and Maintenance

Safety Tips

1. Use independent power supply.
2. Check if the local power supply voltage is suitable for use.
3. Do not drag the power supply cable when unplugging.
4. Do not use non-specified power cable or damaged cable.
5. Service should only be performed by a qualified professional.
6. The power supply must be unplugged under the following situations:
 - (1). When the unit is moved
 - (2). When the electrical cabinet or the moving component is opened
 - (3). When the equipment is malfunctioning
 - (4). When the equipment is not in use.
7. Check that the instrument and the accessories are in good condition before each operation.

Cleaning

In order to ensure the safe use of the instrument, please follow the manufacturer's recommendations for cleaning when cleaning the instrument.

- Unplug the power first when cleaning.
- Wipe the instrument with a damp, soft cloth or non-corrosive cleaning agent.
- Direct spray instruments are prohibited.
- Make sure that the instrument is

- Please wear gloves when cleaning.

Warning: Avoid dripping detergent or water into the inside of the instrument during cleaning.

Clean Spill

If accidental spillage of liquids caused by mishandling or contained breakage occurs on the surface of the instrument, please shut down the instrument and clean up the liquid immediately.

If the liquid has already spilled into the unit, cut off the power supply first and immediately clean up the liquid at the surface of the instrument. Place the instrument in a ventilated and dry environment for 24 hours before reuse. If the instrument is not functioning after drying for 24 hours, please contact the manufacturer.

Warning: The operator is not permitted to gain access using a tool, to a part which in normal use may be hazardous live.





Section 7 Troubleshooting

Please refer to the following table to troubleshoot if any malfunction occurs.

If the problem still exists, contact your local sales representative.

Error	Cause	Solution
Cannot start instrument, LED display window off	Power disconnected	Connect the power
	Power switch off	Switch on power
	Power adaptor failure	Replace power adaptor
No shaking of the tray	Over-weighted	Adjust the weight , decrease rotation speed
	Electrical malfunction	Contact Thermo Scientific
	Mechanical malfunction	Contact Thermo Scientific
Loud noise	Housing loose	Fasten housing screws
	Tray loose	Fasten screws
	Instrument vibrate	Place instrument at a flat and firm surface
E1	Operational obstruction	Shut down and restart, useless, please contact Thermo Scientific
Other	Keep record for maintenance	

Section 8 Optional Accessories

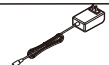
Description	Cat. No.	Dimensions	Max. Qty.	Figure
Double tier tube platform	88882158	330x140x12mm	1	
Tube Rocker Dimple Rubber Mat	88882159	323x133mm	1	
Tube Rocker Stacking Bars, 4ea	88882160	Φ8x60mm	4	
Screw GB/T9074.4 M3x6, 2ea	88882132	M3X6	2	
Multi-Power Adapter 220V	88870124	100~240VAC 1.0A 1.8m	1	
Power Adapter 120V	88870125	100~240VAC 1.0A 1.8m	1	

Note: For two trays application, please purchase 88882158, 88882159, 88882160 additionally.

Section 9 Warranty

THERMO FISHER SCIENTIFIC STANDARD PRODUCT WARRANTY

The Warranty Period starts two weeks from the date your equipment is shipped from our facility. This allows for shipping time so the warranty will go into effect at approximately the same time your equipment is delivered. The warranty protection extends to any subsequent owner during the first year warranty period.

During the first two (2) years, component parts proven to be non-conforming in materials or workmanship will be repaired or replaced at Thermo's expense, labor included. Installation and calibration are not covered by this warranty agreement. The Technical Services Department must be contacted for warranty determination and direction prior to performance of any repairs. Expendable items, glass, filters and gaskets are excluded from this warranty.

Replacement or repair of components parts or equipment under this warranty shall not extend the warranty to either the equipment or to the component part beyond the original warranty period. The Technical Services Department must give prior approval for return of any components or equipment. At Thermo's option, all non-conforming parts must be returned to Thermo Fisher Scientific postage paid and replacement parts are shipped FOB destination.

THIS WARRANTY IS EXCLUSIVE AND IN LIEU OF ALL OTHER WARRANTIES, WHETHER WRITTEN, ORAL OR IMPLIED. NO WARRANTIES OF MERCHANTABILITY OR FITNESS FOR A PARTICULAR PURPOSE SHALL APPLY. Thermo shall not be liable for any indirect or consequential damages including, without limitation, damages relating to lost profits or loss of products.

Your local Thermo Sales Office is ready to help with comprehensive site preparation information before your equipment arrives. Printed instruction manuals carefully detail equipment installation, operation and preventive maintenance.

If equipment service is required, please call your Technical Services Department at 1-866-984-3766, option number 2. We're ready to answer your questions on equipment warranty, operation, maintenance, service and special application. Outside the USA, please contact local Thermo Technical Services Department or local distributor for warranty information.

Section 10 Compliance

1. European Union

 The European voltage models of this product meet all the applicable requirements of the European Directives and therefore display the CE Marking. These Directives are captured in the EU Declaration of Conformity which may be obtained from the manufacturer.

2. Product Safety

This product family has been tested to applicable productsafety standards by a Nationally Recognized Test Laboratory (NRTL) and may bear the NRTL's mark of safety compliance to those applicable standards.

3. Electromagnetic Compatibility

3.1 FCC Statement (USA)

 Any changes or modifications not expressly approved by the party responsible for compliance could void the user's authority to operate the equipment.

Note: This equipment has been tested and found to comply with the limits for a Class B digital device, pursuant to part 15 of the FCC Rules. These limits are designed to provide reasonable protection against harmful interference when the equipment is operated in a commercial environment. This equipment generates, uses, and can radiate radio frequency energy and, if not installed and used in accordance with

the instruction manual, may cause harmful interference to radio communications. Operation of this equipment in a residential area is likely to cause harmful interference in which case the user will be required to correct the interference at his own expense.

3.2 Canadian ISED IC Notice

This ISM digital apparatus complies with Canadian ICES-001.
Cetappareil ISM estconformeà la norme NMB-001 du Canada.owing optimum tray rotation.

3.3 Korean KC Registration

 사용자안내문
이기는은업무환경에서사용할 목적으로적합성평가를받은기기로가정용환경에서사용하는경우전파 간섭의우려가있습니다

WARNING Statement: EMC Registration is done on this equipment for business use only. It may cause interference when the product would be used in home. This warning statement applies a product for business use.

4. Environmental Compliance

4.1 Evaluation of Chemicals - Regulations and Directives

4.1.2 REACH - Europe

 Thermo Fisher Scientific is committed to meeting all compliance obligations to evaluate, communicate, and register any Substances of Very High Concern (SVHC), and finding alternates where

appropriate.

4.1.2 RoHS - Europe

Thermo Fisher Scientific is determined to reduce the impact we have on the environment, and so can declare that this product fully complies with the European Parliament's RoHS2 (Restriction of Hazardous Substances) Directive 2011/65/EU, with respect to the limitation for the following substances:

- Lead (0.1 %)
- Mercury (0.1 %)
- Cadmium (0.01 %)
- Hexavalent chromium (0.1 %)
- Polybrominated biphenyls (PBB) (0.1 %)
- Polybrominated diphenyl ethers (PBDE) (0.1 %)

2015/863 Annex II (RoHS2 Amendment, In effect after July 22, 2021)

- Bis(2-ethylhexyl) phthalate (DEHP) (0.1 %)
- Butyl benzyl phthalate (BBP) (0.1 %)
- Dibutyl phthalate (DBP) (0.1 %)
- Diisobutyl phthalate (DIBP) (0.1 %)

Our compliance is witnessed by written declaration from our suppliers and/or component testing. This confirms that any potential trace contamination levels of the substances listed above are below the maximum level set by the latest regulations or follow established

exemptions of the regulation due to their application.

4.1.3 RoHS - China

This product complies with the requirements of the legislative act Administration on the Control of Pollution Caused by Electronic Information Products (ACPEIP). A label of conformance, such as one of the following, may be found on the product:



5. End of Life Care

Some considerations and suggestions are listed below for proper disposal of this product. While addressing these actions for safe recycling and disposal, please follow all guidelines, Safety Data Sheets (SDS), or regulations applicable to your location.

- This product has materials and components that may be recycled or reused according to local guidelines and regulations.
- Clean up any chemical or biological safety hazards.



WEEE Compliance. This product is required to comply with the European Union's Waste Electrical & Electronic Equipment (WEEE) Directive 2012/19/EU. It is marked with the following symbol. Thermo Fisher Scientific has contracted with one or more recycling/disposal

companies in each EU Member State, and this product should be disposed of or recycled through them. Further information on our compliance with these Directives, the recyclers in your country, and information on Thermo Scientific products which may assist the detection of substances subject to the RoHS Directive are available at www.thermofisher.com/