

NEW: Adjustable  
tip spacing pipettes



# Move It!

Eppendorf Research® plus and Eppendorf Xplorer® plus Move It® adjustable tip spacing pipettes  
Fast and secure transfer of multiple samples between different formats

# Double Your Performance

## Maximizing efficiency

Do you frequently switch between different consumable formats such as tubes to plates? With the new Move It pipettes you can easily switch between various formats; reducing your throughput time by 50% while increasing reproducibility.

## Safe sample transfer

For a safe sample transfer, the spacing adjustment is vibration-free, easy, and fast. By just a simple turn of the adjustment knob, the tip distance is modified.

## 1. Maximizing Efficiency

### Easy and fast format change

Often, single channel pipettes are used for multiple sample transfer from one vessel type to another. This can be time-consuming and inconvenient, especially when throughput increases.

Multiple sample transfers between different vessel types and formats become possible with the new Move It pipettes. Instead of pipetting many times, four to twelve samples can now be transferred simultaneously. This not only saves you valuable time, it further increases the reproducibility of your results.

### Defined settings for quick switches

Switching between source and destination vessels made simple by using the format limiters. These pipettes can easily be adjusted manually with pre-defined settings for different plate formats. All you have to do is to set the format limiters to 384-, 96-, 48-, 24- or 12-well plates using the indicated scale. This enables quick switches back and forth, between two formats, by manually operating the adjustment knob.

### Example applications

- > Blood analysis
- > FACS analysis
- > Cell Based Assays
- > Cell Culture
- > ELISA
- > PCR
- > Mouse genotyping

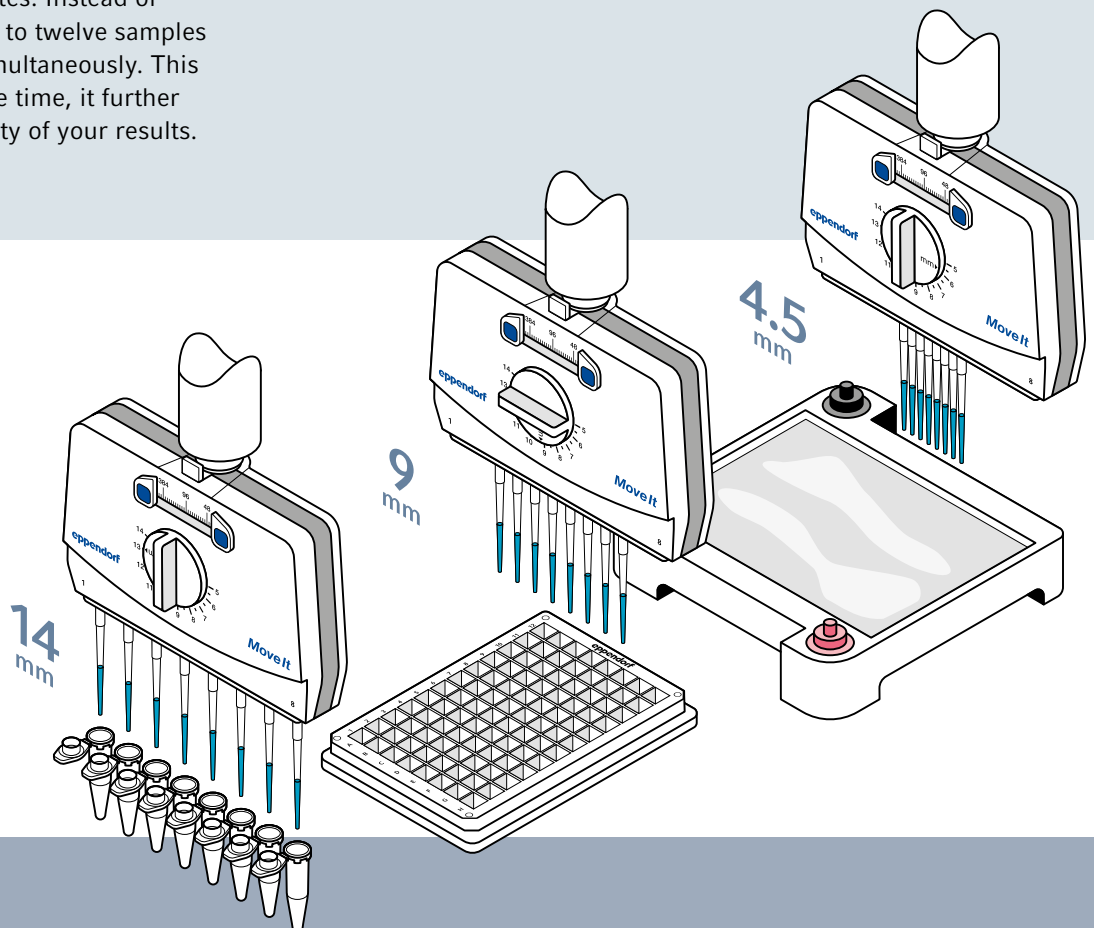

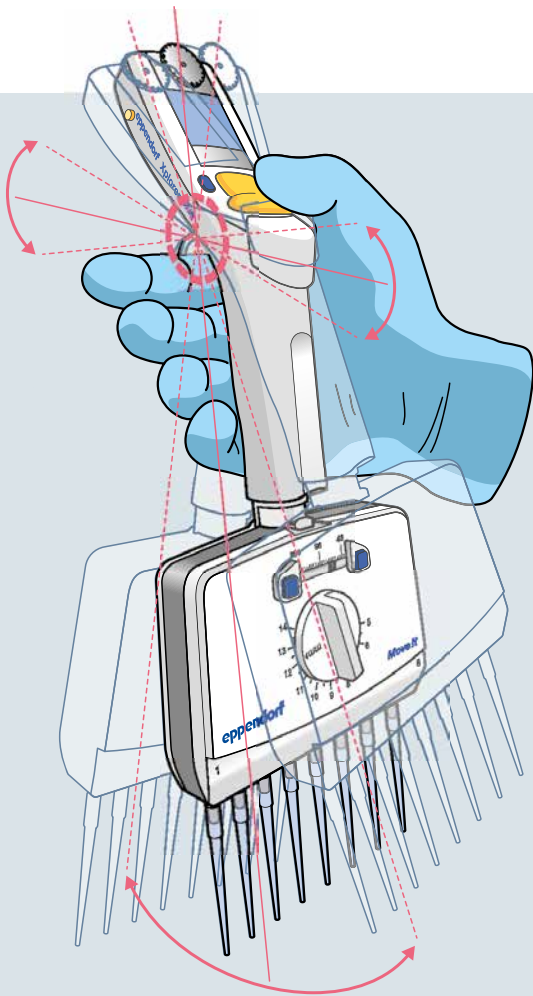

### Optimal balance for a relaxed hand

Need a break? With a natural and relaxed hand position the demand for a break decreases. Move It pipettes reduce hand fatigue to a minimum. This is achieved by an optimized balance of the pipette. The user also benefits from convenient visibility of tips and samples. Enjoy a stress-free operation the whole day long.

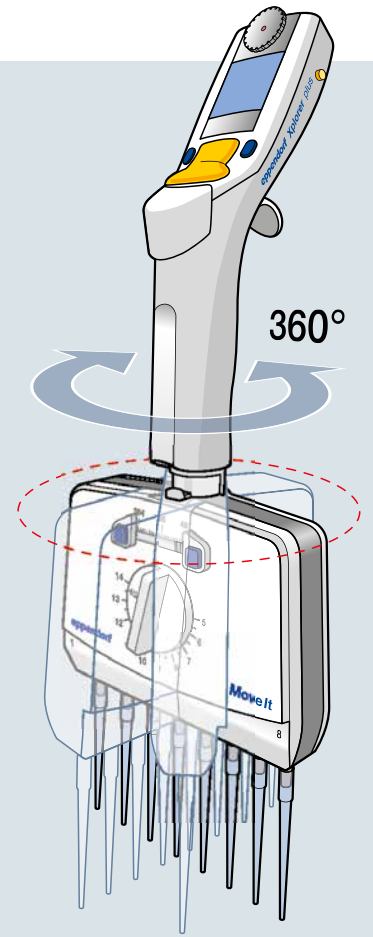

### Rotating pipette head – 360°

All Move It pipettes are designed without the need of tubing. Thus, the pipette head is completely rotatable. The user benefits from comfortable readability of the display. This not only supports an ergonomic and relaxed body posture, it also ensures fast identification of all parameters; saving you valuable time.

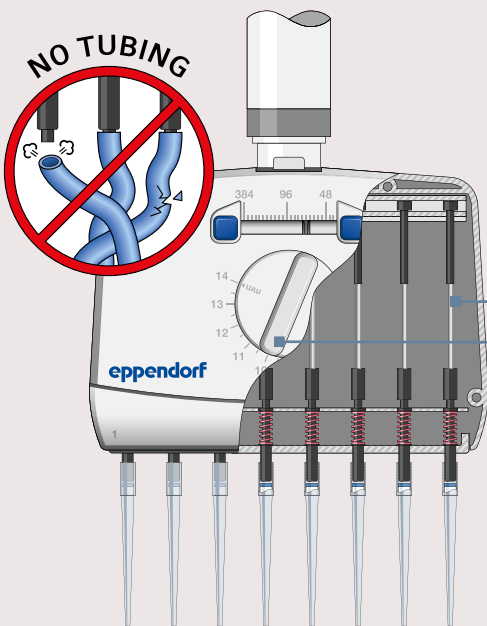

## 2. Safe Sample Transfer

### Tubeless system for reliability and reproducible results

The piston-cylinder system is directly connected to the cone. The user therefore benefits from special advantages:

- > Lack of heat transfer to air-cushion from motor or hand – for stable temperature for higher precision and reproducibility
- > Easy autoclavability\* – for reduced contamination risk
- > Lack of possible cable tangle and tubing-porosity – for consistently reliable robustness and precision
- > Less maintenance requirements compared to pipettes with tubing system

### Adjustment knob for smooth liquid transfer

Since no motor is used, format changes don't cause vibrations enabling liquid transfers without the risk of dripping.

\* Xplorer plus lower part and Research plus fully autoclavable

> Find more information on the Eppendorf PhysioCare Concept® on [www.eppendorf.com/physiocare](http://www.eppendorf.com/physiocare)



# Move It Keeps The Balance For You

## Business Manager Peter Schmidt

When developing the adjustable tip spacing pipettes, our goal was to keep the ideal balance in the hand. As the lower part of the pipette gained weight, we faced a challenge. An external study revealed that a good balance is more important for the user than the total weight. Encouraged by this, we replaced some inner parts of the pipette with metal parts. The result is a well-balanced pipette supporting ergonomic working conditions.



## Move It – You have the choice

Mechanical Research plus pipettes are the workhorses for each lab. The Xplorer electronic pipettes are the ideal instrument if you need intuitively and precisely adjustable parameters. They allow for reproducible and accurate results while letting you experience fatigue-free pipetting.



### Rotatable lower part – 360°

- > Comfortable readability of display
- > Ergonomic and relaxed body posture
- > Fast identification of parameters

### Format limiter

- > For adjusting source and destination formats
- > Easy assignment to 384-, 96-, 48-, 24-, and 12-well plates
- > Quick switches backwards and forwards between the formats

### Adjustable tip spacing

- > For microplates, reaction tubes, agarose gels and further formats
- > Tip spacing freely selectable between 4.5 and 33 mm

### Adjustment knob

- > Tip spacing adjustable manually
- > Intuitive, direct, and vibration-free
- > Liquid transfers without dripping

### Tubeless system

- > Stable temperature in air-cushion
- > Consistently reliable robustness and precision
- > Easy autoclavability\*
- > Reduced maintenance requirements



\* Xplorer plus lower part and Research plus fully autoclavable

> More information about Move It  
Click or scan to follow:  
[www.eppendorf.com/Move-It](http://www.eppendorf.com/Move-It)



All models available as electronic Xplorer plus and mechanical Research plus.

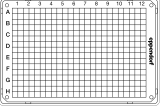
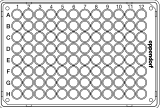
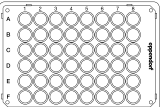
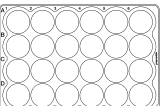
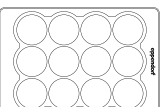
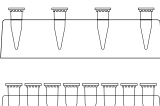
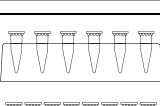
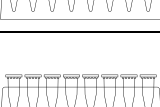
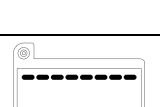

Vessel Format	Type of tips	epT.I.P.S. <sup>®</sup>			epT.I.P.S. <sup>®</sup> 384	
	Pipette Electronic Mechanical	Eppendorf Xplorer <sup>®</sup> plus, Eppendorf Research <sup>®</sup> plus			Eppendorf Xplorer <sup>®</sup> plus, Eppendorf Research <sup>®</sup> plus	
	No. of channels	4	6	8	8	12
	Volume (µL)	300 / 1,200	300 / 1,200	300 / 1,200	20 / 100	20 / 100
	Tip distance (mm)	9–33	9–20	9–14	4.5–14	4.5–9
	<b>384 Wells</b> (Tip distance 4.5 mm)	–	–	–	■	■
	<b>96 Wells</b> (Tip distance 9 mm)	■	■	■	■	■
	<b>48 Wells</b> (Tip distance 13 mm)	■	■	■	■	–
	<b>24 Wells</b> (Tip distance 19 mm)	■	■	–	–	–
	<b>12 Wells</b> (Tip distance 26 mm)	■	–	–	–	–
	<b>1.5 / 2.0 / 5.0 mL Tube</b> (Tip distance min. – max.: 9 mm – 33 mm)	■	–	–	–	–
	<b>1.5 / 2.0 / 5.0 mL Tube</b> (Tip distance min. – max.: 9 mm – 20 mm)	–	■	–	–	–
	<b>1.5 / 2.0 / 5.0 mL Tube</b> (Tip distance min. – max.: 9 mm – 14 mm 4.5 mm – 14 mm)	–	–	■	■	–
	<b>Agarose gel</b>	■*	■*	■*	■	■

\* Limited suitability due to volume and size of tips



> Speed up your laboratory work and go to:  
<https://handling-solutions.eppendorf.com/liquid-handling/pipetting-facts/time-saving/>

**Eppendorf Research® plus MoveIt®**

(mechanical multi-channel pipettes, adjustable cones, variable volume)

No. of channels	Volume	Color code	Order no.
4-channel	30–300 µL	orange	3125 000 150
	120–1,200 µL	dark green	3125 000 184
6-channel	30–300 µL	orange	3125 000 168
	120–1,200 µL	dark green	3125 000 192
8-channel	1–20 µL	light pink	3125 000 117
	5–100 µL	light yellow	3125 000 133
	30–300 µL	orange	3125 000 176
12-channel	120–1,200 µL	dark green	3125 000 206
	1–20 µL	light pink	3125 000 125
	5–100 µL	light yellow	3125 000 141

**Eppendorf Xplorer® plus MoveIt®**

(electronic multi-channel pipettes, adjustable cones, variable volume, incl. charger)

No. of channels	Volume	Color code	Order no.
4-channel	15–300 µL	orange	4861 000 816
	50–1,200 µL	green	4861 000 833
6-channel	15–300 µL	orange	4861 000 817
	50–1,200 µL	green	4861 000 834
8-channel	1–20 µL	light pink	4861 000 781
	5–100 µL	light yellow	4861 000 794
	15–300 µL	orange	4861 000 818
12-channel	50–1,200 µL	green	4861 000 835
	1–20 µL	light pink	4861 000 782
	5–100 µL	light yellow	4861 000 795

**ep Dualfilter T.I.P.S.® 384**

Purity grade	Type of packaging	Tip size	Color code	Smallest tip distance	Order no.
Rack (PCR clean, sterile)	ep Dualfilter T.I.P.S.® 384, 3,840 tips (10 racks × 384 tips)	0.1–20 µL	light pink	4.5 mm	0030 078 403
		0.5–100 µL	light yellow	4.5 mm	0030 078 411

**ep Dualfilter T.I.P.S.®**

Purity grade	Type of packaging	Tip size	Color code	Smallest tip distance	Order no.
Rack (PCR clean, sterile)	ep Dualfilter T.I.P.S.®, 960 tips (10 racks × 96 tips)	20–300 µL	orange	9 mm	0030 077 563
	ep Dualfilter T.I.P.S.®, 480 tips (5 racks × 96 tips)	50–1,250 µL L	dark green	9 mm	0030 078 594

> Find the entire product range of tips at [www.eppendorf.com/tips](http://www.eppendorf.com/tips)



> For more information on pipette service go to [www.eppendorf.com/epServices](http://www.eppendorf.com/epServices)

Your local distributor: [www.eppendorf.com/contact](http://www.eppendorf.com/contact)

Eppendorf AG · Barkhausenweg 1 · 22339 Hamburg · Germany  
[eppendorf@eppendorf.com](mailto:eppendorf@eppendorf.com) · [www.eppendorf.com](http://www.eppendorf.com)

[www.eppendorf.com](http://www.eppendorf.com)