

# Sediplus® S 2000, 230V Operating Manual

SARSTEDT No. 90.189 700



CE

For in vitro diagnostics

## Basic information!



**Please note the information provided in this operating manual before commencing use of the Sediplus® S 2000!**

Knowledge of the contents of this operating manual is the basic precondition for correct use and handling and trouble-free operation of the instrument.

### Copyright:

**The copyright for this operating manual resides with SARSTEDT AG & Co. The operating manual is intended only for the operating staff and for the purchaser of the instrument.**

This operating manual may be copied, distributed or otherwise communicated to third parties in part or in whole only with the written agreement of SARSTEDT AG & Co.

No part of this manual may be reproduced in any way and/or copied using electronic processing systems in any form whatsoever (photocopy or other methods) without the written approval of SARSTEDT AG & Co.

Infringements of the above provisions may have civil and/or criminal law consequences.

**Please keep the operating manual available as a source of basic information for your instrument.**

**Right of technical modification reserved!**

Sediplus®, Sedivette®, Sarmix® and Monovette® are registered trademarks of SARSTEDT AG & Co.

Nümbrecht, August 2004  
**SARSTEDT AG & Co**

Address of manufacturer/ After-Sales Service	Instrument data: (to be completed by the customer)
<p><b>SARSTEDT AG &amp; Co</b>                      P.O. Box 1220                      D-51582 Nümbrecht                      Germany</p> <p>Telephone     +49 (0) 22 93-30 50</p> <p>Telefax:        +49 (0) 22 93-305 282</p> <p>E-Mail:         info@sarstedt.com</p>	<p>Typ:              <b>Sediplus® S 2000, 230 V</b>                                          <b>[ ] Expansion module for</b>                                          <b>Sediplus® S 2000</b></p> <p>Serial No.:       _____</p> <p>Installation location: _____</p> <p>Date of installation: _____</p> <p>Inventory No.:    _____</p> <p>EPROM No.:     _____</p>

<b>Table of contents</b>	<b>Page</b>
<b>Basic information!</b> .....	<b>2</b>
<b>Table of contents</b> .....	<b>3</b>
<b>1 General information</b> .....	<b>5</b>
1.1 Symbols and Notes on Safety .....	5
1.2 Notes on Safety .....	6
<b>2 Introduction</b> .....	<b>7</b>
2.1 Description .....	7
2.2 The "Blood sedimentation" variable .....	7
2.3 Technical data .....	8
2.4 Unpacking .....	9
2.5 Scope of supply .....	9
2.6 Setting-up and installation of the instrument .....	10
2.6.1 Connection of expansion modules to the Sediplus® S 2000 .....	11
2.6.2 Connection of a PC-AT keyboard and/or a barcode reader .....	12
2.6.3 Entry of options .....	15
2.6.3.2 "Measurement at ½h/1h" option .....	17
2.6.3.3 "Language" option .....	17
2.6.3.4 "Reset consecutive identification number" option .....	17
2.6.3.5 "Set time/date" option .....	18
2.6.3.6 "Raise instrument plate for cleaning" function .....	18
2.6.3.7 "Automatic issue of consecutive identification number: Yes/No" function .....	18
2.6.3.8 "Underfilling limit 5 to 15 mm" function .....	19
2.6.4 Description of the serial interface .....	20
<b>3 The functional elements of the Sediplus® S 2000</b> .....	<b>22</b>
3.1 The instrument plate .....	22
3.2 The LEDs on the instrument plate .....	23
3.3 The display .....	24
<b>4 Operation of the Sediplus® S 2000</b> .....	<b>25</b>
4.1 Switching on the instrument .....	25
4.2 Preparation of specimens .....	25
4.3 Insertion of the Sedivette® and starting of a measurement .....	26
4.4 Entry of the identification number .....	28
4.4.1 Entry of the identification number using a barcode reader (optional) .....	28
4.4.2 Entry of the identification number using a PC-AT keyboard (optional) .....	30
4.5 Viewing of values already determined during a measurement .....	31
4.6 Acoustic assistance .....	32
4.7 Erasure of all data .....	33
4.8 Renewed print-out / Repeat print-out operation .....	33
<b>5 Malfunctions and operating errors</b> .....	<b>34</b>
5.1 Obstruction of instrument plate's upward and downward movement .....	34
5.2 Underfilling of the S-Sedivette® .....	34
5.3 Incorrect measurement .....	36
5.4 Premature removal of a Sedivette® .....	37
5.5 Power failures .....	39

<b>6</b>	<b>Cleaning the instrument</b>	<b>40</b>
<b>7</b>	<b>Service and maintenance</b>	<b>41</b>
<b>8</b>	<b>Decommissioning and disposal</b>	<b>41</b>
<b>9</b>	<b>Ordering information</b>	<b>42</b>
<b>10</b>	<b>Guarantee and liability</b>	<b>42</b>
<b>11</b>	<b>Glossary</b>	<b>43</b>
<b>12</b>	<b>Index of illustrations</b>	<b>43</b>
<b>13</b>	<b>References</b>	<b>43</b>
<b>14</b>	<b>Index</b>	<b>44</b>
<b>15</b>	<b>Contamination Questionnaire</b>	<b>44</b>
<b>16</b>	<b>Annex</b>	<b>46</b>
16.1	Initialization of the optional barcode reader	46
16.2	Serial connecting cables	48

## 1 General information

---

### 1.1 Symbols and Notes on Safety

---

This operating manual contains the following important symbols to draw attention to hazards and potential operating errors. The "Notes on Safety" contain information on the safe handling and use of the Sediplus® S 2000.



This "Attention" symbol signifies that the section indicated contains:

- important notes
- a description of a direct or possibly threatening hazard for life and limb
- a reference to potentially dangerous situations

Failure to adhere to this symbol may result in injuries ranging from slight to potentially lethal and/or to damage to property.



Warning concerning hazardous electrical voltages!



This "Information Symbol" provides an indication of information concerning the correct use and handling of the instrument and/or of general information for improved comprehension. Failure to adhere to these notes may result in the instrument being incorrectly operated or even damaged.



This "Tip" symbol provides the reader with tips concerning use of the instrument or particularly useful information for optimum utilization of the instrument.

Further symbols indicate the subject stated by the symbol, such as the Accident Prevention Regulations, for example, the necessary power (voltage) supply, maintenance and/or disposal, etc..

## 1.2 Notes on Safety



The Sediplus® S 2000 blood sedimentation analyzer is designed and constructed in accordance with the latest technological status and the acknowledged rules of safety. Please note and adhere to the relevant notes on safety and guidelines and to the Industrial Health and Safety and Accident Prevention Regulations for use in the laboratory.

It is nonetheless possible during use of the instrument for hazards to occur for the user, for third parties and/or for the instrument itself and/or other property.

The instrument is intended for use only:

- for the proper and correct use
- in perfect safety-relevant condition

During the guarantee period, the instrument may be repaired only by SARSTEDT AG & Co or by persons authorized by SARSTEDT AG & Co. Incorrect/unauthorized handling and/or repair of the instrument will result in loss of validity of any and all guarantee claims.



The instrument is operated at a voltage of 230 V, 50 to 60 Hz. No water or other liquids may be allowed to enter the instrument.

- Only the mains connecting lead supplied with the instrument may be used for connection of the instrument to the mains supply.
- Always check that the mains voltage accords with the data shown on the instruments model plate. The instrument may be connected only to an earthed (grounded) safety-contact plug socket.
- Always check the connecting lead for damage prior to use of the instrument. Damaged leads must never be used.
- Always check the instrument itself for visible exterior damage before use! Never use a damaged instrument.
- Always remove the plug from the socket if the instrument is not to be used for a prolonged period and also if it is to be cleaned.

The Sedivettes and the blood specimens in the Sedivettes must under all circumstances be correctly handled and disposed of. Please note and adhere to the regulations applicable in your country and adhere to the safety regulations in your laboratory.



The instrument may be used and augmented only with the accessories described in this operating manual.

### THE OPERATOR'S OBLIGATIONS

The operator of the instrument is obliged to entrust work with and on the instrument only to persons who have read and understood this operating manual. This fact should be confirmed by means of the signature of such persons.

The safety-aware manner of working of the operating staff should be checked at regular intervals.

### THE OBLIGATIONS OF THE OPERATING STAFF

Persons who perform work with or on the instrument hereby undertake:

- to read this operating manual prior to commencing work with or on the instrument and
- to note and adhere to the applicable rules and regulations for prevention of accidents

Both of these undertakings should be confirmed by the signature of the relevant persons.

## 2 Introduction

---

### 2.1 Description

---

Thanks to the use of an infrared-transmission measurement process and of ultra-modern microprocessor electronic technology, and on the basis of SARSTEDT's many years of experience in the field of blood sedimentation, the Sediplus® S 2000 constitutes an automatic forty channel blood sedimentation analyzer.

The Sediplus® S 2000 has been specially developed for large-scale laboratories with a high number of specimens requiring processing and central blood sedimentation processing. After completion of measurements, the results can be fed into a computer system. Manual viewing of data is, of course, possible at any time using the LCD display.

The basic module, with 40 measuring places, is made up of the operating panel and can be expanded up to a maximum of 160 measuring places, with up to three expansion modules.

Optimum combination with the Sedivette® blood sedimentation system makes it possible to perform blood sedimentation at any time, immediately following safe obtainment of a blood specimen.

After mixing, measurement starts with insertion of the filled Sedivette® into a vacant measuring position.

After insertion of the Sedivette® into any available measuring position, the instrument detects the new Sedivette® and measurement is started. Premature removal of the Sedivette is also detected and indicated as an error.

The measuring times and results of all positions are shown on the display.

The instrument plate is raised and lowered for the measuring procedure. Each Sedivette® is through-illuminated by a measuring beam during this process. The beam of light strikes a detector behind the Sedivette®. The surface of the layer of the erythrocytes is detected by a change in light intensity.

Correct identification of the specimen is assured by means of the facility for connection of a barcode reader. The status for each of the forty channels of the basic module and of any expansion modules can be viewed at any time and is shown on the LCD display.

After completion of measurements, the result record can be outputted via the built-in interface to the computer system or printed out via a serial printer, complete with 1h and 2h values (and, optionally, also ½h and 1h values), date (with two- or four-digit statement of year), time and identity number via the LCD display.

### 2.2 The "Blood sedimentation" variable

---

"Blood sedimentation", also referred to as the erythrocyte sedimentation rate (ESR or BSR = (red) blood corpuscle sedimentation rate) can, in accordance with DIN 58935, Part 1, NCCLS H2-A3 and BS 2554, be defined as: The distance (length), in blood rendered non-coagulable, between the liquid surface of the plasma and the sedimentation surface of the red blood corpuscles stated in mm. Sedimentation should occur at room temperature in a sedimentation tube of defined height and defined cross-section. Rate of sedimentation under the influence of gravity is determined after 1 h in mm using the Westergren method.

For the purpose of performance of blood sedimentation, 2.8 ml of venous blood is absorbed in 0.7 ml sodium citrate solution in the SARSTEDT S Sedivette®, thoroughly mixed in the S Sedivette®, and placed vertically in the mounting of the Sediplus® S 2000.

The Sediplus® S 2000 measures the difference in height between the lower meniscus of the liquid surface of the plasma and the sedimentation surface of the red blood corpuscles. The sedimentation values of the citrated blood are measured at defined times, converted to mm, and outputted in x mm/h using the standardized Westergren method after 1 hour. In addition, the Sediplus® S 2000 also makes it possible to output the sedimentation values after 2 hours in y mm/2h."

## 2.3 Technical data

Manufacturer's and instrument data	
Instrument:	Sediplus® S 2000, 230 V
Order number:	SARSTEDT No. 90.189 700
Manufacturer:	SARSTEDT AG & Co.
Address:	P.O. Box 1220 D-51582 Nümbrecht, Germany
<b>Instrument data:</b>	
Measuring principle:	Infrared transmission measuring process with extraneous light compensation Blood sedimentation measurement in the SARSTEDT Sedivette® Conversion to Westergren values
Measuring accuracy:	± 1 mm of measured path
Measuring range:	0 to 70 mm, equating to a sedimentation value range of 0 to 147 mm as per Westergren. Since the Sedivette® has a larger diameter and is shorter than the Westergren sedimentation tube, the sedimentation value determined is mathematically converted to Westergren values and displayed by the Sediplus® S 2000.
Display:	Measuring time in hours and minutes Measured value in millimeter (Westergren values) LCD for status, information and error messages 40 x LED status monitoring of the measuring places
Interfaces:	RS 232 (V.24) interface for connection to a printer or a computer-system. Protocol, see Section: 2.6.4, "Description of serial interface". Five-pole DIN socket for connection of optional barcode reader and/or a PC-AT keyboard for data input and/or operation. 25-pole D-SUB interface on rear panel for connection of expansion modules.
Specimen holder:	SARSTEDT Sedivette®
Measuring places:	Basic module: 40 positions Expansion module (optional), 40 positions each A maximum of three expansion modules can be connected to a basic module.
Measured-data memory:	A memory for a complete record is available for each position.
Data storage:	Data (measured data, date and time) are preserved by means of a built-in battery in case of power failure
Data output to:	- Display - via RS 232 to a serial printer or a - computer-based data processing system
Power supply:	230 V~ (-10/+10 %), 50-60 Hz
Power take-up:	50 W
Fuses:	0.25 AT (two items fusible cutouts, 5 x 20 mm)
Dimensions:	Width: 315 mm Depth: 326 mm Height, not inc. Sedivettes: 175 mm (instrument plate retracted) Height including inserted Sedivettes: 270 mm
Weight:	5 kg
Permissible ambient conditions for storage of the instrument:	+ 10° C to +40° C, rel. air humidity max. 80 %, non-condensing
During operation:	Room temperature (18° C to 23° C or as per national or laboratory specific definition), at max. 80 % rel. air humidity, non-condensing



## 2.4 Unpacking

---

The Sediplus® S 2000, 230 V (SARSTEDT No. 90.189 700) or the expansion module for the Sediplus® S 2000 (SARSTEDT No. 90.189 710) is in each case packed in a carton, complete with all accessories.



Please check that the carton and the instrument itself are in correct and undamaged condition. Please contact the carrier immediately in case of any transportation damage! Please note the notification period for the individual transportation companies (railroad, post, parcels services and freight carriers). This may in some cases be only 24 hours. Any and all deficiencies and damage must be notified to SARSTEDT AG & Co. immediately!  
Please check the scope of supply using the list provided in the next section.

## 2.5 Scope of supply

---

The Sediplus® S 2000, 230 V (SARSTEDT No. 90.189 700) consists of:

Quantity	Description
1	Basic module
1	Mains lead
1	Anti-dust cover
1	Operating manual

The expansion module for the Sediplus® S 2000 (SARSTEDT No. 90.189 710) consists of:

Quantity	Description
1	Expansion module
1	Connecting lead for connection to basic module/expansion module
1	Anti-dust cover

## 2.6 Setting-up and installation of the instrument

---

Attention must under all circumstances be devoted to the following items during the setting-up and installation of the instrument, since the BSR can be influenced by numerous sources of error:



- Vibration of the filled sedimentation system will cause excessively high sedimentation values.  
For this reason the instrument must be positioned on a stable table or another vibration-free surface.  
The instrument must not be positioned on the same laboratory bench as a centrifuge, for example (source of vibration).
- The S-Sedivettes must under no circumstances be scratched, dusty or otherwise dirty or contaminated.
- Inclination of the filled sedimentation system will cause excessively high sedimentation values.  
The instrument must therefore be installed in such a way that the S-Sedivettes are positioned vertically and the S-Sedivettes can be inserted from above.
- During the measuring operation, the instrument plate moves upward. For this reason, ensure sufficient space, in order that it is possible to work without obstruction.
- Deviations and fluctuations (drafts) in room temperature will result in falsification of the sedimentation values.  
For this reason, the instrument must not be installed in the vicinity of radiators or other sources of heat.
- The specimens must not be taken immediately from the refrigerator and then used for analysis in the S 2000. It is decisive for the correctness of the results that the specimens are always at room temperature for testing (18° C to 23° C or in accordance with national or laboratory-specific definition).
- Direct exposure to sunlight or other sources of light must be avoided under all circumstances.
- A distance of not less than 10 cm from walls and other objects must be maintained, in order to assure adequate ventilation of the instrument's electronics.
- Always keep the measuring optics scrupulously clean. In particular, no splashes of blood or plasma may be allowed to enter the optics.
- Protect the instrument against dust and other fouling, etc., by covering it with the anti-dust cover after use.



Connect the instrument to the power supply. The mains plug and mains switch, together with the fuses, are located on the rear panel of the instrument at the left. The notes on safety must be read and adhered to before connecting the instrument to the mains.

Ensure adequate spacing from other equipment, in order that there is sufficient space for operation and that the function of the instrument is not impaired.

It must be possible to reach and operate the mains switch on the rear of the instrument. Only switch the mains supply for the Sediplus® S 2000 on once all peripherals (barcode reader, expansion module(s) and/or PC-AT keyboard) have been correctly connected to the basic module.

## 2.6.1 Connection of expansion modules to the Sediplus® S 2000



**Important!**

The Sediplus® S 2000 basic module must under all circumstances be disconnected from the power supply when connecting or disconnecting one or more expansion modules!

A 25-pole D-SUB socket is located on the rear of the Sediplus® S 2000 basic module.

A 25-pole D-SUB socket and a 25-pole D-SUB connector are located in each case on the rear of the expansion module(s).

A connecting lead (25-pole D-SUB connector/socket) is supplied with each expansion module.



Abbildung 1 Rear view of the basic module (right) and two expansion modules



**Please note:**

The socket on any unit is always the output and the connector the input of the unit (Sediplus® S 2000 or expansion module).

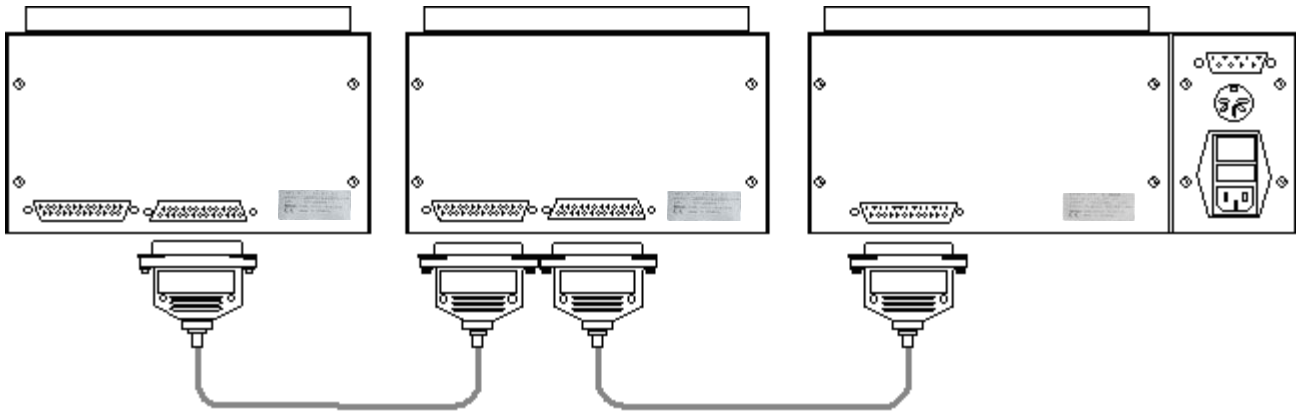
**This means:**

The socket of the basic module must always be connected to the connector of the next expansion module.

For connection of more than one expansion module, the socket of the first (previous) expansion module should be connected to the connector of the second (next) expansion module.

**Only use the 25-pole connecting lead supplied with each expansion module for connection of expansion modules.**

The expansion modules are controlled and supplied with power by the basic module. Operation is also accomplished via the basic module.

**A maximum of three expansion modules can be connected to a basic module.**

## 2.6.2 Connection of a PC-AT keyboard and/or a barcode reader



**Important!**  
The Sediplus® S 2000 basic module must under all circumstances be disconnected from the power supply when connecting or disconnecting one or more peripherals (barcode reader, PC-AT keyboard, computer system and/or serial printer)!

Further interfaces for peripherals are located adjacent to the 25-pole D-SUB socket for connection of expansion modules on the rear of the Sediplus® S 2000:



Abbildung 2: The rear panel of the Sediplus® S 2000



A barcode reader or a PC-AT keyboard can be connected to the 5-pole DIN connecting socket, using the adapter.

If you are using the barcode reader for the Sediplus® S 2000, a PC-AT keyboard can also be used in addition to the barcode reader. The PC-AT keyboard can in this case be used in parallel to the operating panel and the barcode reader.

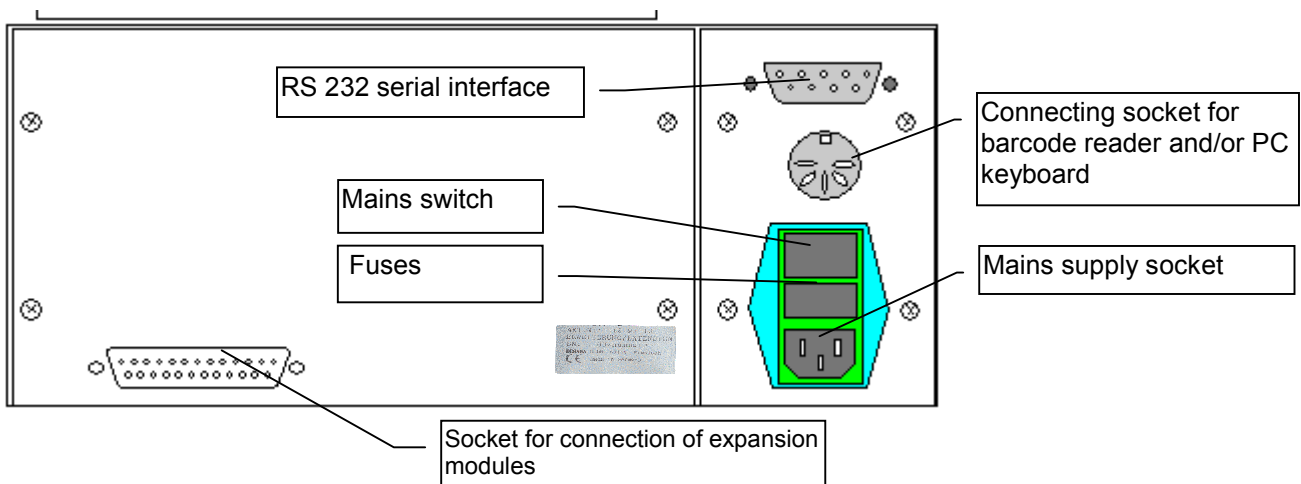
The connections for the three units (S 2000, optional SARSTEDT barcode reader and PC-AT keyboard) can be seen in the following illustration:



Abbildung 3: Connection of a keyboard and the optional barcode reader to the Sediplus® S 2000

The PC-AT keyboard can be used immediately after switching-on of the Sediplus® S 2000.

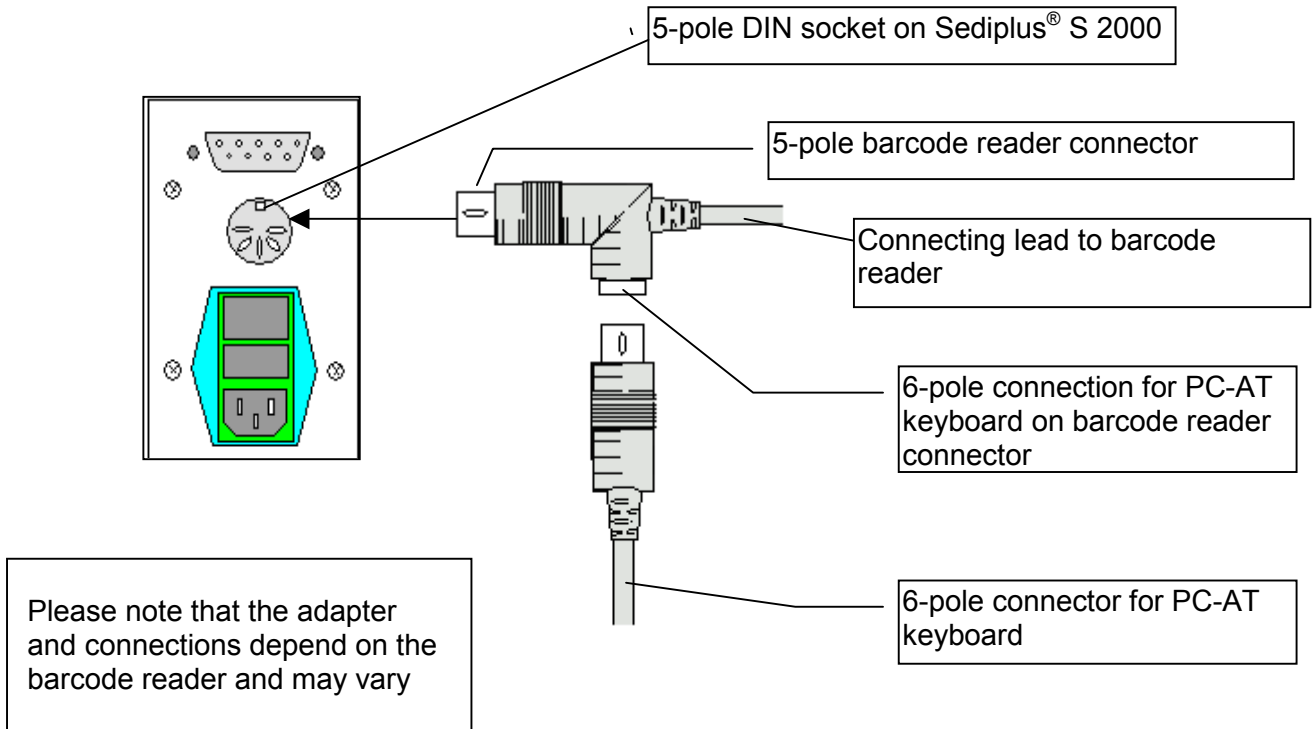

The optional SARSTEDT **barcode reader** is pre-programmed and initialized for the following codes:

- |           |                      |                   |
|-----------|----------------------|-------------------|
| - Code 39 | - UPC-A/UPC-E        | - 2/5 interleaved |
| - Codabar | - MSI                | - Code 128        |
| - Code 11 | - Code 39 Full ASCII | - EAN-8/EAN-11    |

The reason for a barcode reader not detecting the barcode viewed, reading it incorrectly or adding characters (e.g. preceding zeros) is often that a different code is used for the barcode (e.g. transmission of check sums).

In this case, it is necessary to reprogram the barcode reader to the code you are using.

Please check for this purpose the notes and remarks in the operating manual supplied with the barcode reader.

A plastic mounting is supplied with the optional barcode reader. Please fix this barcode-reader mounting as follows to the side of the instrument housing:

- Firstly remove the double-sided adhesive tape
- Press the mounting against the housing (at the right or the left), as shown in the diagram below
- The barcode reader can be inserted into the mounting from above. The mounting serves, on the one hand, as a storage place and, in addition, the Sedivettes bearing the barcode (adhesive tape) can be held up to the barcode reader before they are inserted into the instrument. The operator's hands are therefore kept free, and the Sedivette® is vertical during reading of the barcode.
- Remove the barcode reader upward from the mounting if reading off the barcode from a patient's record sheet

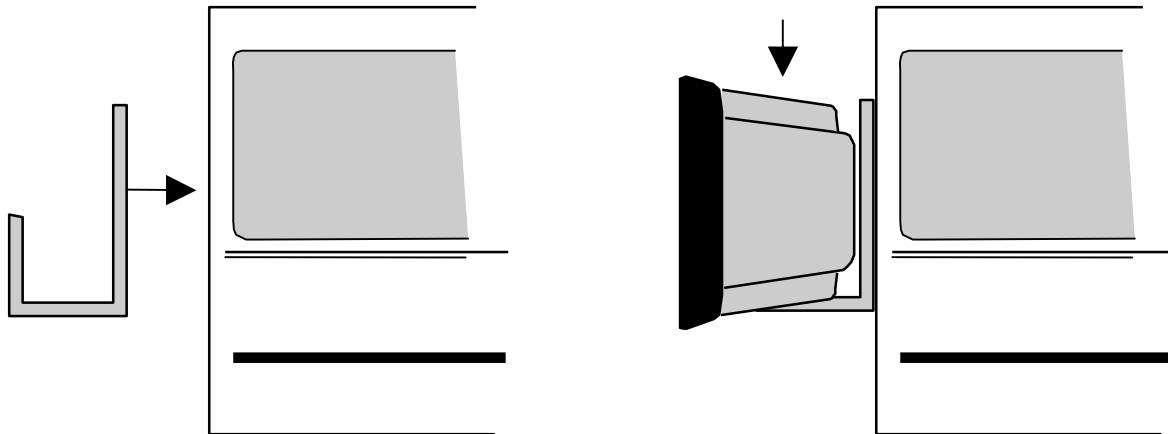

The red LEDs illuminate when the barcode reader is switched on.

- Please see the operating manual supplied with the optional barcode reader for more information on the barcode reader.

## 2.6.3 Entry of options



The Sediplus® S 2000 provides a facility for selection of a number of options and parameters prior to use.

The options menu is described in the following sections. Please also read this section of the operating manual carefully and select your setting for the various options and parameters.

Switch the instrument on after installing the basic module and peripherals. Keep the [ENTER] key pressed during this.

The Options menu will appear on the display.

This menu contains eight items; menu item [1] also features a sub-menu. Menu items 5 to 8 can be found on a "new page" on the display. It is possible to leaf between the two "pages" using the arrow keys.

[1] Output measuring record: Yes
[2] Measure at 1h/2h
[3] Language: English
[4] Reset consecutive ID number

- Use the numerical keys to select the option or parameter which you wish to set or change
- Switch the instrument off after editing the parameters and options
- Every change is stored immediately and does not need to be confirmed (exception: Resetting of consecutive ID number)
- The modified settings apply when the Sediplus® S 2000 is switched on again now

[5] Set time/date
[6] Move instrument plate up for cleaning
[7] Automatic ID No. issue: No
[8] Underfilling limit: 05 mm

"Output measuring record" option



A measurement for determination of blood sedimentation values (1h and 2h values) will normally take two hours (we shall ignore the ½ h/1h option for the time being).

### I) Press the [1] numerical key and select "Output measuring record: No".

No output of measuring record via RS 232:

This means that in standard mode, the Sediplus® S 2000 will, after 2 hours have:

- determined the 1h and 2h values
- mathematically converted the measured data to Westergren values
- And provided the values to the user in the list of measurements

The green pilot light at the appurtenant position goes out and the measurement is completed.

Measuring time continues to be counted for checking purposes if the Sedivette® is not immediately removed from the position. The measured data has been determined at the correct times, however!

Once the Sedivette® has been removed, the measured data is stored until the position in the instrument is occupied again.

### II) Press the [1] numerical key and select "Output measuring record: Yes".

The measuring record is to be outputted via the RS 232:

If the "Output measuring record" option is set to "Yes", the instrument should be connected to the computer system or to a serial printer which is ready for operation.

In the case of the Sediplus® S 2000, measurement is only completed in this mode once the measured data for the respective position has been transmitted to the computer system or to the printer.

This signifies that the Sediplus® S 2000 has, after two hours:

- determined the 1h and 2h measured values
- mathematically converted the measured data to Westergren values
- provided the user with the values in the list of ongoing measurements

The instrument will then attempt to output the data via the serial interface to a printer or to the computer system.

- II a) The measuring record can be outputted via the RS 232:

- If this succeeds, measurement is complete.
  - The Westergren values for the measurements continue to be available to the user
  - The green pilot lamp on the appurtenant position goes out
  - The Sedivette® can be removed
  - The measuring time continues to be counted for checking purposes if the Sedivette® is not removed from the position immediately. The measured data have been determined at the correct times, however!
  - Once the Sedivette® has been removed, the measuring record remains stored until the position is occupied again.
- II b) The measuring record cannot be outputted:**
- If the measuring record cannot be transmitted, the measurement is not complete
  - The Westergren values for the measurements are available to the user and can be viewed on the display
  - The green pilot LED on the appurtenant position does not go out
  - Measurement continues (even if the Westergren values have already been correctly determined) until the measuring record can be outputted via the RS 232
  - Removal of the Sedivette® at this point will be detected by the instrument as premature removal of a Sedivette®
  - The instrument issues a corresponding error message and emits a signal tone
  - The measurement is completed as soon as the instrument is able to output the measuring record via the RS 232 (see "II a").

**III) Measuring-record options: [2] Date: Output year: Two-digit or Output year: Four-digit**

Press the figure "1" until you reach the "Measuring-Record Options" menu. The year contained in the date of the records can be outputted in two digits or four digits via the serial interface. Press button "2" in order to select the number of digits for the year:  
This is indicated on the display by the message "Output year 2 (4)-digit for date".

<pre>*** Measuring record options *** [2] Output year with four digits for date [3] For measured value: Output &gt; symbol -&gt; Close using ESC</pre>	<pre>*** Measuring record options *** [2] Output year with two digits for date [3] For measured value: Output &gt; symbol -&gt; Close using ESC</pre>
--	---

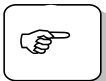

This setting must under all circumstances be taken into account for connection of the instrument to the laboratory or hospital computer system. Consult your system administrator in case of doubt.

**IV) Measuring-record option "Output measured value with ">" symbol"**

Due to the optical measuring principle used, the Sediplus® S 2000 detects the column of blood up to the maximum of the label of the Sedivette®. Sedimentation lengths which are larger than the area scanned cannot be detected by the instrument.

The blood may be able to sediment further behind the label during the measuring period. For this reason, the Sediplus® S 2000 has been expanded with a new function as from Version 1.9.

As from Version 1.9, the instrument detects whether the measuring-range limit is reached or exceeded. The S 2000 indicates this by means of a ">" symbol prefixing the measured value.

The measured value actually determined (zero measurement minus the height of the start of the label) is indicated as the measured value.

The ">" symbol continues to be displayed in all cases for the 2h measured value for plausibility reasons if a measuring-range overshoot is ascertained in the case of the 1h measured value.



In order to keep the measuring record outputted via the RS 232 interface compatible with preceding versions, it is possible to suppress output of the ">" symbol via the serial interface. Selection can be accomplished using the "Measuring-Record Options" menu of the S 2000.



Press button [1] twice in order to access the "Measuring-Record Options" sub-menu of the "Output measuring record" item:

```
[1] Output measuring record: Yes
[2] Measurement at: 1h/2h
[3] Language: English
[4] Reset consecutive ID No.
```

Press button [3] in order to output the measured data with or without the ">" symbol:

```
*** Measuring record options ***
[2] Output year with four digits for date
[3] For measured value: No output > symbol
    -> Close using ESC
```



```
*** Measuring record options ***
[2] Output year with four digits for date
[3] For measured value: No output > symbol
    -> Close using ESC
```

Close the sub-menu by pressing the [ESC] key.



For safety's sake, please check the settings for *Language*, *Underfilling limit*, *Serial interface output Yes/No*, *Reset consecutive ID number or not* and *1h or 2h measurement*.

If necessary, set the values you require again (see Section 2.6.3, "Entry of options").

---

### 2.6.3.2 "Measurement at ½h/1h" option

---

It is possible, using the Sediplus® S 2000, to determine and output the ½h and 1h measured values instead of the 1h and 2h measured values. Operation of the instrument is not altered by this selection. The measured results are displayed as the ½h/1h values, however. The measurement operation for a specimen is completed after one hour if the "½h and 1h" setting is selected.

Press numerical key [2]. The instrument will switch to the "½h/1h" mode. The instrument switches back to the 1h/2h mode when the numerical key [2] is pressed again.

The settings are stored when the instrument is switched off.

---

### 2.6.3.3 "Language" option

---

Like the options described already, "Language", too, can also be altered by pressing the numerical button.

Button [3] can be used to toggle between German and English text output. Reconfiguration to an external PC-AT keyboard with a US character set is installed automatically when English is selected as the language.

---

### 2.6.3.4 "Reset consecutive identification number" option

---

Press button [4] in order to reset the identification number. The current identification number, e.g. "ID: 0000082344, the "The identification number will now be reset" message and → "Press key to confirm" will appear on the display. Press any key to reset the identification number to the initial value 00...1. This procedure can be aborted using [ESC].

### 2.6.3.5 "Set time/date" option



The Sediplus® S 2000 has a built-in electronic clock. This menu makes it possible to set the time, date and day of the week. The date, time and day of the week are default set at the manufacturer's works. Pressing numerical button [5] in the Option menu accesses the menu for entry of the time, day of the week and date:

```
*** Enter time and date ***
Hour: 11 → Value: 0 to 23
```

Use the numerical band to enter the required data and confirm your entry by pressing the [ENTER] in each case. The cursor will then move on to the next box. The following settings are possible:

- Hour                    [ENTER]
- Minute                [ENTER]
- Day                    [ENTER]
- Month                 [ENTER]
- Year                   [ENTER]
- Day of week:        Use [Ident] to select the day of the week and then use [ESC] to close this menu.



It is possible to select between two-digit (04) and four-digit (2004) formats for the **display of the year**.

### 2.6.3.6 "Raise instrument plate for cleaning" function

**Pressing of button [6] raises the instrument plate automatically to permit cleaning of the instrument.** The instrument plate remains in this position for 120 s. The message "S 2000 Cleaning Position" appears on the instrument's display. In addition, the remaining time is counted down in the following message: "The instrument plate will move down again automatically in 120 s". This process can be aborted at any time using [ESC].

### 2.6.3.7 "Automatic issue of consecutive identification number: Yes/No" function



**Consecutive identification number:**

A patient or specimen identification number must be issued for every measurement. This number can be entered in various ways:

- Using the touch-type keyboard on the Sediplus® S 2000
- By means of an optional barcode reader (if purchased)
- By means of a connected PC-AT keyboard (if available)
- In addition to the above possibilities, the instrument can also suggest a consecutive identification number

If the identification number suggested is accepted, the instrument increases it by one automatically at the start of every new measurement.

The "Automatic issue of consecutive identification number" menu item can be found in the Options menu.

This function can be set to "Yes" or "No" using numerical key [7].

With the function set to "No", the identification number can be entered as described in Section 4.4, "Entry of identification number".

If the function is set to "Yes", the next consecutive identification number for the Sedivette® is issued automatically when the Sedivette® is inserted (without previous pressing of the [IDENT] button or reading of a barcode).

### 2.6.3.8 "Underfilling limit 5 to 15 mm" function

The "Underfilling limit 5 mm" menu item can be found in the Options menu.

This option is used to define in millimeters the limit, up to which underfilling in the Sedivettes is not to be detected as an error by the Sediplus® S 2000 (please also see Section 5.2, "Underfilling of the S-Sedivette®"). This limit can be set to values of between 5 and 15 mm.

**Example:**

A value of 8 mm is selected for this option:

- The measurement/the measured data will not be identified as "underfilled" on the result record if the Sedivette® is filled only up to a point 8 mm (or less) below the widening-point in the neck of the Sedivette.
- The measurement/the measured data will be identified as "underfilled" on the result record if the Sedivette® is filled only up to a point 8 mm (or more) below the widening-point of the neck of the Sedivette.
- Assessment of the data obtained from underfilled Sedivettes is at the discretion of the operating staff, the laboratory management or the responsible physician. The reason for this is the differing sedimentation behaviour when Sedivettes are filled to differing extents.
- The Sedivettes are correctly filled provided the plunger is fully extended.
- Ensure when breaking off the plunger that it does not get thrust back into the Sedivette® a short way again.
- The blood level in the Sedivette® should extend up to the start of the widening-point in the neck of the Sedivette®.



Numerous tests have demonstrated that underfilling of up to 5 mm below the widening point of the neck of the Sedivette produces tolerable results.

Any change in the limit is at the discretion of the operating staff, the laboratory management or the responsible doctor. The same applies to the assessment of the measured data obtained using "underfilled" Sedivettes.

Please note when assessing measured data that the maximum measuring length which can be evaluated extends from the meniscus of the column of blood up to the top edge of the label.

The effective measuring range for Sedivettes containing a smaller initial volume is therefore shortened by enlarging the "underfilling limit" (see Section 5.2 "Underfilling of the S-Sedivette®").

**Setting of the required limit:**

Repeated pressing of button [8] increases the limit by one millimeter in each case. The available selection restarts at a value of 5 mm once the 15 mm extreme limit has been reached. The limit selected is displayed to the right of line "[8] Underfilling limit:"

↑	[5]	Set time/date	↑
	[6]	Raise measuring arm for cleaning	
	[7]	Automatic issue of consecutive ID No.: No	
	[8]	Underfilling limit: 5 mm	

## 2.6.4 Description of the serial interface

The Sediplus® S 2000 is equipped with a serial interface for connection of a serial printer or a laboratory computer system.



Only one connection to the laboratory computer system or to the printer is needed, even if work is being performed using multiple expansion modules.

The "Output measuring record" option must be set to "Yes" if you wish to output the measuring records via the serial interface after measurement.

Please see on this subject the detailed description contained in Section 2.6.3.1, "Output measuring record" option.

The complete record of the measurement is outputted via the serial interface as soon as the Sediplus® S 2000 has determined the 1h and 2h (or, optionally, the ½h and 1h) values for blood sedimentation for one position.

If you are using the optional SARSTEDT printer, it must under all circumstances be ensured that the Sediplus® S 2000 is switched on first, followed only then by the serial printer. Communication problems may otherwise occur, with the printer printing only special characters..

### a) Description of interface (important for connection to the laboratory computer system):

The RS 232 C standard, corresponding to DIN 66259, Part 1, applies to the electrical properties of the interface signals and for assignment of signal states.

Character format:		Transmission rate:	Data flow control:
ASCII format		9600 Baud (Bit/s)	Hardware handshake DSR
1	Start bit		
8	Data bits		
None	Parity bit		
1	Stop bit		

Data flow between the Sediplus® S 2000 and the laboratory computer system is controlled by means of hardware handshake. This means that the Sediplus® S 2000 expects at its DSR input (Pin 6: DSR input on 9-pole D-SUB connector of S 2000) the DTR (Data Transmission Ready) signal or the RTS (Request To Send) signal from the laboratory computer system.

Once the corresponding signal is received, data transmission can be controlled from the computer system.

The question of which of the two signals (DTR or RTS) is ultimately used depends on the programming of the computer system and on the cable connection between the S 2000 and the computer system.

### b) Connector (pin) assignment on the Sediplus® S 2000:

9-pole D-SUB connector in accordance with IBM standard

Pin 1 and 2:	not assigned
Pin 3:	TxD (output)
Pin 4:	not assigned
Pin 5:	GND
Pin 6:	DSR (input)
Pin 7 to 9:	not assigned

The Sediplus® S 2000 expects at its DSR input (Pin 6) the DTR (Data Transmission ready) or RTS (Request To Send) signal from the laboratory computer system.

**c) Interface protocol:**

The data for the measuring record is transmitted block-by-block in ASCII code via the RS 232. Every data block consists of a start character, the measuring record and the end character.

- The control character STX (start of text) is transmitted at the start
- The ETX (end of text) character is transmitted at the end
- Every print-line is terminated with a CR/LF.

**Example: (ID Number = 12345 (max. 36 characters); 1h value = 1 mm; 2h value = 10 mm)**

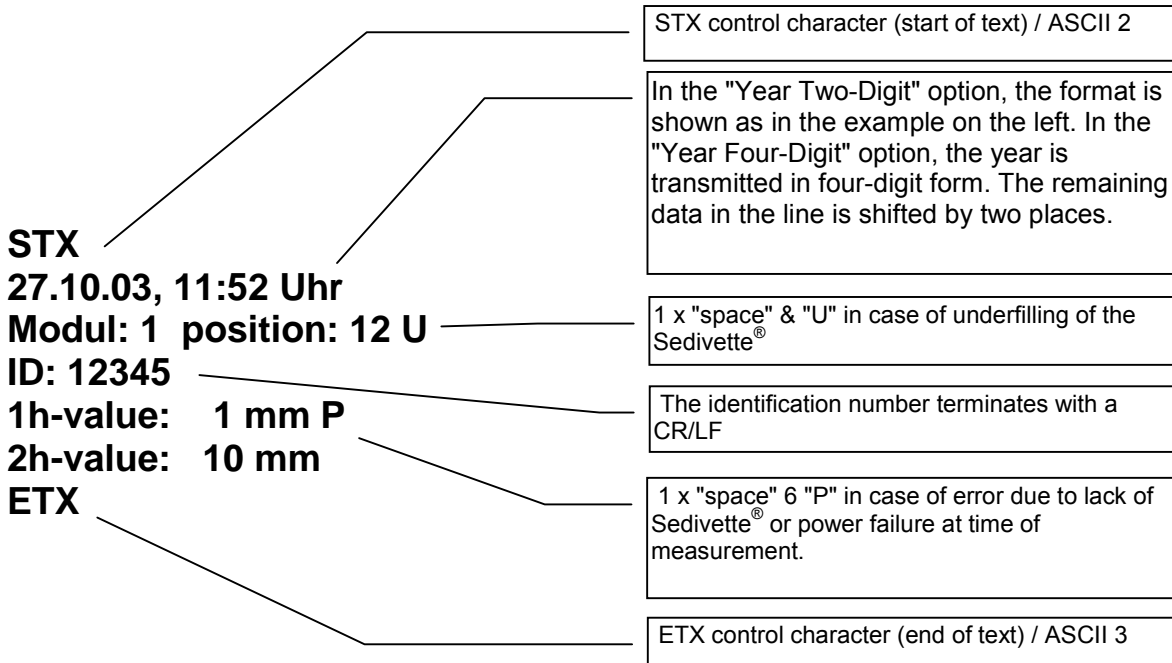

Always use a high-quality interface connector cable featuring the following properties to connect the Sediplus® S 2000 to a printer or to the computer system, in order to meet the requirements of the Electromagnetic Compatibility Directive:

**Screening:** Lead with screening braid. The braid must be applied flatly on the shrouding collar.

**Shrouding:** The connector/socket shrouding must be of solid metal.

**Length:** Use the lead supplied for the printer (or a comparable lead with a maximum length of 1.80 m).

Diagrams of the pin assignments of these leads can be found in the Annex.

### 3 The functional elements of the Sediplus® S 2000



Abbildung 4 Front view of the Sediplus® S 2000

#### 3.1 The instrument plate

The instrument plate features forty guide holes for the Sedivettes, each with a green pilot LED. Each of the forty guide holes, each with a pilot LED, corresponds to a position for performance of a measurement.

The Sedivettes are inserted vertically into the mountings of the basic module via the guide holes. The sensor system for measurement of sedimentation is housed in the instrument plate.

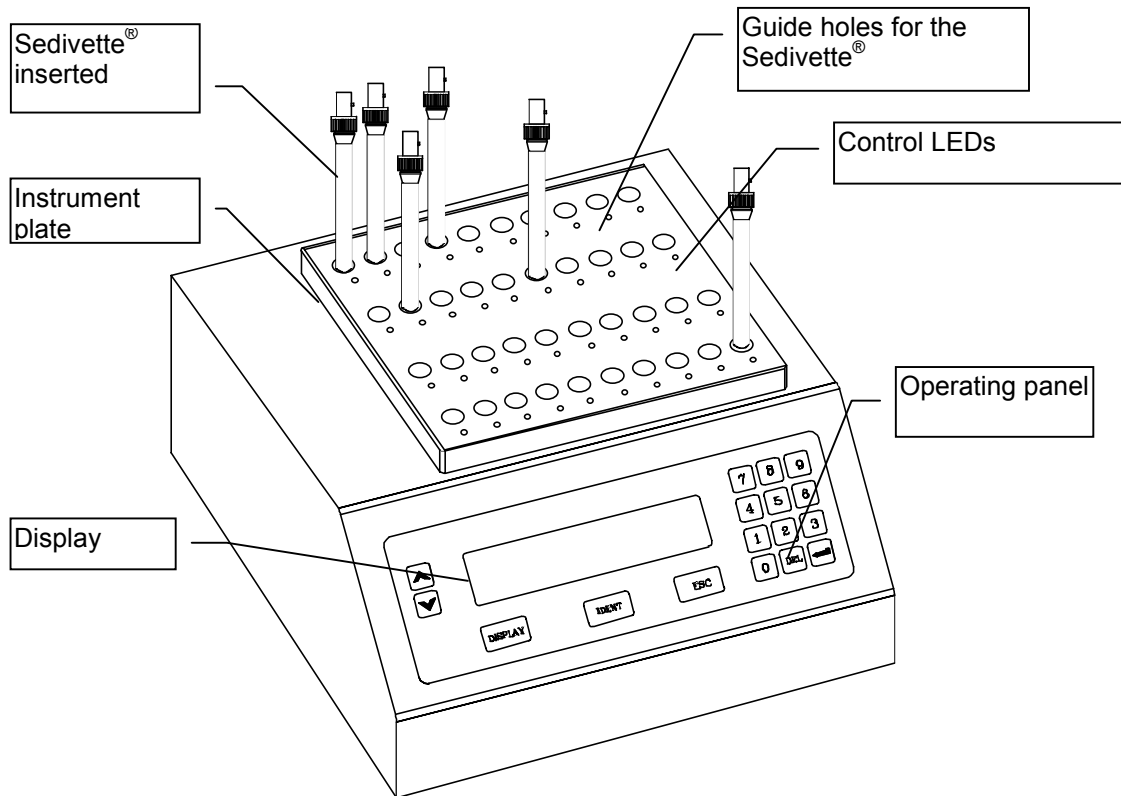
The movement (upward and downward movement during measurement) of the instrument plate must therefore not be obstructed.



**Use only SARSTEDT Sedivette® as the patient's blood carrier for the Sediplus® S 2000.**

**Other tubes, such as Westergren tubes, for example, will produce incorrect blood sedimentation readings.**

### 3.2 The LEDs on the instrument plate



The LEDs indicate the various states of the appurtenant position or of the instrument as a whole.

**All 40 LEDs flash simultaneously.**

Visual signal: The instrument plate will move upward and down again in the next 5 seconds for the purpose of measurement. No Sedivettes may be inserted during this movement period. Wait until the measuring sequence has been completed, then insert the Sedivettes.

**The LED for a specific position is off and the appurtenant position is not occupied.**

This position is vacant. A Sedivette® can be inserted for the purpose of measurement.

**The LED of a position is on. The position is occupied by a Sedivette®.**

Measurement using the Sedivette® inserted has not yet been completed.

The current status of this position can be viewed on the display.

**The LED of an occupied position is off.**

Measurement has been completed. The result can be viewed on the display. The Sedivette® can be removed from the instrument. The measuring position thus becomes vacant for the next measurement.

**The LED for a position is flashing but the position is not occupied.**

The Sedivette® which was in this position has been removed before completion of a measurement.

The following warning message appears on the display:

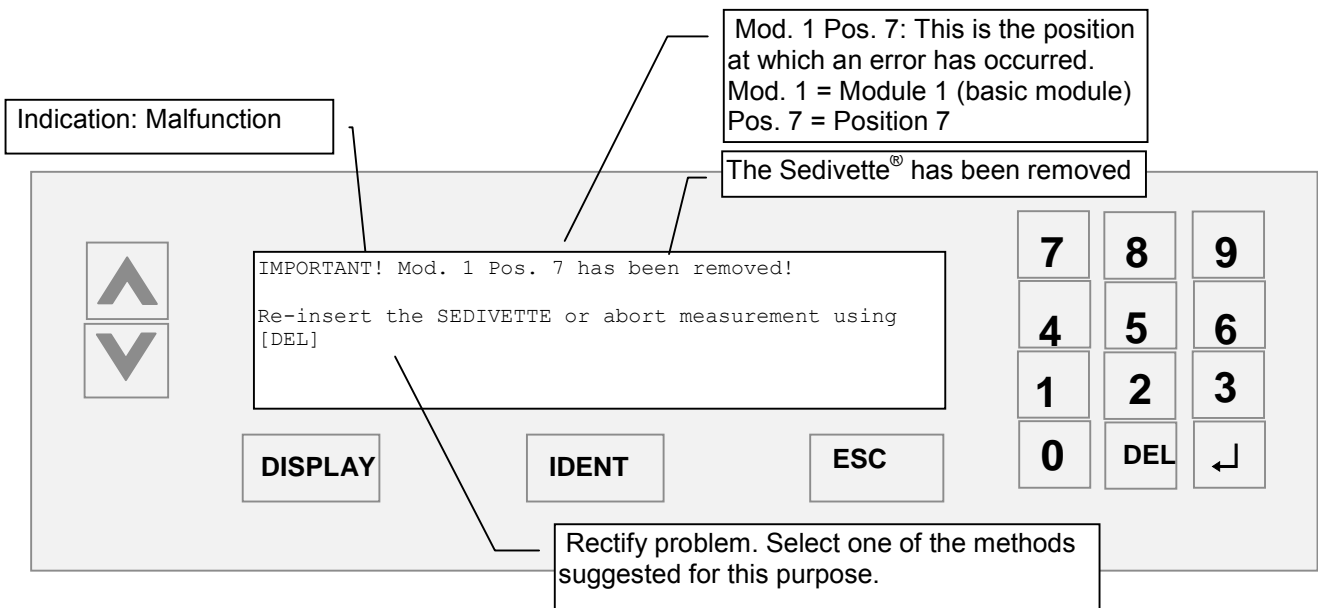

- The position will be in one of the states described above once the error/fault/malfunction has been rectified, using one of the two methods
- If more than one LEDs were flashing previously, check the error message for the next position affected on the display

### 3.3 The display

The display makes it possible to view all measured data for completed and ongoing measurements, using the operating panel. Instrument status (date, day of week, time, number of modules, number of vacant and number of occupied positions and number of measurements completed) is outputted via the display. The following illustration shows the status of the display after switching-on:

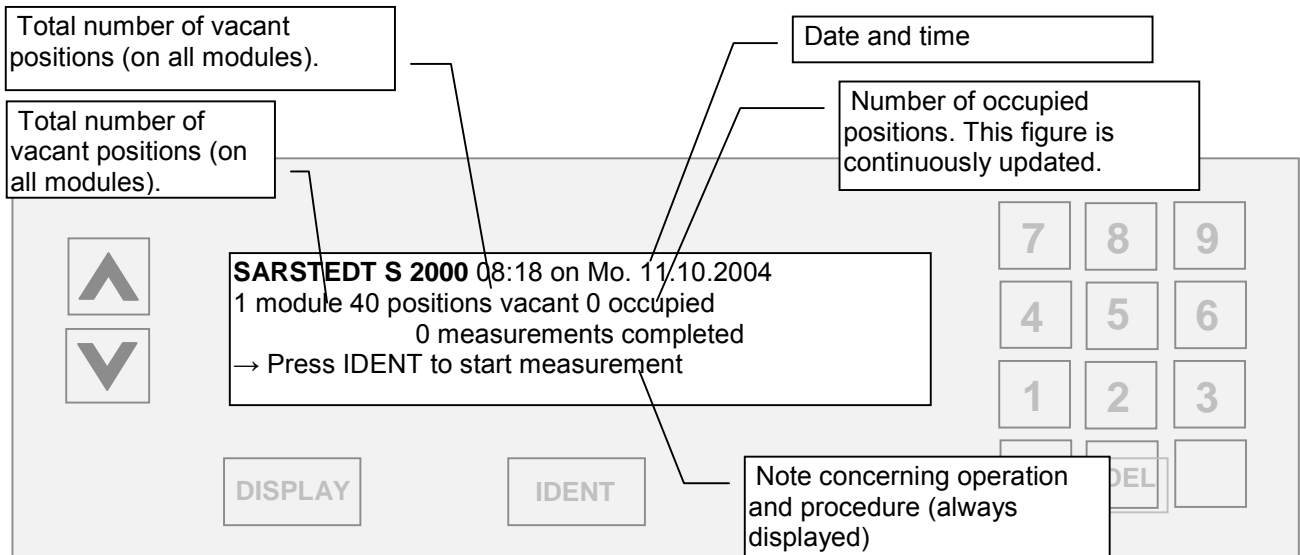

The [DISPLAY] key can be used (provided the corresponding data is present) to toggle between the list of ongoing measurements (or positions from which the Sedivette® has not yet been removed), completed measurements (or positions from which the Sedivette® has been removed) and the status display (condition of the display after switching-on).

The [V] and [^] keys can be used to display the results of various positions.

Use the numerical keys on the operating panel to toggle between the records of various modules if more than one module is in operation.



## 4 Operation of the Sediplus® S 2000

### 4.1 Switching on the instrument

Use the mains switch to activate the Sediplus® S 2000. The following display will appear. This contains the version number of the software in the EPROM.

```
***** SARSTEDT *****  
***** AG & CO. *****  
  
SEDIPLUS S 2000 <====> VERSION X.X
```

The instrument switches onward automatically after a few seconds. The status display will appear. The instrument is then immediately ready for operation.

```
*SARSTEDT S 2000* 08:18 on Mo. 11.10.2004  
1 module 40 positions vacant 0 occupied  
0 measurements completed  
→ Press IDENT to start measurement
```

### 4.2 Preparation of specimens



Please also note the disruptive factors (e.g. paraproteinaemia, lipaemia, haemolysis) described in the medical literature which may have an influence on measurement of blood sedimentation, and check the plausibility of the test result in case of any suspect blood specimens.

- Only use S-Sedivettes for the SARSTEDT Sediplus® S 2000 blood sedimentation system
- The surface of the S-Sedivettes must be clean. There must be no remnants of labels or traces of powder (from gloves) on this surface. Such fouling would cause additional signals which are registered and which could significantly impair determination of sedimentation. The original label and labels applied by users at the same height as the original label do not affect measurement.
- It must in addition be ensured that there are no droplets of blood in the cap and that the cone in the S-Sedivette® is not wetted during insertion. This can occur after taking of a blood sample and/or after mixing. The measurement could be falsified after starting as a result of dripping of blood.

#### **Safety-S-Sedivette® for taking of blood samples**

Use SARSTEDT S-Sedivette® with sodium citrate solution as an anti-coagulant for taking of blood samples.

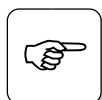

**Please note under all circumstances the notes on use and handling in the SARSTEDT S-Sedivette® pack**

The S-Sedivette® is a sealed blood-sampling system which is used simultaneously as the sedimentation tube. There is no need for decanting of blood or transfer of blood to a separate pipette.



**Important!**

Every blood sample must in every case be mixed thoroughly but without generation of foam immediately after having been taken and immediately prior to insertion into the instrument.

Such mixing can be performed manually, in such a way that the mixing ball contained in the Sedivette® passes through the complete blood specimen or gently and conveniently using a machine specially developed by SARSTEDT AG & Co. for this purpose, the **Sarmix® M 200** (see Section 9, "Information for ordering").

Use the SARSTEDT Sarmix® M 200 for careful and gentle mixing. This mixer makes it possible to mix four S-Sedivettes® simultaneously in eight mixing cycles with alternating high and low mixing speeds.

**Keeping of blood specimens:**

Wherever possible, use the blood specimen obtained immediately. Analysis should be performed within 2 h if the specimen is stored at room temperature.

The blood specimen must not be coagulated.

---

### 4.3 Insertion of the Sedivette® and starting of a measurement

---

The identification number can be entered, the Sedivette® inserted and measurement started in various ways (or in various orders).

The following sequence applies in principle to all types of insertion:

- Measurement starts automatically once the Sedivettes have been inserted.
- All LEDs start flashing 20 seconds after the final Sedivette® has been inserted. No further Sedivettes may now be inserted.
- After a further 5 seconds, the instrument plate scans the newly inserted Sedivette(s)®.
- In this case, scanning of the Sedivettes starts 25 seconds after insertion of the final Sedivette®.

**The Sedivettes inserted will in every case be scanned not later than two minutes after insertion of the final Sedivette®.**

- After scanning, the display will show the status view with information on the number of modules, occupied and vacant positions, and how many measurements have been completed. New Sedivettes can now be inserted and further measurements thus started.

**Method 1:**

**The barcode or patient's identification number is located on the Sedivette®. This must therefore be entered before the Sedivette® is inserted.**

- Press the button [IDENT] on the operating panel (as described on the display). The following display will appear:

```
*** Start sedimentation ***
ID: 0000000001
Please enter an ID number or confirm the
number shown using IDENT
```

- Enter the identification number:

The identification number can be entered via the operating panel or using an optional PC-AT keyboard and confirmed using the [ENTER] key. Another possibility is that of accepting (confirming) the suggested identification number by pressing the [IDENT] key.

- The following display will appear:

```
*** Start sedimentation ***
ID: New Identification Number
Now insert the Sedivette into a vacant
position. (Abort using ESC)
```

- Insert one or more Sedivettes into any vacant positions.

**Method 2:**

**The barcode or patient identification number is only available separately (i.e., not on the Sedivette®).**

- If the patient's identification number is not located on the Sedivette®, the Sedivettes can be inserted into vacant measuring positions without previously pressing a button.
- Measurement starts automatically upon insertion. The following display will appear:

```
IMPORTANT. Mod. 1 Pos. 14 has no ID!
ID: 0000000001
Please enter an ID number of confirm the
suggested number using IDENT
```

**Method 2:**

**The barcode or patient identification number is only available separately (i.e., not on the Sedivette®).**

- If the patient's identification number is not located on the Sedivette®, the Sedivettes can be inserted into vacant measuring positions without previously pressing a button.
- Measurement starts automatically upon insertion.

The following display will appear:

```
*SARSTEDT S 2000 08:18 on Mo, 11.10.2004
1 module 39 positions vacant 1 occupied
0 measurements completed
press IDENT to start measurement
```

**Method 3:**

**Using an optional barcode reader to enter the patient's identification number.**

- Hold the barcode reader up to the barcode for the Sedivette® (on the Sedivette®, for example, or on the patient's record sheet) without previously pressing any button on the control panel and without inserting the Sedivette® into a vacant position.
- If no error is on at this time (as a result of a Sedivette® being removed prematurely, for example), the barcode is automatically recognized and the following message will appear on the display:

```
*** Start sedimentation ***
ID: BARCODE READ
Please now insert the SEDIVETTE into a
vacant position. (Abort
using ESC)
```

- Insert the Sedivette® into any vacant position
- The status display will appear

## 4.4 Entry of the identification number

As described in the previous section, there are various ways of entering the identification number. This can, on the one hand, be accomplished on request using the operating panel, or by means of a barcode reader or a PC keyboard (option).

The Sediplus® S 2000 also makes it possible to issue the same identification number multiple times (**Danger of incorrect identification!**). In such a case, differentiation is possible only on the basis of position, module or time!

- The instrument suggests a consecutive identification number when the [IDENT] button is pressed or when a Sedivette® is inserted.
- This number, if confirmed, is increased by one automatically by the instrument in each case with each succeeding measurement.
- This (suggested) consecutive number can be confirmed as the identification number by pressing the [IDENT] button.
- It is also possible to enter one's **own identification number**.
- For this purpose, use the numerical keys from "1" to "0".
- The suggested identification number can be erased/overtyped by entering the first numeral.
- Further numerals can be entered or the last numeral in each case erased using the [DEL] key.
- Confirm the entry using the [ENTER] key.
- The procedure is analogous if a **keyboard** is used.

### 4.4.1 Entry of the identification number using a barcode reader (optional)

A further method of entering the identification number is that of scanning the number using an optional barcode reader (in many cases, the patient's identification number is present on the Sedivette® or on a patient's record sheet in the form of a barcode).

**Always be sure to hold the Sedivette® vertical** when reading the barcode off from it. Move the barcode on the Sedivette® along the fixed barcode reader (see Section 2.6.2, "Connection of a PC-AT keyboard and/or a barcode reader" or Section 16, "Annex" for information on installation of the optional barcode reader).

Pick up the barcode reader and move it over the barcode on the patient's record sheet.

Please adhere to the following angles and distances when reading off barcodes from the Sedivette® or the patient's record sheet.

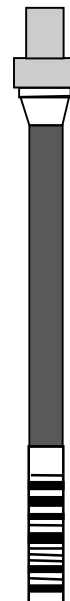

**Always hold the Sedivette® vertical!**

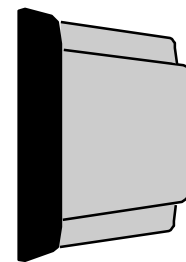

Distance: 0 to 10 mm

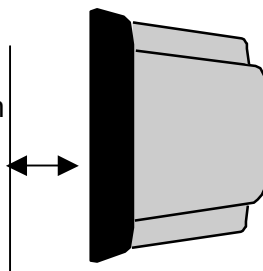

Move the barcode reader over the barcode. Keep it at a distance of 0 to 1 cm.

Maintain a vertical angle of 0 to 10°.

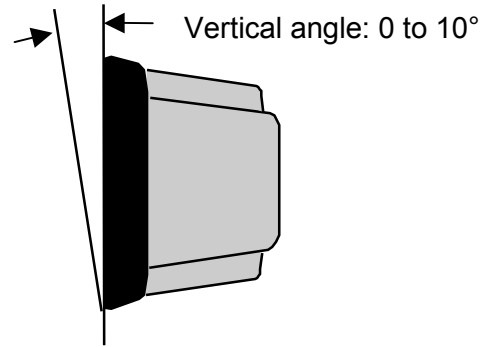

This angle must not be greater than 10° when the barcode reader is tilted forward.

Front angle: max. 10°

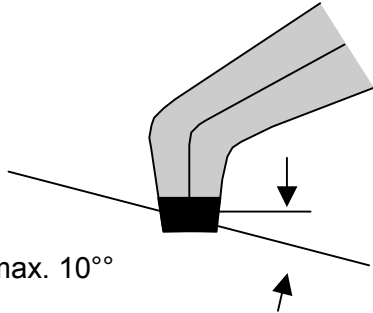

This angle must not be greater than 10° when the barcode reader is tilted backward.

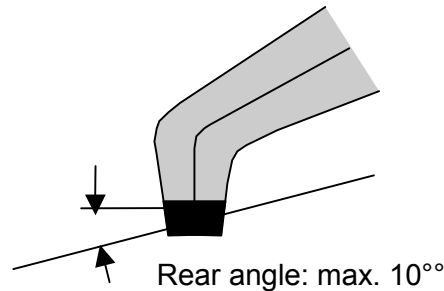

- If the barcode is not read immediately, point the barcode reader in a different direction for a second or two or hold it against a different object (e.g. text on the patient's record sheet). Then try again to read the required barcode.
- If an error or other message is on the display, e.g.:

```
Important! Mod. 1 Pos. 7 has been
removed!

Please replace the SEDIVETTE or abort
measurement using DEL!
```

or:

```
*** Instrument plate has been
obstructed! ***
Please remove the obstruction!
Confirm by pressing key
```



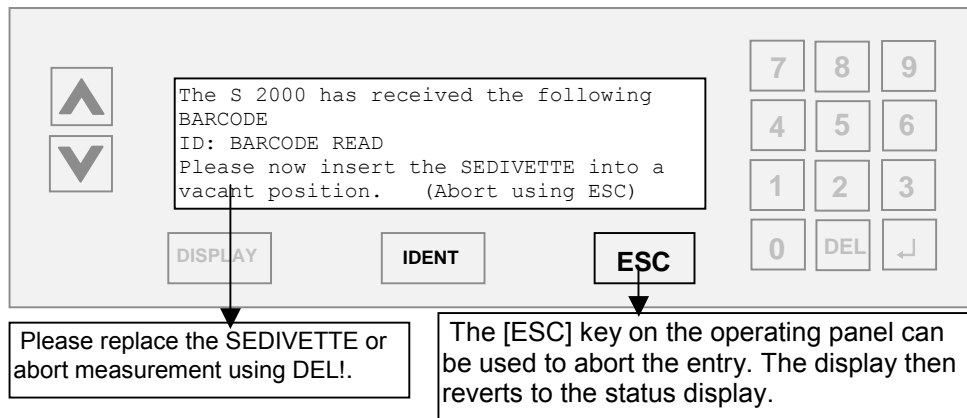

















and an attempt is being made to read a barcode with the barcode reader, the instrument will recognize the barcode but not display it. The cause of the error must firstly be eliminated before the instrument indicates that it has recognized a barcode. It is then possible to start measurement or abort using [ESC].



#### 4.4.2 Entry of the identification number using a PC-AT keyboard (optional)

It is possible to connect a PC-AT keyboard to the 5-pole connecting socket for the barcode reader (please also see Section 2.6.2, "Connection of a PC-AT keyboard and/or a barcode reader"). The PC-AT keyboard can be used in parallel with the operating panel and the barcode reader.

The following table indicates which keys on the Sediplus® S 2000's operating panel (and therefore which functions) correspond to the keys on the PC-AT keyboard:

Keys on the Sediplus® S 2000	Keys on the PC-AT keyboard
	Cursor key (arrow up) 
	Cursor key (arrow down) 
	Cursor keys (arrow right and arrow left)  
	[ENTER] key 
	[ESC] key 
	[ENTER] key 
	"Delete" or "Backspace" key  
 	Numerical keys from [1] to [0]  
The PC-AT keyboard can be used to assign letters for the identification number. This is not possible using the Sediplus® S 2000's operating panel.	The remaining keys can be used for entry of letters and special characters ([SHIFT] & "Character" only) for the identification number. A US keyboard (differing key assignment) can be connected if English is selected as the language.

## 4.5 Viewing of values already determined during a measurement

Determination of measured data for one position is completed after one hour (½h/1h option) or two hours (1h/2h option), depending on the option selected. The two sedimentation values for the position are then available.

It is possible to view the values already determined on the display prior to completion of measurement. Only measured data converted to Westergren values is displayed.

### Example:

The status display is shown during a measurement. It indicates the number of occupied positions and the number of measurements completed from this number.

```
*SARSTEDT S 2000 08:18 on Mo, 18.08.2004
1 module 38 positions vacant 2 occupied
0 measurements completed
Press IDENT to start measurement
```

- A list of the measurements which have not yet been completed appears if the [DISPLAY] button is pressed once.

In the following example, a Sedivette® with identification number 000000002 has been in (M.) Module 1 at (Pos.) Position 9 for 1 hour and 10 minutes. The 1h value of 5 mm is available. No value is available as yet for (Pos.) Position 10 in (M.) Module 1, since measurement has been progressing here only for 5 minutes.

M. Pos.	ID number	1h value	2h value	Time
1 9	000000002	5mm	--	01:10
1 10	000000003	--	--	00:05

- Use the arrow keys [V] and [^] to scroll up and down the display for viewing of other measurements if more than three measurements are being performed.

The numerical keys on the touch-type keyboard can be used to access the records of other modules if further modules are connected to the basic module. Press:

- Key [1] for the records in the basic module
- Key [2] for the records in the first expansion module
- etc..

Switching of the display has no effect on the measuring operation.

- There are in principle two possibilities if the [DISPLAY] key is pressed again:

### a) No measurements as yet completed:

Positions at which a measurement has, however, been completed at an earlier time have already been re-occupied with a Sedivette® (the records of these previous measurements have been erased from the memory).

- In this case, the status display will appear if the [DISPLAY] key is pressed again
- The measured data for completed measurements, the positions of which have been re-allocated, is no longer available
- Continue with measurements

### b) Measurements have been completed:

Positions at which a measurement has been completed have not yet been re-occupied with a Sedivette® (the records of these measurements have not yet been erased from the memory).

- If the [DISPLAY] key is pressed a second time in this case, the measuring records can be viewed, complete with the module, position and identification number of the Sedivettes removed, and the relevant sedimentation values (provided the position in the instrument has not yet been re-occupied).
- The instrument indicates removed Sedivettes on the display as follows:

```
*** Values for removed SEDIVETTES ***
-> Sedimentation values: Module 1/Position 1
ID: 0000000001
1h value: 3mm 2h value 5mm
```

- The arrow keys can be used to access the records for further Sedivettes which have already been removed
- The numerical keys can be used to access the records of Sedivettes which have already been removed from other modules (if any other modules are connected)
- The status display appears if the [DISPLAY] key is pressed again

There are three ways of accessing the measuring record once a measurement has been completed.

**a) Before removing the Sedivette®:**

- It is possible to press the [DISPLAY] key and move to the list of measurements  
The measuring record will be found in this list (provided the Sedivette® has not yet been removed).  
The time figure under "Time" will continue to be counted.
- The same procedure can be selected in order to view the measured data for measurements not yet completed

**b) The display if a Sedivette® has been removed:**

- The instrument switches the display and shows the measuring record for 15 seconds at the moment at which the Sedivette® is removed
- The measuring record will then be erased from the list of measurements
- It is possible to view the result in the "Values for Sedivettes® removed" list, however.

**c) Measuring record after removal of a Sedivette®:**

- Use the [DISPLAY] key to move to the "Values for removed Sedivettes®" list
- Browse the values for the various Sedivettes removed using the arrow keys



**Important!**

When a new Sedivette® is inserted into a position, the measuring record for the Sedivette® previously removed from this position is erased immediately!  
The data is no longer available!

---

## 4.6 Acoustic assistance

---



The Sediplus® S 2000 features acoustic assistance for operation. It is necessary to differentiate between:

- a single tone and
- two short tones in quick succession

The **single tone** is always used as a warning signal, as in the following cases, for example:

- When a Sedivette® has been inserted but the identification number has not yet been entered
- If a Sedivette® is removed before completion of measurement
- If the [DEL] key is pressed and the instrument switched on, in order to erase ongoing measurements
- If the instrument plate has been obstructed during downward movement

The **double tone** indicates confirmation of the identification number entered. This is the case:

- if the [ENTER] key is pressed after the identification number has been entered
- if the consecutive identification number is confirmed using the [IDENT] key
- if a valid barcode has been recognized using the optional barcode reader



## 4.7 Erasure of all data

---



**It is not possible to reverse this function!**  
**Performance of this function will erase all data for both completed and uncompleted measurements.**

- Switch the instrument off
- Press the [DEL] key on the operating panel
- Switch the instrument on, keeping the [DEL] key pressed while doing this
- The instrument will switch to the following display:

**All ongoing measurements to be erased**

**Confirm by pressing key**

- Press the [ESC] key in order to cancel erasure of the ongoing measurements
- Pressing of any other key will result in erasure of the ongoing measurements.  
Any Sedivettes in the instrument will be detected as newly inserted Sedivettes by the Sediplus® S 2000 after the erasure operation.  
The instrument scans the identification numbers of all Sedivettes and starts the measurements.

---

## 4.8 Renewed print-out / Repeat print-out operation

---

If the "Output measuring record: Yes/No" option was set to "Yes" prior to the start of measurements, it is then possible to transfer certain measured data/records to the computer system or to output them again on the serial printer connected.

This applies only to the records for those positions:

- the measurement of which has already been completed (i.e., the Sediplus® S 2000 has determined both sedimentation values for this position and has outputted the appurtenant record via the serial interface)
- and from which the Sedivette® has not yet been removed

Press both arrow keys [V] and [^] simultaneously. All the records for completed measurements will be printed out again provided the appurtenant Sedivettes have not yet been removed. The appurtenant record can no longer be transmitted once the Sedivette® has been removed from its position.

## 5 Malfunctions and operating errors



Please also note the disrupting factors described in medical literature (e.g. paraproteinaemia, lipaemia, and haemolysis), which may have an influence on measurement of blood sedimentation, and check the plausibility of the results obtained in case of suspect blood specimens.

### 5.1 Obstruction of instrument plate's upward and downward movement



The instrument plate must not be obstructed during its upward or downward movement. There must be no objects on or next to the instrument plate. If downward movement is obstructed for any reason, the instrument plate will move up again and remain motionless. The LEDs will flash and the following error message will appear:

```
*** Instrument plate has been  
obstructed!***  
Please remove obstruction.  
. -> Confirm by pressing key
```

Remove the obstructive objects and press any key.

The measuring arm will move to the starting position. Measurement will be repeated after a few seconds.

If the instrument plate is obstructed while moving upward, it will return to the starting position after a few seconds. In this case, there is no message on the display. The obstructed measurement is repeated after 20 seconds.

### 5.2 Underfilling of the S-Sedivette®



The Sedivettes must be correctly filled for measurement of blood sedimentation. It must therefore be ensured as early as the blood-sampling stage that the SARSTEDT Sedivettes are correctly used and handled (see Notes on Use in the Sedivette pack).

- The Sedivettes are correctly filled provided the plunger is fully drawn out and **not** thrust back a distance into the Sedivette® during breaking off of the plunger stem.
- The blood level in the Sedivette® should reach up to the start of the widening-point of the neck of the Sedivette
- In case of underfilling, the operator must decide at his discretion whether the BSR/ESR values are reliable
- The volume of blood in the column in the Sedivette has an effect on the sedimentation value

The instrument detects whether the Sedivette is underfilled at the first measurement. The height from which underfilling is detected as an error and recorded can be specified in the Options menu (Section 2.6.3.8, "Underfilling limit 5 to 15 mm function"). An underfilled Sedivette® is recorded and indicated on the display.

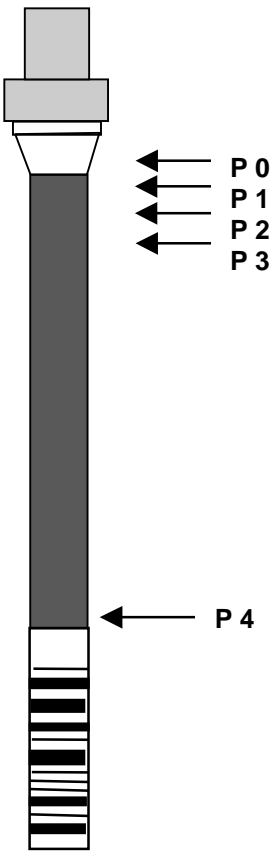

### Sedimentation values as a function of filling height

<b>P 0:</b>	"Cylindrical-to-tapering" transition point, corresponds to filling level at 50 mbar venous pressure
<b>P 1:</b>	<b>5 mm below P 0</b> A Sedivette® filled above this point is not marked with an "U" to indicate "underfilled"
<b>P 2:</b>	<b>10 mm below P 0</b>
<b>P 3:</b>	<b>15 mm below P 0</b> Below this point, a Sedivette® is always marked with a "U" to indicate "underfilled"
<b>Range P 1 to P 3:</b>	Possible setting range for users of the S 2000 software for marking of the Sedivette® with a "U" for "underfilled"
<b>P 4:</b>	<b>Upper edge of label</b> End of usable measuring window

Absolute distances, mm		corresponding to Westergren, mm
P 0 to P 4	70 mm	147 mm
P 1 to P 4	65 mm	116 mm
P 2 to P 4	60 mm	99 mm
P 3 to P 4	55 mm	86 mm

**In the list of ongoing measurements (accessible using the [DISPLAY] key):**

The first measurement is performed a few seconds after insertion of the Sedivette®. The instrument has detected underfilling of the Sedivette® even at this point.

- Pressing of the [DISPLAY] key causes the instrument to display the list of ongoing measurements
- In case of underfilling, a white "U" is displayed on a dark background after the position number. This "U" remains visible throughout the period of the measurement.

M.	Pos	ID-Nummer	1h-Wert	2h-Wert	Dauer
1	15	0000000009	23mm	25mm	02:05
1	16	0000000010	10mm	--	00:30
1	17	0000000011	--	--	00:01

**On a display, if a Sedivette® has been removed after measurement:**

When a Sedivette® is removed after completion of measurement, the sedimentation values for this Sedivette® will appear immediately on the screen.

On this display, too, a white "U" is shown on a dark background (in case of underfilling) after the position number.

Important: This display of the measuring record remains visible only for 15 seconds. The sedimentation values for this position can then be found in the "Values for Sedivettes removed" list.

-> SEDIMENTATION VALUES: Module 1 / Position 10U

ID: 000000015

1h value: 21mm                      2h value: 30mm

Sedimentation time: 2 hours, 5 minutes

**"Values for Sedivettes removed" list:**

The measured data from Sedivettes which have been removed can also be viewed at a later time. This is possible only as long as no new Sedivette® has been inserted into the relevant position. The "Values for Sedivettes removed" list can be accessed using the [DISPLAY] key. Use the arrow keys to leaf through the values for the individual positions in this list. The numerical keys can be used to switch to record lists for other modules (where other modules are installed). In this display, too, a light "U" in a dark box after the position number indicates a case of underfilling.

```
*** Values for SEDIVETTES removed ***
-> SEDIMENTATION VALUES: Module 1 / Position 10U
ID: 0000000015
1h VALUE: 21mm      2h VALUE: 30mm
```

---

**5.3 Incorrect measurement**

---



**Please note:**

A negative value is outputted if the value determined for a measurement is greater than that registered for the zero measurement. The measured value is prefixed with a minus sign.

A negative value can only occur as a result of an incorrect measurement. Check the Sedivette® for correct filling level and for external damage (fouling, scratches, etc.). Then repeat the measurement. Please contact the DESAGA GmbH Service Department at Wiesloch or your local SARSTEDT branch or office if the error persists.

## 5.4 Premature removal of a Sedivette®



Premature removal of a Sedivette® is treated by the instrument as an error. This error occurs if a Sedivette® is removed from its position but the measurement has not yet been completed (please also see Section 4.3, "Insertion of the Sedivette® and starting of measurement").

Cases in which the option "Output measuring record:" has been set to "Yes" but it has not been possible to send any data to the computer system or to a printer are also evaluated as premature removal of a Sedivette®. A warning message is also given in this case.

When the Sedivette® is re-inserted, measurement is continued until the data has been transmitted by the instrument to the computer system.

During this time, the measuring time ("Time" on the display) continues to be counted. It is therefore possible to achieve measuring times with values greater than two hours (the sedimentation values will have been determined at the correct time, however).

The measurement is considered aborted if the [DEL] key is pressed after premature removal of the Sedivette® (as suggested on the instrument's display). The data is then no longer available.

The measuring position is then vacant for a new measurement.

- A warning note is always given on the display if a Sedivette® is removed prior to the completion of the measurement

- New measurements cannot be started until the error has been rectified

- **If required, abort the measurement**

Press the [DEL] key for this purpose. All data in the measuring record (identification number and measured data already determined) will be erased. The position can now be re-allocated.

- **Measurement will be continued if the Sedivette® is re-inserted into the same position**

The instrument treats and documents the error differently, depending on the time at which the Sedivette was removed, and how long it remained removed

- **a) No measurement was being performed in the period for which the Sedivette® was removed**

- Measurement is continued

- Both measured values can be determined at the correct time

- **b) The time for a measurement occurred during the period in which the Sedivette® remained removed. Not more than five minutes elapsed between the time at which the measurement should have occurred and the time at which the Sedivette® was re-inserted.**

- The measurement which has been missed will be performed retrospectively 25 seconds after re-insertion of the Sedivette®

- The measuring delay is less than five minutes and is not taken into account in any other way or documented

- **c) The time for a measurement occurred during the period in which the Sedivette® remained removed. More than five minutes elapsed between the time at which the measurement should have occurred and the time at which the Sedivette® was re-inserted.**

- The measurement which has been missed will be performed retrospectively 25 seconds after re-insertion of the Sedivette®

- The measuring delay was greater than five minutes and is documented as follows:

**Indication on display of incorrectly timed measurement in the list of ongoing measurements:**

- The measurement is performed retrospectively 25 seconds after the re-insertion of the Sedivette®

- As early as this point, the instrument detects incorrectly timed measurement of BSR

- The instrument will display the list of ongoing measurements when the [DISPLAY] key is pressed. In this case, a white "P" is displayed on a dark background after the affected sedimentation values (and before the "mm" data).

M.Pos.	ID number	1h value	2h value	Time
1	10 0000000015	21Pmm	30mm	02:05
1	16 0000000010	--	20Pmm	01:30
1	17 0000000011	--	--	00:01

**Display if a Sedivette® has been removed after measurement:**

- If a Sedivette® is removed after completion of measurement, the sedimentation values for this Sedivette® will appear immediately on the display. A "P" on a dark background is also seen in this display.

**Important!** This record remains visible for 15 seconds only. After this, the sedimentation values for this position can be found in the "Values for Sedivettes removed" list.

```
-> SEDIMENTATION VALUES: Module 1 / Position 10
ID: 0000000015
1h value: 21Pmm          2h value: 30mm
Sedimentation time: 2 hours, 5 minutes
```

**"Values for Sedivettes removed" list:**

- The measured data for the Sedivettes removed can be viewed at a later time. This is possible only as long as no new Sedivette® is inserted in the relevant position.
- The "Values for Sedivettes removed" list can be selected using the [DISPLAY] key
- Leaf through the values for the individual positions in this list using the arrow keys
- The numerical keys can be used to switch to the record lists of other modules (if other modules have been installed)
- A light-coloured "P" in a dark box is also apparent after the sedimentation value (and before the "mm" unit) in this display.

```
*** Values for SEDIVETTES removed ***
-> SEDIMENTATION VALUES: Module 1 / Position 10
ID: 0000000015
1h value: 21Pmm          2h value: 30mm
```



**Please note:**

The Sedivette® can be removed until a measurement is due without the instrument aborting the measurement. This means that removal of the Sedivette® after the zero measurement (for example) and its re-insertion into its position shortly before the 1 hour measurement will result in the instrument performing the overdue measurement retrospectively. The same applies to removal after the 1 hour measurement timely return to the position before the 2 hour measurement. The instrument performs a measurement retrospectively as soon as the relevant Sedivette(s)® has been returned to its position. The fact that measurement was not performed at the correct time is recorded on the measuring record (as from five minutes of exceeded measuring time) but not the duration of the delay, however.

Since sedimentation continues to progress, measurement at a delayed point will result in an excessively high sedimentation value. The user must decide whether a delay is tolerable for diagnosis purposes. Responsible procedure is that of discarding the sedimentation values in case of "late measurement" indicated by the Sediplus® S 2000 and performance of a new sedimentation measurement using a new blood specimen.

**Please note that even slight vibrations of the Sedivette during removal of the specimen between measurements are capable of causing incorrect results.**

## 5.5 Power failures

No error is registered if the instrument is disconnected from the mains supply during a measurement provided no measured-value registration cycle occurs during the period of disconnection from the supply.

The built-in battery ensures that the data already determined remains preserved (stored). This is also the case if the instrument is switched off after completion of all measurements and access to the data is required only on the following day.

The capacity of the built-in battery is not adequate for performance of a measurement if a measured-value registration cycle falls within the period of power failure, however. The instrument performs the overdue measurement(s) retrospectively once the power supply has been restored.

A white "P" on a dark background is positioned between the data for the overdue mm value and the "mm" unit if the time of measurement has been exceeded by more than 5 minutes.

Please see the descriptive problems contained in Section 5.4, "Premature removal of a Sedivette®". Here, the measurement cannot be performed, because the Sedivette® has been removed. The instrument treats both of these incorrect operating actions (errors) identically.



### Example of failure of power supply:

- A measurement has been started. The instrument is disconnected from the mains or switched off a few minutes later.
- The interruption to power supply is noticed after (for example) 2 h and 10 min. and the instrument is switched on again.
- After approx. 20 and 40 seconds, respectively, the instrument retrospectively performs the two missing measurements for the 1 h and 2 h values.

```

->SEDIMENTATION VALUES: Module 1 / Position 10
ID: 0000000015
1h VALUE: 21Pmm      2h VALUE: 21Pmm
Sedimentation time: 2 hours, 30 minutes
    
```

The list of results is outputted on the display as shown above. Identical sedimentation rates have been determined for the 1h and 2h values and displayed as "Pmm".

The same display also occurs if a Sedivette® is removed a few minutes after the start of measurement and re-inserted after the 130th. minute. Both measured values feature a "P" on the record.

## 6 Cleaning the instrument



**Please adhere under all circumstances to the specifications for cleaning of the instrument. Inadequate cleaning and failure to adhere to the specifications may result in malfunctions!**

- Disconnect the instrument from the power supply for the purpose of cleaning
- Exception: The Options menu contains the "Raise instrument plate for cleaning" menu item. This function is used to move the instrument plate upward. It remains up for 120 seconds. The housing elements located underneath the instrument plate can be cleaned during this time. The seconds remaining are indicated on the display. This function can be aborted prematurely using the [ESC] key. In this case, the instrument plate is moved down again immediately.
- Do not spray cleaning agents under the instrument plate
- Use only a slightly moistened cloth to clean the housing elements underneath the instrument plate
- Avoid under all circumstances contact with the PCB on the underside of the instrument plate, contact with the connecting lead and contact with the guide spindles
- Operate the instrument at a voltage of 230 V. No liquid may penetrate into the instrument during cleaning work.
- Always clean the instrument from outside only!
- Clean all accessible housing elements using a slightly moistened cloth. Soap solution may also be used for this purpose. Then carefully dry the instrument.
- Never use scouring agents, aggressive cleaning agents or solvents
- No disinfectant may penetrate into the interior of the instrument. Never use disinfectants in spray canisters.
- Traces of dust or lint can be removed using compressed air
- Never open the instrument in order to remove fouling within the housing
- Have the instrument serviced by the DESAGA service department at regular intervals (please see Section 7, "Service and maintenance").
- The instrument must not be autoclaved



**Blood is a potentially infectious substance; the relevant health and safety regulations and conditions must therefore be adhered to under all circumstances and all equipment cleaned and disinfected correctly.**

Obtain within your Hygiene Department the necessary information concerning the disinfection provisions necessary for your instrument (the instrument can, for example, be sterilized in an ethylene-oxide chamber or cleaned using suitable disinfectants).

Example of a disinfectant:

**The following aqueous solution can be used as a disinfectant:**

25 g ethanol 96 %, 35 g 1-propanol, 0.1 g glyoxal to 100 g aqua dest. Allow this aqueous mixture a number of minutes to act (depending on degree of contamination) and apply the disinfectant solution again if necessary.

Then clean the instrument using a cloth slightly moistened with water and soap. Then dry the instrument carefully.

Also recommendable are Sagrotan med. (disinfectant solution from Reckitt & Colman Sagrotan GmbH) and Bacillol AF from BODE (for medical equipment in the sense of the MPG).



## 7 Service and maintenance

---

Please contact the DESAGA Service department in Wiesloch or your local SARSTEDT sales agency if you have any questions concerning or problems with the instrument. Never attempt to open or repair the instrument yourself.

**Important!** In the majority of service cases, we require the Service Number and EPROM program version for your instrument. The service number can be found on the model plate of your instrument. The EPROM program version is shown on the display immediately after switching-on of the instrument (see Section 4.1, "Switching on the instrument").

Defective instruments are inspected and repaired by our Service Center as rapidly as possible within the framework of our Post-Based Repair Service system. For this purpose, please return the defective instrument together with a description of the problem and the completed contamination questionnaire and a copy of the delivery note, in the original packaging, to the following address or to your local SARSTEDT sales agency:



**DESAGA GmbH / SARSTEDT GROUP**  
Service Department  
In den Ziegelwiesen 1-7

D-69168 Wiesloch  
Germany

Tel.: +49 (0) 62 22 / 92 88 65

Telefax: +49 (0) 62 22 / 92 88 60



**Recommendation:**

Have your instrument serviced by the manufacturer once each year.  
Use SARSTEDT test Sedivettes to check your instrument for correct functioning.  
Have your instrument inspected by the DESAGA GmbH Service Center in case of deviations from the defined sedimentation values.  
(Test Sedivettes for Sediplus® S 2000: 1 set, SARSTEDT No.: 91.189 715)

---

## 8 Decommissioning and disposal

---



**Important notes for disposal:**

Since the Sediplus® S 2000 has been in contact with pathological material in your laboratory, please contact an approved specialist company or your local hazardous-waste disposal company to ensure correct disposal of the instrument and avoid environmental harm.

SARSTEDT S-Sedivettes® and blood specimens used in conjunction with the Sediplus® S 2000 instrument are potential sources of infection. Please always ensure the necessary disinfection and correct disposal!



The spine and cover of this operating manual consist of PVC. The remainder consists of paper and can be recycled after removal of the spine and covers.

## 9 Ordering information

Instrument/Accessories	Order No.:
Sediplus® S 2000, 230 V	90.189 700
Sediplus® S 2000, expansion module	90.189 710
Barcode reader for Sediplus® S 2000, 230 V	90.189 730
Thermo-printer with power pack (230/12 V)	90.189 720
Roll of thermo-paper for printer, 5 items	90.188 055
Sarmix® M 200, 230 V, inc. power pack	90.180 700
S-Sedivette®	06.1690.001
Test Sedivettes for Sediplus® S 2000, 1 set	91.189 716

Other blood sedimentation analyzers available from SARSTEDT AG & Co.:

Article:	Order No.:
SEDIPLUS® S 200, 230 V	90.189 600
SEDIPLUS® S 200, 230 V, with computer/printer interface	90.189 604
SEDIPLUS® S 100, 230 V	90.189 500
SEDIPLUS® S 100, 230 V, with computer/printer interface	90.189 504
BSR Monovette® with membrane seal, with print	05.10 79
BSR Monovette® with membrane seal, with label	05.1079.001
Plastic sedimentation pipette with installed plunger sleeve and safety stopper	86.19 96
Glass sedimentation pipette (0 marking)	95.10 10
Plunger sleeve for glass sedimentation pipette	14.10 57

Please contact SARSTEDT at the following address if you have questions concerning other SARSTEDT products or the SARSTEDT product range:

**SARSTEDT AG & Co.**  
**Postfach 1220**  
**D-51582 Nümbrecht**

**Telefon: +49 (0) 22 93-30 50**  
**Telefax: +49 (0) 22 93-305-122**

oder mit Ihrer lokalen SARSTEDT Verkaufagentur in Verbindung.

## 10 Guarantee and liability



- Our "General Terms and Conditions of Supply and Payment" apply in all cases. These conditions can be found on the reverse of the invoice.
- Any and all guarantee and liability claims shall be deemed excluded if they are the result of one or more of the following causes:
- Improper or incorrect use of the instrument
  - Incorrect installation, commissioning, start-up, operation or maintenance of the instrument
  - Operation of the instrument with defective safety systems/equipment and/or with incorrectly fixed or non-functional safety and protective systems and equipment
  - Failure to adhere to the notes and remarks contained in the operating manual concerning transportation, storage, installation, start-up and commissioning, operation, maintenance and servicing, equipping and disposal
  - Unauthorized modifications to the instrument
  - Disasters resulting from the action of foreign bodies (??????; im deutschen Text steht "Fremdkörpereinwirkung"; Vorschlag: third parties) and/or Force Majeure
  - Incorrectly performed repairs

## 11 Glossary

Anticoagulant	Sodium citrate solution (0.106 mol/l), 0.7 ml pre-metered
Barcode	Patient identification, number on Sedivette® or patient's record sheet
Barcode reader	Scanner for reading of identification numbers
Blood corpuscle sedimentation rate (BSR)	Erythrocyte sedimentation rate in x mm/h
Documentation	Analysis results complete with patient's name and temperature
Expansion module	Expansion of basic module, up to three modules, each with 40 measuring places
Basic module	40 measuring places
Handshake	Communication
Identification number	Instrument-specific distribution of analysis number, number entered at will, or patient barcode
Instrument plate	Guide plate for 40 Sedivettes with built-in sensor system and monitoring LEDs
Measuring record	Results bearing 1/2h values (1/2/1h values), date, time and identification number; output via LCD display, serial printer or via interface to computer system
Measuring points	40 specimen mounting for S-Sedivette®
Room temperature	Temperature range (18 to 23° C as per DIN 58935, Part 1 [1], 18 to 25° C as per NCCLS H2 to A3 [2], 20 ± 3° C as per BS 2554 [3] or as per national or laboratory-specific definition)
RS 232 interface	Serial connecting instrument for data interchange
Sedimentation rate	Rate of descent of erythrocytes in x mm/h
S-Sedivette®	Safety blood-sampling system from SARSTEDT
Westergren	Sedimentation value in mm/h

## 12 Index of illustrations

Abbildung 1 Rear view of the basic module (right) and two expansion modules .....	11
Abbildung 2: The rear panel of the Sediplus® S 2000.....	12
Abbildung 3: Connection of a keyboard and the optional barcode reader to the Sediplus® S 2000 ..	13
Abbildung 4 Front view of the Sediplus® S 2000 .....	22

## 13 References

- 1) Deutsche Norm, Hämatologie, DIN 58935-1, Bestimmung der Erythrozyten-Sedimentationsgeschwindigkeit im Blut Teil 1: Ausgewählte Methode, Dezember 1997.
- 2) Methods for the Erythrocyte Sedimentation Rate (ESR) Test – Third Edition; Approved Standard. NCCLS Document H2-A3, August 1993.
- 3) British Standard Specification for Westergren tubes and support for the measurement of erythrocyte sedimentation rate, BS 2554:1987.

## 14 Index

---

Acoustic assistance 36	Notes on Safety 6
Anticoagulant 47	options 17
barcode reader 14	peripherals 14
blood level 22, 38	pin assignments 24
blood sedimentation 6	plasma 12
Blood sedimentation 8	Power failure 43
cleaning 44	Premature removal 41
Communication 47	RS 232 9
contamination 44	safety regulations 6
disruptive factors 28	serial printer 8, 14
Electromagnetic Compatibility Directive 24	<b>specimen</b> 42
exceeded measuring time 42	Symbols 5
installation 12	system administrator 18
<b>instrument plate</b> 21, 25	transportation damage 11
maintenance 5, 45	Underfilling 17, 22
<b>measuring record</b> 17	Westergren 9, 17, 35, 47

## 15 Contamination Questionnaire

---

Please complete the Contamination Questionnaire (Page 45) before returning the Sediplus® S 2000 instrument to DESAGA GmbH / SARSTEDT GROUP.

Please send the instrument, together with the completed Contamination Questionnaire, a short description of the problem and a copy of the delivery note to:

DESAGA GmbH Service Department / SARSTEDT-GROUP Wiesloch Service Department or to your local SARSTEDT sales agency.

<b>Contamination Questionnaire for repair services</b>	
<p><b>Dear Customer,</b> For safety reasons, we kindly request you to answer the following questions before returning your instrument to DESAGA GmbH / SARSTEDT GROUP Wiesloch for maintenance, repair or surrender.</p>	
Company:	Department:
Town:	Street address:
Name:	Telephone No.:
Instrument/Article:	SN:
<p><b>We hereby confirm that the instrument is <u>not</u> contaminated.</b></p> <p><input type="checkbox"/> <b>The instrument is free of pollutants and other harmful substances and materials</b></p>	
<p><input type="checkbox"/> <b>The instrument has been in contact with the following pollutants and harmful substances:</b></p>	
Substance category	Substance
<input type="checkbox"/> Toxic substances	
<input type="checkbox"/> Corrosive substances	
<input type="checkbox"/> Explosive substances	
<input type="checkbox"/> Radioactive substance	
<input type="checkbox"/> Infectious substances	
<input type="checkbox"/> Inflammatory substances	
<input type="checkbox"/> Other hazardous substances	
<p><input type="checkbox"/> <b>The instrument has been decontaminated in accordance with legal requirements</b></p> <p style="text-align: right;">(☒ please tick as appropriate!)</p>	
Description of decontamination performed:	
Date:	Signature:

---

## 16 Annex

---

---

### 16.1 Initialization of the optional barcode reader

---



The optional SARSTEDT barcode reader is preprogrammed and initialized for the following codes:

- |           |                      |                   |
|-----------|----------------------|-------------------|
| - Code 39 | - UPC-A/UPC-E        | - 2/5 interleaved |
| - Codabar | - MSI                | - Code 128        |
| - Code 11 | - Code 39 Full ASCII | - EAN-8/EAN-11    |

The reason for a barcode reader not detecting the barcode viewed, reading it incorrectly or adding characters (e.g. preceding zeros) is often that a different code is used for the barcode (e.g. transmission of check sums, etc.).

It is often helpful to initialize the barcode reader again.

For this purpose, use the Programming Chart for the barcode reader, which can be found on the following page. This is valid only for optional barcode readers supplied by SARSTEDT!



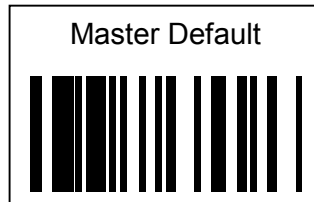

Press the button on the left of the handle to initialize each barcode.

- Connect the barcode reader to the Sediplus® S 2000
- Switch the S 2000 and the barcode reader on
- Perform initialization by moving the barcode reader downward across all codes on the Programming Chart on the following page. The barcode reader emits an acoustic signal for acknowledgement of each barcode recognized.

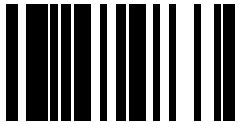

- If this does not solve your problems, the barcode probably has a different code (e.g.: Barcode with check sum, etc.)
- Please note the operating manual for the barcode reader

Barcodereader  
P/N: 3820

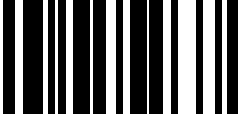
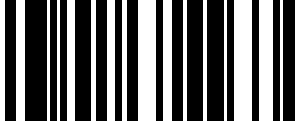
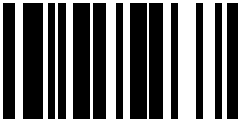
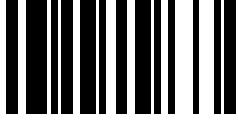
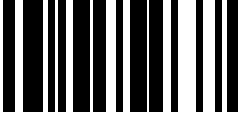
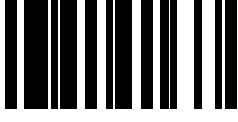
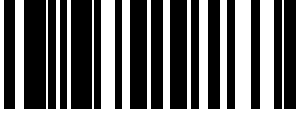
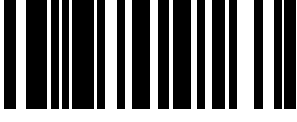
SARSTEDT Default	
	Program
	Operation Mode
	#5
	Buzzer Tone Adjust
	#0
	Preamble
	#0
	#6
	#0
	#D
	Finish
	Exit

## 16.2 Serial connecting cables

### Sediplus® S 2000 / SARSTEDT log printer:

Sediplus S 2000

9-pole socket

SARSTEDT

log printer

DPU 201 GS

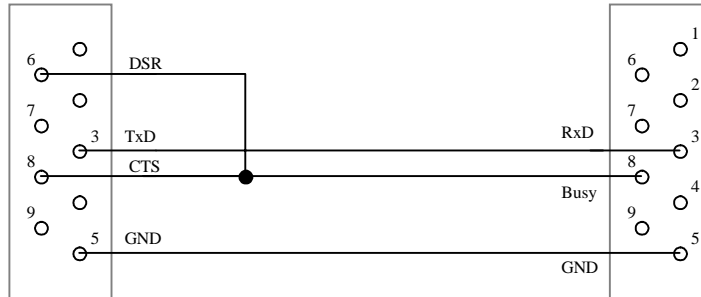

### Sediplus® S 2000 / PC or EDV:

In cases in which the computer system/PC operates using the DTR (Data Transmission Ready) signal:

PC or computer system serial interface

Sediplus S 2000

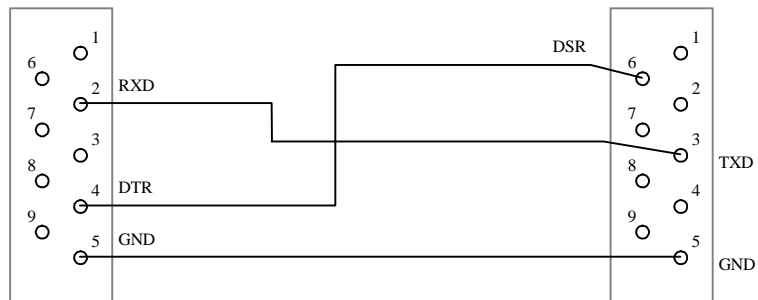

In cases in which the computer system/PC operates using the RTS (Request To Send) signal:

Serielle Schnittstelle des PCs oder der EDV

Sediplus S 2000

