

Register your instrument!
www.eppendorf.com/myeppendorf



Centrifuge 5920 R

Original instructions

Copyright © 2019 Eppendorf AG, Germany. All rights reserved, including graphics and images. No part of this publication may be reproduced without the prior permission of the copyright owner.

Corning® is a registered trademark of Corning Inc., USA.

Microtainer® and Vacutainer® are registered trademarks of Becton Dickinson, USA.

Nalgene® is a registered trademark of Nalge Nunc International Corporation, USA.

TaqMan® is a registered trademark of Roche Molecular Systems, Inc., USA.

Eppendorf® and the Eppendorf Brand Design are registered trademarks of Eppendorf AG, Germany.

Eppendorf QuickLock®, Eppendorf VisioNize® and FastTemp pro® are registered trademarks of Eppendorf AG, Germany.

FastTemp™ is a protected trademark of Eppendorf AG, Germany.

Registered trademarks and protected trademarks are not marked in all cases with ® or ™ in this manual.

U.S. Design Patents are listed on www.eppendorf.com/ip

Table of contents

1	Operating instructions	7
1.1	Using this manual	7
1.2	Danger symbols and danger levels	7
1.2.1	Danger symbols	7
1.2.2	Danger levels	7
1.3	Symbols used	8
1.4	Abbreviations used	8
2	Safety	9
2.1	Intended use	9
2.2	User profile	9
2.3	Information on product liability	9
2.4	Application limits	10
2.4.1	Declaration concerning the ATEX directive (2014/34/EU)	10
2.5	Warnings for intended use	10
2.5.1	Personal injury or damage to device	10
2.5.2	Incorrect handling of the centrifuge	12
2.5.3	Incorrect handling of the rotors	13
2.5.4	Extreme strain on the centrifugation tubes	14
2.6	Safety instructions on the device and accessories	15
3	Product description	17
3.1	Product overview	17
3.2	Delivery package	18
3.3	Features	18
3.4	Name plate	19
4	Installation	21
4.1	Selecting the location	21
4.2	Preparing installation	22
4.3	Installing the instrument	23
5	Operation	25
5.1	Operating controls	25
5.2	Switching on the centrifuge	26
5.3	Initial steps	27
5.3.1	Setting the menu language	27
5.3.2	Setting date and time	27
5.4	Replacing the rotor	27
5.4.1	Inserting the rotor	28
5.4.2	Removing the rotor	28
5.4.3	Triggering rotor detection	28
5.5	Loading a fixed-angle rotor	29
5.5.1	Closing the rotor lid	30
5.5.2	Closing the QuickLock rotor lid	31

Table of contentsCentrifuge 5920 R
English (EN)

5.6	Loading a swing-bucket rotor	31
5.6.1	Inserting the bucket in the swing-bucket rotor.	32
5.6.2	Performing an imbalance calibration	33
5.6.3	Loading buckets symmetrically.	33
5.6.4	Closing the bucket with the cap	36
5.6.5	Mixed equipping with different buckets.	36
5.7	Closing the centrifuge lid	37
5.8	Aerosol-tight centrifugation	38
5.8.1	Aerosol-tight centrifugation in a fixed-angle rotor	39
5.8.2	Aerosol-tight centrifugation in a swing-bucket rotor	39
5.9	Centrifugation	39
5.9.1	Centrifugation with time setting	40
5.9.2	End of centrifugation	40
5.9.3	Centrifuging in continuous operation.	41
5.9.4	Short run centrifugation	41
5.9.5	Setting the radius	42
5.9.6	Setting the acceleration ramp and braking ramp	42
5.9.7	Setting the start of time counting (At set rpm function)	43
5.10	Cooling	43
5.10.1	Setting the temperature	43
5.10.2	Temperature display	43
5.10.3	Temperature monitoring	43
5.10.4	Temperature control run FastTemp.	44
5.10.5	FastTemp pro: automatic temperature control run with programmed start time.	45
5.10.6	Continuous cooling	46
5.10.7	Endless operation of continuous cooling	46
5.11	Switching off the centrifuge	47
6	Device settings	49
6.1	Standby mode	49
6.1.1	Switching on the standby mode	49
6.2	Key lock.	49
6.3	Display.	50
6.3.1	Showing the set value row	50
6.3.2	Setting the contrast.	50
6.4	Speaker	50
6.4.1	Switching the loudspeaker on/off	50
6.4.2	Setting the volume	50
6.5	Calling up device information	50
6.6	Cycle counter	51
6.6.1	Notes on reaching the maximum number of cycles	51
6.6.2	Resetting the number of cycles.	52
6.6.3	Changing the number of cycles	52

7	Programs	53
7.1	Saving the program.....	53
7.1.1	Creating a program.....	53
7.1.2	Quick save with program keys.....	54
7.2	Loading a saved program.....	55
7.2.1	Loading program prog 1 to prog 5.....	55
7.2.2	Loading a program from the program list.....	55
7.2.3	Editing programs.....	56
7.3	Deleting a program.....	56
8	Maintenance	57
8.1	Service.....	57
8.2	Preparing cleaning/disinfection.....	58
8.3	Cleaning/disinfection.....	59
8.3.1	Cleaning and disinfecting the device.....	60
8.3.2	Disinfecting and cleaning the rotor.....	61
8.3.3	Changing the seal of the aerosol-tight cap.....	62
8.4	Additional care instructions for refrigerated centrifuges.....	63
8.5	Cleaning glass breakage.....	63
8.6	Resetting the excess current switch.....	64
8.7	Decontamination before shipment.....	64
9	Troubleshooting	65
9.1	General errors.....	65
9.2	Error messages.....	66
9.3	Emergency release.....	68
10	Transport, storage and disposal	69
10.1	Transport.....	69
10.2	Storage.....	69
10.3	Disposal.....	70
11	Technical data	71
11.1	Power supply.....	71
11.2	Weight/dimensions.....	71
11.3	Noise level.....	72
11.4	Ambient conditions.....	72
11.5	Application parameters.....	72
11.6	Acceleration and deceleration times.....	73
11.7	Service life for accessories.....	74

12 Rotors for the Centrifuge 5920 R	77
12.1 Rotor S-4xUniversal-Large	77
12.1.1 Swing-bucket rotor S-4xUniversal-Large with 4 aerosol-tight buckets	77
12.2 Rotor S-4x1000	83
12.2.1 Swing-bucket rotor S-4x1000 with 4 aerosol-tight round buckets 1000 mL	83
12.2.2 Swing-bucket rotor S-4x1000 with 4 High-Capacity Buckets	87
12.2.3 Swing-bucket rotor S-4x1000 with 4 aerosol-tight plates/tube buckets	91
12.3 Rotor S-4x750	95
12.3.1 Swing-bucket rotor S-4x750 with 4 750 mL round buckets	95
12.3.2 Swing-bucket rotor S-4x750 with 4 plate buckets	99
12.4 Rotor FA-6x50	101
12.5 Rotor FA-20x5	102
12.6 Rotor FA-48x2	104
13 Ordering information	107
13.1 Rotors and accessories	107
13.1.1 Rotor S-4xUniversal Large	107
13.1.2 Rotor S-4x1000	107
13.1.3 Rotor S-4x750	108
13.1.4 Rotor FA-6x50	109
13.1.5 Rotor FA-20x5	109
13.1.6 Rotor FA-48x2	110
13.2 Accessories	110
Certificates	111

1 Operating instructions







1.1 Using this manual

- ▶ Read this operating manual completely before using the device for the first time. Observe the instructions for use of the accessories where applicable.
- ▶ This operating manual is part of the product. Please keep it in a place that is easily accessible.
- ▶ Enclose this operating manual when transferring the device to third parties.
- ▶ The current version of the operating manual for all available languages can be found on our webpage www.eppendorf.com/manuals.

1.2 Danger symbols and danger levels

1.2.1 Danger symbols

The safety instructions in this manual have the following danger symbols and danger levels:

	Biohazard		Explosive substances
	Electric shock		Risk of crushing
	Hazard point		Material damage

1.2.2 Danger levels

DANGER	<i>Will</i> lead to severe injuries or death.
WARNING	<i>May</i> lead to severe injuries or death.
CAUTION	May lead to light to moderate injuries.
NOTICE	May lead to material damage.

Operating instructions

Centrifuge 5920 R
English (EN)

1.3 Symbols used

Depiction	Meaning
1. 2.	Actions in the specified order
▶	Actions without a specified order
•	List
<i>Text</i>	Display or software texts
i	Additional information

1.4 Abbreviations used**MTP**

Microplate

PCR

Polymerase Chain Reaction

rcf

Relative centrifugal force : g -force in m/s^2

rpm

Revolutions per minute

UV

Ultraviolet radiation

2 Safety

2.1 Intended use

The Centrifuge 5920 R is used for the separation of aqueous solutions and suspensions of different densities in approved sample tubes.

The Centrifuge 5920 R is exclusively intended for use indoors. All country-specific safety requirements for operating electrical equipment in the laboratory must be observed.

2.2 User profile

The device and accessories may only be operated by trained and skilled personnel.

Before using the device, read the operating manual carefully and familiarize yourself with the device's mode of operation.

2.3 Information on product liability

In the following cases, the designated protection of the device may be affected. Liability for any resulting damage or personal injury is then transferred to the owner:

- The device is not used in accordance with the operating manual.
- The device is used outside of its intended use.
- The device is used with accessories or consumables that are not recommended by Eppendorf.
- The device is maintained or repaired by persons not authorized by Eppendorf AG.
- The user makes unauthorized changes to the device.

2.4 Application limits

2.4.1 Declaration concerning the ATEX directive (2014/34/EU)



DANGER! Risk of explosion.

- ▶ Do not operate the device in areas where explosive substances are handled.
 - ▶ Do not use this device to process any explosive or highly reactive substances.
 - ▶ Do not use this device to process any substances which may generate an explosive atmosphere.
-

Due to its design and the environmental conditions inside the device, the Centrifuge 5920 R is not suitable for use in a potentially explosive atmosphere.

The device may only be used in a safe environment, such as in the open environment of a ventilated laboratory or a fume hood. The use of substances that may contribute to a potentially explosive atmosphere is not permitted. The final decision on the risks associated with the use of such substances lies with the user.

2.5 Warnings for intended use

2.5.1 Personal injury or damage to device



WARNING! Electric shock due to damage to the device or mains/power cord.

- ▶ Only switch on the device if the device and mains/power cord are undamaged.
- ▶ Only operate devices which have been installed or repaired properly.
- ▶ In case of danger, disconnect the device from the mains/power supply voltage. Disconnect the mains/power plug from the device or the earth/grounded socket. Use the isolating device intended for this purpose (e.g. the emergency switch in the laboratory).



WARNING! Lethal voltages inside the device.

If you touch any parts which are under high voltage you may experience an electric shock. Electric shocks cause injuries to the heart and respiratory paralysis.

- ▶ Ensure that the housing is closed and undamaged.
- ▶ Do not remove the housing.
- ▶ Ensure that no liquids can penetrate the device.

Only authorized service staff may open the device.



WARNING! Danger due to incorrect voltage supply.

- ▶ Only connect the device to voltage sources which correspond with the electrical requirements on the name plate.
- ▶ Only use earth/grounded sockets with a protective earth (PE) conductor.
- ▶ Only use the mains/power cord supplied.



WARNING! Damage to health due to infectious liquids and pathogenic germs.

- ▶ When handling infectious liquids and pathogenic germs, observe the national regulations, the biosafety level of your laboratory, the material safety data sheets, and the manufacturer's application notes.
- ▶ Use aerosol-tight sealing systems for the centrifugation of these substances.
- ▶ When working with pathogenic germs which belong to a higher risk group, more than one aerosol-tight bioseal must be used.
- ▶ Wear your personal protective equipment.
- ▶ For comprehensive regulations about handling germs or biological material of risk group II or higher, please refer to the "Laboratory Biosafety Manual" (source: World Health Organization, Laboratory Biosafety Manual, the current edition).



WARNING! Risk of injury when opening or closing the centrifuge lid.

There is a risk of crushing your fingers when opening or closing the centrifuge lid.

- ▶ Do not reach between the device and centrifuge lid when opening or closing the centrifuge lid.
- ▶ Do not reach into the locking mechanism of the centrifuge lid.
- ▶ Open the centrifuge lid fully to ensure that the centrifuge lid cannot slam shut.



WARNING! Risk of injury from rotating rotor.

If the emergency release of the lid is operated, the rotor may continue to rotate for several minutes.

- ▶ Wait for the rotor to stop before activating the emergency release.
- ▶ To check, look through the monitoring glass in the centrifuge lid.



WARNING! Risk of injury due to defective gas spring(s).

A defective gas spring is an insufficient support for the centrifuge lid. There is a risk of crushing fingers or limbs.

- ▶ Make sure that the centrifuge lid can be opened fully and that it will remain in this position.
- ▶ Regularly check all gas springs for their proper function.
- ▶ Have defective gas springs replaced immediately.
- ▶ Have gas springs replaced by a service technician every 2 years.



WARNING! Risk of injury from chemically or mechanically damaged accessories.

Even minor scratches and cracks can lead to severe internal material damage.

- ▶ Protect all accessory parts from mechanical damage.
- ▶ Inspect the accessories for damage before every use. Replace any damaged accessories.
- ▶ Do not use any accessories which have exceeded their maximum service life.



CAUTION! Poor safety due to incorrect accessories and spare parts.

The use of accessories and spare parts other than those recommended by Eppendorf may impair the safety, functioning and precision of the device. Eppendorf cannot be held liable or accept any liability for damage resulting from the use of accessories and spare parts other than those recommended, or from the improper use of such equipment.

- ▶ Only use accessories and original spare parts recommended by Eppendorf.



NOTICE! Damage to device from spilled liquids.

1. Switch off the device.
2. Disconnect the device from the mains/power supply.
3. Carefully clean the device and the accessories in accordance with the cleaning and disinfection instructions in the operating manual.
4. If a different cleaning and disinfecting method is to be used, contact Eppendorf AG to ensure that the intended method will not damage the device.



NOTICE! Damage to electronic components due to condensation.

Condensate may form in the device when it has been transported from a cool environment to a warmer environment.

- ▶ After installing the device, wait for at least 4 h. Only then connect the device to the mains/power line.



NOTICE! Centrifuge 5920 R: Compressor damage after improper transport.

- ▶ After installation, wait 4 hours before switching on the centrifuge.

2.5.2 Incorrect handling of the centrifuge



NOTICE! Damage from knocking against or moving the device during operation.

If the rotor hits the rotor chamber wall, it will cause considerable damage to the device and rotor.

- ▶ Do not move or knock against the device during operation.
-

2.5.3 Incorrect handling of the rotors



WARNING! Risk of injury from improperly attached rotors and rotor lids.

- ▶ Only centrifuge with the rotor and rotor lid firmly tightened.
- ▶ If unusual noises occur when the centrifuge starts, the rotor or rotor lid may not be properly secured. Immediately press the **start/stop** key to stop centrifuging.



CAUTION! Risk of injury due to asymmetric loading of a rotor.

- ▶ Always load all positions of a swing-bucket rotor with buckets.
- ▶ Load buckets symmetrically with identical tubes or plates.
- ▶ Only load adapters with suitable tubes or plates.
- ▶ Always use tubes or plates of the same type (weight, material/density and volume).
- ▶ Check that loading is symmetrical by balancing the adapters and tubes or plates used with a balance.



CAUTION! Risk of injury from overloaded rotor.

The centrifuge is designed for the centrifugation of material with a maximum density of 1.2 g/mL at maximum speed and filling volume and/or load.

- ▶ Do not exceed the maximum load of the rotor.



CAUTION! Risk of injury due to chemically damaged rotor lids or caps.

Transparent rotor lids or caps made from PC, PP or PEI may lose their strength under the impact of organic solvents (e.g., phenol, chloroform).

- ▶ If rotor lids or caps have come into contact with any organic solvents, they should be cleaned immediately.
- ▶ Check the rotor lids and caps regularly for any damage and cracks.
- ▶ Immediately replace any rotor lids or caps which show cracks or milky stains.



NOTICE! Damage to rotors from aggressive chemicals.

Rotors are high-quality assemblies which can withstand extreme stresses. This stability can be impaired by aggressive chemicals.

- ▶ Avoid using aggressive chemicals such as strong and weak alkalis, strong acids, solutions with mercury ions, copper ions and other heavy metal ions, halogenated hydrocarbons, concentrated saline solutions and phenol.
- ▶ If it is contaminated by aggressive chemicals, clean the rotor and especially the rotor bores immediately using a neutral cleaning agent.
- ▶ Due to the manufacturing process, color variations may occur on PTFE coated rotors. These color variations do not affect the service life or resistance to chemicals.



NOTICE! If handled incorrectly, the rotor may fall.

The swing-bucket rotor may fall if the buckets are used as handles.

- ▶ Remove the buckets before inserting and/or removing a swing-bucket rotor.
- ▶ Always use both hands to carry the rotor cross.



NOTICE! Buckets swinging out in the wrong direction.

If the wrong adapters are used for 500 mL Corning flasks, the buckets of the swing-bucket rotor may swing out in the wrong direction. If the buckets swing out in the wrong direction, this may lead to sample loss or damage to the centrifuge.

- ▶ Therefore, only use the Eppendorf adapters for 500 mL Corning flasks intended for this purpose.

2.5.4 Extreme strain on the centrifugation tubes



CAUTION! Risk of injury from overloaded tubes.

- ▶ Note the loading limits specified by the tube manufacturer.
- ▶ Only use tubes which are approved by the manufacturer for the required g -force (rcf).



NOTICE! Risk from damaged tubes.

Damaged tubes must not be used, as this could cause further damage to the device and the accessories and sample loss.

- ▶ Before use, visually check all of the tubes for damage.



NOTICE! Danger due to deformed or brittle tubes. Autoclaving at excessive temperatures can lead to tubes made from plastic becoming brittle and deformed.

This could cause damage to the device and the accessories and sample loss.

- ▶ Observe the temperatures specified by the manufacturer when autoclaving tubes.
- ▶ Do not use brittle or deformed rechargeable tubes.



NOTICE! Danger from open tube lids.

Open tube lids can break off during centrifugation and damage the rotor and the centrifuge.

- ▶ Carefully seal all tube lids before centrifuging.







NOTICE! Damage to plastic tubes from organic solvents.

The strength of plastic tubes is reduced when organic solvents (e.g., phenol, chloroform) are used, which will damage the tubes.

- ▶ Note the manufacturer's information on the chemical resistance of the tubes.
-

2.6 Safety instructions on the device and accessories

Representation	Meaning	Location
	Notice ▶ Observe the safety instructions in the operating manual.	Right side of the device
	▶ Observe the operating manual.	
	Always tighten the rotor with the enclosed rotor key.	Upper side of the device, under the centrifuge lid.
	Warning: Possible hand injury	Upper side of the device, under the centrifuge lid.
	Warning of biological risks when handling infectious liquids or pathogenic germs.	Aerosol-tight fixed-angle rotors: Rotor lid Aerosol-tight buckets: Cap

3 Product description

3.1 Product overview

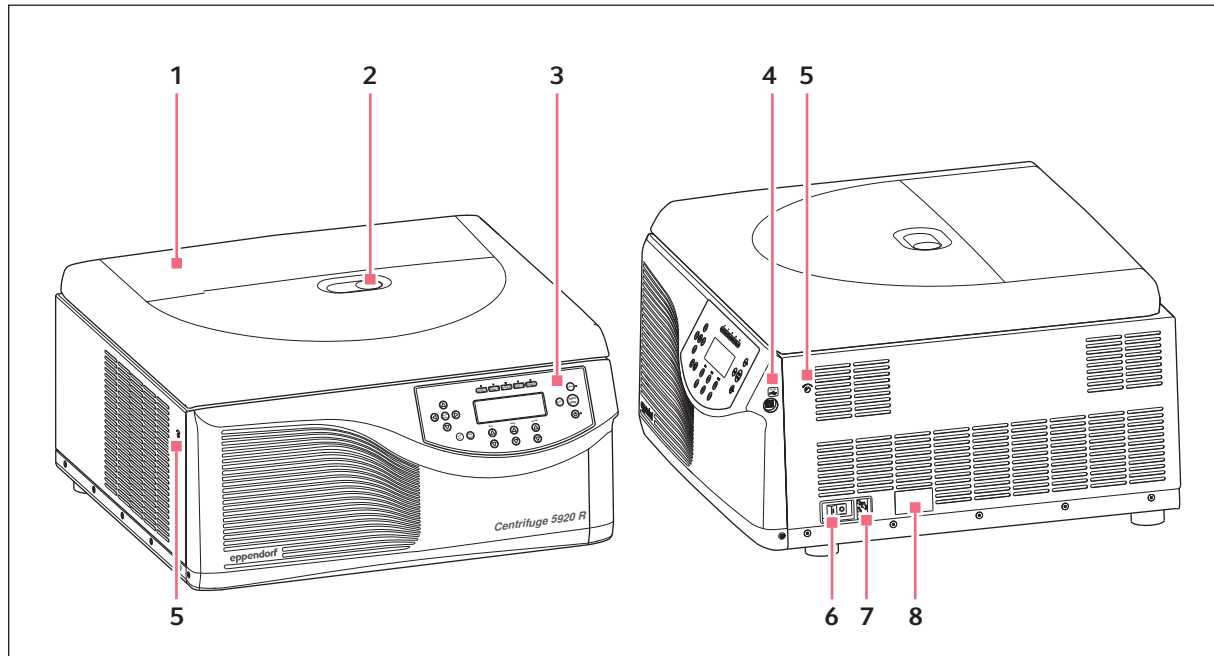

Fig. 3-1: Centrifuge 5920 R: Front and side view

1 Centrifuge lid

2 Monitoring glass

Visual control for rotor stop or speed control option using stroboscope.

3 Control panel

Display and keys for operating the centrifuge.

4 USB interface

Only for Technical Service: Interface for software updates.

5 Emergency release

6 Mains/power switch

Switch for switching the centrifuge on and off.

7 Mains/power cord socket

Connection for the mains/power cord supplied.

8 Name plate

Product description

Centrifuge 5920 R
English (EN)

3.2 Delivery package

1	Centrifuge 5920 R
1	Rotor key
1	Mains/power cord
1	Directions



- ▶ Check whether the delivery is complete.
- ▶ Check all parts for any transport damage.
- ▶ To safely transport and store the device, retain the transport box and packing material.

3.3 Features

The versatile Centrifuge 5920 R has a capacity of 4 × 1000 mL and reaches a maximum of 21 194 × *g* or 13700 rpm. The versatility is reflected in the available rotor options. You can select from 13 different rotors to centrifuge the following tubes for various applications:

- Micro test tubes (0.2 mL to 5.0 mL)
- PCR strips
- Microtainers
- Spin columns
- Cryogenic tubes
- Conical tubes (15 mL, 50 mL)
- Bottles (175 mL to 1 000 mL)
- Various tubes (3 mL to 120 mL)
- Microplates
- PCR plates
- Deepwell plates
- Slides (with CombiSlide adapter)
- Blood collection systems

Handling the centrifuge is facilitated by:

- Automatic rotor detection with rotational speed limit
- Automatic rotor imbalance detection
- Clear digital display

The centrifuge has 99 program slots for user-defined settings and 10 different acceleration and braking ramps.

The possibility of setting the radius manually ensures maximum rcf accuracy.

The Centrifuge 5920 R also features a temperature control function for centrifuging at temperatures from -11 °C to 40 °C. Use the **FastTemp** function to start a temperature control run without samples to bring the rotor chamber incl. rotor, carriers and adapters to the set target temperature quickly. Continuous cooling also maintains the temperature in the rotor chamber with the centrifuge lid closed when the centrifuge is not in use.

The Centrifuge 5920 R can be connected to the Eppendorf VisioNize system. The Eppendorf VisioNize system provides the option to connect the centrifuge to centralized monitoring and data management software. For further information, please refer to the www.eppendorf.com.

3.4 Name plate

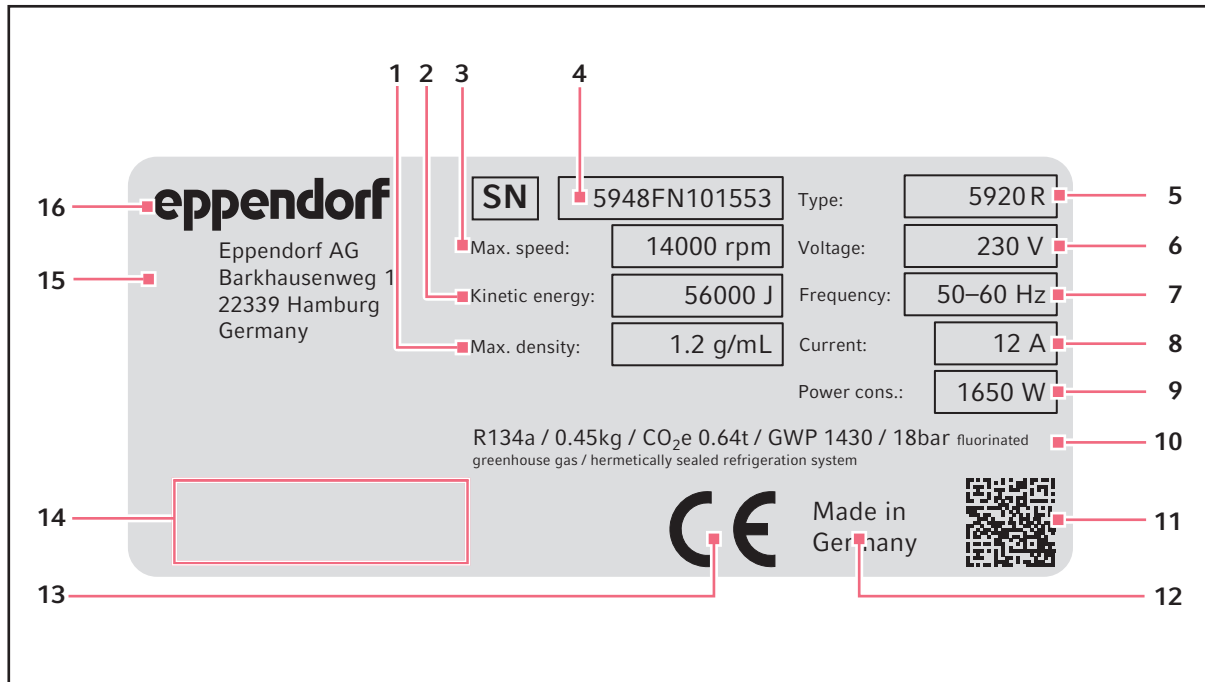

Fig. 3-2: Eppendorf AG device identification (example)

- | | |
|---|--|
| 1 Maximum density of the material for centrifuging | 9 Maximum rated power |
| 2 Maximum kinetic energy | 10 Information on the refrigerant (refrigerated centrifuges only) |
| 3 Maximum speed | 11 Data matrix code for serial number |
| 4 Serial number | 12 Designation of origin |
| 5 Product name | 13 CE marking |
| 6 Rated voltage | 14 Approval marks and symbols (device-specific) |
| 7 Rated frequency | 15 Manufacturer's address |
| 8 Maximum rated current | 16 Manufacturer |

Product description

Centrifuge 5920 R
English (EN)

Tab. 3-1: Approval marks and symbols (device-specific)

Symbol/Approval mark	Meaning
	Serial number
	Symbol for waste electrical and electronic equipment (WEEE) according to EU Directive 2012/19/EU, European Community
	UL listing approval mark: declaration of conformity, USA
	Certification mark for electromagnetic compatibility according to the <i>Federal Communications Commission</i> , USA
	Certification mark for compliance with "China-RoHS" thresholds according to <i>SJ/T 11364 Marking for the restriction of the use of hazardous substances in electrical and electronic products</i> standard, People's Republic of China

4 Installation

4.1 Selecting the location



WARNING! Risk of fire.

Due to the high current consumption of the centrifuge, an overload may occur if the mains/power line is not protected.

- ▶ Only connect the centrifuge to an electric circuit that has its own protection.
 - ▶ Do not connect any devices to the circuit other than the centrifuge.
 - ▶ Only use the mains/power cord supplied.
-



NOTICE! If an error occurs, any objects in the immediate proximity of the device may become damaged.

- ▶ In accordance with the recommendations of EN 61010-2-020, leave a safety clearance of **30 cm** around the device during operation.
- ▶ Please remove all materials and objects from this area.



NOTICE! Damage due to overheating.

- ▶ Do not install the device near heat sources (e.g. heating, drying cabinet).
- ▶ Do not expose the device to direct sunlight.
- ▶ Ensure unobstructed air circulation. Maintain a clearance of at least 30 cm (11.8 in) around all ventilation gaps.



NOTICE! Radio interference.

For devices with Class A noise emission in accordance with EN 61326-1/EN 55011, the following applies: This device has been developed and tested in accordance with CISPR 11 Class A. The device may cause radio interference in domestic environments and is not intended for use in residential areas. The device cannot ensure adequate protection of radio reception in residential areas and domestic environments.

- ▶ If necessary, take appropriate measure to eliminate the interferences.
-



Mains/power connection for centrifuges: The operation of the centrifuge is only permitted in a building installation which complies with the applicable national regulations and standards. In particular, it needs to be ensured that there are no prohibited loads on the supply lines and assemblies that are located before the internal protection of the device. This can be ensured by additional circuit breakers or other suitable fuse elements in the building installation.



The mains/power switch and the disconnecting device of the mains/power line must be easily accessible during operation (e.g. a residual current circuit breaker).

Installation

Centrifuge 5920 R
English (EN)

Select the location of the device according to the following criteria:

- Mains/power connection in accordance with the name plate.
 - Minimum distance to other devices and walls: 30 cm (11.8 in).
 - A resonance-free bench with a horizontal and even work surface which is designed to support the weight of the device.
 - The surrounding area must be well ventilated.
 - The location is protected against direct sunlight.
- ▶ Do not use this device near strong electromagnetic sources (e.g., unshielded high frequency sources) as they could impede proper functioning of the device.

4.2 Preparing installation

The weight of the centrifuge is 139 kg (306.44 lb).



CAUTION! Risk of injury when lifting and carrying heavy loads

- ▶ Use a lifting aid for the installation of the device.
-

Unpacking the centrifuge

1. Open the packaging board.
2. Remove accessories.
3. Remove the transport securing devices.
4. Remove the plastic sleeve.
5. Lift the centrifuge out of the cardboard box by means of a suitable mechanical lifting aid.
6. Place the device on a suitable lab bench.

4.3 Installing the instrument

Prerequisites

The device is on a suitable lab bench.



WARNING! Danger due to incorrect voltage supply.

- ▶ Only connect the device to voltage sources which correspond with the electrical requirements on the name plate.
- ▶ Only use earth/grounded sockets with a protective earth (PE) conductor.
- ▶ Only use the mains/power cord supplied.



NOTICE! Damage to electronic components due to condensation.

Condensate may form in the device when it has been transported from a cool environment to a warmer environment.

- ▶ After installing the device, wait for at least 4 h. Only then connect the device to the mains/power line.



NOTICE! Compressor damage after improper transport.

- ▶ After installation, wait 4 hh before switching on the centrifuge.
-

1. Let the device warm up to ambient temperature.
2. Connect the centrifuge to the mains/power line and switch it on at the mains/power switch.
 - The LED next to the **Standby** Ⓢ key lights up.
 - The display is active.
3. Open the centrifuge lid with the **open** key.

5 Operation

5.1 Operating controls

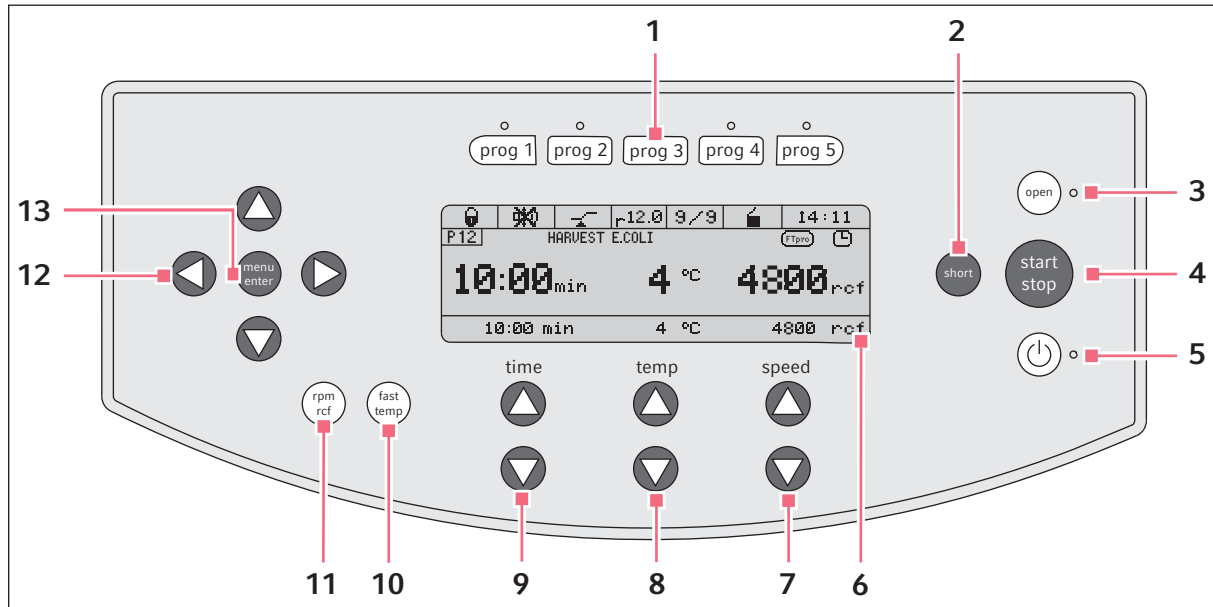



Fig. 5-1: Operating controls Centrifuge 5920 R

- | | |
|--|--|
| <p>1 Program keys
Press the program key: Load program
Keep the program key pressed for 2 s: Save current parameters</p> <p>2 short key
Short spin centrifugation</p> <p>3 open key
Release lid</p> <p>4 start/stop key
Start and stop centrifugation</p> <p>5 Standby  key
Activate/deactivate standby mode
LED lights up green: centrifuge is ready for operation.
LED lights up red: standby mode is active.</p> <p>6 Display</p> <p>7 speed arrow keys
Set centrifugation speed
Keep the arrow key pressed: Quick setting</p> | <p>8 temp arrow keys
Setting the temperature
Keep the arrow key pressed: Quick setting</p> <p>9 time arrow keys
Set centrifugation time
Keep the arrow key pressed: Quick setting</p> <p>10 fast temp key
Start FastTemp temperature control run</p> <p>11 rpm/rcf key
Switch display of centrifugation speed (rpm or rcf)</p> <p>12 Menu arrow keys
Navigate the menu</p> <p>13 menu/enter key
Open menu
Confirm your selection</p> |
|--|--|

Operation

Centrifuge 5920 R
English (EN)

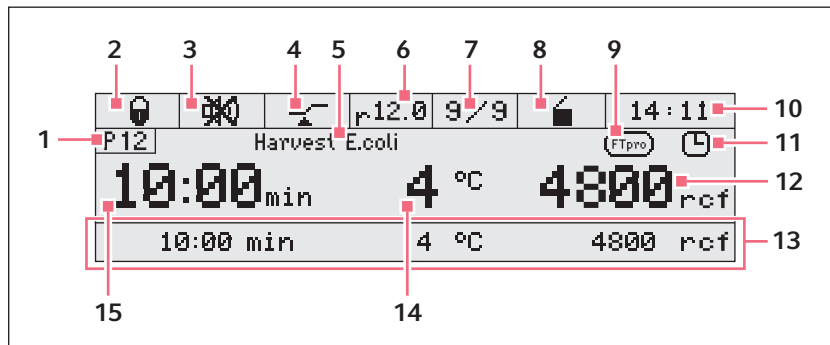

Fig. 5-2: Display Centrifuge 5920 R

1 Program number

2 Key lock

- ☰ Key lock activated: Parameters cannot be changed.
- ☶ No key lock.

3 Speaker

- 🔊 Speaker switched on.
- 🔇 Speaker switched off.

4 At set rpm function

- 📈: the set run time will be counted down when 95 % of the specified *g*-force (rcf) or speed (rpm) has been reached.
- 📈: time counting begins immediately.

5 Program name

6 Radius

7 Ramps

Accelerating and braking of the rotor.

8 Status of centrifuge

- 🔒 centrifuge lid unlocked.
- 🔒 centrifuge lid locked.
- 🔄 (flashing): centrifuging in progress.

9 FastTemp pro

🔥 FastTemp pro has been enabled. The start time and the temperature of the temperature control run are programmed.

10 Time

11 Timer

🕒 Timer set: delayed start (in programs only).

12 *g*-force (rcf) or speed (rpm)

Actual value

13 Set value row

Set values for centrifugation time, temperature, centrifugation speed. Visible, if *Extended display* has been enabled in the settings.

14 Temperature

Actual value

15 Centrifugation time

Actual value

5.2 Switching on the centrifuge

1. Switch on the centrifuge using the mains power switch or the **Standby** Ⓞ key.
The parameter settings of the last run are displayed.
2. Press the **open** key to open the closed centrifuge lid.

5.3 Initial steps

5.3.1 Setting the menu language

1. Open menu: press the **menu/enter** key.
2. Use the menu arrow keys to select *Settings*. Confirm with the **menu/enter** key.
3. Use the menu arrow keys to select *Language*. Confirm with the **menu/enter** key.
4. Use the menu arrow keys to select *Deutsch, Francais, English* or *Espanol*. Confirm with the **menu/enter** key.
A checkmark appears in front of the selected language. The setting takes effect immediately.
5. To exit the menu, press the left menu arrow key ◀ several times.

5.3.2 Setting date and time

1. Open menu: press the **menu/enter** key.
2. Use the menu arrow keys to select *Settings*. Confirm with the **menu/enter** key.
3. Use the menu arrow keys to select *Date/Time*. Confirm with the **menu/enter** key.
4. Use the menu arrow keys to select *International Time* or *US-Time (AM/PM)*. Confirm with the **menu/enter** key.
5. Set the date and time with the menu arrow keys. Confirm with the **menu/enter** key.
6. To exit the menu, press the left menu arrow key ◀ several times.



The time does not change automatically from summer time to winter time.

5.4 Replacing the rotor



NOTICE! If handled incorrectly, the rotor may fall.

The swing-bucket rotor may fall if the buckets are used as handles.

- ▶ Remove the buckets before inserting and/or removing a swing-bucket rotor.
- ▶ Always use both hands to carry the rotor cross.



NOTICE! Risk of material damage due to improper rotor insertion.

The motor shaft or bearing may become damaged if the rotor falls into the motor shaft guides in an uncontrolled manner when it is inserted.

- ▶ Hold the rotor with both hands.
- ▶ Guide the rotor onto the motor shaft.

5.4.1 Inserting the rotor

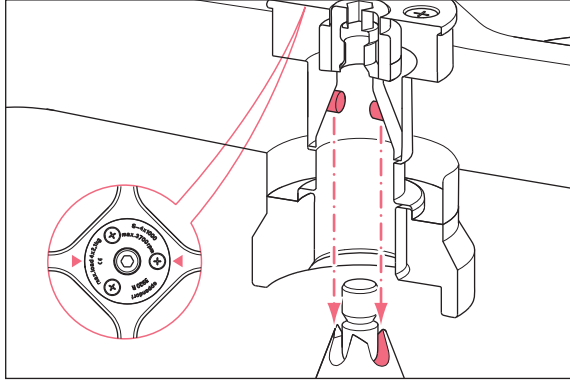

1. Place the rotor vertically onto the motor shaft from the top.
The arrows on the rotor show the position of the pegs. The pegs of the rotor must fit into the motor shaft guides. If required, lift the rotor and place it onto the motor shaft again.
2. Insert the rotor key supplied into the rotor nut.
3. Turn rotor key **clockwise** until the rotor nut is firmly tightened.

5.4.2 Removing the rotor

1. Turn the rotor nut **counterclockwise** using the rotor key supplied.
2. Remove rotor by lifting it vertically.

5.4.3 Triggering rotor detection



CAUTION! Risk of injury when turning the rotor manually.

- ▶ When turning a swing-bucket rotor, pay special attention to ensure that your fingers do not get jammed or get caught on the swinging buckets.

The centrifuge detects a newly inserted rotor if the rotor is moved at low speed.

- ▶ In order to trigger rotor detection manually, turn the rotor **counterclockwise** by hand.
 - The name of the rotor appears in the display.
 - If the g -force (rcf) or speed (rpm) has been set higher, it will be limited to the maximum value of the rotor.



Triggering rotor detection using short-spin centrifugation

- ▶ Press and hold the **short** key until the name of the rotor appears on the display.

If you start centrifuging immediately after a rotor change, then the centrifuge has not yet detected the new rotor. If the set *g*-force/speed is higher than the maximum permitted *g*-force/speed of the new rotor, the following message appears in the display:

```
rpm/rcf too high!  
[START] Centrifugation at ### rpm/### rcf  
◀ ▶ Change parameters.
```

- The message shows the maximum permitted *g*-force/speed of the new rotor.
 - The rotor is not stopped, but it is held at a speed of 700 rpm.
 - You have 15 seconds to adopt the *g*-force/speed or to change it.
- ▶ Adopt the displayed *g*-force/speed for the run: Press the **start/stop** key.
 - ▶ To change the *g*-force or speed for the run: use the arrow keys **speed** to set a different value.

If you do not adopt or change the *g*-force/speed within 15 s, the centrifuge will stop running. The display shows the error message *Hint C*.



- ▶ After each rotor change, check whether the new rotor is detected by the device.
- ▶ Check the set *g*-force (rcf) and/or speed (rpm) and adjust it, if required.

5.5 Loading a fixed-angle rotor



CAUTION! Risk of injury due to asymmetric loading of a rotor.

- ▶ Load rotors symmetrically with identical tubes.
- ▶ Only load adapters with suitable tubes.
- ▶ Always use the same type of tubes (weight, material/density and volume).
- ▶ Check that loading is symmetrical by balancing the adapters and tubes used with a balance.

1. Check the maximum payload (adapter, tube and contents) for each rotor bore.
2. Load rotors and adapters only with the tubes intended for them.
3. To ensure symmetrical loading, insert sets of two tubes in opposite bores. Tubes located opposite each other must be of the same type and contain the same filling quantity.

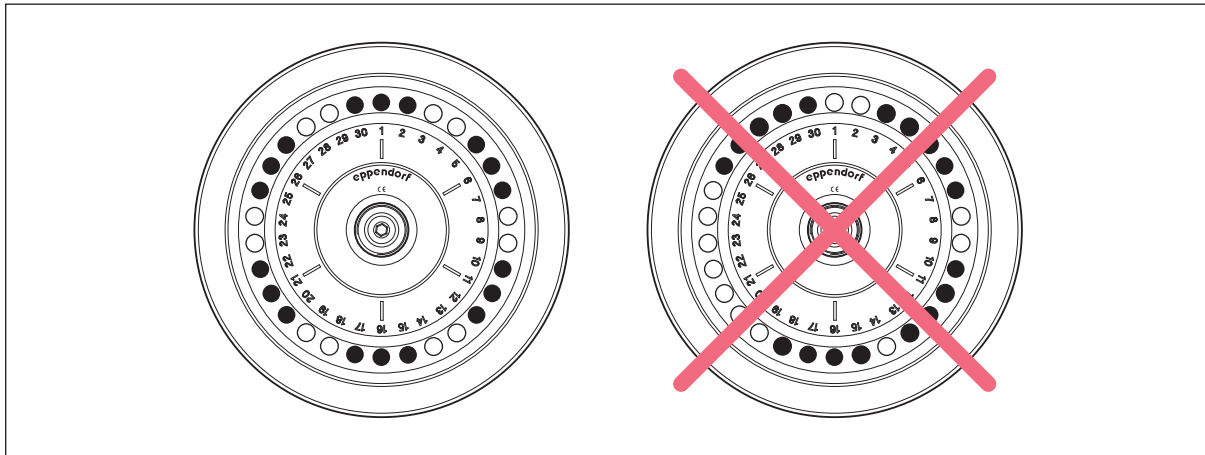

Fig. 5-3: Symmetrical loading of a fixed-angle rotor

To keep the weight differences between the filled tubes low, we recommend taring with a balance. This will reduce wear on the drive and reduce operating noise.

5.5.1 Closing the rotor lid



Use matching rotor lids

- Fixed-angle rotors may only be operated with the appropriate rotor lid in each case. The rotor name on the rotor must correspond to the rotor name on the rotor lid.
- To carry out an aerosol-tight centrifugation, an aerosol-tight rotor (label: **red ring**) and the corresponding aerosol-tight rotor lid (label: **aerosol-tight** and **red lid screw**) must be used.

1. Fit the rotor lid vertically onto the rotor.
2. Turn the rotor lid screw clockwise to seal the rotor.

5.5.2 Closing the QuickLock rotor lid

Aerosol-tight rotors have a QuickLock rotor lid.

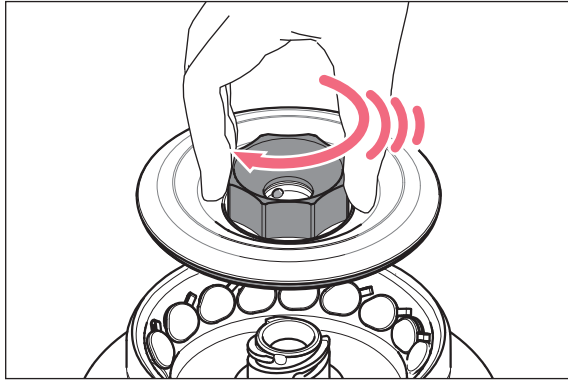

1. Check the correct positioning of the external sealing ring in the groove.
2. Place the rotor lid on the rotor in a vertical motion.
3. To lock the rotor, turn the red rotor lid screw clockwise as far as it will go, and after an audible "click" is heard.



The rotor is correctly locked after the audible "click" is heard!

5.6 Loading a swing-bucket rotor



CAUTION! Risk of injury due to asymmetric loading of a rotor.

- ▶ Always load all positions of a swing-bucket rotor with buckets.
- ▶ Load buckets symmetrically with identical tubes or plates.
- ▶ Only load adapters with suitable tubes or plates.
- ▶ Always use tubes or plates of the same type (weight, material/density and volume).
- ▶ Check that loading is symmetrical by balancing the adapters and tubes or plates used with a balance.



NOTICE! Material damage due to incorrect equipping of the swing-bucket rotor.

Incomplete equipping of the swing-bucket rotor or an uneven load will reduce the service life of the rotor and the corresponding buckets considerably.

- ▶ Always load all positions of a swing-bucket rotor with buckets.
- ▶ Load opposite buckets with the same weight (adapter, tubes, or plates and content).

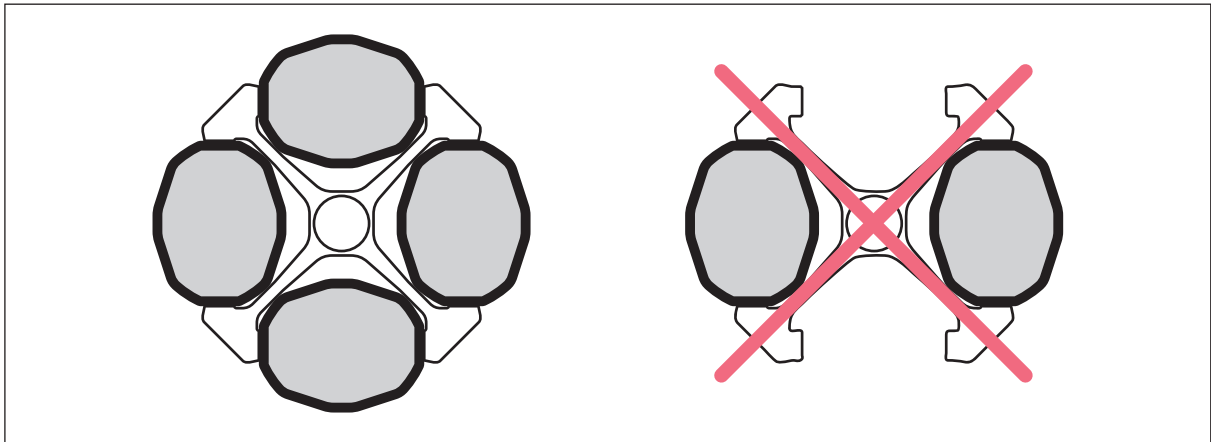

Fig. 5-4: Swing-bucket rotors: Loading all positions with buckets

5.6.1 Inserting the bucket in the swing-bucket rotor

Prerequisites

- The combination of rotor, bucket and adapter has been approved by Eppendorf.
- Buckets that are located opposite each other belong to the same weight class. The weight class is engraved in the sides of the groove: e.g., 68.
- Matching and tested tubes and plates.



The swing-bucket rotor runs more smoothly if all buckets are loaded symmetrically and with the same weight.

- ▶ To reduce noise and vibrations, load the buckets of the swing-bucket rotor with the same weight.

1. Check that the bucket grooves are clean. Use pivot grease to lightly lubricate the grooves.
2. Hang the buckets into the rotor.
All rotor positions must be equipped with buckets.
3. Check to see if all buckets are completely hung and can freely swing out.
4. Check the maximum load per bucket (adapter, vessel or plate and contents) and the loading height.
5. Load the buckets symmetrically.



- ▶ When using a vessel type or plate type for the first time, carry out a brief test run at low speed (e.g., 1000 rpm).

5.6.2 Performing an imbalance calibration

Carry out a manual imbalance calibration when you use a tube or plate for the first time. Always carry out a manual imbalance calibration when you use tubes with a length of > 100 mm.

- ▶ Inserting plates and/or tubes.
- ▶ Swing the buckets manually up to 90°.
 - Bucket swings freely.
 - The tubes do not touch the rotor cross.

5.6.3 Loading buckets symmetrically

5.6.3.1 Equipping buckets with vessels

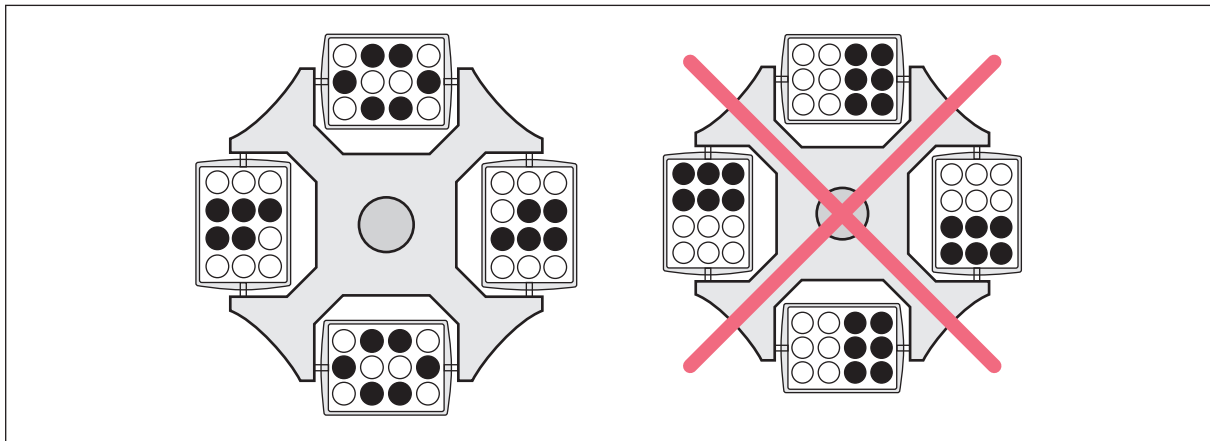

Fig. 5-5: Swing-bucket rotors: Incomplete, but symmetric loading of the buckets.

The loading shown on the right-hand side is incorrect as it places an uneven load on the pegs of the rotor.

- ▶ To reduce vibrations and noise, load all buckets of the swing-buckets rotor equally.

5.6.3.2 Loading plates symmetrically



NOTICE! Filling the plates too high can cause overflowing.

During the run the menisci in the tubes along the edges of the plates are at an angle. This is due to the centrifugal forces and cannot be avoided.

- ▶ Fill the plate wells to a maximum of $2/3$ of the maximum filling volume.

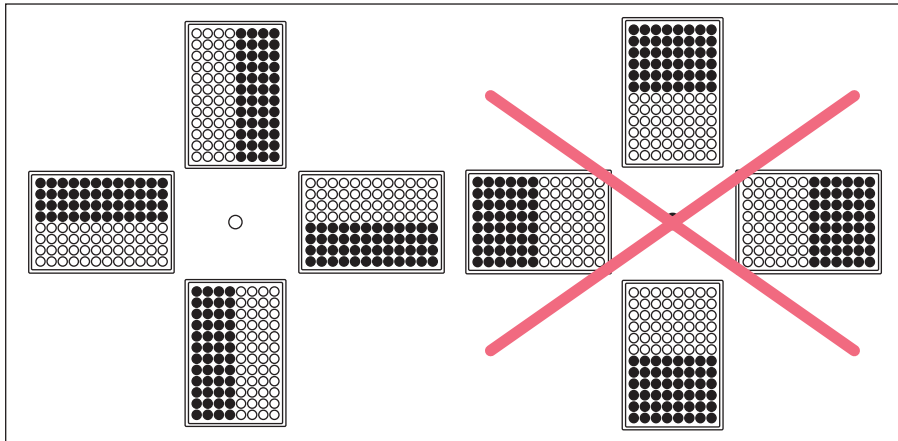

Fig. 5-6: Swing-bucket rotors: Symmetrical loading of plates

- ▶ In order to avoid imbalances, always load the plates symmetrically.

The plate loading shown on the right-hand side is incorrect as the plate buckets will not swing properly if loaded in this way.

5.6.3.3 Rotor S-4x750: Equipping the adapter with vessels > 119 mm



NOTICE! Broken glass due to incorrect equipping.

If the tubes in a bucket are too long, the swinging tubes will touch the rotor cross and may get damaged or destroyed.

- ▶ Equip buckets of swing-bucket rotors in such a way that they can swing out freely.
- ▶ If necessary, load the inner bores of the adapter only.
- ▶ If using tubes with a length > 100 mm: always perform a manual swing-out test.

If the adapter 16 x 75 mm – 100 mm (order number 5825 736.001) is equipped with vessels > 119 mm, e.g., BD 8 mL Vacutainer, this will result in danger of glass breakage.

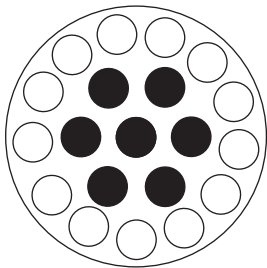

- ▶ Only equip the inner bores.

5.6.3.4 Rotor S-4x1000: Centrifugation of bottles 1000 mL

- ▶ When using 1000 mL flasks in the rotor S-4x1000, equip all 4 buckets with one flask each.

5.6.3.5 Rotor S-4xUniversal-Large: Loading buckets symmetrically

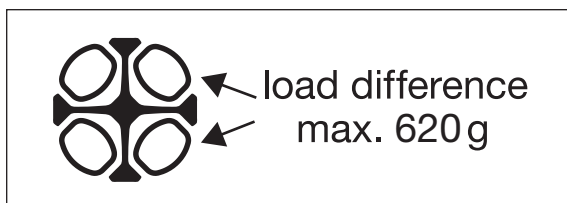

- ▶ Load adjoining buckets with a maximum of 620 g difference in weight.

5.6.4 Closing the bucket with the cap



NOTICE! Damage to the cap hook.

If the cap is not positioned correctly on the bucket, the sealing clamp may break during sealing.

- ▶ Before you fold the sealing clamp, check that the cap is positioned correctly.

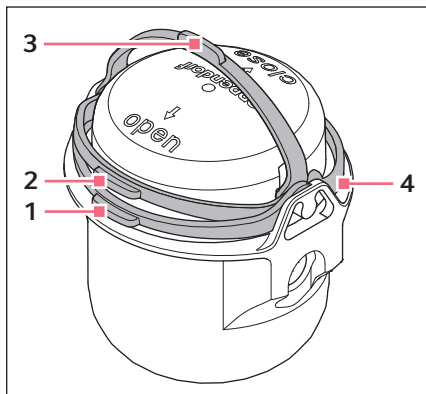

1. Fold the cap clamp to the **open** position (1).
2. Place the cap on the bucket and push the cap down in such a way that the clamp is lifted slightly (2).
3. To transport the bucket, fold the clamp to the carrying position (3).
4. To seal the bucket so that it is aerosol-tight, fold the clamp beyond the latch into the **close** position.
The clamp has only been folded correctly if there is an audible *click* (4).

5.6.5 Mixed equipping with different buckets

Mixed equipping of swing-bucket rotors with different buckets is possible if these are intended for the rotor. Buckets that are located opposite each other must be of the same type.

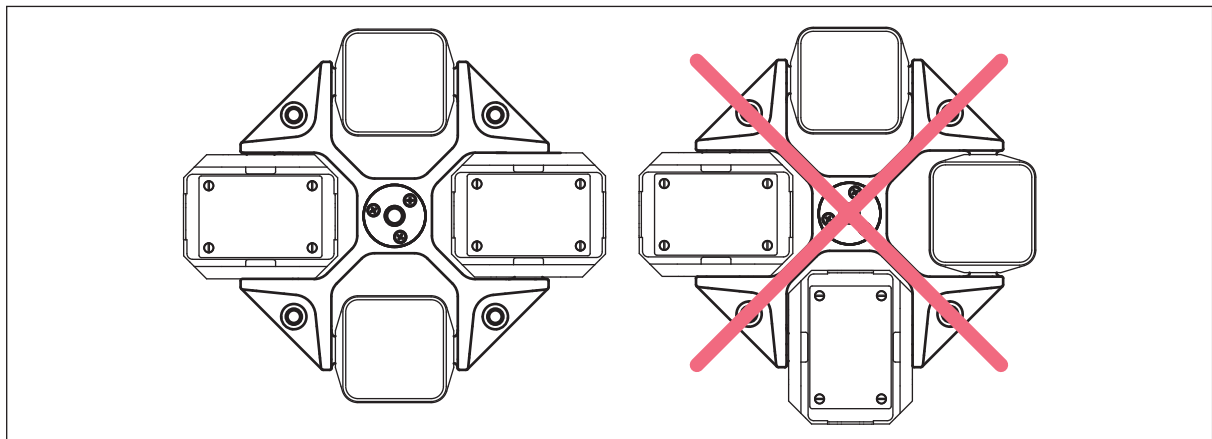

Fig. 5-7: Mixed equipping of a swing-bucket rotor

5.7 Closing the centrifuge lid



WARNING! Risk of injury when opening or closing the centrifuge lid.

There is a risk of crushing your fingers when opening or closing the centrifuge lid.

- ▶ Do not reach between the device and centrifuge lid when opening or closing the centrifuge lid.
 - ▶ Do not reach into the locking mechanism of the centrifuge lid.
 - ▶ Open the centrifuge lid fully to ensure that the centrifuge lid cannot slam shut.
-

1. Check that the rotor is attached correctly.
2. Press the centrifuge lid down until it is gripped by the lid latch. The lid will be closed automatically.
 - The LED next to the **open** key lights up in blue.
 - The ■ symbol appears on the display.

5.8 Aerosol-tight centrifugation



WARNING! Damage to health due to limited aerosol tightness with incorrect rotor/rotor lid combination.

Aerosol-tight centrifugation is guaranteed only if the rotors and rotor lids intended for this purpose are used. The designation of aerosol-tight fixed-angle rotors always starts with **FA**. The aerosol-tight rotors and rotor lids of this centrifuge are additionally marked with a red ring on the rotor and a red rotor lid screw.

- ▶ Always use rotors and rotor lids marked aerosol-tight together for aerosol-tight centrifugation. The details specifying in which centrifuge you may use the aerosol-tight rotors and rotor lids can be found on the rotor and on the top of the rotor lid.
- ▶ Only use aerosol-tight rotor lids in combination with rotors which are marked on the rotor lid.
- ▶ Only use aerosol-tight buckets with the corresponding caps.



WARNING! Damage to health as a result of limited aerosol tightness and incorrect usage.

Mechanical stresses and contamination by chemicals or other aggressive solvents may impair the aerosol tightness of the rotors and rotor lids. Autoclaving at excessive temperatures can lead to tubes, adapters and rotor lids becoming brittle and deformed.

- ▶ Check the integrity of the seals of the aerosol-tight rotor lids or caps before each use.
- ▶ Only use aerosol-tight rotor lids or caps if the seals are undamaged and clean.
- ▶ Do not exceed temperatures of 121°C or a time of more than 20 min. while autoclaving.
- ▶ After each proper autoclaving process (121 °C, 20 min.), coat the threads of the rotor lid screw with a thin layer of pivot grease (order no. Int. 5810 350.050, North America 022634330).
- ▶ For QuickLock rotor lids, only the seal must be replaced after 50 autoclaving cycles.
- ▶ Replace aerosol-tight rotor caps after 50 autoclaving cycles.
- ▶ **Never** store aerosol-tight rotors or buckets closed.



The aerosol tightness of rotors, rotor lids, buckets and caps has been tested and certified according to Annex AA of IEC 61010-2-020.

5.8.1 Aerosol-tight centrifugation in a fixed-angle rotor

Aerosol-tight fixed-angle rotors have a QuickLock rotor lid.

- ▶ Replace the seals of QuickLock rotor lids after 50 autoclaving cycles.
- ▶ Replace damaged seals of QuickLock rotor lids.

5.8.2 Aerosol-tight centrifugation in a swing-bucket rotor

- ▶ For aerosol-tight centrifugation in a swing-bucket rotor, use buckets with aerosol-tight caps.
- ▶ Replace aerosol-tight caps after 50 autoclaving cycles.

5.9 Centrifugation

Prerequisites

- The centrifuge is switched on.
- The rotor has been inserted and attached correctly.
- The rotor has been loaded correctly.
- The rotor lid has been mounted correctly.
- Buckets can swing out freely.
- The centrifuge lid is closed.



WARNING! Risk of injury from improperly attached rotors and rotor lids.

- ▶ Only centrifuge with the rotor and rotor lid firmly tightened.
 - ▶ If unusual noises occur when the centrifuge starts, the rotor or rotor lid may not be properly secured. Immediately press the **start/stop** key to stop centrifuging.
-

5.9.1 Centrifugation with time setting

Setting the centrifugation parameters

1. Set the centrifugation time with the **time** arrow keys.
2. Set the temperature with the **temp** arrow keys.
3. Set the rotational speed (rpm) or *g*-force (rcf) with the **speed** arrow keys.
If the speed is set via the *g*-force (rcf): check the radius (see *Setting the radius on p. 42*).

Starting the centrifugation run

4. To start the centrifugation run, press the **start/stop** key.

Display during centrifugation

-  flashes in the display when the rotor is running.
- Remaining run time in minutes. The last minute is counted down in seconds.
- Current temperature in the rotor chamber.
- Current *g*-force (rcf) and/or speed (rpm).
- Target values for centrifugation time, temperature and centrifugation speed in the target value row (if activated).



During the run you can change the following parameters:

- Centrifugation time: The shortest new run time that can be set must be 2 min above the elapsed time.
- Temperature
- Speed
During the run you can switch between the display of the *g*-force and the speed, using the **rpm/rcf** key.
- Radius
- Acceleration ramp/braking ramp

The following keys are blocked during centrifugation:

- **Standby**  key
- **open** key
- **short** key
- **prog 1** to **prog 5** program keys

5.9.2 End of centrifugation

- ▶ Press the **start/stop** key to end centrifugation before the set time.
- After completion of the set time, the centrifuge stops automatically.
- During the braking process, the elapsed running time flashes on the display.
- The signal sounds when the rotor is stopped.
- Time counter after rotor stop: A window on the display counts the time from the rotor stop to 10:00 h. Additionally, > 10:00 h is displayed.
- The LED of the **open** key flashes. The centrifuge lid remains sealed. Press the **open** key to open the lid.

5.9.3 Centrifuging in continuous operation

Setting up a continuous run

1. In order to centrifuge without any time limits, use the **time** arrow keys to select the setting *oo* (▼ below 10 s or ▲ above 99:59 h).
2. Set the temperature with the **temp** arrow keys.
3. Set the rotational speed (rpm) or *g*-force (rcf) with the **speed** arrow keys.
If the speed is set via the *g*-force (rcf): check the radius (see *Setting the radius on p. 42*).
4. To start the centrifugation run, press the **start/stop** key.
 -  flashes in the display when the rotor is running.
 - The cycle time is counted up.
 - Current temperature in the rotor chamber.
 - Current *g*-force (rcf) and/or speed.
5. Press the **start/stop** key to end the centrifugation.
 - During the braking process, the elapsed running time flashes on the display.
 - The signal sounds when the rotor is stopped.
6. Press the **open** key to open the lid.

5.9.4 Short run centrifugation

Setting in the menu item *Short spin*:

- *Maximum speed*: Short spin centrifugation at the maximum speed of the inserted rotor.
- *Current speed*: Short spin centrifugation at a freely selected speed.

The short spin centrifugation runs as long as the **short** key is pressed.

1. For short-spin centrifugation with *Current speed* only: Set the rotational speed (rpm) or *g*-force (rcf) with the **speed** arrow keys.
2. Set the temperature with the **temp** arrow keys.
3. Press and hold the **short** key to start short-spin centrifugation.
 -  flashes in the display when the rotor is running.
 - All other keys are disabled during short spin centrifugation.
4. To end short run centrifugation, release the **short** key.
During the braking process, the elapsed running time flashes on the display.
5. Press the **open** key to open the lid.



The set acceleration ramp/braking ramp is disabled during short run centrifugation.

5.9.5 Setting the radius

Prerequisites

The centrifuge has detected the rotor.

The value for the radius is set to the maximum radius of the rotor.

As a standard, the conversion from speed to g -force is based on the biggest radius of the rotor. If you are using an adapter for tubes, you can adjust the value for the radius manually. You can find the value for the radius of an adapter in a rotor in the Technical data of the rotor.

1. Press the **menu/enter** key. Use the menu arrow keys to select *Radius*. Confirm with the **menu/enter** key.



The display shows the maximum radius of the rotor and the g -force (rcf) in accordance with the set speed.

2. Use the menu arrow keys ◀ or ▶ to set the radius for the adapter.
The g -force (rcf) is adjusted to the value of the radius.
3. Select *Save* with the menu arrow keys ◀ or ▶. Confirm with the **menu/enter** key.
4. To exit the menu, press the left menu arrow key ◀ several times.

5.9.6 Setting the acceleration ramp and braking ramp



You can set the acceleration and deceleration times in levels from 0 to 9.







- Level 9: shortest acceleration time/deceleration time (setting on delivery).
- Level 0: longest acceleration time/deceleration time.

1. Press the **menu/enter** key. Use the menu arrow keys to select *Ramps*. Confirm with the **menu/enter** key.
2. Use the menu arrow keys ▲ or ▼ to select *Accel. ramp* ↗ or *Braking ramp* ↘.
3. Use the menu arrow keys ◀ or ▶ to select the level.
4. Select *Save* with the menu arrow keys ◀ or ▶. Confirm with the **menu/enter** key.

5.9.7 Setting the start of time counting (*At set rpm* function)

You can specify when time counting should begin:

- Time counting begins immediately: *At set rpm > Off*  (setting on delivery).
- Time counting starts when 95 % of the speed has been reached: *At set rpm > On* 

1. Press the **menu/enter** key. Use the menu arrow keys to select *At set rpm*. Confirm with the **menu/enter** key.
2. Use the menu arrow keys  or  to select *Off*  or *On* . Confirm with the **menu/enter** key.
The display shows  or .

5.10 Cooling

The centrifuge cools or maintains the set temperature if the following requirements are met:

- The centrifuge is switched on.
- The centrifuge lid is closed.
- Only during continuous cooling: The set temperature is lower than the ambient temperature.



- The temperature that can actually be reached depends on the rotor and the set rotational speed.
- If the rotor stops (continuous cooling), cooling is slower than during centrifugation or a temperature control run.

5.10.1 Setting the temperature

1. To set the temperature, use the **temp** arrow keys to select a temperature between -11 °C and 40 °C.
2. Set the run time and *g*-force (rcf) or speed (rpm). Press the **start/stop** key to start the centrifugation.
The temperature can be changed during centrifugation.

5.10.2 Temperature display

Temperature display if the rotor stops:	Set temperature
Temperature display during centrifugation:	Actual temperature

When the *Display > Extended display* setting is activated, the display shows the target values for centrifugation time, temperature and centrifugation speed in the target value row.

5.10.3 Temperature monitoring

After the set temperature has been reached, the centrifuge reacts to temperature deviations during centrifugation as follows:

- Deviation from the set temperature $> \pm 3$ °C:
Temperature display flashes.
- Deviation from the set temperature $> \pm 5$ °C:
The display shows *ERROR 18*. Centrifugation is stopped automatically.

5.10.4 Temperature control run FastTemp

Prerequisites

- The centrifuge is switched on.
- Rotor and rotor lid are correctly mounted.
- The centrifuge lid is closed.
- The temperature and g -force (rcf) or speed (rpm) have been set for the upcoming centrifugation.

With the FastTemp function, you can immediately start a temperature run without samples, at rotor-specific or temperature-specific speeds. This will quickly bring the rotor chamber, including rotor and adapter, up to the set target temperature.

1. Set the temperature with the **temp** arrow keys.
2. Press the **fast temp** key.

The display shows the following information:

- *FastTemp*
 - Duration of the temperature control run
 - Actual temperature in the rotor chamber
 - The optimum speed (rpm) calculated for the temperature control run or the g -force (rcf).
3. The temperature control run FastTemp automatically ends when the target temperature has been reached.
The signal sounds 5 times.

Press the **start/stop** key to end the temperature control run early.



- The centrifuge only stops the run once the rotor has reached the set temperature. Therefore, there may be a delay between the display of the achieved target temperature and the automatic end of the temperature control run.
- The target temperature can be changed during the temperature control run, using the **temp** arrow keys. Duration and speed are adjusted automatically.



FastTemp with aerosol-tight buckets

A temperature control run with aerosol-tight buckets takes longer and may lead to a vacuum in the bucket. To achieve better cooling of the bucket and the adapter, centrifugation can be carried out without cap during a FastTemp run.

- ▶ Do not seal aerosol-tight buckets during a FastTemp run.
- ▶ If the caps cannot be undone due to a vacuum, do not pull on the sealing clamps or hooks to loosen the cap. Adjust the temperature of the buckets to ambient temperature so that the caps can be removed easily.

5.10.5 FastTemp pro: automatic temperature control run with programmed start time

Prerequisites

- The centrifuge switches on and/or is in the standby mode at the set time.
- The rotor and rotor lid are properly attached.
- The centrifuge lid is closed.

You can set the FastTemp temperature control run to start automatically at a set time. Two options are available:

- *FastTemp pro* > *One time use*: The temperature control run starts once at the set time.
- *FastTemp pro* > *Repeated use*: The temperature control run starts at the set time on the set weekday and repeats indefinitely on each additional weekday that was set.

The selection between *One time use* and *Repeated use* only appears when the FastTemp pro function has not been activated yet. If this is not the case, you can edit or delete the programmed start time.

Programming a single temperature control run

1. Press the **menu/enter** key. Use the menu arrow keys to select *Cooling System* > *FastTemp pro*.
2. Use the menu arrow keys to select *One time use*. Confirm with the **menu/enter** key.
3. Set the date, time and temperature with the menu arrow keys. Confirm with the **menu/enter** key.
The display shows an overview of the current settings.
4. Use the menu arrow keys to select *Save*. Confirm with the **menu/enter** key.

Programming repeated temperature control runs

1. Press the **menu/enter** key. Use the menu arrow keys to select *Cooling System* > *FastTemp pro*.
2. Use the menu arrow keys to select *Repeated use*. Confirm with the **menu/enter** key.
3. Activate or deactivate the weekdays with **menu/enter**. Select *Next* and confirm with **menu/enter**.
4. Set the date, time and temperature with the menu arrow keys. Confirm with the **menu/enter** key.
The display shows an overview of the current settings.
5. Use the menu arrow keys to select *Save*. Confirm with the **menu/enter** key.
 - When FastTemp pro is activated, the **FTpro** symbol appears on the display while an automatic start of a temperature control run is still outstanding.
 - The temperature control run starts automatically at the selected time.
 - After a one-off programmed temperature control run, the following symbol is extinguished **FTpro**. If there are several programmed temperature control runs, the FastTemp pro function remains active indefinitely.



If the centrifuge is running at the programmed time, the temperature control run cannot be started automatically.

Deactivating FastTemp pro

1. Press the **menu/enter** key. Use the menu arrow keys to select *Cooling System* > *FastTemp pro*.
2. Use the menu arrow keys to select *Delete*. Confirm with the **menu/enter** key.

5.10.6 Continuous cooling

Prerequisites

- The centrifuge is switched on.
- The centrifuge lid is closed.
- The set temperature is lower than the ambient temperature.

Continuous cooling maintains the rotor chamber at the set temperature if the rotor stops.

- During continuous cooling the display shows the set temperature.
- To prevent the rotor chamber from freezing or condensation from forming, the temperature does not go below 4 °C , irrespective of the set temperature.
- If the rotor stops, temperature control is slower than during centrifugation or a temperature control run.

ECO shut-off

ECO shut-off: Continuous cooling is switched off if the centrifuge is not used for longer than the preset time. The centrifuge switches to standby mode.

- Default setting: Continuous cooling ends after 8 h.
- Continuous cooling can be limited to 1 h, 2 h or 4 h.
- ECO shut-off can be switched off (continuous cooling set to endless operation).

Limit continuous cooling to 1 h (2 h, 4 h, 8 h)

1. Press the **menu/enter** key. Use the menu arrow keys to select *Cooling System > Continuous cooling*. Confirm with the **menu/enter** key.
2. Use the menu arrow keys to select *Eco shut-off*. Confirm with the **menu/enter** key.
3. Select *1 h, 2 h, 4 h or 8 h*. Confirm with the **menu/enter** key.
Continuous cooling ends after the preset time. The centrifuge switches to standby mode.

5.10.7 Endless operation of continuous cooling

The ECO shut-off function can be switched off. Continuous cooling is changed to endless operation.

- Endless operation can shorten the service life of the compressor.
 - The rotor chamber may freeze.
1. Press the **menu/enter** key. Use the menu arrow keys to select *Cooling System > Continuous cooling*. Confirm with the **menu/enter** key.
 2. Use the menu arrow keys to select ∞ . Confirm with the **menu/enter** key.

Ending continuous cooling

3. Open the centrifuge lid to end continuous cooling.

5.11 Switching off the centrifuge

1. Open the centrifuge lid.
Residual moisture can evaporate. Pressure is taken off the gas springs.
2. Remove rotor lids from fixed-angle rotors and aerosol-tight caps from buckets.
Aerosol-tight accessories may not be stored when they are connected.
3. Switch off the centrifuge using the mains/power switch.

6 Device settings

6.1 Standby mode

The centrifuge automatically switches from the ready state to the standby mode if the following prerequisites are met:

- The centrifuge is not used during the defined time period.
- The centrifuge lid is open.

Standby mode

- The LED next to the **Standby**  key lights up red.

Ready state

- The centrifugation parameters are displayed.
- The LED next to the **Standby**  key lights up green.

You can switch between the standby mode and ready state at any time when centrifugation is not performed by pressing the **Standby**  key.

6.1.1 Switching on the standby mode

1. Press the **menu/enter** key. Use the menu arrow keys to select *Settings > Standby*.
2. Use the menu arrow keys to select *OnOff* or *Set time*. Confirm with the **menu/enter** key.
If *Standby > Set time* is selected, the time period can be selected after which the centrifuge is to switch to standby mode (1 min to 60 min).

6.2 Key lock

When the key lock has been enabled, the centrifugation time, the temperature, the *g*-force (rcf) and/or RPM, the acceleration ramp/braking ramp and the status of the At set rpm function cannot be changed accidentally.

1. To enable the key lock, press the **menu/enter** key. Use the menu arrow keys to select *Key lock*. Confirm with the **menu/enter** key.
2. Use the menu arrow keys to select *On*. Confirm with the **menu/enter** key.
A tick appears in front of the selected setting. The setting takes effect immediately.
3. To exit the menu, press the left menu arrow key  several times.

6.3 Display

Standard display	When the centrifuge stands still, the set values are displayed and during centrifuging the actual values of the centrifugation parameters are displayed.
Extended display	The set value row is shown on the lower edge of the display.

6.3.1 Showing the set value row

1. Press the **menu/enter** key. Use the menu arrow keys to select *Settings > Display*. Confirm with the **menu/enter** key.
2. Use the menu arrow keys to select *Extended display*. Confirm with the **menu/enter** key.
A tick appears in front of the selected setting. The setting takes effect immediately.
3. To exit the menu, press the left menu arrow key ◀ several times.

6.3.2 Setting the contrast

1. Press the **menu/enter** key. Use the menu arrow keys to select *Settings > Contrast*. Confirm with the **menu/enter** key.
2. Change parameters with the menu arrow keys ◀ or ▶.
3. Select *Save*. Confirm with the **menu/enter** key.

6.4 Speaker

6.4.1 Switching the loudspeaker on/off

1. Press the **menu/enter** key. Use the menu arrow keys to select *Settings > Alarm*. Confirm with the **menu/enter** key.
2. Use the menu arrow keys to select *On* or *Off*. Confirm with the **menu/enter** key.
A tick appears in front of the selected setting. The setting takes effect immediately.
3. To exit the menu, press the left menu arrow key ◀ several times.

6.4.2 Setting the volume

1. Press the **menu/enter** key. Use the menu arrow keys to select *Settings > Volume*. Confirm with the **menu/enter** key.
2. Change parameters with the menu arrow keys ◀ or ▶.
3. Select *Save*. Confirm with the **menu/enter** key.

6.5 Calling up device information

- ▶ Press the **menu/enter** key. Use the menu arrow keys to select *Information > Device Information*. Confirm with the **menu/enter** key.
Device name, serial number and firmware version are displayed.

6.6 Cycle counter

Each centrifugation run in which the rotor is accelerated and braked is counted as a cycle, independent of the speed and the duration of the centrifugation run.

The usual service life of a rotor is 7 years or a maximum of 100000 cycles (see p. 74). If you expect a rotor to exceed the maximum number of cycles before the end of the 7 years, use the cycle counter as an aid.

The centrifuge detects the rotor type, but not each individual rotor. The displayed number of cycles does not give reliable information on the actual service life of a rotor.

Using the cycle counter is recommendable under the following conditions:

- Only one rotor of a rotor type is used in the centrifuge. There are no rotors of the same type in one centrifuge.
- The rotor is only used in one centrifuge. It is not used in parallel in different centrifuges.

6.6.1 Notes on reaching the maximum number of cycles



CAUTION! Danger due to material fatigue.

When the service life is exceeded, it cannot be guaranteed that the material of the rotors and accessories will withstand the stresses during centrifugation.

- ▶ Do not use any accessories which have exceeded their maximum service life.

Before the maximum number of cycles of a rotor is reached, a pop-up window will appear that the rotor must be exchanged.

At the following 3 times, a pop-up window will appear that the maximum number of cycles has been reached:

- 2000 cycles before reaching the maximum number of cycles
- 1000 cycles before reaching the maximum number of cycles
- 400 cycles before reaching the maximum number of cycles



- ▶ Confirm with the **menu/enter** key.
- ▶ Press the **start/stop** key to start the centrifugation.

If the maximum number of cycles has been reached, a warning will appear before each run.



- ▶ Confirm with the **menu/enter** key.
- ▶ Replace the rotor.

6.6.2 Resetting the number of cycles

After a rotor has reached the maximum number of cycles and has been replaced, the number of cycles must be reset for the rotor type.

1. Press the **menu/enter** key. Use the menu arrow keys to select *Information > Number of Cycles*. Confirm with the **menu/enter** key.

The display shows the rotor type, the cycles run and the maximum cycles.



2. Select a rotor with the arrow keys ▲ or ▼. Confirm with the **menu/enter** key.
3. Select *Reset* with the menu arrow keys ◀ or ▶. Confirm with the **menu/enter** key.

The display shows:

Reset cycles?
yes/no

4. Select *yes*. Confirm with the **menu/enter** key.

The number of cycles for the rotor type will be reset to 1.

6.6.3 Changing the number of cycles

The function *Number of Cycles > Change* is intended for the authorized service only.

7 Programs

7.1 Saving the program

The Centrifuge 5920 R has more than 99 programmable memory locations.

For each program, you can define the parameters centrifugation time, temperature and speed as well as separate settings for radius, acceleration ramps/braking ramps and the start of time counting (At set rpm function). With the timer function, you can delay the start time by up to 60 min, for instance, to bridge an incubation period.

Option	Value
<i>Radius [cm]</i>	Radius in [cm] The centrifuge must have detected the rotor.
<i>Accel. ramp</i>	0 to 9
<i>Braking ramp</i>	0 to 9
<i>At set rpm</i>	Off On
<i>Timer [min]</i>	1 min to 60 min

7.1.1 Creating a program

Prerequisites

- The centrifuge has detected the rotor.
- Rotor stop.

1. Press the **menu/enter** key. Use the menu arrow keys to select *Programs > Save program*. Confirm with the **menu/enter** key.
2. Set the centrifugation time with the **time** arrow keys.
3. Set the temperature with the **temp** arrow keys.
4. Set the speed (rpm) or the *g*-force (rcf) with the **speed** arrow keys.



Defining additional options of the program

5. Select *Options* using the right menu arrow key ►. Confirm with the **menu/enter** key.
6. Select an option, for instance, *Accel. ramp*, with the menu arrow keys ◀ or ▶.
7. Change parameters with the menu arrow keys ◀ or ▶. Confirm with the **menu/enter** key.

Programs

Centrifuge 5920 R
English (EN)

Saving the program. 8. Use the menu arrow keys to select an empty program space.

9. Use the menu arrow keys to select *Save*. Confirm with the **menu/enter** key.

- The program is saved in the program space (without a program name).
- The display shows the message *Assign a program name?*

Allocating a program name

10. Confirm with *yes*.

P 12	HARVEST E.COLI	
▲	A B C D E F G H I J K L M	Delete
◀ ▶	N O P Q R S T U V W X Y Z	Save
▼	0 1 2 3 4 5 6 7 8 9 ()	Cancel
enter	* + - = . : ; / \ [] < >	

11. Select letters or numbers with the menu arrow keys and confirm with the **menu/enter** key.

The program name can have a maximum of 15 characters.

To delete individual characters, select *Delete* and press the **menu/enter** key.

12. Use the menu arrow keys to select *Save*. Confirm with the **menu/enter** key.

The display shows the program with all settings.



If the message *Assign a program name?* is discarded with *no*, a name is generated from the program number, e.g. *Prog. 12*.

7.1.2 Quick save with program keys

To save the current settings quickly, you can use the program keys.

- ▶ Keep one of the program keys **prog 1** to **prog 5** pressed for 2 seconds.
 - A signal tone sounds.
 - The LED above the program key lights blue.
 - The parameters of the program are saved.



prog 1 to **prog 5** cover the program spaces 1 to 5. The programs are saved without a program name.

7.2 Loading a saved program

7.2.1 Loading program prog 1 to prog 5

1. In order to call up a program on the program spaces 1 to 5, press one of the program keys **prog 1** to **prog 5**.
 - The LED above the program key lights blue.
 - The display shows the parameters of the program.
2. Start the program: press the **start/stop** key.

7.2.2 Loading a program from the program list

Prerequisites

- The rotor which is suitable for the program is inserted.
 - The centrifuge has detected the rotor.
1. Press the **menu/enter** key. Select *Programs > Load program*. Confirm with the **menu/enter** key.
 2. Use the menu arrow keys ◀ or ▶ to select the program space. Confirm with the **menu/enter** key.
The display shows the parameters of the program.
 3. Start the program: press the **start/stop** key.

7.2.2.1 Error messages

If a run is started although the rotor is not compatible with the parameters of a program, notes on the possible causes will appear:

Speed is flashing in the display



g-force/speed is flashing in the display: *g-force/speed* of the selected program exceeds the maximum *g-force/speed* of the rotor.

- ▶ Correct the value for *g-force/speed*.

If the run is started without correcting the *g-force/speed*, the following message will appear:

rpm/rcf too high!

[START] Centrifugation at ### rpm/### rcf

◀ ▶ *Change parameters.*

- The message shows the maximum permitted *g-force/speed* of the rotor.
 - The rotor is not stopped, but it is held at a speed of 700 rpm.
 - You have 15 seconds to adopt the *g-force/speed* or to change it.
- ▶ Adopt the displayed *g-force/speed* for the run: press the **start/stop** key.
 - ▶ Change the *g-force* or speed for the run: use the arrow keys **speed** to set a different value.
If you do not adopt or change the *g-force/speed* within 15 s, the centrifuge will stop running.

Radius is flashing in the display



Radius is flashing in the display: The radius of the selected program is larger than the maximum radius of the rotor.

- ▶ Correct the value for radius.

If the run is started without correcting the radius, the following message will appear:

Hint D

Radius not permissible.

Change rotor.

7.2.3 Editing programs

1. Load the program with the program keys: *Menu > Programs > Load program*. Confirm with the **menu/enter** key.
2. Select a program with the menu arrow keys ◀ or ▶. Confirm with the **menu/enter** key.
The display shows the parameters of the program.
3. Press the **menu/enter** key. Use the menu arrow keys to select *Programs > Save program*. Confirm with the **menu/enter** key.
The next available program space is suggested.
4. Change parameters and options (see *Creating a program on p. 53*).
5. Select *Save*. Confirm with the **menu/enter** key.
The display shows the message *Keep program name?*
6. To change the program name, discard the message with *no* and change the program name.

7.3 Deleting a program

Programs 1 to 5 cannot be deleted. All parameters of these programs can be modified and overwritten.

1. To delete a program from program spaces 6 to 99: press the **menu/enter** key. Select *Programs > Delete program*. Confirm with the **menu/enter** key
2. Use the menu arrow keys ◀ or ▶ to select the program space. Confirm with the **menu/enter** key.
The display shows the message *Delete program?*
3. Select *yes*. Confirm with the **menu/enter** key.

8 Maintenance

8.1 Service



WARNING! Risk of injury due to defective gas spring(s).

A defective gas spring is an insufficient support for the centrifuge lid. There is a risk of crushing fingers or limbs.

- ▶ Make sure that the centrifuge lid can be opened fully and that it will remain in this position.
- ▶ Regularly check all gas springs for their proper function.
- ▶ Have defective gas springs replaced immediately.
- ▶ Have gas springs replaced by a service technician every 2 years.



WARNING! Risk of fire or electrical shock

- ▶ Have the centrifuge's electrical safety, especially the paths for the protective connections, checked every 12 months by trained and skilled personnel.
-

We recommend to have the centrifuge and the associated rotors checked by Technical Service during a service at least every 12 months. Please note the country-specific regulations.

8.2 Preparing cleaning/disinfection

- ▶ Clean all accessible surfaces of the device and the accessories at least weekly and when contaminated.
- ▶ Clean the rotor regularly. This way the rotor is protected and the durability is prolonged.
- ▶ Furthermore, observe the notes on decontamination (see *Decontamination before shipment on p. 64*) when the device is sent to the authorized Technical Service for repairs.

The procedure described in the following chapter applies to the cleaning as well as to the disinfection or decontamination. The table below describes the steps required on top of this:

Cleaning	Disinfecting/decontamination
<ol style="list-style-type: none"> 1. Use a mild cleaning fluid to clean the accessible surfaces of the device and the accessories. 2. Carry out the cleaning as described in the following chapter. 	<ol style="list-style-type: none"> 1. Choose the disinfection method which corresponds to the legal regulations and guidelines in place for your range of application. For example, use alcohol (ethanol, isopropanol) or alcohol-based disinfectants. 2. Carry out the disinfection or decontamination as described in the following chapter. 3. Then clean the device and the accessories.



If you have any further questions regarding the cleaning and disinfection or decontamination or regarding the cleaning fluid to be used, contact the Eppendorf AG Application Support. The contact details are provided on the back of this manual.

8.3 Cleaning/disinfection



DANGER! Electric shock due to the ingress of liquid.

- ▶ Switch off the device and disconnect it from the mains/power line before starting cleaning or disinfection.
- ▶ Do not allow any liquids to penetrate the inside of the housing.
- ▶ Do not perform a spray clean/spray disinfection on the housing.
- ▶ Only reconnect the device to the mains/power line when it is completely dry, both inside and outside.



WARNING! Damage to health as a result of limited aerosol tightness and incorrect usage.

Mechanical stresses and contamination by chemicals or other aggressive solvents may impair the aerosol tightness of the rotors and rotor lids. Autoclaving at excessive temperatures can lead to tubes, adapters and rotor lids becoming brittle and deformed.

- ▶ Check the integrity of the seals of the aerosol-tight rotor lids or caps before each use.
- ▶ Only use aerosol-tight rotor lids or caps if the seals are undamaged and clean.
- ▶ Do not exceed temperatures of 121°C or a time of more than 20 min. while autoclaving.
- ▶ After each proper autoclaving process (121 °C, 20 min.), coat the threads of the rotor lid screw with a thin layer of pivot grease (order no. Int. 5810 350.050, North America 022634330).
- ▶ For QuickLock rotor lids, only the seal must be replaced after 50 autoclaving cycles.
- ▶ Replace aerosol-tight rotor caps after 50 autoclaving cycles.
- ▶ **Never** store aerosol-tight rotors or buckets closed.



NOTICE! Danger due to deformed or brittle tubes. Autoclaving at excessive temperatures can lead to tubes made from plastic becoming brittle and deformed.

This could cause damage to the device and the accessories and sample loss.

- ▶ Observe the temperatures specified by the manufacturer when autoclaving tubes.
- ▶ Do not use brittle or deformed rechargeable tubes.



NOTICE! Damage from the use of aggressive chemicals.

- ▶ Do not use any aggressive chemicals on the device or its accessories, such as strong and weak bases, strong acids, acetone, formaldehyde, halogenated hydrocarbons or phenol.
- ▶ If the device has been contaminated by aggressive chemicals, clean it immediately using a mild cleaning agent.



NOTICE! Corrosion due to aggressive cleaning agents and disinfectants.

- ▶ Do not use any corrosive cleaning agents, aggressive solvents or abrasive polishes.
- ▶ Do not incubate the accessories in aggressive cleaning agents or disinfectants for longer periods.



NOTICE! Damage from UV and other high-energy radiation.

- ▶ Do not use UV, beta, gamma, or any other high-energy radiation for disinfection.
 - ▶ Avoid storage in areas with strong UV radiation.
-



Autoclaving

Fixed-angle rotors, rotor lids, adapters, and buckets can be autoclaved (121 °C, 20 min).

Rotor crosses of swing-bucket rotors cannot be autoclaved.

After a maximum of 50 autoclaving cycles, the aerosol-tight caps and, for QuickLock rotors, the seals must be replaced.



Aerosol tightness

Check that the seals are intact before use.

Replace the rotor lids with screw cap when the sealing rings on the lid screw and in the lid groove become worn.

Regular care of the sealing rings is necessary in order to protect the rotors.

Aerosol-tight rotors should never be stored with lids screwed on!

In order to prevent damage, lightly lubricate the lid thread of the aerosol-tight rotors regularly with pivot grease (order no. int.: 5810 350.050/North America: 022634330).

8.3.1 Cleaning and disinfecting the device

Recommended cleaning agents:

- Alcohol 70 % (ethanol, isopropanol)
- Mild neutral cleaning agent

1. Open the lid. Switch the device off at the mains/power switch. Disconnect the mains/power plug from the voltage supply.
2. Remove the rotor.
3. Clean and disinfect all accessible surfaces of the device, including the power cable, using a damp cloth and the recommended cleaning agents.
4. Wash the rubber seal in the rotor chamber thoroughly with water.
5. Rub the dry rubber seal with glycerol or talcum powder to prevent it from becoming brittle. Other components of the device, such as the motor shaft and rotor cone, must not be lubricated.
6. Clean the motor shaft with a soft, dry, lint-free cloth. Do not grease the motor shaft.
7. Check the motor shaft for damage.
8. Check the device for corrosion and damage.
9. Leave the centrifuge lid open when the device is not being used.
10. Only connect the device to the power supply if it is fully dry inside and out.

8.3.2 Disinfecting and cleaning the rotor

1. Inspect the rotor and accessories for damage and corrosion. Do not use any damaged rotors or accessories.
2. Clean and disinfect the rotors and accessories using the recommended cleaning agents.
3. Clean and disinfect the rotor bores using a bottle brush.
4. Clean and disinfect the rotor lid.

QuickLock rotor lids: Remove the sealing ring. Clean the sealing ring and the groove below it.

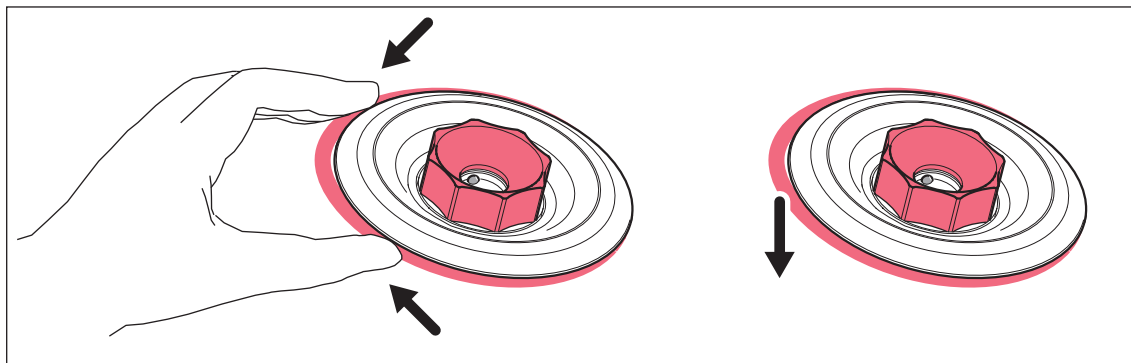

5. Rinse the rotors and accessories thoroughly with distilled water. Rinse the rotor bores of fixed-angle rotors particularly thoroughly.



Do not immerse the rotor in liquid as liquid can get trapped inside the cavities.

6. Place the rotors and accessories on a towel to dry. Place the fixed-angle rotors with the rotor bores facing down so the bores can dry.
7. Coat the sealing ring of the rotor lid with a thin layer of pivot grease and Correctly reinsert it in the clean and dry groove.
8. Clean the rotor cone with a soft, dry, lint-free cloth. Do not lubricate the rotor cone.
9. Inspect the rotor cone for damage.
10. Place the dry rotor onto the motor shaft.
11. Tighten the rotor nut firmly by turning it **clockwise** with the rotor key.
12. Leave the rotor lid open when the rotor is not being used.

8.3.3 Changing the seal of the aerosol-tight cap

To clean the aerosol-tight cap, remove the gasket of the aerosol-tight cap.

8.3.3.1 Removing the seal

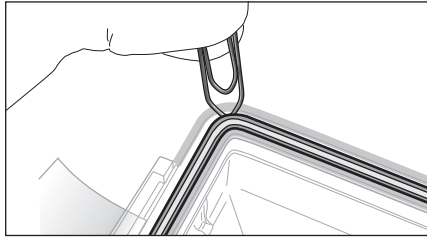

1. Use a blunt lever to lift the seal out of the groove (e.g., use the round side of a paper clip). Make sure not to damage the seal with the wire ends.
2. Carefully lift the seal out of the groove.

8.3.3.2 Inserting the seal



NOTICE! Faulty sealing if the seal is handled incorrectly.

- ▶ Insert the seal evenly.
- ▶ Do not pull the seal lengthways.

1. Check that the seal is not damaged.
Do not use any damaged, discolored or dirty seals.
2. Place the seal on the groove and slightly press it into the groove.
3. Place the cap on the bucket and close it completely.
4. Remove the cap and check the correct positioning of the seal.



If the seal is too long or too short, remove the seal from the groove. Insert the seal again.

8.4 Additional care instructions for refrigerated centrifuges

- ▶ Regularly free the rotor chamber from ice formations by thawing, by either leaving the centrifuge lid open or by performing a short temperature control run at approx. 30 °C.
- ▶ To take pressure off the gas spring(s), leave the centrifuge lid open if the centrifuge is not used for a longer period.
Residual moisture can escape.
- ▶ Wipe up the condensation water in the rotor chamber. Use a soft, absorbent cloth for this.
- ▶ No later than every 6 months, remove any dust deposits from the ventilation slits of the centrifuge using a brush or swab. First switch off the device and remove the power plug.

8.5 Cleaning glass breakage

When using glass tubes there is a risk of glass breakage in the rotor chamber. The resulting glass splinters are swirled around in the rotor chamber during centrifugation and have a sandblasting effect on the rotor and accessories. The smallest glass particles become lodged in the rubber parts (e.g., the motor guide, the rotor chamber seal, and the rubber mats of adapters).



NOTICE! Glass breakage in the rotor chamber

Glass tubes in the rotor chamber may break if the *g*-force is too high. Broken glass can damage the rotor, accessories and samples.

- ▶ Please note the manufacturer's information on the recommended centrifugation parameters (load and speed).
-

Effects of glass breakage in the rotor chamber:

- Fine black metal abrasion in the rotor chamber (in metal rotor chambers)
- The surfaces of the rotor chamber and accessories are scratched.
- The chemical resistance of the rotor chamber is reduced.
- Contamination of samples
- Wear on rubber parts

How to proceed in case of glass breakage

1. Remove all splinters and glass powder from the rotor chamber and accessories.
2. Thoroughly clean the rotor and rotor chamber. Thoroughly clean the bores of the fixed-angle rotors, in particular.
3. If required, replace the rubber mats and adapters to prevent any further damage.
4. Regularly check the rotor bores for deposits and damage.

8.6 Resetting the excess current switch

Thermal excess current switches are mounted as fuses. If the excess current protection is triggered, they set the switch to OFF. However, they do not automatically switch it on again.

To switch on the excess current switch again, proceed as follows:

1. Switch off the centrifuge using the mains/power switch.
2. Wait for at least 20 s and switch on the centrifuge again.

The excess current switch is reactivated and the centrifuge is ready for operation.

8.7 Decontamination before shipment

If you are shipping the device to the authorized Technical Service for repairs or to your authorized dealer for disposal please note the following:



WARNING! Risk to health from contaminated device.

1. Observe the information in the decontamination certificate. It is available as a PDF document on our webpage (www.eppendorf.com/decontamination).
 2. Decontaminate all the parts you are going to dispatch.
 3. Include the fully completed decontamination certificate in the shipment.
-

9 Troubleshooting

If you cannot remedy an error with the recommended measures, please contact your local Eppendorf partner. The contact addresses can be found on the Internet at www.eppendorf.com.

9.1 General errors

Problem	Cause	Solution
No display.	No mains/power connection.	▶ Check the mains/power connection.
	Mains/power outage.	▶ Check the fuse of the device. ▶ Check the mains/power fuse of the laboratory.
The centrifuge lid cannot be opened.	Rotor is still running.	▶ Wait for rotor to stop.
	Mains/power outage.	1. Check the fuse of the device. 2. Check the mains/power fuse of the laboratory. 3. Actuate emergency release.
The centrifuge cannot be started.	Centrifuge lid is not closed.	▶ Closing the centrifuge lid.
Centrifuge shakes when it starts up.	Rotor is asymmetrically loaded.	1. Stop the centrifuge and load the rotor symmetrically. 2. Re-start the centrifuge.
Centrifuge brakes during short spin centrifugation even though the short key is pressed.	The short key was released briefly more than twice (protective function for the drive).	▶ Press and hold the short key during a short spin centrifugation.
Temperature display flashes.	Temperature deviation from set value: $> \pm 3 \text{ }^{\circ}\text{C}$.	▶ Check the settings. ▶ Wait until the set temperature has been reached. ▶ Check unhindered air circulation through the air slots. ▶ Thaw ice or switch off device and allow it to cool down.

9.2 Error messages

If an error message appears, proceed as follows:

1. Remedy the fault as described in the "Remedy" column.
2. To clear the error message from the display, press the **open** key.
3. If necessary, repeat centrifugation.

Problem	Cause	Solution
<i>Hint A</i> <i>Lid latch</i>	Centrifuge lid will not lock.	▶ Try again to close centrifuge lid.
<i>Hint B</i> <i>Imbalance</i>	Rotor is asymmetrically loaded.	▶ Load the rotor symmetrically and balance it. ▶ Swing-bucket rotor: Apply a thin layer of pivot grease to the pegs.
<i>Hint C</i> <i>Rotor detection</i>	Speed (rpm) or <i>g</i> -force (rcf) is higher than the maximum speed (rpm) or the <i>g</i> -force (rcf) of the rotor.	1. Correct rpm/rcf. 2. Repeat the run.
<i>Hint D</i> <i>Rotor detection</i>	<ul style="list-style-type: none"> • The radius of the selected program is larger than the maximum radius of the rotor. • The rotor is not compatible with the program. 	▶ Change the radius. ▶ Replace the rotor.

Problem	Cause	Solution
<i>ERROR 1</i> <i>Rotor detection</i>	Rotor not detected.	▶ Check rotor. ▶ If this error message appears again, test the rotor detection with a different rotor.
<i>ERROR 2</i> <i>Electronics fault</i>	Electronics fault.	1. Switch off centrifuge and wait for 20 s. 2. Switch on centrifuge.
<i>ERROR 3</i> <i>Speed check</i>	Error in the rotational speed measurement system.	▶ Insert and tighten rotor. ▶ Wait for displayed time to elapse. ▶ Let the centrifuge stand while switched on until the error message disappears.
<i>ERROR 5</i> <i>Electronics fault</i>	Prohibited opening of lid during a run or lid switch is defective.	1. Wait for rotor to stop. 2. Open and close again the lid of the device. 3. Repeat the run.

Problem	Cause	Solution
<i>ERROR 6</i> <i>Drive fault</i>	<ul style="list-style-type: none"> • Error in the drive electronics. • Drive is overheated. 	<p>▶ Repeat the run.</p> <p>If the error message appears again:</p> <ol style="list-style-type: none"> 1. Switch off centrifuge and wait for 20 s. 2. Switch on centrifuge. <p>If the error message appears again:</p> <p>▶ Let the drive cool down for at least 15 min.</p>
	<ul style="list-style-type: none"> • Emergency release was actuated during a run. 	<p>▶ Wait for rotor to stop.</p>
<i>ERROR 7</i> <i>Speed check</i>	Deviation in the speed control.	<ol style="list-style-type: none"> 1. Wait for rotor to stop. 2. Tighten the rotor.
<i>ERROR 9 –</i> <i>ERROR 14</i>	Electronics fault.	<ol style="list-style-type: none"> 1. Switch off centrifuge and wait for 20 s. 2. Switch on centrifuge.
<i>ERROR 16 –</i> <i>ERROR 17</i> <i>Electronics fault</i>	Electronics fault.	<ol style="list-style-type: none"> 1. Switch off centrifuge and wait for 20 s. 2. Switch on centrifuge.
<i>ERROR 18,</i> <i>ERROR 20</i> <i>Room Temp. of</i> <i>rotor chamber</i>	Deviation from target temperature in the rotor chamber.	<p>▶ Allow the device to cool down and repeat cycle.</p>
<i>ERROR 22</i> <i>Electronics fault</i>	Electronics fault.	<ol style="list-style-type: none"> 1. Switch off centrifuge and wait for 20 s. 2. Switch on centrifuge.
<i>ERROR 25</i> <i>Power failure</i>	Mains/power failure during a run.	<p>▶ Check the power supply.</p>
<i>ERROR 26 –</i> <i>ERROR 27</i> <i>Electronics fault</i>	Electronics fault.	<ol style="list-style-type: none"> 1. Switch off centrifuge and wait for 20 s. 2. Switch on centrifuge.
<i>ERROR 28</i> <i>Electronics fault</i>	Electronics fault.	<p>▶ Press the open key.</p>
<i>ERROR 30</i> <i>Lid latch</i>	Centrifuge lid will not lock.	<p>▶ Try again to close centrifuge lid.</p>
	Centrifuge lid cannot be released.	<p>▶ Switch the device off and back on.</p> <p>If the error occurs again:</p> <ol style="list-style-type: none"> 1. Switch off the device. 2. Activate the emergency lid release.
	Centrifuge lid has not been opened wide enough.	<p>▶ Open the centrifuge lid wider by hand.</p>

9.3 Emergency release

If the centrifuge lid cannot be opened, you can activate the emergency release manually.



WARNING! Risk of injury from rotating rotor.

If the emergency release of the lid is operated, the rotor may continue to rotate for several minutes.

- ▶ Wait for the rotor to stop before activating the emergency release.
 - ▶ To check, look through the monitoring glass in the centrifuge lid.
-

Use the rotor key delivered with the Centrifuge 5920 R for the emergency release. Carry out the following steps on both the left side and right side of the centrifuge.

1. Pull out the mains/power plug and wait for the rotor to stop.
2. Insert the rotor key into the hexagonal opening on one side of the centrifuge until noticeable resistance can be felt.
3. Slightly press and turn the rotor key **counterclockwise**.
4. Insert the rotor key into the hexagonal opening on the opposite side of the centrifuge until noticeable resistance can be felt.
5. Slightly press and turn the rotor key **counterclockwise**.
This will release the centrifuge lid.
6. Open the centrifuge lid.

10 Transport, storage and disposal
10.1 Transport



CAUTION! Risk of injury due to lifting and carrying of heavy loads
 The device is heavy. Lifting and carrying the device can lead to back injuries.

- ▶ Transport and lift the device with an adequate number of helpers only.
- ▶ Use a transport aid for transporting the device.

- ▶ Remove the rotor from the centrifuge before transport.
- ▶ Use the original packing for transport.

	Air temperature	Relative humidity	Atmospheric pressure
General transport	-25 °C – 60 °C	10 % – 75 %	30 kPa – 106 kPa
Air freight	-20 °C – 55 °C	10 % – 75 %	30 kPa – 106 kPa

10.2 Storage

	Air temperature	Relative humidity	Atmospheric pressure
In transport packing	-25 °C – 55 °C	10 % – 75 %	70 kPa – 106 kPa
Without transport packing	-5 °C – 45 °C	10 % – 75 %	70 kPa – 106 kPa

10.3 Disposal

If the product needs to be disposed of, the relevant legal regulations must be observed.

Information on the disposal of electrical and electronic devices in the European Community:

Within the European Community, the disposal of electrical devices is regulated by national regulations based on EU Directive 2012/19/EU pertaining to waste electrical and electronic equipment (WEEE).

According to these regulations, any devices supplied after August 13, 2005, in the business-to-business sphere, to which this product is assigned, may no longer be disposed of in municipal or domestic waste. To document this, they have been marked with the following marking:



Because disposal regulations may differ from one country to another within the EU, please contact your supplier if necessary.

11 Technical data

11.1 Power supply

Mains/power connection	230 V, 50 Hz – 60 Hz 120 V, 50 Hz – 60 Hz
Current consumption	230 V: 12.0 A 120 V: 12.0 A
Power consumption	230 V: Maximum 1650 W 120 V: Maximum 1440 W
EMC: Noise emission (radio interference)	230 V: EN 61326-1/EN 55011 – Class A 120 V: CFR 47 FCC Part 15 – Class A
EMC: Noise immunity	EN 61326-1
Overvoltage category	II
Degree of pollution	2

11.2 Weight/dimensions

Dimensions	Width: 73.7 cm (29.02 in) Depth: 70.7 cm (27.83 in) Height: 40.3 cm (15.87 in)
Weight without rotor	139 kg (306.44 lb)

Rotor weights:		Accessories without caps:	
S-4x1000	5300 g	High-Capacity Bucket	870 g
		Plate/Tube Bucket	895 g
		Round bucket	615 g
S-4xUniversal-Large	5220 g	Bucket	890 g
S-4x750	5100 g	Round bucket	605 g
		DWP bucket	700 g
F-6x50	3300 g		
FA-48x2	2500 g		
FA-20x5	2800 g		

11.3 Noise level

The noise level was measured frontally in a sound measuring chamber with accuracy class 1 (DIN EN ISO 3745) at a distance of 1 m from the device and at lab bench height.

	Swing-bucket rotor	Fixed-angle rotor
Noise level at maximum rotor speed	< 60 dB(A)	< 67 dB(A)
	< 55 dB(A) (S-4×Universal-Large)	< 61 dB(A) (FA-6×50)

11.4 Ambient conditions

Environment	For indoor use only
Ambient temperature	10 °C – 40 °C
Relative humidity	10 % – 75 %, non-condensing
Atmospheric pressure	79.5 kPa – 106 kPa Use up to a height of 2 000 m above sea level.

11.5 Application parameters

Cycle time	10 s – 99:59 h, infinite (∞), <ul style="list-style-type: none"> • 10 s – 2 min: can be set in increments of 10 s • 2 min – 10 min: can be set in increments of 30 s • 10 min – 99:59 h: can be set in increments of 1 min
Temperature	-11 °C – 40 °C
Relative centrifugal force	$1 \times g$ – $21\,194 \times g$ <ul style="list-style-type: none"> • $1 \times g$ – $3\,000 \times g$: can be set in increments of $10 \times g$ • $3\,000 \times g$ – $21\,194 \times g$: can be set in increments of $100 \times g$
Rotational speed	100 rpm – 13700 rpm <ul style="list-style-type: none"> • 100 rpm – 5000 rpm: can be set in increments of 10 rpm • 5000 rpm – 13700 rpm: can be set in increments of 100 rpm
Maximum load	Fixed-angle rotor: 6×50 mL Swing-bucket rotors: $4 \times 1\,000$ mL
Maximum kinetic energy	56000J
Permitted density of the material for centrifuging (at maximum g -force (rcf) or rotational speed (rpm) and maximum load)	1.2 g/mL
Inspection obligation in Germany	yes

11.6 Acceleration and deceleration times

The following table shows the approximate acceleration and deceleration times according to DIN 58970 for the rotors of the Centrifuge 5920 R. The details were determined with the rotor at maximum load (for swing-bucket rotors with round bucket). Fluctuations may occur depending on the condition of the device and the load.

Level 9: highest acceleration or strongest brake respectively

Level 0: little acceleration or unbraked deceleration respectively

Rotor		0	1	2	3	4	5	6	7	8	9
S-4xUniversal-Large 120 V devices	Acceleration time	565 s	404 s	258 s	176 s	129 s	101 s	91 s	80 s	74 s	67 s
	Deceleration time	1055 s	577 s	402 s	215 s	150 s	106 s	91 s	74 s	65 s	53 s
	Tolerance	±5 %*									
S-4xUniversal-Large 230 V devices	Acceleration time	579 s	413 s	264 s	178 s	129 s	95 s	95 s	69 s	61 s	52 s
	Deceleration time	1128 s	615 s	366 s	218 s	149 s	105 s	88 s	72 s	62 s	50 s
	Tolerance	±5 %*									
S-4x1000	Acceleration time	445 s	281 s	191 s	127 s	92 s	69 s	61 s	55 s	49 s	45 s
	Deceleration time	1000 s	440 s	240 s	155 s	110 s	78 s	68 s	57 s	48 s	40 s
	Tolerance	–	–	±5 %*							
S-4x750	Acceleration time	410 s	261 s	187 s	123 s	92 s	72 s	59 s	51 s	46 s	42 s
	Deceleration time	1049 s	416 s	216 s	154 s	109 s	84 s	64 s	54 s	46 s	37 s
	Tolerance	–	–	±5 %*							
FA-6x50	Acceleration time	319 s	212 s	148 s	101 s	73 s	53 s	46 s	38 s	34 s	28 s
	Deceleration time	857 s	334 s	214 s	153 s	107 s	77 s	66 s	51 s	43 s	32 s
	Tolerance	–	–	±5 %*							
FA-48x2	Acceleration time	254 s	171 s	120 s	81 s	60 s	44 s	38 s	32 s	28 s	23 s
	Deceleration time	680 s	231 s	152 s	109 s	80 s	57 s	47 s	40 s	34 s	26 s
	Tolerance	–	–	±5 %*							

Rotor		0	1	2	3	4	5	6	7	8	9
FA-20x5	Acceleration time	307 s	208 s	145 s	99 s	72 s	52 s	45 s	37 s	32 s	26 s
	Deceleration time	815 s	292 s	193 s	136 s	97 s	71 s	59 s	47 s	40 s	31 s
	Tolerance	–	–	±5 %*							

* 5 s minimum

11.7 Service life for accessories



CAUTION! Danger due to material fatigue.

When the service life is exceeded, it cannot be guaranteed that the material of the rotors and accessories will withstand the stresses during centrifugation.

- ▶ Do not use any accessories which have exceeded their maximum service life.

Eppendorf states the maximum service life of the rotors and accessories both in years and in the maximum number of cycles. The decisive factor for the service life is which case occurs first, usually this is the number of years in operation.

Each centrifugation run during which the rotor is accelerated and braked is counted as a cycle independent of the speed and the duration of the centrifugation run.

Rotor	Maximum service life after initial setup	
S-4xUniversal-Large	50 000 cycles	7 years
S-4x1000	100 000 cycles	15 years
S-4x1000 with High-Capacity Bucket	75 000 cycles	10 years
S-4x750	100 000 cycles	15 years
FA-6x50	100 000 cycles	15 years
FA-48x2	100 000 cycles	15 years
FA-20x5	100 000 cycles	15 years

All other rotors and rotor lids can be used during the entire service life of the centrifuge if the following conditions are met:

- proper use
- recommended maintenance
- undamaged condition

Accessories	Maximum service life after initial setup	
Rotor lid of polycarbonate (PC), polypropylene (PP) or polyetherimide (PEI)	–	3 years
QuickLock rotor lid		3 years
Seals in the QuickLock rotor lid	50 autoclaving cycles	–
Caps of polycarbonate (PC), polypropylene (PP) or polyetherimide (PEI)	50 autoclaving cycles	3 years
Adapter	–	1 year

The date of manufacture is stamped on the rotors and buckets in the format *03/15* or *03/2015* (= March 2015). On the inside of the plastic-rotor lids and aerosol-tight caps, the date of manufacture is stamped in the form of a clock ⌚.

Measures to ensure aerosol tightness:

- ▶ Replace the seal of QuickLock rotor lids after 50 autoclaving cycles.
- ▶ Replace aerosol-tight caps after 50 autoclaving cycles.

12 Rotors for the Centrifuge 5920 R



Eppendorf centrifuges may only be operated with rotors that are intended for use with the corresponding centrifuge.

- ▶ Only use rotors that are intended for use with the corresponding centrifuge.



Please note the manufacturer's information on the centrifugation resistance of the sample tubes used (maximum *g*-force).



For ordering information, refer to the English and German version of the operating manual.

Technical data of the rotors and adapters and the order numbers of the adapters can be found in chapter *Rotors for the Centrifuge 5920 R* of the English version of the operating manual.

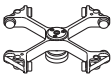
12.1 Rotor S-4xUniversal-Large

12.1.1 Swing-bucket rotor S-4xUniversal-Large with 4 aerosol-tight buckets

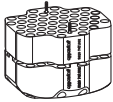

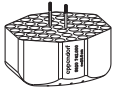





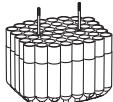

			Max. <i>g</i> -force: 120 V: 4198 × <i>g</i> 230 V: 4402 × <i>g</i>
			Max. speed: 120 V: 4150 rpm 230 V: 4250 rpm
Rotor	Universal Bucket and aerosol-tight cap		Max. load per bucket (adapter, tube and contents): 1150 g
S-4xUniversal-Large			



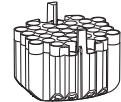

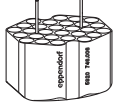

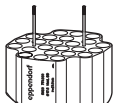

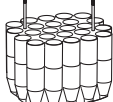

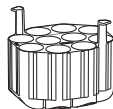
Vessel	Vessel Capacity Number per adapter/rotor	Adapter Order no. (international)	Bottom shape Tube diameter Max. tube length with/without cap	Max. <i>g</i> -force Max. speed Radius	
				120 V	230 V
	Micro test tube 1.5 mL/2 mL 92/368	 5920 747.002	open Ø 11 mm 39 mm	Top: 3158 × <i>g</i> Bottom: 3947 × <i>g</i> 4150 rpm Top: 16.4 cm Bottom: 20.5 cm	Top: 3312 × <i>g</i> Bottom: 4140 × <i>g</i> 4250 rpm Top: 16.4 cm Bottom: 20.5 cm
	Round-bottom tube Ø 12 mm × 75 mm 51/204	 5920 742.000	round Ø 12 mm 82 mm/113 mm	3947 × <i>g</i> 4150 rpm 20.5 cm	4140 × <i>g</i> 4250 rpm 20.5 cm

Rotors for the Centrifuge 5920 R

Centrifuge 5920 R



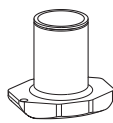

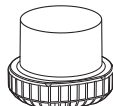
English (EN)

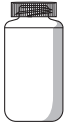
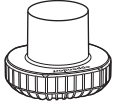

Vessel	Vessel Capacity Number per adapter/rotor	Adapter Order no. (international)	Bottom shape Tube diameter Max. tube length with/ without cap	Max. <i>g</i> -force Max. speed Radius	
				120 V	230 V
	Round-bottom tube 4 mL – 8 mL (Ø 13 × 75 mm – 100 mm) 49/196	 5920 739.000	round Ø 13 mm 107 mm/ 110 mm	3947 × <i>g</i> 4150 rpm 20.5 cm	4140 × <i>g</i> 4250 rpm 20.5 cm
	Eppendorf Tubes 5 mL 24/96	 5920 736.000 (without upper part)	conical Ø 17 mm 123 mm/ 131 mm	4198 × <i>g</i> 4150 rpm 21.8 cm	4402 × <i>g</i> 4250 rpm 21.8 cm
	Round-bottom tube 7.5 mL – 12 mL (Ø 16 × 75 mm – 100 mm) 37/148	 5920 738.003	round Ø 16 mm 106 mm/ 110 mm	3928 × <i>g</i> 4150 rpm 20.4 cm	4120 × <i>g</i> 4250 rpm 20.4 cm
	Vessel 9 mL (Ø 17.5 mm × 100 mm) 28/112	 5920 746.006	round Ø 17.5 mm 130 mm/ 136 mm	4024 × <i>g</i> 4150 rpm 20.9 cm	4221 × <i>g</i> 4250 rpm 20.9 cm
	Round-bottom tube 14 mL 24/96	 5920 751.000	round Ø 17.5 mm 120 mm/ 123 mm	4043 × <i>g</i> 4150 rpm 21.0 cm	4240 × <i>g</i> 4250 rpm 21.0 cm
	Conical tube 15 mL 24/96	 5920 736.000	conical Ø 17 mm 123 mm/ 131 mm	4198 × <i>g</i> 4150 rpm 21.8 cm	4002 × <i>g</i> 4250 rpm 21.8 cm

Vessel	Vessel Capacity Number per adapter/rotor	Adapter Order no. (international)	Bottom shape Tube diameter Max. tube length with/ without cap	Max. g-force Max. speed Radius	
				120 V	230 V
	Conical tube 50 mL 10/40	 5920 735.004	conical Ø 29 mm 125 mm/ 131 mm	4101 × g 4150 rpm 21.3 cm	4301 × g 4250 rpm 21.3 cm
	Conical tube (skirted) 50 mL 7/28	 5920 748.009	Skirted bottom Ø 29 mm 121 mm/ 141 mm	3793 × g 4150 rpm 19.7 cm	3978 × g 4250 rpm 19.7 cm
	Round-bottom tube 50 mL 12/48	 5920 753.002	round Ø 29 mm 121 mm/ 132 mm	3966 × g 4150 rpm 20.6 cm	4160 × g 4250 rpm 20.6 cm
	Wide-neck bottle/conical tube 250 mL flat 175 mL – 225 mL conical 2/8	 5920 740.008	flat For conical tubes, additionally insert the adapter of the manufacturer. Ø 62 mm 126 mm/ 133 mm	3909 × g 4150 rpm 20.3 cm	4099 × g 4250 rpm 20.3 cm
	Conical tube 175 mL – 250 mL 1/4	 5920 750.003	conical Ø 62 mm 144 mm/ 171 mm	4005 × g 4150 rpm 20.8 cm	4200 × g 4250 rpm 20.8 cm
	Conical tube 500 mL Corning 1/4	 5920 744.003	conical Ø 96 mm 148 mm/ 160 mm	4005 × g 4150 rpm 20.8 cm	4200 × g 4250 rpm 20.8 cm

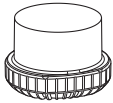



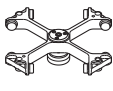

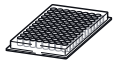

Rotors for the Centrifuge 5920 R

Centrifuge 5920 R
English (EN)

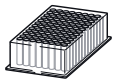
Vessel	Vessel Capacity Number per adapter/rotor	Adapter Order no. (international)	Bottom shape Tube diameter Max. tube length with/ without cap	Max. g-force Max. speed Radius	
				120 V	230 V
	Wide-neck bottle 500 mL 1/4	 5920 745.000	flat Ø 69.5 mm 143 mm/ 168 mm	3966 × g 4150 rpm 20.6 cm	4160 × g 4250 rpm 20.6 cm
	Wide-neck bottle 750 mL 1/4	 5920 741.004	flat Ø 102 mm 143 mm/ 166 mm	3889 × g 4150 rpm 20.2 cm	4079 × g 4250 rpm 20.2 cm
	ABI Microfluidic Cards 3/12	 5920 749.005	flat -/153 mm	3851 × g 4150 rpm 20.0 cm	4039 × g 4250 rpm 20.0 cm

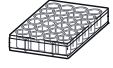
			Max. <i>g</i> -force: 120 V: 3755 × <i>g</i> 230 V: 3938 × <i>g</i>
			Max. speed: 120 V: 4150 rpm 230 V: 4250 rpm
Rotor	Universal Bucket with plate carrier	Max. load per bucket (adapter, tube and contents): 1150 g	
S-4xUniversal-Large			

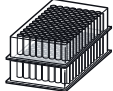
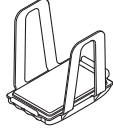

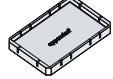

For centrifugation of the following plate and vessels always use the plate carrier. Use plate carrier and adapter if necessary.

Plate/tube	Plate Capacity Number per adapter/rotor	Adapter Order no. (international)	Bottom shape Max. tube length with/ without cap	Max. <i>g</i> -force Max. speed Radius	
				120 V	230 V
	Microplate 96/384 wells 6/24	 5920 737.007	flat 110 mm/ 116 mm	3755 × <i>g</i> 4150 rpm 19.5 cm	3938 × <i>g</i> 4250 rpm 19.5 cm
	Deepwell plate 96 wells 2/8	 5920 737.007	flat 110 mm/ 116 mm	3755 × <i>g</i> 4150 rpm 19.5 cm	3938 × <i>g</i> 4250 rpm 19.5 cm
	Cell culture plate 1/4	 5920 737.007	flat 110 mm/ 116 mm	3755 × <i>g</i> 4150 rpm 19.5 cm	3938 × <i>g</i> 4250 rpm 19.5 cm
	Kit 1/4	 5920 737.007	flat 110 mm/ 116 mm	3755 × <i>g</i> 4150 rpm 19.5 cm	3938 × <i>g</i> 4250 rpm 19.5 cm
	PCR plate 384 wells 1/4	Plate carrier +  5825 713.001	flat 110 mm/ 116 mm	3581 × <i>g</i> 4150 rpm 18.6 cm	3756 × <i>g</i> 4250 rpm 18.6 cm

Rotors for the Centrifuge 5920 R

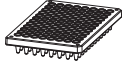
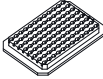
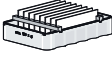

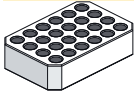
Centrifuge 5920 R

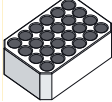



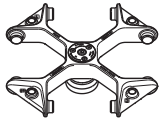

English (EN)

Plate/tube	Plate Capacity Number per adapter/rotor	Adapter Order no. (international)	Bottom shape Max. tube length with/ without cap	Max. <i>g</i> -force Max. speed Radius	
				120 V	230 V
	PCR plate 96 wells 1/4	Plate carrier +  5825 711.009	conical 110 mm/ 116 mm	3620 × <i>g</i> 4150 rpm 18.8 cm	3796 × <i>g</i> 4250 rpm 18.8 cm
Slides	CombiSlide 12 slides 12/48	Plate carrier +  5825 706.005	flat 110 mm/ 116 mm	3678 × <i>g</i> 4150 rpm 19.1 cm	3857 × <i>g</i> 4250 rpm 19.1 cm
	IsoRack 24 × 0.5 mL micro test tubes 1/4	Plate carrier +  5825 708.008	open Ø 6 mm 110 mm/ 116 mm	3620 × <i>g</i> 4150 rpm 18.8 cm	3796 × <i>g</i> 4250 rpm 18.8 cm
	IsoRack 24 × 1.5/2 mL micro test tubes 1/4	Plate carrier +  5825 709.004	open Ø 11 mm 110 mm/ 116 mm	3543 × <i>g</i> 4150 rpm 18.4 cm	3716 × <i>g</i> 4250 rpm 18.4 cm

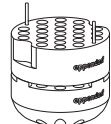
12.2 Rotor S-4x1000

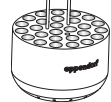

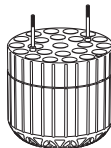

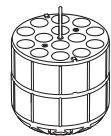





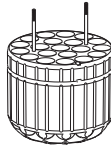

12.2.1 Swing-bucket rotor S-4x1000 with 4 aerosol-tight round buckets 1000 mL

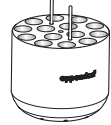



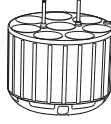

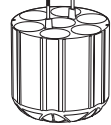

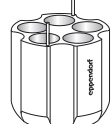

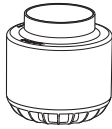
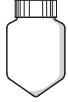
			Max. <i>g</i> -force: 3428 × <i>g</i>
			Max. rotational speed: 3700 rpm
Rotor S-4x1000	Round bucket 1000 mL	Aerosol-tight cap	Max. load per bucket (adapter, tube and contents): 1340 g

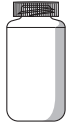
Tube	Tube Capacity Number per adapter/rotor	Adapter Order no. (international)	Bottom shape Tube diameter Max. tube length with/without cap	Max. <i>g</i> -force Max. rotational speed Radius
	Micro test tube 1.5 mL/2 mL 50/200	 5825 740.009	Open Ø 11 mm 39 mm	Top: 2648 × <i>g</i> Bottom: 3352 × <i>g</i> 3700 rpm Top: 17.3 cm Bottom: 21,9 cm
	Round-bottom tube Ø 12 mm × 75 mm 27/108	 5825 747.003	Round Ø 12 mm 108 mm/115 mm	3229 × <i>g</i> 3700 rpm 21.1 cm
	Round-bottom tube 4 mL – 8 mL (Ø 13 mm × 75 mm – 100 mm) 23/92	 5825 738.004	Round Ø 13 mm 113 mm/121 mm	3214 × <i>g</i> 3700 rpm 21.0 cm
	Eppendorf Tubes 5 mL 14/56	 5825 734.009 (without upper part)	Conical Ø 17 mm 150 mm/161 mm	3428 × <i>g</i> 3700 rpm 22.4 cm

Rotors for the Centrifuge 5920 R

Centrifuge 5920 R
English (EN)

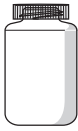

Tube	Tube Capacity Number per adapter/rotor	Adapter Order no. (international)	Bottom shape Tube diameter Max. tube length with/without cap	Max. <i>g</i> -force Max. rotational speed Radius
	Round-bottom tube 5.5 mL – 12 mL (Ø 16 mm × 75 mm – 100 mm) 20/80	 5825 736.001	Round Ø 16 mm 140 mm/140 mm	3229 × <i>g</i> 3700 rpm 21.1 cm
	Tube 9 mL (Ø 17.5 mm × 100 mm) 20/80	 5825 743.008	Round Ø 17.5 mm 112 mm/117 mm	3214 × <i>g</i> 3700 rpm 21.0 cm
	Round-bottom tube 14 mL 14/56	 5825 748.000	Round Ø 17.5 mm 112 mm/117 mm	3214 × <i>g</i> 3700 rpm 21.0 cm
	Conical tube 15 mL 14/56	 5825 734.009	Conical Ø 17 mm 150 mm/161 mm	3428 × <i>g</i> 3700 rpm 22.4 cm
	Universal vessel 30 mL 5825 755.006	 5825 755.006	Conical Ø 25 mm 139 mm/144 mm	3245 × <i>g</i> 3700 rpm 21.2 cm
	Conical tube 50 mL 7/28	 5825 733.002	Conical Ø 29 mm 150 mm/156 mm	3413 × <i>g</i> 3700 rpm 22.3 cm
	Conical tube (skirted) 50 mL 5/20	 5825 732.006	Conical Ø 29 mm 147 mm/151 mm	3199 × <i>g</i> 3700 rpm 20.9 cm

Tube	Tube Capacity Number per adapter/rotor	Adapter Order no. (international)	Bottom shape Tube diameter Max. tube length with/without cap	Max. <i>g</i> -force Max. rotational speed Radius
	Wide-neck bottle/ conical tube 175 mL – 250 mL 250 mL Corning 1/4	 5825 741.005	Flat For conical tubes, additionally insert the adapter of the manufacturer. Ø 62 mm 156 mm/176 mm	$3275 \times g$ 3700 rpm 21,4 cm
	Conical tube 500 mL Corning 1/4	 5825 745.000	Conical Ø 96 mm 167 mm/167 mm	$3336 \times g$ 3700 rpm 21.8 cm
	Wide-neck bottle 500 mL 1/4	 5920 703.005	Flat 69.5 mm 183 mm/183 mm	$3382 \times g$ 3700 rpm 22.1 cm
	TPP bioreactor 600 mL 1/4	 5920 701.002	Conical Ø 98 mm 181 mm/181 mm	$3428 \times g$ 3700 rpm 22,4 mm
	Wide-neck bottle 750 mL 1/4	 5825 744.004	Flat Ø 102 mm 181 mm/181 mm	$3306 \times g$ 3700 rpm 21,6 cm
	Wide-neck bottle Nalgene: 3120 1010, 3122 1010 1000 mL 1/4	 5920 700.006	Flat Ø 98 mm (Do not use aerosol-tight cap.)/ 169 mm	$3336 \times g$ 3700 rpm 21.8 cm

Rotors for the Centrifuge 5920 R









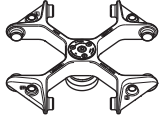
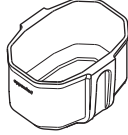

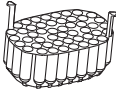
Centrifuge 5920 R

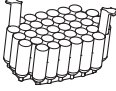
English (EN)

Tube	Tube Capacity Number per adapter/rotor	Adapter Order no. (international)	Bottom shape Tube diameter Max. tube length with/without cap	Max. <i>g</i> -force Max. rotational speed Radius
	TaqMan Array Microfluidic Card 3/12	 5825 759.001		$3199 \times g$ 3700 rpm 20.9 cm

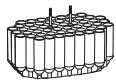

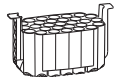
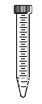
12.2.2 Swing-bucket rotor S-4x1000 with 4 High-Capacity Buckets



		Max. <i>g</i> -force:	3 153 × <i>g</i>
		Max. rotational speed:	3 700 rpm
Rotor S-4x1000	High-Capacity Bucket	Max. load per bucket (adapter, tube and contents):	1 150 g

Tube	Tube Capacity Tubes per adapter/ rotor	Adapter Order no. (international)	Bottom shape Tube diameter Max. tube length	Max. <i>g</i> -force Max. rotational speed Radius
	Round-bottom tube 4 mL – 8 mL (Ø 13 mm × 75 mm – 100 mm) 49/196	 5920 718.002	Round Ø 13 mm 107 mm	3 122 × <i>g</i> 3 700 rpm 20.4 cm
	Round-bottom tube 7.5 mL – 12 mL (Ø 16 mm × 75 mm – 100 mm) 36/44	 5920 720.007	Round Ø 16 mm 107 mm	3 046 × <i>g</i> 3 700 rpm 19.9 cm
	Eppendorf Tubes 5 mL 25/100	 5920 716.000 (without upper part)	Conical Ø 17 mm 57 mm	3 138 × <i>g</i> 3 700 rpm 20.5 cm
	Round-bottom tube Ø 12 mm × 75 mm 52/208	 5920 724.002	Round Ø 12 mm 85 mm	3 122 × <i>g</i> 3 700 rpm 20.4 cm
	Round-bottom tube 14 mL 29/116	 5920 722.000	Round Ø 17.5 mm 14 mm	3 122 × <i>g</i> 3 700 rpm 20.4 cm
	Conical tube 15 mL 27/108	 5920 716.000	Conical Ø 17 mm 121 mm	3 138 × <i>g</i> 3 700 rpm 20.5 cm

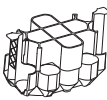



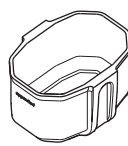

Rotors for the Centrifuge 5920 R

Centrifuge 5920 R
English (EN)

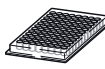
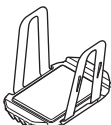
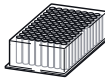
Tube	Tube Capacity Tubes per adapter/ rotor	Adapter Order no. (international)	Bottom shape Tube diameter Max. tube length	Max. <i>g</i> -force Max. rotational speed Radius
	Conical tube 50 mL 13/52	 Adapter cannot be disconnected. 5920 715.003	Conical Ø 29 mm 116 mm	3153 × <i>g</i> 3700 rpm 20.6 cm
	Wide-neck bottle/ conical tube 175 mL – 250 mL 2/8	 5920 717.006	Flat Ø 60 mm 148 mm	3061 × <i>g</i> 3700 rpm 20,0 cm

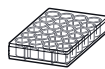

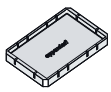

			Max. <i>g</i> -force:	2832 × <i>g</i>
			Max. rotational speed:	3700 rpm
Rotor S-4x1000	High-Capacity Bucket with plate carrier		Max. load per bucket (adapter, tube and contents):	1150 g

Always use the High-Capacity Bucket with plate carrier for centrifugation of the following plates and tubes. Use plate carrier and adapter if necessary.

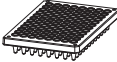
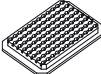

Plate/tube	Plate Capacity Number per adapter/rotor	Adapter Order no. (international)	Bottom shape Max. loading height	Max. <i>g</i> -force Max. rotational speed Radius
	Microplate 96/384 wells 6/24	 5920 729.004	Flat 88 mm	2832 × <i>g</i> 3700 rpm 18.5 cm
	Deepwell plate 96 wells 2/8	 5920 729.004	Flat 88 mm	2832 × <i>g</i> 3700 rpm 18.5 cm
	Cell-culture plate 1/4	 5920 729.004	Flat 88 mm	2832 × <i>g</i> 3700 rpm 18.5 cm
	Kit 1/4	 5920 729.004	Flat 88 mm	2832 × <i>g</i> 3700 rpm 18.5 cm
	PCR plate 384 wells 1/4	Plate carrier +  5825 713.001	Flat 88 mm	2694 × <i>g</i> 3700 rpm 17,6 cm

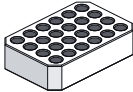

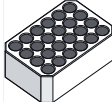



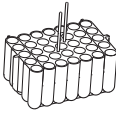

Rotors for the Centrifuge 5920 R

Centrifuge 5920 R
English (EN)

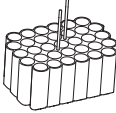
Plate/tube	Plate Capacity Number per adapter/rotor	Adapter Order no. (international)	Bottom shape Max. loading height	Max. <i>g</i> -force Max. rotational speed Radius
	PCR plate 96 wells 1/4	Plate carrier +  5825 711.009	Conical 88 mm	$2357 \times g$ 3700 rpm 17.8 cm
Slide	CombiSlide 12 slides 12/48	Plate carrier +  5825 706.005	Flat 88 mm	$2770 \times g$ 3700 rpm 18.1 cm
	IsoRack 24 × 0.5 mL micro test tubes 1/4	Plate carrier +  5825 708.008	Open Ø 6 mm 88 mm	$2724 \times g$ 3700 rpm 17.8 cm
	IsoRack 24 × 1.5/2 mL micro test tubes 1/4	Plate carrier +  5825 709.004	Open Ø 11 mm 88 mm	$2663 \times g$ 3700 rpm 17.4 cm







12.2.3 Swing-bucket rotor S-4x1000 with 4 aerosol-tight plates/tube buckets



			Max. <i>g</i> -force: 3076 × <i>g</i>
			Max. speed: 3700 rpm
Rotor S-4x1000	Plate/tube bucket	Aerosol-tight cap	Max. load per bucket (adapter, tube and contents): 970 g

Tube	Tube Capacity Tubes per adapter/ rotor	Adapter Order no. (international)	Bottom shape Tube diameter Max. tube length with/without cap	Max. <i>g</i> -force Max. speed Radius
	Round-bottom tube 4 mL – 8 mL (Ø 13 mm × 75 mm – 100 mm 35/140	 5920 706.004	round Ø 13 mm 108 mm/109 mm	3076 × <i>g</i> 3700 rpm 20.1 cm
	Round-bottom tube 7.5 mL – 12 mL 33/132	 5920 707.000	round Ø 16 mm 109 mm/109 mm	3061 × <i>g</i> 3700 rpm 20,0 cm
	Tube 9 mL (Ø 17.5 mm × 75 mm) 28/112	 5920 708.007	round Ø 17,5 mm 109 mm/109 mm	3061 × <i>g</i> 3700 rpm 20,0 cm
	Tube 9 mL (Ø 17.5 mm × 100 mm) 21/84	 5920 708.007 Do not use the outer bores.	round Ø 17,5 mm 109 mm/109 mm	3061 × <i>g</i> 3700 rpm 20,0 cm
	Eppendorf Tubes 5 mL 22/88	 5920 710.001 without upper part	conical Ø 17 mm 65 mm/65 mm	3076 × <i>g</i> 3700 rpm 20.1 cm

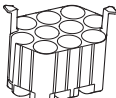

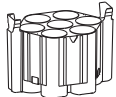



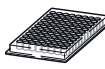

Rotors for the Centrifuge 5920 R

Centrifuge 5920 R
English (EN)

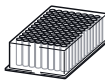
Tube	Tube Capacity Tubes per adapter/ rotor	Adapter Order no. (international)	Bottom shape Tube diameter Max. tube length with/without cap	Max. <i>g</i> -force Max. speed Radius
	Conical tube 15 mL 22/88	 5920 710.001	conical Ø 17 mm (Do not use aerosol-tight cap.)/ 121 mm	3076 × <i>g</i> 3700 rpm 20.1 cm
	Conical tube 15 mL 16/64	 5920 712.004	conical Ø 17 mm 121 mm/123 mm	3076 × <i>g</i> 3700 rpm 20.1 cm
	Conical tube 50 mL 10/40	 5920 709.003	conical Ø 29 mm (Do not use aerosol-tight cap.)/ 121 mm	3076 × <i>g</i> 3700 rpm 20.1 cm
	Conical tube 50 mL 7/28	 5920 711.008	conical Ø 29 mm 121 mm/121 mm	3076 × <i>g</i> 3700 rpm 20.1 cm

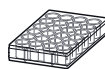

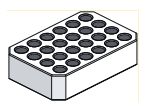

			Max. <i>g</i> -force: 3076 × <i>g</i>
			Max. speed: 3700 rpm
Rotor S-4x1000	Plate/Tube Bucket with plate carrier	Aerosol-tight cap	Max. load per bucket (adapter, tube and contents): 970 g

Always use the Plate/Tube Bucket with plate carrier for the centrifugation of the following plates and tubes. Use plate carrier and adapter if necessary.

Plate	Plate Capacity	Adapter Order no. (international)	Bottom shape	Max. <i>g</i>-force
	Number per adapter/rotor		Max. loading height	Max. speed
				Radius
	Microplate 96/384 wells	 5920 705.008	flat	3030 × <i>g</i> 3700 rpm
	10/40		91 mm/104 mm	19,8 cm
	Deepwell plate 96 wells	 5920 705.008	flat	3030 × <i>g</i> 3700 rpm
	2/8		91 mm/104 mm	19,8 cm
	Cell culture plate	 5920 705.008	flat	3030 × <i>g</i> 3700 rpm
	2/8		91 mm/104 mm	19,8 cm
	Kit	 5920 705.008	flat	3030 × <i>g</i> 3700 rpm
	1/4		91 mm/104 mm	19,8 cm
	IsoRack 24 × 0.5 mL micro test tubes	Plate carrier +  5825 708.008	open Ø 6 mm	3015 × <i>g</i> 3700 rpm
	1/4		47 mm/60 mm	19,1 cm

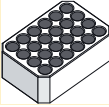
Rotors for the Centrifuge 5920 R

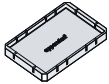
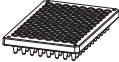
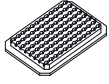
Centrifuge 5920 R
English (EN)

Plate	Plate Capacity Number per adapter/rotor	Adapter Order no. (international)	Bottom shape Max. loading height	Max. <i>g</i> -force Max. speed Radius
	IsoRack 24 × 1.5/2 mL micro test tubes 1/4	Plate carrier +  5825 709.004	open Ø 11 mm 47 mm/60 mm	2862 × <i>g</i> 3700 rpm 18.7 cm
	PCR plate 384 wells 1/4	Plate carrier +  5825 713.001	flat 91 mm/104 mm	2893 × <i>g</i> 3700 rpm 18,9 cm
	PCR plate 96 wells 1/4	Plate carrier +  5825 711.009	conical 91 mm/104 mm	2939 × <i>g</i> 3700 rpm 19.2 cm
Slides	CombiSlide 12 slides 12/48	Plate carrier +  5825 706.005	flat 47 mm/60 mm	2985 × <i>g</i> 3700 rpm 19,5 cm



12.3 Rotor S-4x750



12.3.1 Swing-bucket rotor S-4x750 with 4 750 mL round buckets



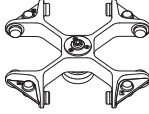



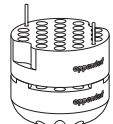

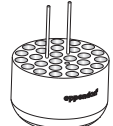
Impact of rotational speed on temperature with the 120 V device model

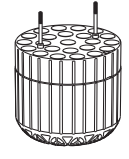

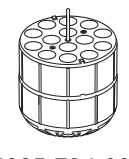

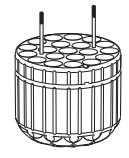

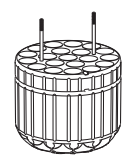

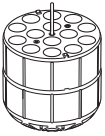

To maintain a temperature of 4 °C with an ambient temperature of 23 °C, rotational speed must be reduced to 4400 rpm.

Rotational speed	Temperature
4400 rpm	4 °C
4700 rpm	6 °C

			Max. <i>g</i> -force:	100 V: 4031 × <i>g</i>	120 V/230 V: 4816 × <i>g</i>
			Max. rotational speed:	100 V: 4300 rpm	120 V/230 V: 4700 rpm
Rotor S-4x750	Round bucket 750 mL	Aerosol-tight cap	Max. load per bucket (adapter, tube and contents):	1000 g	1000 g

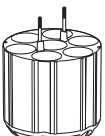

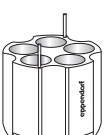

Tube	Tube Capacity	Adapter	Bottom shape	Max. <i>g</i> -force	
				Max. rotational speed	
	Tubes per adapter/rotor	Order no. (international)	Tube diameter	100 V	120 V/230 V
			Max. tube length with/without cap	Radius	Radius
	Micro test tube 1.5 mL/2 mL 50/200	 5825 740.009	Open Ø 11 mm 39 mm	Top: 3059 × <i>g</i> Bottom: 4010 × <i>g</i> 4300 rpm Top: 14.8 cm Bottom: 19.4 cm	Top: 3655 × <i>g</i> Bottom: 4791 × <i>g</i> 4700 rpm Top: 14.8 cm Bottom: 19.4 cm
	Round-bottom tube Ø 12 mm × 75 mm 27/108	 5825 747.003	Round Ø 12 mm 113 mm/ 120 mm	3845 × <i>g</i> 4300 rpm 18.6 cm	4594 × <i>g</i> 4700 rpm 18.6 cm

Tube	Tube Capacity	Adapter	Bottom shape	Max. g-force		
				Max. rotational speed		
	Tubes per adapter/rotor	Order no. (international)	Tube diameter	Max. tube length with/without cap	100 V	120 V/230 V
	Round-bottom tube	 5825 738.004	Round		3824 × g	4569 × g
	4 mL – 8 mL (Ø 13 mm × 75 mm – 100 mm)		Ø 13 mm		4300 rpm	4700 rpm
	23/92		113 mm/ 121 mm	18.5 cm	18.5 cm	
	Eppendorf Tubes	 5825 734.009 (without upper part)	Conical		3886 × g	4643 × g
	5 mL		Ø 17 mm		4300 rpm	4700 rpm
	14/56		65 mm	18.8 cm	18.8 cm	
	Round-bottom tube	 5825 736.001	Round		3845 × g	4594 × g
	7.5 mL – 12 mL (Ø 16 mm × 75 mm – 100 mm)		Ø 16 mm		4300 rpm	4700 rpm
	20/80		120 mm/ 125 mm	18.6 cm	18.6 cm	
	Round-bottom tube	 5825 736.001	Round		3845 × g	4594 × g
	8 mL – 16 mL		Ø 16 mm		4300 rpm	4700 rpm
	7/28 (Load inner bores only (see p. 35))		(Do not use the aerosol-tight cap.)/125 mm	18.6 cm	18.6 cm	
	Tube	 5825 743.008	Round		3824 × g	4569 × g
	9 mL (Ø 17.5 mm × 100 mm)		Ø 17.5 mm		4300 rpm	4700 rpm
	20/80		112 mm/ 117 mm	18.5 cm	18.5 cm	

Tube	Tube Capacity	Adapter	Bottom shape	Max. <i>g</i> -force	
				Max. rotational speed	
	Tubes per adapter/rotor	Order no. (international)	Tube diameter	Radius	
			Max. tube length with/without cap	100 V	120 V/230 V
	Round-bottom tube 14 mL 14/56	 5825 748.000	Round Ø 17.5 mm 106 mm	3824 × <i>g</i> 4300 rpm 18.5 cm	4569 × <i>g</i> 4700 rpm 18.5 cm
	Conical tube 15 mL 14/56	 5825 734.009	Conical Ø 17 mm × 104 mm 120 mm/ 125 mm	3886 × <i>g</i> 4300 rpm 18.8 cm	4643 × <i>g</i> 4700 rpm 18.8 cm
	Conical tube (skirted) 30 mL 14/56	 5825 755.006	Conical Ø 25 mm 114 mm/ 119 mm	3742 × <i>g</i> 4300 rpm 18.1 cm	4470 × <i>g</i> 4700 rpm 18.1 cm
	Conical tube 50 mL 7/28	 5825 733.002	Conical Ø 29 mm 116 mm/ 122 mm	3866 × <i>g</i> 4300 rpm 18.7 cm	4618 × <i>g</i> 4700 rpm 18.7 cm
	Conical tube (skirted) 50 mL 5/20	 5825 732.006	Conical Ø 29 mm 116 mm/ 122 mm	3659 × <i>g</i> 4300 rpm 17.7 cm	4371 × <i>g</i> 4700 rpm 17.7 cm
	Wide-neck bottle/conical tube 175 mL – 250 mL 1/4	 5825 741.005	Flat Ø 62 mm 125 mm/ 145 mm	3786 × <i>g</i> 4300 rpm 18.3 cm	4519 × <i>g</i> 4700 rpm 18.3 cm

Rotors for the Centrifuge 5920 R

Centrifuge 5920 R
English (EN)

Tube	Tube Capacity Tubes per adapter/rotor	Adapter Order no. (international)	Bottom shape Tube diameter Max. tube length with/without cap	Max. g-force Max. rotational speed Radius	
				100 V	120 V/230 V
	Conical tube 500 mL Corning 1/4	 5825 745.000	Conical Ø 96 mm (Do not use the aerosol-tight cap.)/147 mm	3845 × <i>g</i> 4300 rpm 18.6 cm	4594 × <i>g</i> 4700 rpm 18.6 cm
	Wide-neck bottle 750 mL 1/4	 5825 744.004	Flat Ø 102 mm 150 mm/ 150 mm	3824 × <i>g</i> 4300 rpm 18.5 cm	4569 × <i>g</i> 4700 rpm 18.5 cm

12.3.2 Swing-bucket rotor S-4x750 with 4 plate buckets

For centrifugation of the following plate and vessels always use the plate carrier. Use plate carrier and adapter if necessary.











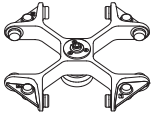

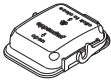
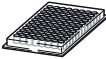

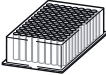
			Max. <i>g</i> -force: 3976 × <i>g</i>
			Max. rotational speed: 4700 rpm
Rotor S-4x750	Plate bucket (always use with a plate carrier)	Aerosol-tight cap	Max. load per bucket (adapter, plate and contents): 450 g

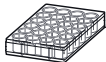
Plate	Plate Capacity	Adapter	Bottom shape	Max. <i>g</i> -force
				Max. rotational speed
	Number per adapter/rotor	Order no. (international)	Max. loading height	Radius
	Microplate 96/384 wells 4/16	 5820 756.004	Flat 47 mm/64 mm	3976 × <i>g</i> 4700 rpm 16.1 cm
	Deepwell plate 96 wells 1/4	 5820 756.004	Flat 47 mm/64 mm	3976 × <i>g</i> 4700 rpm 16.1 cm
	Cell-culture plate 2/8	 5820 756.004	Flat 47 mm/64 mm	3976 × <i>g</i> 4700 rpm 16.1 cm
	Kit 1/4	 5820 756.004	Flat 47 mm/64 mm	3976 × <i>g</i> 4700 rpm 16.1 cm
	IsoRack 24 × 0.5 mL micro test tubes 1/4	Plate carrier +  5825 708.008	Open Ø 6 mm 47 mm/64 mm	3803 × <i>g</i> 4700 rpm 15.4 cm

Rotors for the Centrifuge 5920 R

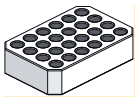

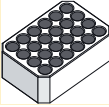

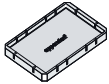
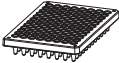
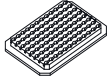
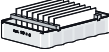



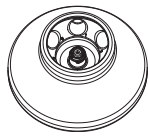

Centrifuge 5920 R
English (EN)

Plate	Plate Capacity	Adapter	Bottom shape	Max. <i>g</i> -force
				Max. rotational speed
	Number per adapter/rotor	Order no. (international)	Max. loading height	Radius
	IsoRack 24 × 1.5/2 mL micro test tubes	Plate carrier +  5825 709.004	Open Ø 11 mm 47 mm/64 mm	3704 × <i>g</i> 4700 rpm 15.0 cm
	PCR plate 384 wells	Plate carrier +  5825 713.001	Flat 47 mm/64 mm	3754 × <i>g</i> 4700 rpm 15.2 cm
	PCR plate 96 wells	Plate carrier +  5825 711.009	Conical 47 mm/64 mm	3803 × <i>g</i> 4700 rpm 15.4 cm
Slide	CombiSlide 12 slides	Plate carrier +  5825 706.005	Flat 47 mm/64 mm	3877 × <i>g</i> 4700 rpm 15.7 cm

12.4 Rotor FA-6x50











Aerosol-tight fixed-angle rotor for 6 conical tubes

	Max. <i>g</i> -force:	20130 × <i>g</i>
	Max. rotational speed:	12100 rpm
Rotor FA-6x50	Max. load (adapter, tube and contents):	6 × 75 g

Tube	Tube Capacity Tubes per adapter/ rotor	Adapter Order no. (international)	Bottom shape Tube diameter Max. tube length with rotor lid	Max. <i>g</i> -force Max. rotational speed Radius
	Round-bottom tube 16 mL 1/6	 5820 720.000	Round Ø 18.1 mm 107 mm	19642 × <i>g</i> 12100 rpm 12.0 cm
	Round-bottom tube 2.6 mL – 5 mL (Ø 13 mm × 75 mm) 1/6	 5820 726.008	Round Ø 13.5 mm –	19642 × <i>g</i> 12100 rpm 12.0 cm
	Round-bottom tube 4 mL – 8 mL (Ø 13 mm × 100 mm) 1/6	 5820 725.001	Round Ø 13.5 mm 119 mm	19642 × <i>g</i> 12100 rpm 12.0 cm
	Eppendorf Tubes 5 mL 1/6	 5820 730.005	Conical Ø 17 mm –	19806 × <i>g</i> 12100 rpm 12.1 cm
	Round-bottom tube 5.5 mL – 10 mL (Ø 16 mm × 75 mm) 1/6	 5820 728.000	Round Ø 16 mm –	19642 × <i>g</i> 12100 rpm 12.0 cm

Rotors for the Centrifuge 5920 R





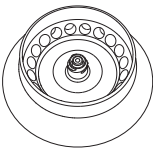

Centrifuge 5920 R
English (EN)

Tube	Tube Capacity Tubes per adapter/ rotor	Adapter Order no. (international)	Bottom shape Tube diameter Max. tube length with rotor lid	Max. <i>g</i> -force Max. rotational speed Radius
	Round-bottom tube 7.5 mL – 12 mL (Ø 16 mm × 100 mm) 1/6	 5820 727.004	Round Ø 16.4 mm 119 mm	19642 × <i>g</i> 12100 rpm 12.0 cm
	Tube 9 mL 1/6	 5820 729.007	Round Ø 16.4 mm 112 mm	19642 × <i>g</i> 12100 rpm 12.0 cm
	Conical tube 15 mL 1/6	 5820 717.009	Conical Ø 17 mm 125 mm	19642 × <i>g</i> 12100 rpm 12.0 cm
	Round-bottom tube 30 mL 1/6	 5820 721.006	Round Ø 25.7 mm 104 mm	17187 × <i>g</i> 12100 rpm 10,5 cm
	Conical tube 35 mL 1/6	 5820 722.002	Conical Ø 28.7 mm 113 mm	18333 × <i>g</i> 12100 rpm 11.2 cm
	Conical tube 50 mL 1/6	–	Conical Ø 29.6 mm 127 mm	20133 × <i>g</i> 12100 rpm 12.3 cm

12.5 Rotor FA-20x5

Aerosol-tight fixed-angle rotor for 20 tubes

	Max. <i>g</i> -force:	20913 × <i>g</i>
	Max. rotational speed:	13100 rpm
Rotor FA-20x5	Max. load (adapter, tube and contents):	20 × 9.5 g

Tube	Tube Capacity Tubes per adapter/ rotor	Adapter Order no. (international)	Bottom shape Tube diameter	Max. g-force Max. rotational speed Radius
	HPLC vial 1/20	 5820 770.007	Ø 11 mm	17076 × g 13100 rpm 8.9 cm
	Cryo tube 1.0 mL/2.0 mL 1/20	 5820 769.009	Ø 13 mm	18802 × g 13100 rpm 9.8 cm
	Micro test tube 1.5 mL/2.0 mL 1/20	 5820 768.002	Open Ø 11 mm	18227 × g 13100 rpm 9.5 cm
	Eppendorf Tubes 5 mL -/20		Conical Ø 17 mm	20913 × g 13100 rpm 10,9 cm







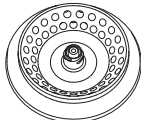

Rotors for the Centrifuge 5920 R

Centrifuge 5920 R
English (EN)

12.6 Rotor FA-48x2

Aerosol-tight fixed-angle rotor for 48 tubes

	Max. <i>g</i> -force:	
	Outer ring	21 194 × <i>g</i>
	Inner ring	18 676 × <i>g</i>
	Max. speed:	13 700 rpm
Rotor FA-48x2	Max. load (adapter, tube and contents):	48 × 3.75 <i>g</i>

Tube	Tube Capacity Tubes per adapter/ rotor	Adapter Order no. (international)	Bottom shape Tube diameter	Max. <i>g</i> -force
				Outer ring Inner ring Max. speed Radius Outer ring Inner ring
	PCR tube 0.2 mL 1/48	 5425 715.005	conical Ø 6 mm	16 787 × <i>g</i> 14 269 × <i>g</i> 13 700 rpm 8 cm 6,8 cm
	Micro test tube 0.4 mL 1/48	 5425 717.008	conical Ø 6 mm	21 194 × <i>g</i> 18 676 × <i>g</i> 13 700 rpm 10,1 cm 8.9 cm
	Micro test tube 0.5 mL 1/48	 5425 716.001	– Ø 8 mm	18 885 × <i>g</i> 16 367 × <i>g</i> 13 700 rpm 9 cm 7.8 cm
	Microtainers 0.6 mL 1/48	 5425 716.001	– Ø 8 mm	21 194 × <i>g</i> 18 676 × <i>g</i> 13 700 rpm 10,1 cm 8.9 cm

Tube	Tube Capacity Tubes per adapter/ rotor	Adapter Order no. (international)	Bottom shape Tube diameter	Max. <i>g</i> -force Outer ring Inner ring Max. speed Radius Outer ring Inner ring
	Micro test tube 1.5 mL/2 mL -/48		round Ø 11 mm	21194 × <i>g</i> 18676 × <i>g</i> 13700 rpm 10,1 cm 8.9 cm

13 Ordering information

13.1 Rotors and accessories

The order numbers for the adapters can be found in the chapter "Rotors for Centrifuge 5920 R" (see p. 77).

13.1.1 Rotor S-4xUniversal Large

Order no. (International)	Order no. (North America)	Description
5895 190.006	5895190006	Rotor S-4xUniversal-Large incl. universal buckets
5895 192.009	5895192009	Bucket S-4xUniversal-Large 4 pieces
5920 752.006	5920752006	Aerosol-tight cap Rotor S-4xUniversal-Large, universal buckets 2 pieces
5920 754.009	5920754009	Sealings for aerosol-tight caps Rotor S-4xUniversal-Large, universal buckets 4 pieces
5920 737.007	5920737007	Plate carrier Rotor S-4xUniversal-Large, universal buckets 2 pieces

13.1.2 Rotor S-4x1000

Order no. (International)	Order no. (North America)	Description
5895 100.007	5895100007	Rotor S-4x1000 incl. round bucket
5895 101.003	5895101003	without bucket
5895 103.006	5895103006	Round bucket S-4x1000 2 pieces
5895 102.000	5895102000	4 pieces
5820 747.005	5820747005	Aerosol-tight cap Rotors S-4-104, S-4x750, S-4x1000, round bucket 750 mL/ 1000 mL 2 pieces
5820 749.008	5820749008	Sealings for aerosol-tight caps Rotors S-4-104, S-4x750, S-4x1000, round bucket 750 mL/ 1000 mL 4 pieces

Ordering informationCentrifuge 5920 R
English (EN)

Order no. (International)	Order no. (North America)	Description
5895 118.003	5895118003	Rotor S-4x1000 incl. High-Capacity Buckets
5895 107.001 5895 106.005	5895107001 5895106005	High-Capacity Bucket S-4x1000 2 pieces 4 pieces
5920 729.004	5920729004	Plate carrier Rotor S-4x1000, High-Capacity Bucket 2 pieces

Order no. (International)	Order no. (North America)	Description
5895 117.007	5895117007	Rotor S-4x1000 incl. Plate/Tube Buckets
5895 105.009 5895 104.002	5895105009 5895104002	Plate/Tube Bucket S-4x1000 2 pieces 4 pieces
5895 111.009	5895111009	Aerosol-tight cap Rotor S-4x1000: Plate/Tube Bucket, Rotor S-4x750: Plate Bucket 2 pieces
5820 780.002	5820780002	Sealings for aerosol-tight caps Rotors S-4-104, S-4x750, S-4x1000, Plate/Tube Bucket 4 pieces
5920 705.008	5920705008	Plate carrier Rotor S-4x1000, Plate/Tube Bucket 2 pieces

13.1.3 Rotor S-4x750

Order no. (International)	Order no. (North America)	Description
5895 120.008	5895120008	Rotor S-4x750 incl. round bucket
5895 123.007 5895 122.000	5895123007 5895122000	Round bucket S-4x750 2 pieces 4 pieces
5820 747.005	5820747005	Aerosol-tight cap Rotors S-4-104, S-4x750, S-4x1000, round bucket 750 mL/ 1000 mL 2 pieces
5820 749.008	5820749008	Sealings for aerosol-tight caps Rotors S-4-104, S-4x750, S-4x1000, round bucket 750 mL/ 1000 mL 4 pieces

Order no. (International)	Order no. (North America)	Description
5895 128.009	5895128009	Rotor S-4x750 incl. plate bucket
5895 125.000 5895 124.003	5895125000 5895124003	Plate bucket (aerosol-tight capable) for Rotor S-4x750 2 pieces 4 pieces
5820 748.001	5820748001	Aerosol-tight cap Rotors S-4-104, S-4x750, Plate Bucket 2 pieces
5820 780.002	5820780002	Sealings for aerosol-tight caps Rotors S-4-104, S-4x750, S-4x1000, Plate/Tube Bucket 4 pieces
5820 756.004	5820756004	Plate carrier Rotor S-4-104, S-4x750 2 pieces

13.1.4 Rotor FA-6x50

Order no. (International)	Order no. (North America)	Description
5895 150.004	5895150004	Rotor FA-6x50 aerosol-tight, 6 × 50 mL conical tubes incl. aerosol-tight rotor lid
5895 151.000	5895151000	Rotor lid FA-6x50 aerosol-tight, aluminum
5418 709.008	022652109	Seal for rotor lid FA-45-18-11 (5418/5418 R), FA-45-6-30 (5804/5804 R/5810/ 5810 R), FA-6x50 (5910 R, 5920 R) 5 pieces

13.1.5 Rotor FA-20x5

Order no. (International)	Order no. (North America)	Description
5895 130.003	5895130003	Rotor FA-20x5 aerosol-tight, 20 × 5 mL tubes incl. aerosol-tight rotor lid
5895 131.000	5895131000	Rotor lid FA-20x5 aerosol-tight, aluminum
5409 718.002	5409718002	Seal for rotor lid FA-45-20-17 (5804/5804 R/5810/5810 R), FA-20x5 (5910 R, 5920 R) 5 pieces

Ordering informationCentrifuge 5920 R
English (EN)**13.1.6 Rotor FA-48x2**

Order no. (International)	Order no. (North America)	Description
5895 135.005	5895135005	Rotor FA-48x2 aerosol-tight, 48 × 1,5/2 mL tubes incl. aerosol-tight rotor lid
5895 136.001	5895136001	Rotor lid FA-48x2 aerosol-tight, aluminum
5820 767.006	5820767006	Seal for rotor lid FA-45-24-11-Kit (5427 R/530/5430 R), FA-45-48-11 (5427 R/5430/5430 R, 5804/5804 R/5810/5810 R), FA-30x2 (5910 R, 5920 R), FA-48x2 (5910 R, 5920 R) 5 pieces

13.2 Accessories

Order no. (International)	Order no. (North America)	Description
0113 005.106	–	Rotor key
0113 204.486	–	Mains/power cord 230 V/50 Hz, Europe
0113 204.680	–	230 V/50 Hz, GB/HK
0013 613.953	–	230 V/50 Hz, CN
0113 204.699	–	230 V/50 Hz, AUS
0113 206.292	022664999	100 V/120 V, 50 Hz/60 Hz, USA, JP
0113 205.105	–	230 V/50 Hz, ARG
5810 350.050	022634330	Pivot grease Tube 20 mL

Declaration of Conformity

The product named below fulfills the requirements of directives and standards listed. In the case of unauthorized modifications to the product or an unintended use this declaration becomes invalid. This declaration of conformity is issued under the sole responsibility of the manufacturer.

Product name:

Centrifuge 5920 R

including components

Product type:

Centrifuge

Relevant directives / standards:

2006/42/EC: EN ISO 12100

2014/35/EU: EN 61010-1, EN 61010-2-020

UL 61010-1, CAN/CSA C22.2 No. 61010-1, IEC 61010-1, IEC 61010-2-020

2014/30/EU: EN 61326-1, EN 55011

47 CFR FCC part 15

2014/68/EU: EN 378-1, EN 378-2

2011/65/EU: EN 50581

Person authorized to compile

the technical file acc. to 2006/42/EC: Dr. Reza Hashemi
Executive Director Portfolio Management Centrifugation
Eppendorf AG

Hamburg, October 17, 2017



Dr. Wilhelm Plüster
Management Board



Dr. Reza Hashemi
Portfolio Management

Your local distributor: www.eppendorf.com/contact
Eppendorf AG · Barkhausenweg 1 · 22339 Hamburg · Germany
eppendorf@eppendorf.com

Eppendorf® and the Eppendorf Brand Design are registered trademarks of Eppendorf AG, Germany.
All rights reserved, incl. graphics and pictures. Copyright ©2017 by Eppendorf AG.

www.eppendorf.com

ISO
9001
Certified

ISO
13485
Certified

ISO
14001
Certified

5948 900.418-00

CERTIFICATE OF COMPLIANCE

Certificate Number 20150309-E215059
Report Reference E215059-A7-UL
Issue Date 2015-MARCH-09

Issued to: EPPENDORF A G
BARKHAUSENWEG 1
22339 HAMBURG GERMANY

This is to certify that representative samples of LABORATORY USE ELECTRICAL EQUIPMENT
Centrifuge 5948 (5920 R)

Have been investigated by UL in accordance with the Standard(s) indicated on this Certificate.

Standard(s) for Safety: UL 61010-1 Safety Requirements For Electrical Equipment For Measurement, Control, And Laboratory Use - Part 1: General Requirements
CAN/CSA C22.2 NO. 61010-1 Safety Requirements For Electrical Equipment For Measurement, Control, And Laboratory Use — Part 1: General Requirements

Additional Information: See the UL Online Certifications Directory at www.ul.com/database for additional information

Only those products bearing the UL Certification Mark should be considered as being covered by UL's Certification and Follow-Up Service.

Look for the UL Certification Mark on the product.



Bruce Mahrenholz, Assistant Chief Engineer, Global Inspection and Field Services

UL LLC

Any information and documentation involving UL Mark services are provided on behalf of UL LLC (UL) or any authorized licensee of UL. For questions, please contact a local UL Customer Service Representative at <http://ul.com/aboutul/locations/>





Certificate of Containment Testing

Containment Testing of Rotor S-4xuniversal-large (5895 190.103-00) with Universal Buckets (5895 192.114-00*) and Caps (5920 752.103-00[#]) in an Eppendorf Bench Top Centrifuge

Report No. 16/009 A

Report Prepared For: Eppendorf AG, Hamburg, Germany

Issue Date: 04 July 2016

Test Summary

Rotor S-4xuniversal-large (5895 190.103-00) with Universal Buckets (5895 192.114-00*) and Caps (5920 752.103-00[#]) was containment tested in an Eppendorf bench top centrifuge, using Annex AA of IEC 61010-2-020:2006 (2nd Ed.). The sealed buckets were shown to contain a spill.

Report Written By

Name: Ms Anna Moy

Title: Biosafety Scientist

Report Authorised By

Name: Mrs Sara Speight

Title: Senior Biosafety Scientist

Please be aware that the use of the Royal Coat of Arms is highly restricted and cannot be copied. Please do not put the PHE logo on your website or use our name to endorse your products. Any reference to PHE needs to be approved by us before it can be used.

* Part no. will form part of catalogue number 5895 190.006; 5895 192.009; 5895 193.005

Part no. will form part of catalogue number 5920 752.006



Certificate of Containment Testing

Containment Testing of Rotor S-4x1000 (5895 100.104-00) with Roundbuckets (5895 102.115-00*) and Caps (5820 741.309-00[#]) in an Eppendorf Bench Top Centrifuge

Report No. 14/034

Report Prepared For: Eppendorf AG, Hamburg, Germany

Issue Date: 17th February 2015

Test Summary

Rotor S-4x1000 (5895 100.104-00) with Roundbuckets (5895 102.115-00*) and Caps (5820 741.309-00[#]) was containment tested in an Eppendorf bench top centrifuge, using Annex AA of IEC 61010-2-020:2006 (2nd Ed.). The sealed bucket was shown to contain a spill.

Report Written By

Name: Ms Anna Moy

Title: Biosafety Scientist

Report Authorised By

Name: Mrs Sara Speight

Title: Senior Biosafety Scientist



Public Health
England

Public Health England
Microbiology Services
Porton Down
Salisbury
Wiltshire
SP4 OJG

Certificate of Containment Testing

Containment Testing of Rotor S-4x1000 (5895 100.104-00) with Plate Buckets (5895 104.118-00*) and Caps (5895 104.304-00[#]) in an Eppendorf Bench Top Centrifuge

Report No. 14/044 B

Report Prepared For: Eppendorf AG, Hamburg, Germany

Issue Date: 17th February 2015

Test Summary

Rotor S-4x750 (5895 100.104-00) with Plate Buckets (5895 104.118-00*) and Caps (5895 104.304-00[#]) was containment tested in an Eppendorf bench top centrifuge, using Annex AA of IEC 61010-2-020:2006 (2nd Ed.). The sealed buckets were shown to contain a spill.

Report Written By

Name: Ms Anna Moy

Title: Biosafety Scientist

Report Authorised By

Name: Mrs Sara Speight

Title: Senior Biosafety Scientist

Please be aware that the use of the Royal Coat of Arms is highly restricted and cannot be copied. Please do not put the PHE logo on your website or use our name to endorse your products. Any reference to PHE needs to be approved by us before it can be used.

* Part no. will form part of catalogue number 5895 117.007; 5895 104.002; 5895 105.009

Part no. will form part of catalogue number 5885 111.009



Certificate of Containment Testing

Containment Testing of Rotor S-4x1000 (5895 100.104-00) with DWP Buckets (5895 104.118-00*) and Caps (5820 743.301-00[#]) in an Eppendorf Bench Top Centrifuge

Report No. 14/044 A

Report Prepared For: Eppendorf AG, Hamburg, Germany

Issue Date: 17th February 2015

Test Summary

Rotor S-4x750 (5895 100.104-00) with DWP Buckets (5895 104.118-00*) and Caps (5820 743.301-00[#]) was containment tested in an Eppendorf bench top centrifuge, using Annex AA of IEC 61010-2-020:2006 (2nd Ed.). The sealed buckets were shown to contain a spill.

Report Written By

Name: Ms Anna Moy

Title: Biosafety Scientist

Report Authorised By

Name: Mrs Sara Speight

Title: Senior Biosafety Scientist

Please be aware that the use of the Royal Coat of Arms is highly restricted and cannot be copied. Please do not put the PHE logo on your website or use our name to endorse your products. Any reference to PHE needs to be approved by us before it can be used.

* Part no. will form part of catalogue number 5895 117.007; 5895 104.002; 5895 105.009

Part no. will form part of catalogue number 5820 748.001



Certificate of Containment Testing

Containment Testing of Caps (5820 741.309-00) for Rotor S- 4x750 with Roundbuckets (5895 102.115-00) in the Eppendorf 5920/R Bench Top Centrifuge

Report No. 14/014

Report Prepared For: Eppendorf AG, Hamburg, Germany

Issue Date: 26th June 2014

Test Summary

Caps (5820 741.309-00) for rotor S-4x750 with Roundbuckets (5895 102.115-00) were containment tested in the Eppendorf 5920/R bench top centrifuge, using Annex AA of IEC 61010-2-020:2006 (2nd Ed.). The sealed rotor was shown to contain a spill within the centrifuge.

Report Written By

Name: Mr Matthew Hewitt

Title: Biosafety Scientist

Report Authorised By

Name: Mrs Sara Speight

Title: Senior Biosafety Scientist



Public Health
England

Public Health England
Microbiology Services
Porton Down
Salisbury
Wiltshire
SP4 OJG

Certificate of Containment Testing

Containment Testing of Rotor S-4x750 (5895 120.105-00) with Plate Buckets (5895 124.119-00*) and Caps (5895 104.304-00[#]) in an Eppendorf Bench Top Centrifuge

Report No. 14/043 B

Report Prepared For: Eppendorf AG, Hamburg, Germany

Issue Date: 17th February 2015

Test Summary

Rotor S-4x750 (5895 120.105-00) with Plate Buckets (5895 124.119-00*) and Caps (5895 104.304-00[#]) was containment tested in an Eppendorf bench top centrifuge, using Annex AA of IEC 61010-2-020:2006 (2nd Ed.). The sealed buckets were shown to contain a spill.

Report Written By

Name: Ms Anna Moy

Title: Biosafety Scientist

Report Authorised By

Name: Mrs Sara Speight

Title: Senior Biosafety Scientist

Please be aware that the use of the Royal Coat of Arms is highly restricted and cannot be copied. Please do not put the PHE logo on your website or use our name to endorse your products. Any reference to PHE needs to be approved by us before it can be used.

* Part no. will form part of catalogue number 5895 128.009; 5895 124.003; 5895 125.000

Part no. will form part of catalogue number 5895 111.009



Public Health
England

Public Health England
Microbiology Services
Porton Down
Salisbury
Wiltshire
SP4 OJG

Certificate of Containment Testing

Containment Testing of Rotor S-4x750 (5895 120.105-00) with Plate Buckets (5895 124.119-00*) and Caps (5820 743.301-00[#]) in an Eppendorf Bench Top Centrifuge

Report No. 14/043 A

Report Prepared For: Eppendorf AG, Hamburg, Germany

Issue Date: 17th February 2015

Test Summary

Rotor S-4x750 (5895 120.105-00) with Plate Buckets (5895 124.119-00*) and Caps (5820 743.301-00[#]) was containment tested in an Eppendorf bench top centrifuge, using Annex AA of IEC 61010-2-020:2006 (2nd Ed.). The sealed buckets were shown to contain a spill.

Report Written By

Name: Ms Anna Moy

Title: Biosafety Scientist

Report Authorised By

Name: Mrs Sara Speight

Title: Senior Biosafety Scientist

Please be aware that the use of the Royal Coat of Arms is highly restricted and cannot be copied. Please do not put the PHE logo on your website or use our name to endorse your products. Any reference to PHE needs to be approved by us before it can be used.

* Part no. will form part of catalogue number 5895 128.009; 5895 124.003; 5895 125.000

Part no. will form part of catalogue number 5820 748.001



Certificate of Containment Testing

Containment Testing of Rotor FA-6x50 (5895 150.101-00*) in an Eppendorf Bench Top Centrifuge

Report No. 14/029 A

Report Prepared For: Eppendorf AG, Hamburg, Germany

Issue Date: 17th February 2015

Test Summary

Rotor FA-6x50 (5895 150.101-00*) was containment tested in an Eppendorf bench top centrifuge, using Annex AA of IEC 61010-2-020:2006 (2nd Ed.). The sealed rotor was shown to contain a spill.

Report Written By

Name: Ms Anna Moy

Title: Biosafety Scientist

Report Authorised By

Name: Mrs Sara Speight

Title: Senior Biosafety Scientist

Please be aware that the use of the Royal Coat of Arms is highly restricted and cannot be copied. Please do not put the PHE logo on your website or use our name to endorse your products. Any reference to PHE needs to be approved by us before it can be used.



Certificate of Containment Testing

Containment Testing of Rotor FA-20x5 (5895 130.100-00*) in an Eppendorf Bench Top Centrifuge

Report No. 14/029 B

Report Prepared For: Eppendorf AG, Hamburg, Germany

Issue Date: 17th February 2015

Test Summary

Rotor FA-20x5 (5895 130.100-00*) was containment tested in an Eppendorf bench top centrifuge, using Annex AA of IEC 61010-2-020:2006 (2nd Ed.). The sealed rotor was shown to contain a spill.

Report Written By

Name: Ms Anna Moy

Title: Biosafety Scientist

Report Authorised By

Name: Mrs Sara Speight

Title: Senior Biosafety Scientist



Public Health
England

Public Health England
Microbiology Services
Porton Down
Salisbury
Wiltshire
SP4 OJG

Certificate of Containment Testing

Containment Testing of Rotor FA-48x2 (5895 135.102-00*) in an Eppendorf Bench Top Centrifuge

Report No. 14/029 C

Report Prepared For: Eppendorf AG, Hamburg, Germany

Issue Date: 17th February 2015

Test Summary

Rotor FA-48x2 (5895 135.102-00*) was containment tested in an Eppendorf bench top centrifuge, using Annex AA of IEC 61010-2-020:2006 (2nd Ed.). The sealed rotor was shown to contain a spill.

Report Written By

Name: Ms Anna Moy

Title: Biosafety Scientist

Report Authorised By

Name: Mrs Sara Speight

Title: Senior Biosafety Scientist

Please be aware that the use of the Royal Coat of Arms is highly restricted and cannot be copied. Please do not put the PHE logo on your website or use our name to endorse your products. Any reference to PHE needs to be approved by us before it can be used.

Evaluate Your Manual

Give us your feedback.

www.eppendorf.com/manualfeedback

Your local distributor: www.eppendorf.com/contact

Eppendorf AG · Barkhausenweg 1 · 22339 Hamburg · Germany
eppendorf@eppendorf.com · www.eppendorf.com