

**INOVIALAB**

**Real-Time PCR Systems  
GenX-4, GenX-6**



# Real-Time PCR System



INOVIALAB GenX is based on global vision of product design concepts and manufacturing processes. It creatively combines Fresnel lens optical signal acquisition technology, time-resolved signal separation technology and unique temperature control technology. And it reaches international advanced level in sensitivity, multi-color crosstalk, temperature uniformity and accuracy. It supports the application of all common QPCR detection modes.

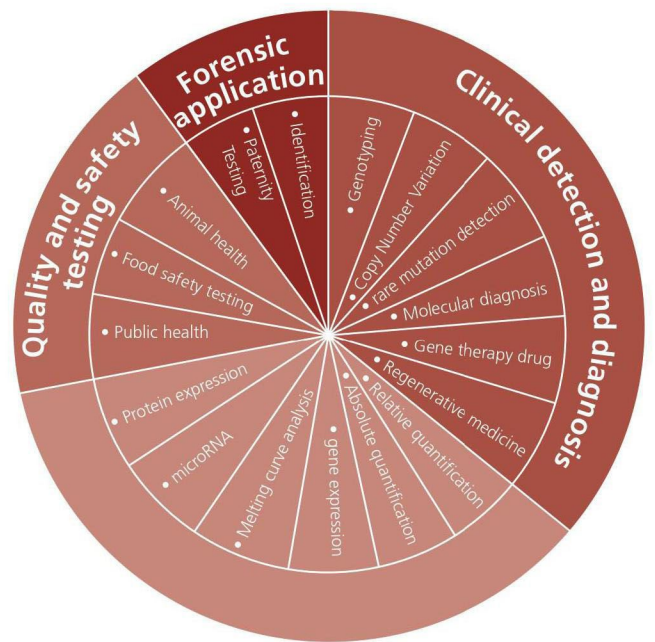

## Up to 6 fluorescence detection channels allowing multiplex PCR Simultaneous detection of 5 target genes in 96 samples

Channel 6	Channel 5	Channel 4
NED™ /Cy3/ TAMRA™	ROX™ /Texas Red®	FAM™ /SYBR
VIC® / HEX™ /TET/ JOE™	Cy5® /Quasar® 670	FAM™ /SYBR
Channel 3	Channel 2	Channel 1

FAM,JOE,VIC,HEX,NED,TAMRA and ROX are trademarks of Life Technologies Corporation and its subsidiaries. VIC and Texas Red are registered trademarks of Life Technologies Corporation and its subsidiaries. Cy5 is a registered trademark of GE Healthcare Bio-Sciences Corp. Quasar are registered trademarks of Biosearch Technologies, Inc.

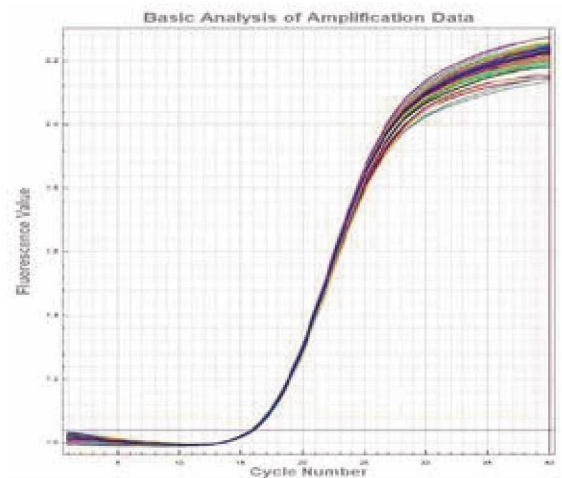

Simultaneous scanning of the six-channel shows that the standard deviation of the Ct value of the FAM channel is <0.07. No fluorescence signal in other channels.

# Real-Time PCR System

## Technical Innovation 1

### Effectively reduce multi-color crosstalk and edge effect, no ROX correction required

The multi-color crosstalk caused by the small sample spacing of 96 or 384-well plates has a great influence on the accuracy of the experimental results, especially in multiplex qPCR detection.

The new optical signal detection system and unique time-resolved scanning can reduce non-target sample optical signal collection. Thereby high repeatability of single fluorescent channel can be ensured.

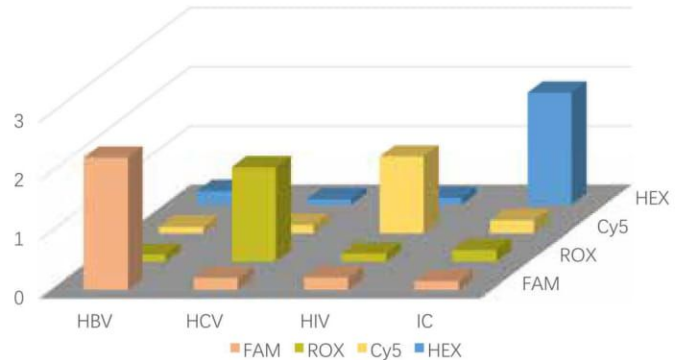
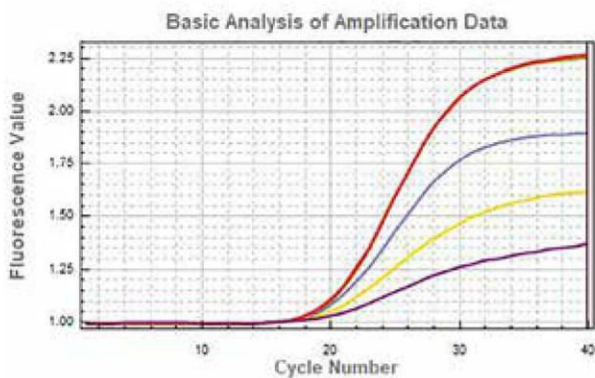

Four different target genes (2 repeats) of FAM/HEX/ROX/Cy5 were simultaneously detected in one reaction tube, and the results showed that there was almost no cross-interference between the different channels.

## New optical scanning detection system - High sensitivity /resolution

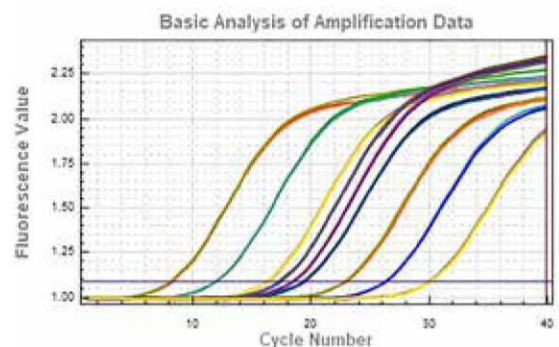
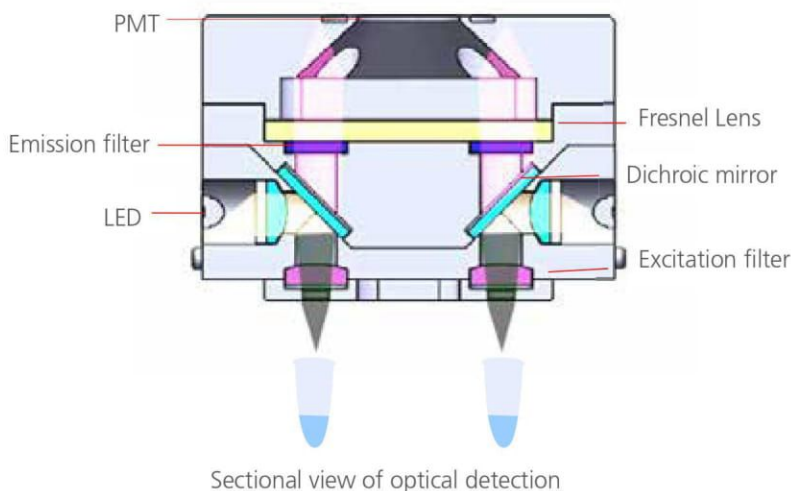

- LED light source Efficient and maintenance-free
- Fresnel Lens It greatly reduces the light collection of the non-target area. And the relative position of the detector to the block hole ensures that one optical detection channel is aligned with one target to be tested at the bottom.

Different concentrations of plasmids were amplified by probe assay (concentration from left to right is 5  $\mu$ g, 500 ng, 50 ng, 20 ng, 10 ng, 5 ng, 500 pg, 50 pg, 5 pg), three replicates for per concentration. The Ct values difference of the 10-fold dilution is exactly 3.3. The Ct values difference of the 2-fold dilution is exactly 1.

# Real-Time PCR System

## Innovative scanning method and time-resolved signal separation technology - High accuracy

- Unique time-resolved scanning method  
The different fluorescence signals of the same sample are collected at different times.  
The high-speed stepping motor and the highly sensitive detector ensure that all signal acquisition of the entire sample plate is completed in a short time.
- Innovative detection channel arrangement Interlaced arrangement of upper and lower channels further reduces inter-hole and multi-color fluorescence crosstalk.
- Double FAM scanning for melting curve Scan time is shortened a lot.

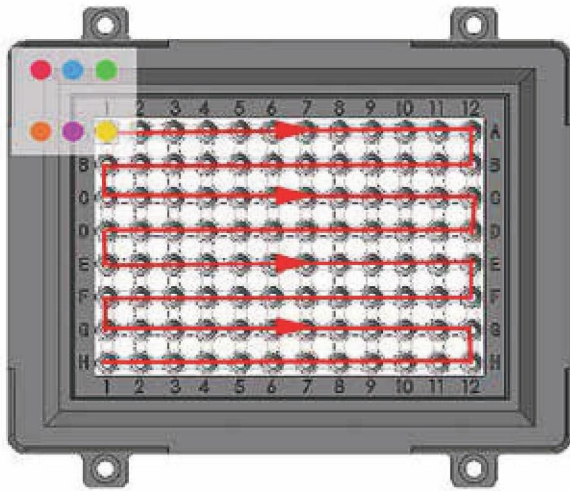

Multi-channel scanning for probe assay

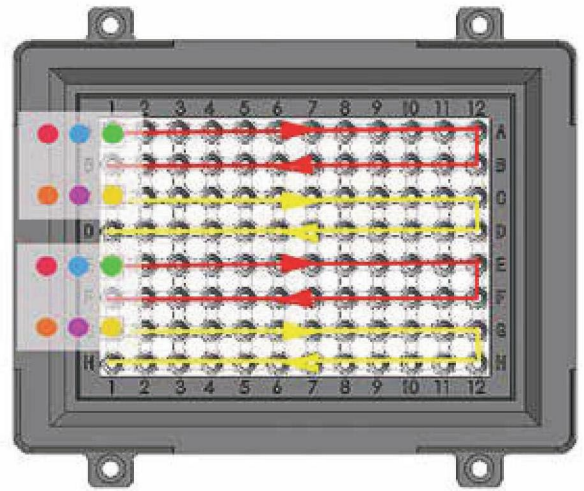

Double FAM scanning for melting curve

## Technical Innovation 2

### Unique edge temperature compensation technology

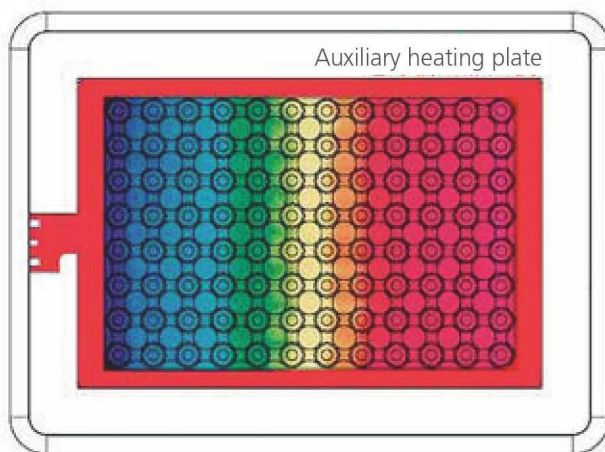

- Both temperature accuracy and uniformity are  $\pm 0.2^{\circ}\text{C}$
- Module maximum ramp rate is  $6^{\circ}\text{C} / \text{sec}$
- The average sample ramp rate is  $2.2^{\circ}\text{C} / \text{sec}$
- With a unique outframe protection design, the unit can achieve very even temperature across the whole plate. Effectively reduce the edge temperature variance.



# Real-Time PCR System



The  $T_m$  values of 96 replicate wells were detected. The results showed that the temperature uniformity difference was  $< \pm 0.2^\circ\text{C}@81^\circ\text{C}$ .

Temperature profile of 96-well plate

Temperature ( $^\circ\text{C}$ )

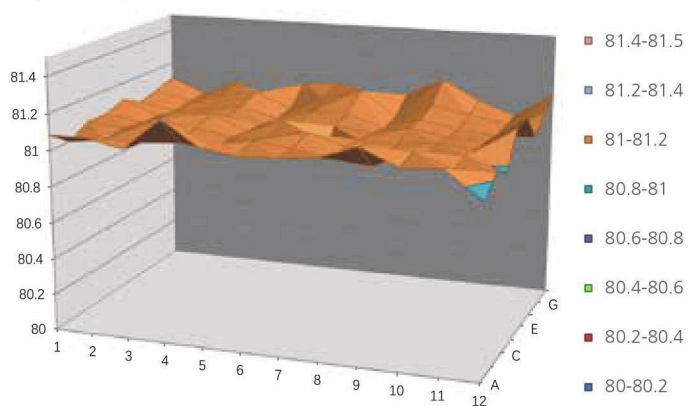

$T_m$  value normal distribution map of 96-well plate

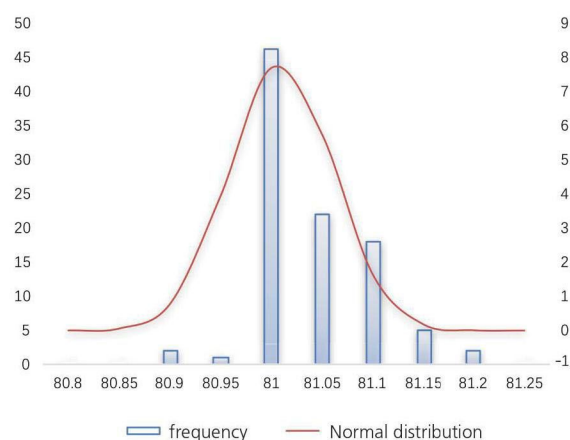

The melting curves of 48 replicate samples

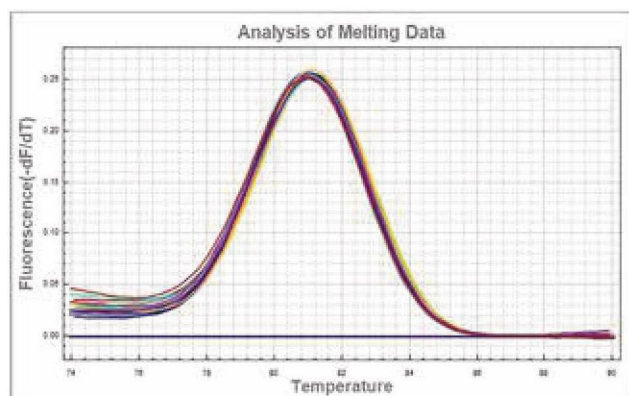
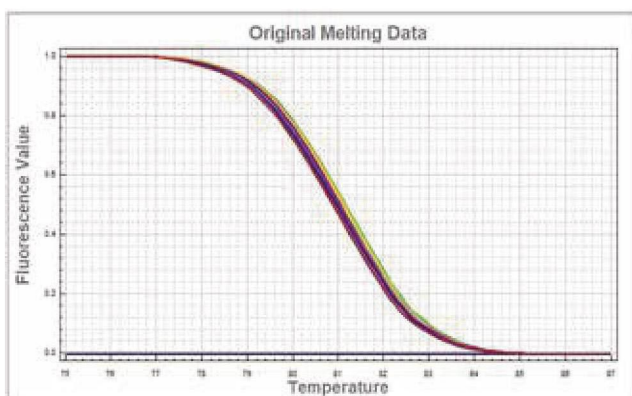

# Real-Time PCR System

## User-friendly software



Free software upgrades

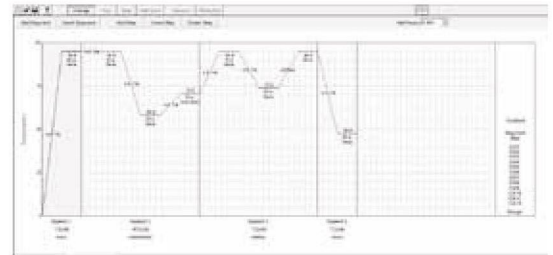

The software can provide you with a full range of solutions for sample detection and result analysis.

## One-stop process and solution



Sample preparation and nucleic acid extraction



Prepare PCR mixture

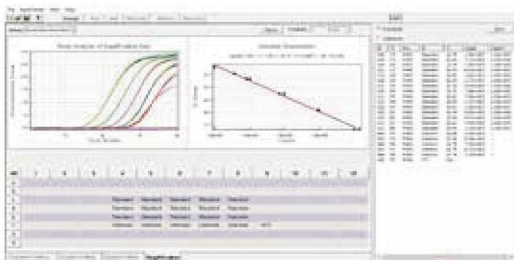

Data analysis



QPCR detection

## Classic Examples

### Swine fever virus ASFV detection

QPCR was used to detect the swine fever virus DNA in vitro for clinical diagnosis of suspected diseased pigs.

**Kit:** Swine fever virus (ASFV) nucleic acid detection kit (PCR probe assay) 、 DNA extraction kit (Spin column method)

**Method:** 5 mL of blood was extract from a live pig syringe to be examined. DNA was extracted by DNA extraction kit. According to the ASFV detection kit operation method, the extracted DNA, the positive control substance, and the negative control substance is separately added to the PCR reaction solution and the enzyme. Then the mixture is centrifuged and tested on real-time qPCR. The reporter and quencher of the TaqMan probe is FAM and TAMRA.

**Judgment basis:** Positive:  $Ct \leq 35$ , and the amplification curve has a significant exponential growth curve. Negative:  $Ct > 37$ , or no significant amplification of the curve. Recommended retest:  $35 < Ct \leq 37$ .

**Data analysis:** The Ct value of the positive control is 20, and the negative control product has no obvious amplification curve. The Ct values of the sample 1 and 2 to be tested is 26 and 30 respectively. According to the judgment basis of the kit, the samples to be tested are ASFV positive.

#### Program :

Step	Temperature	Time	Cycle	End point
1	95°C	10min	1	No
2	94°C	15sec	40	No
	55°C	30sec		Yes

#### Amplification curve:

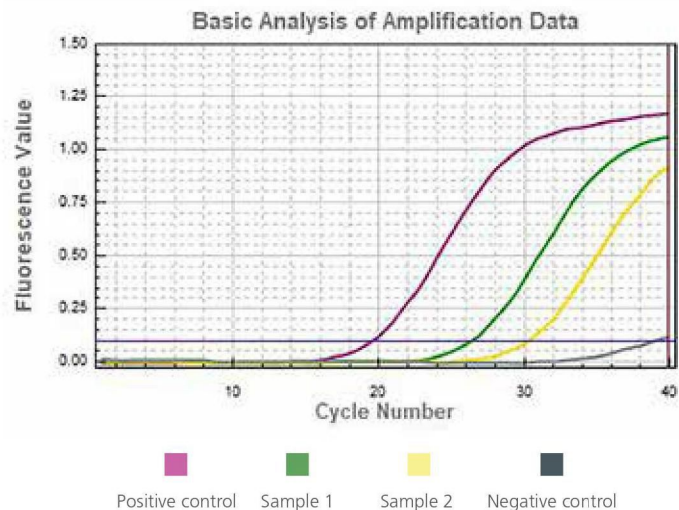

#### Technical Parameters

Temperature control system		Detection system	
Sample capacity	0.1ml PCR tubes×96, 8×12 PCR plate or 96 well plate ×1	Excitation light source	4/6 monochrome high efficiency LEDs
Reaction volume	10-50 μl	Detection device	PMT
Thermal cycle technology	Peltier	Detection mode	Time-resolved signal separating technology
Max. Heating/Cooling rate	6.0° C/s	Excitation/detection wavelength range	455-650nm/510-715nm
Heating temperature range	4 – 100 °C	Fluorescent channels	4/6 channels
Temperature accuracy	± 0.2°C	Supported dye	FAM/SYBR Green, VIC/JOE/HEX/TET, ABY/NED/TAMRA/Cy3, JUN, ROX/ Texas Red, Mustang Purple, Cy5/LIZ
Temperature uniformity	±0.2°C @60°C , ±0.2°C @95°C	Sensitivity	Single copy gene
Temperature gradient setting range	30–100°C	Resolution	1.33 folds copy number difference can be distinguished in single-plex qPCR
Temperature gradient difference setting range	1 – 36°C	Dynamic range	10 orders of magnitude copies

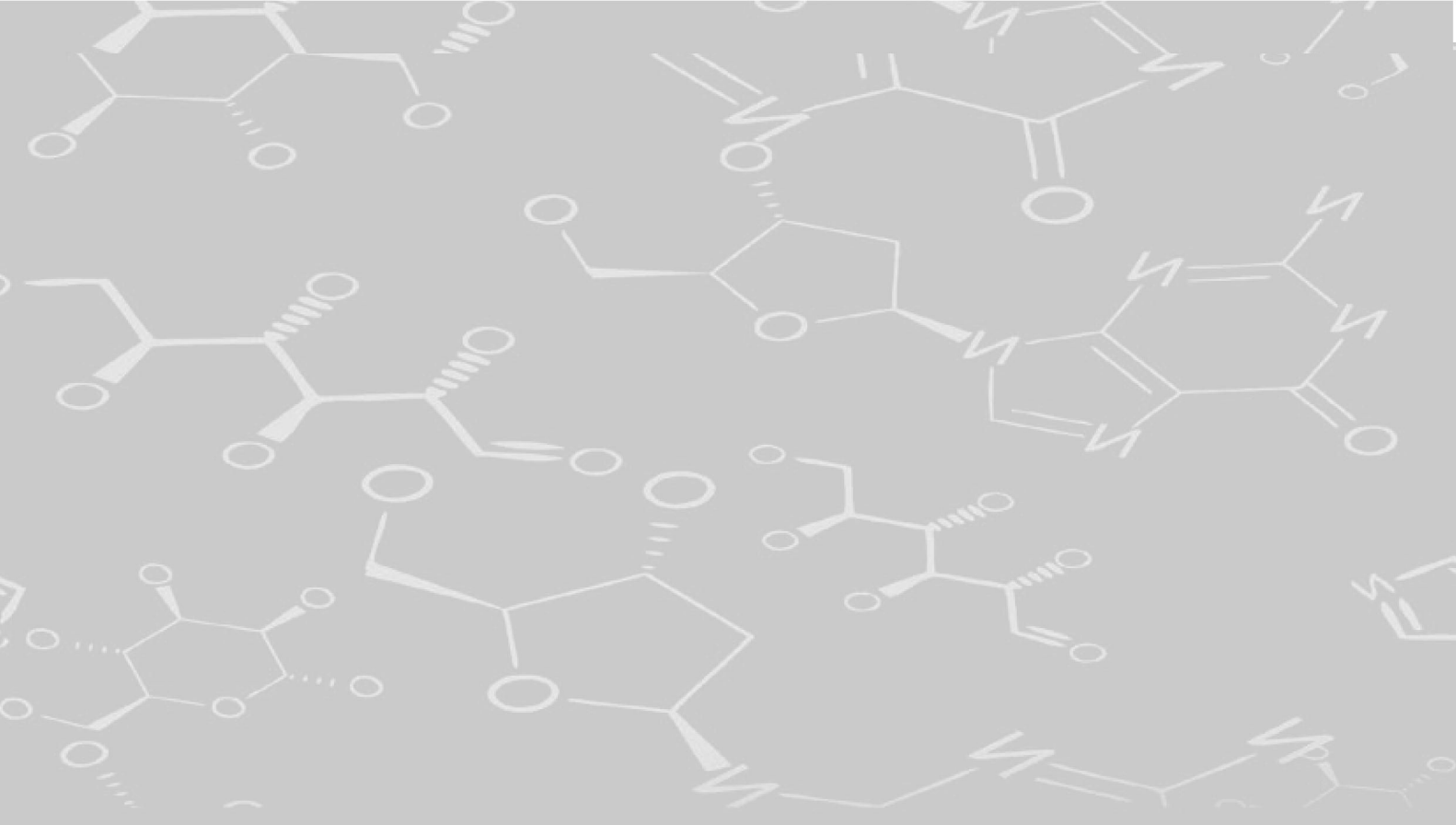

# INOVIALAB

## INOVIA TECHNOLOGY

Address: Oruçreis Mah. Giyimkent 7.Sokak No:115

Posta Kodu: 34235

Esenler / İstanbul / Türkiye

Tel : +90 (212) 210 01 17

Fax : +90 (212) 210 01 18

Web : [www.inovia.com.tr](http://www.inovia.com.tr)

E-Posta : [info@inovia.com.tr](mailto:info@inovia.com.tr)